



1702
UF120X



1703
UF45N



1704
UF60N



1705
UF80N



1706
UF100X



1707
UE25 R-25

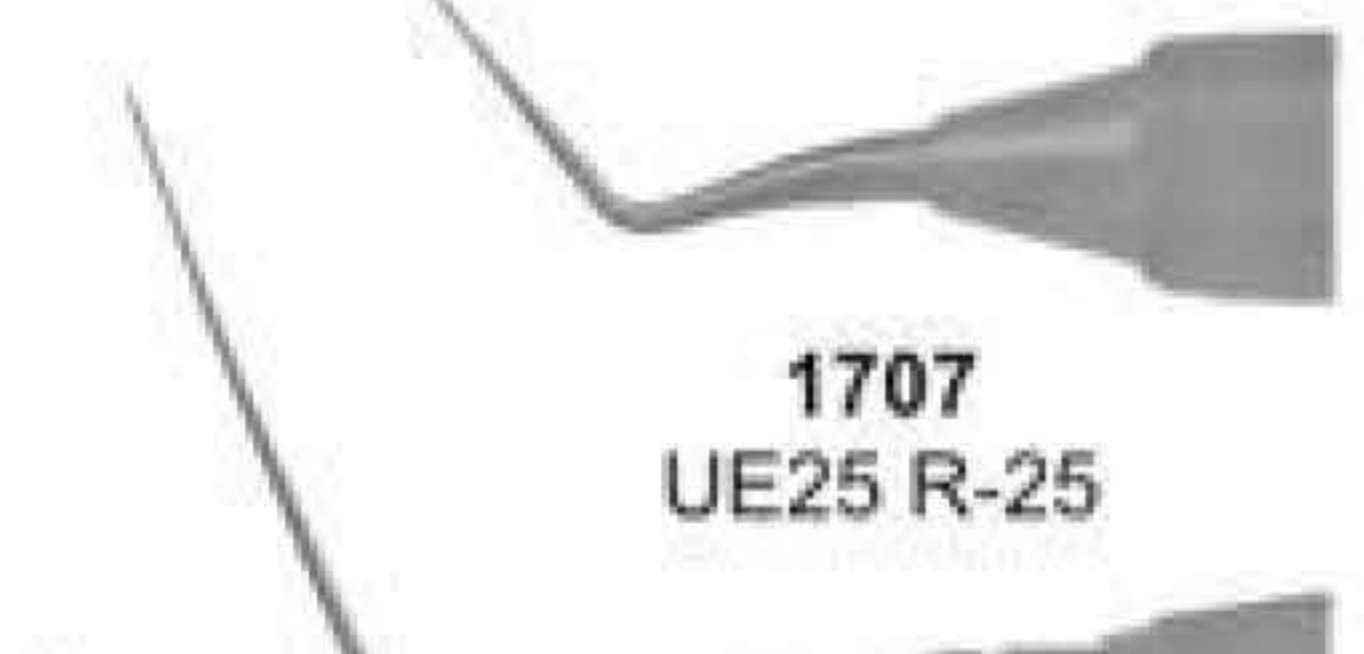

1708
UE30 R-30



1709
UE35 R-35



1710
UE40 R-40



1711
UE45 R-45



1712
UE50 R-50



1713
UF120X

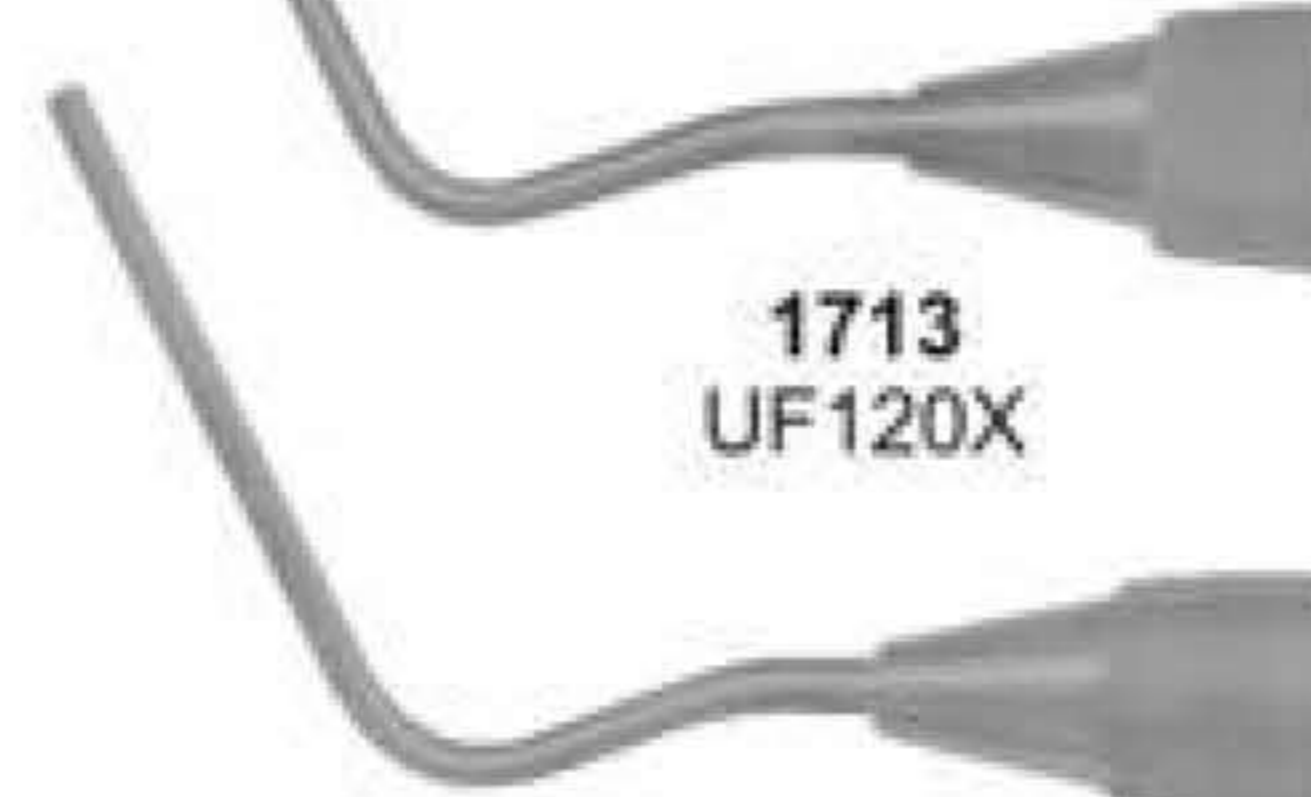

1714
UF140X



1715
TFD3545N



1716
TFD6080N



1717
UE55 R-55



1718
UE60 R-60



1719
UE25N R-25



1720
UE30N R-30



1721
UE40N R-40

1722
No. D11



1723
No. D11T



1724
No. KR1



1725
No. 25S



1726
No. W1S



1727
No. W2S

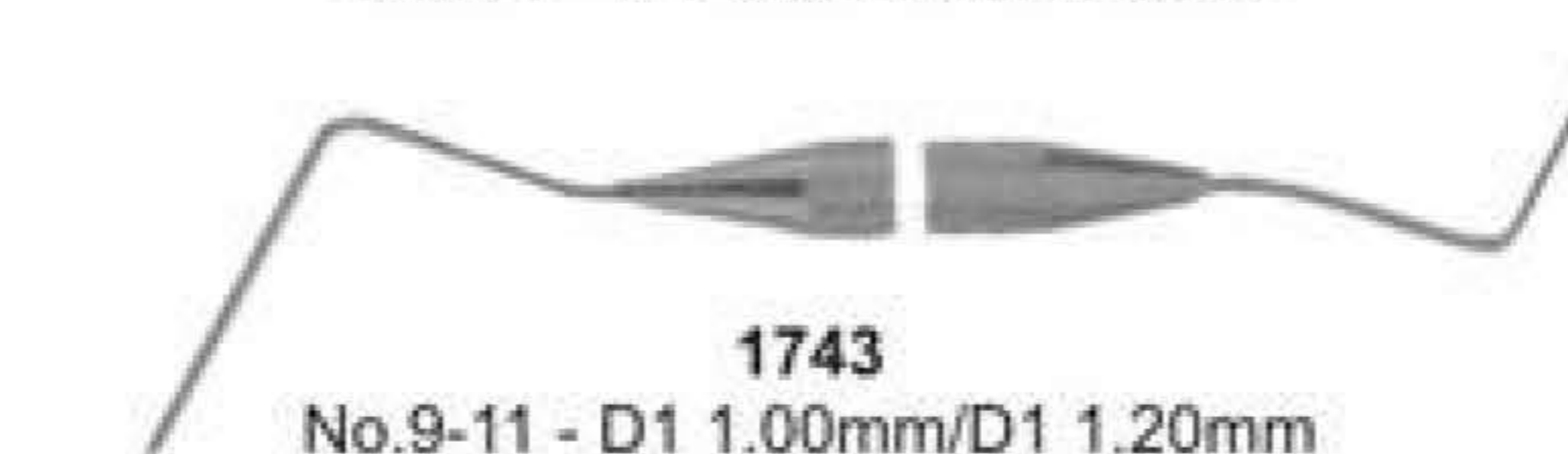
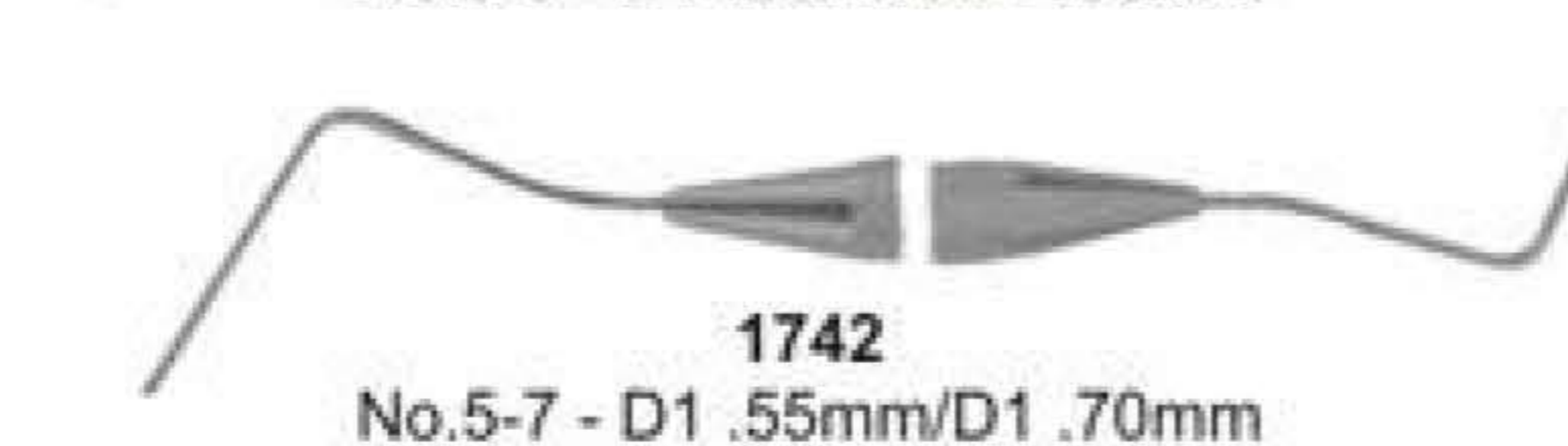
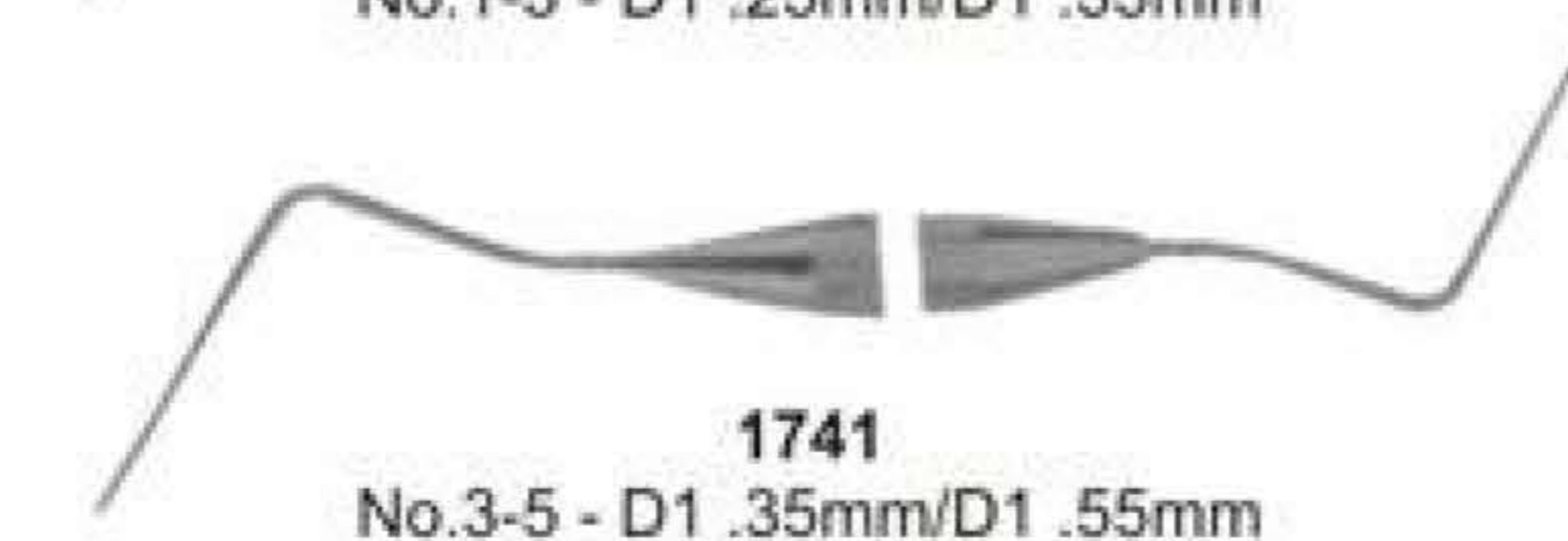
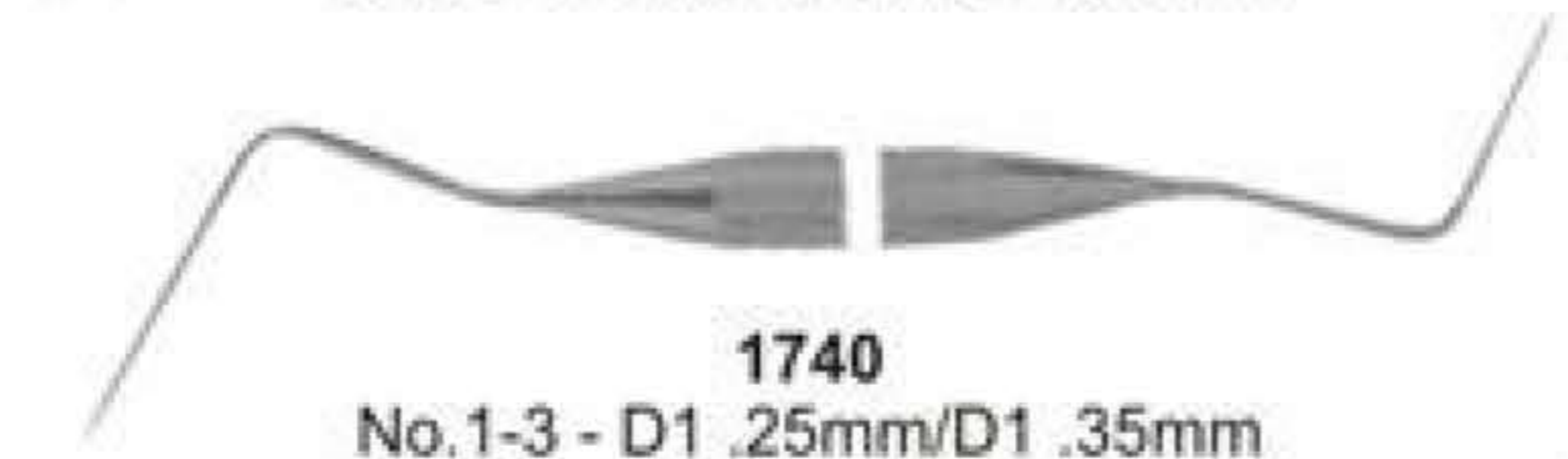
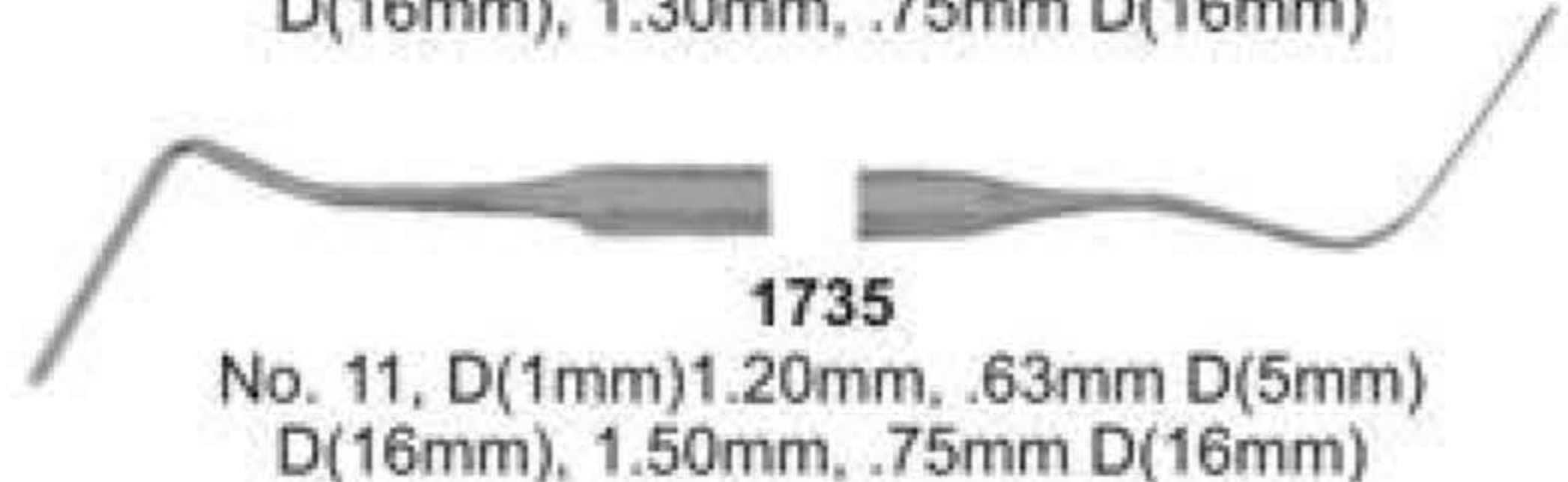
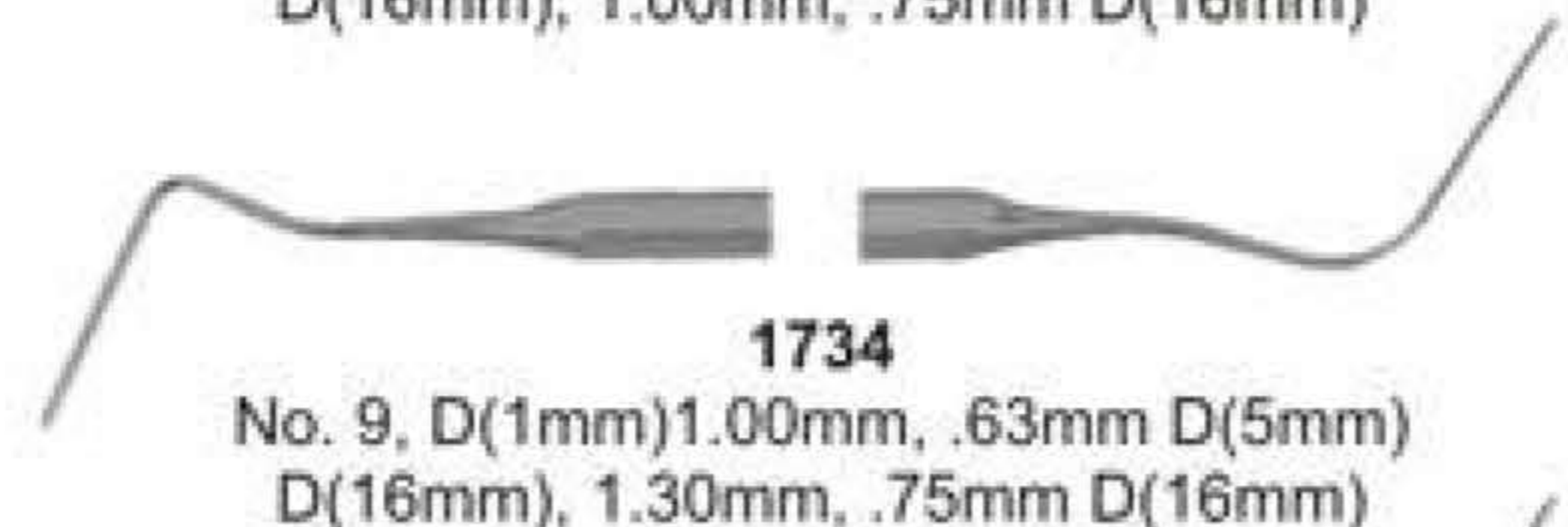
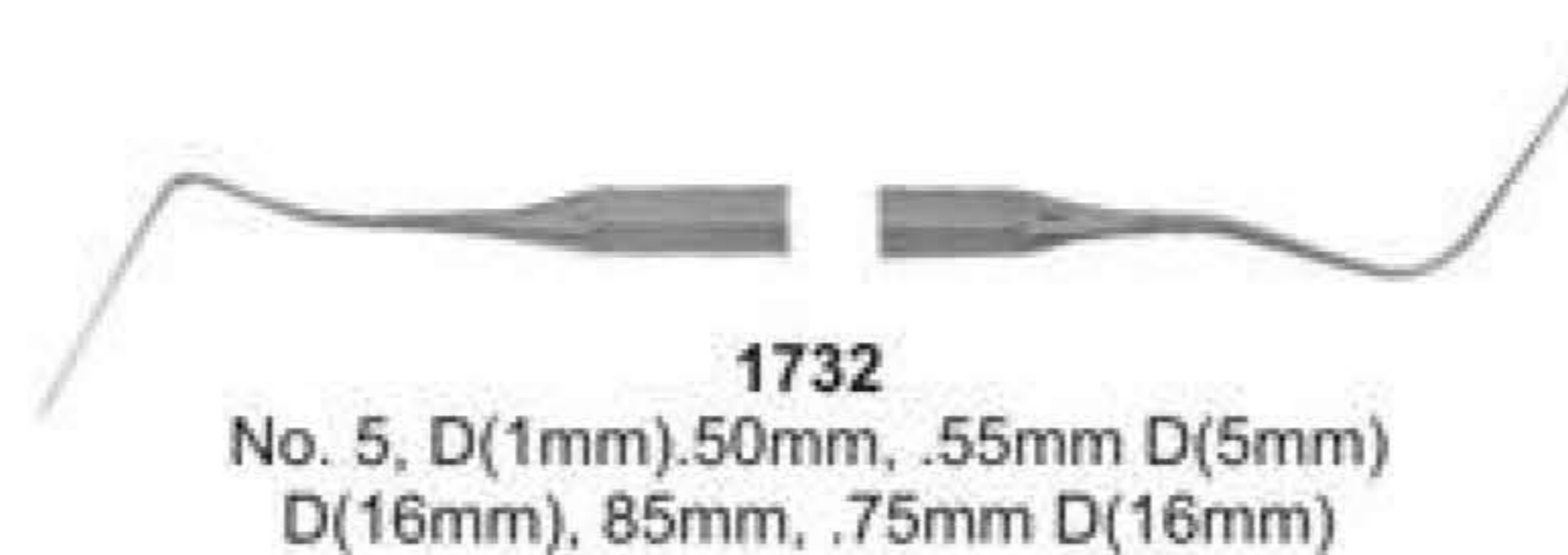

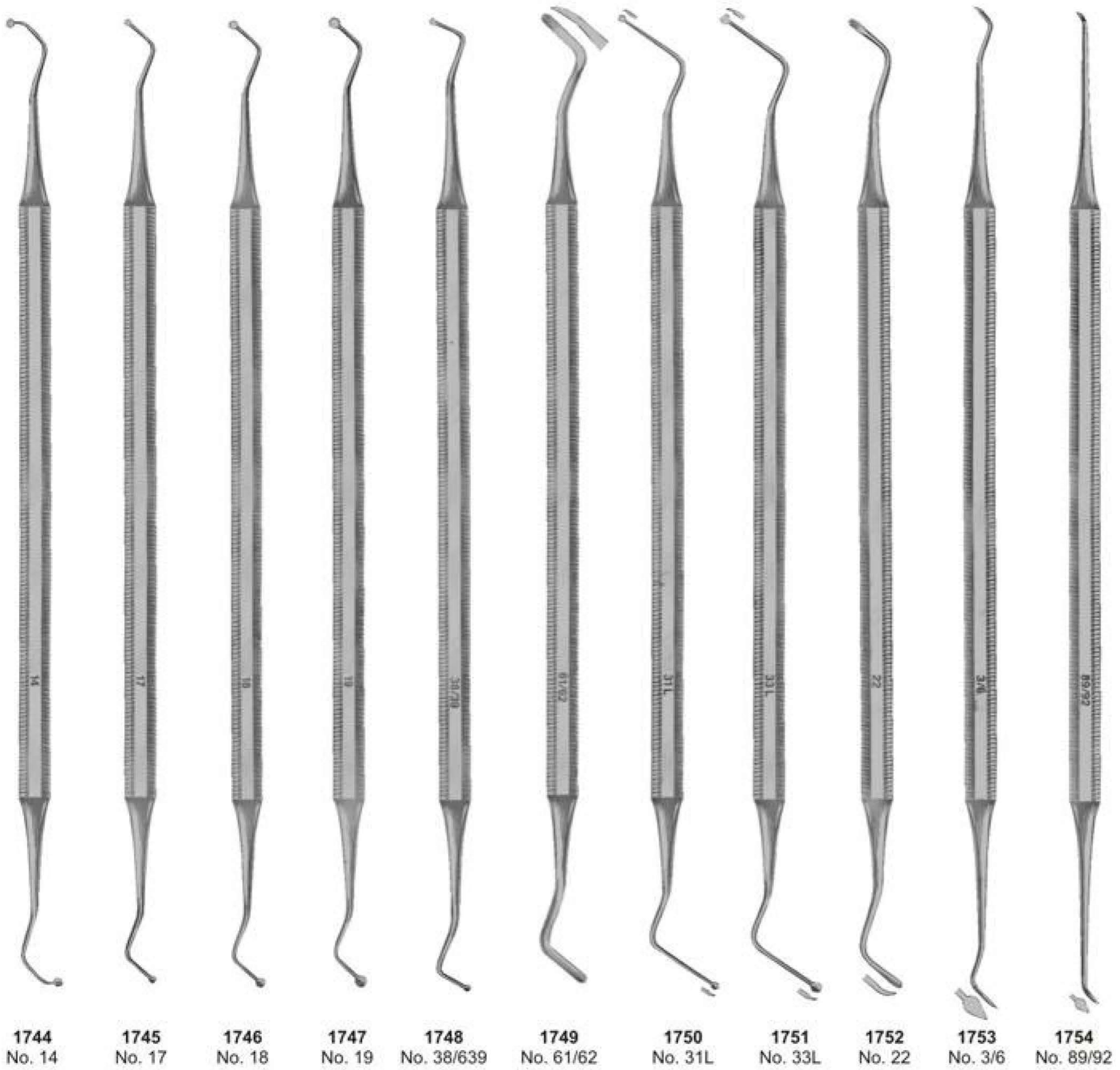

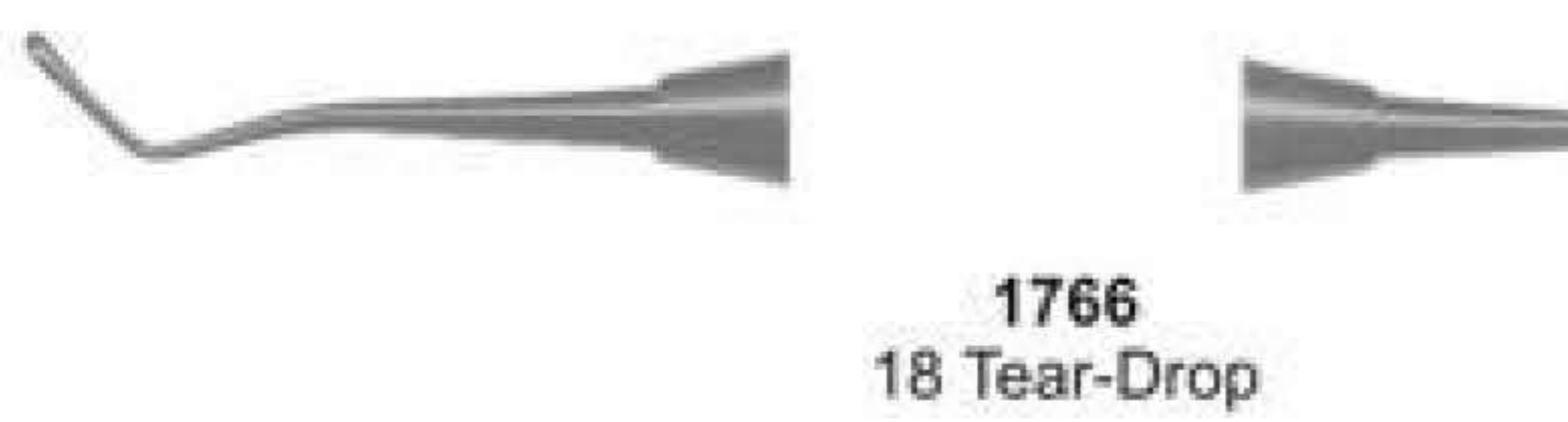

Excavators



1768
31L



1769
31W



1770
33L



1771
32L



Explorers / Probes



1772
G16D-L

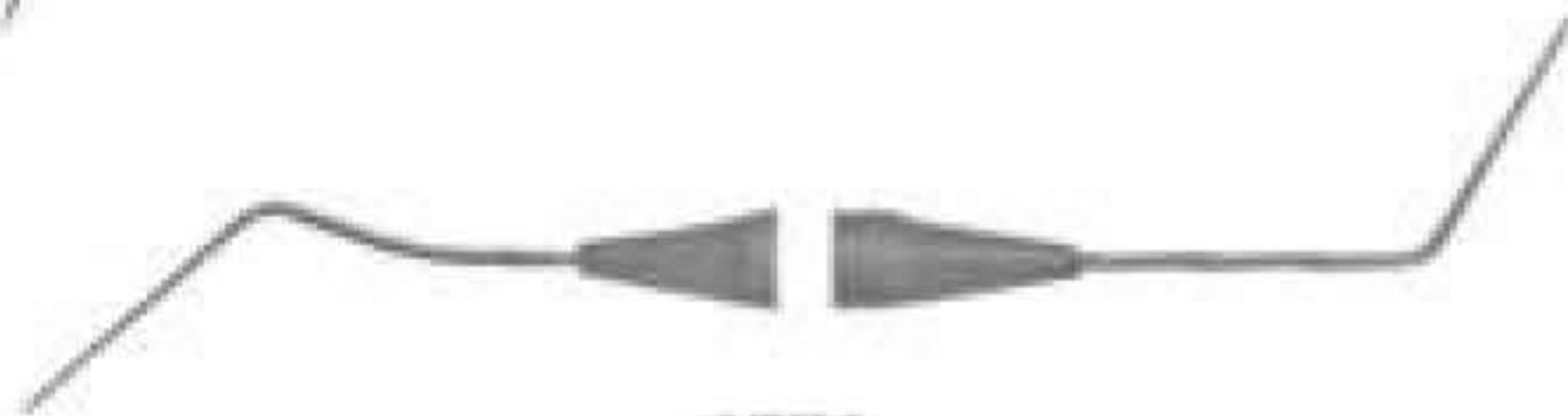

1773
Explorer No.2

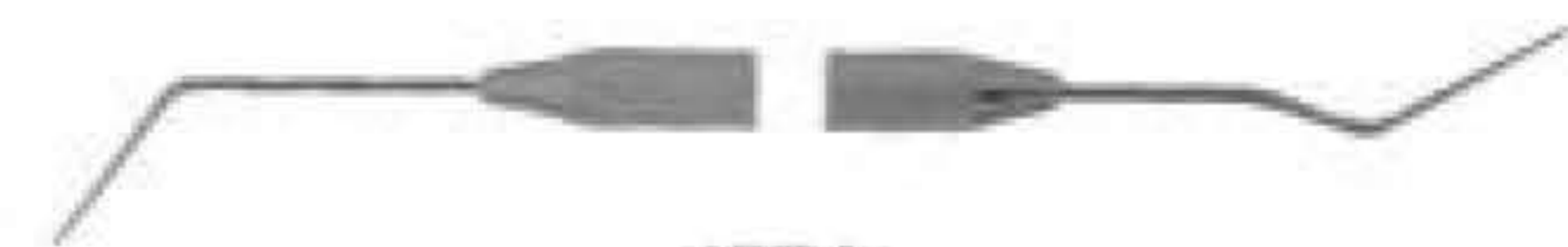

1774
Explorer No.16

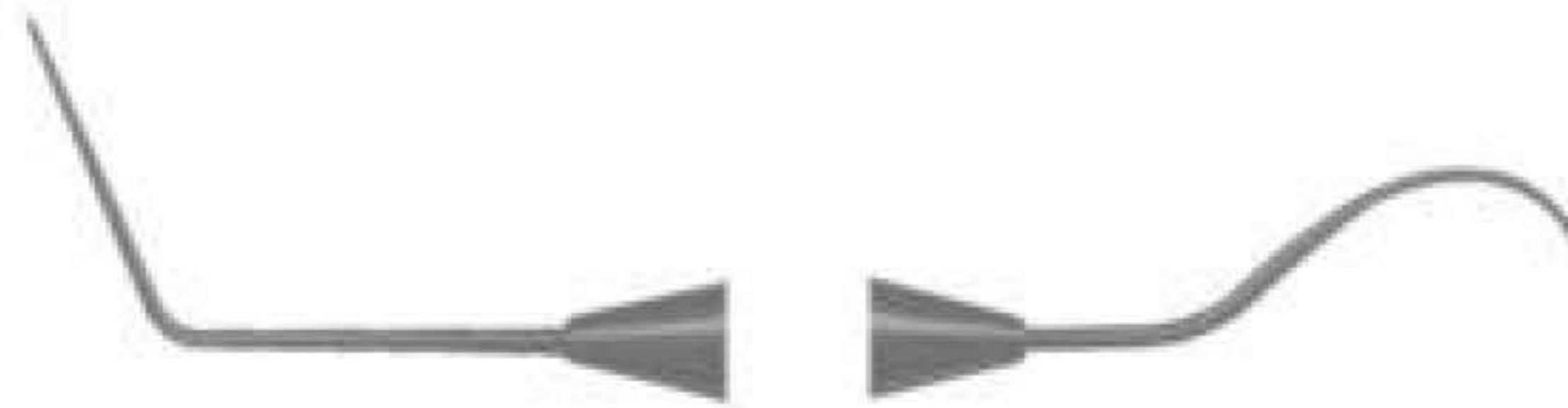

1775
16-23 Explorer



1776
16-17 Explorer



1777
DG16 Explorer



1778
(Heavy DG-16)



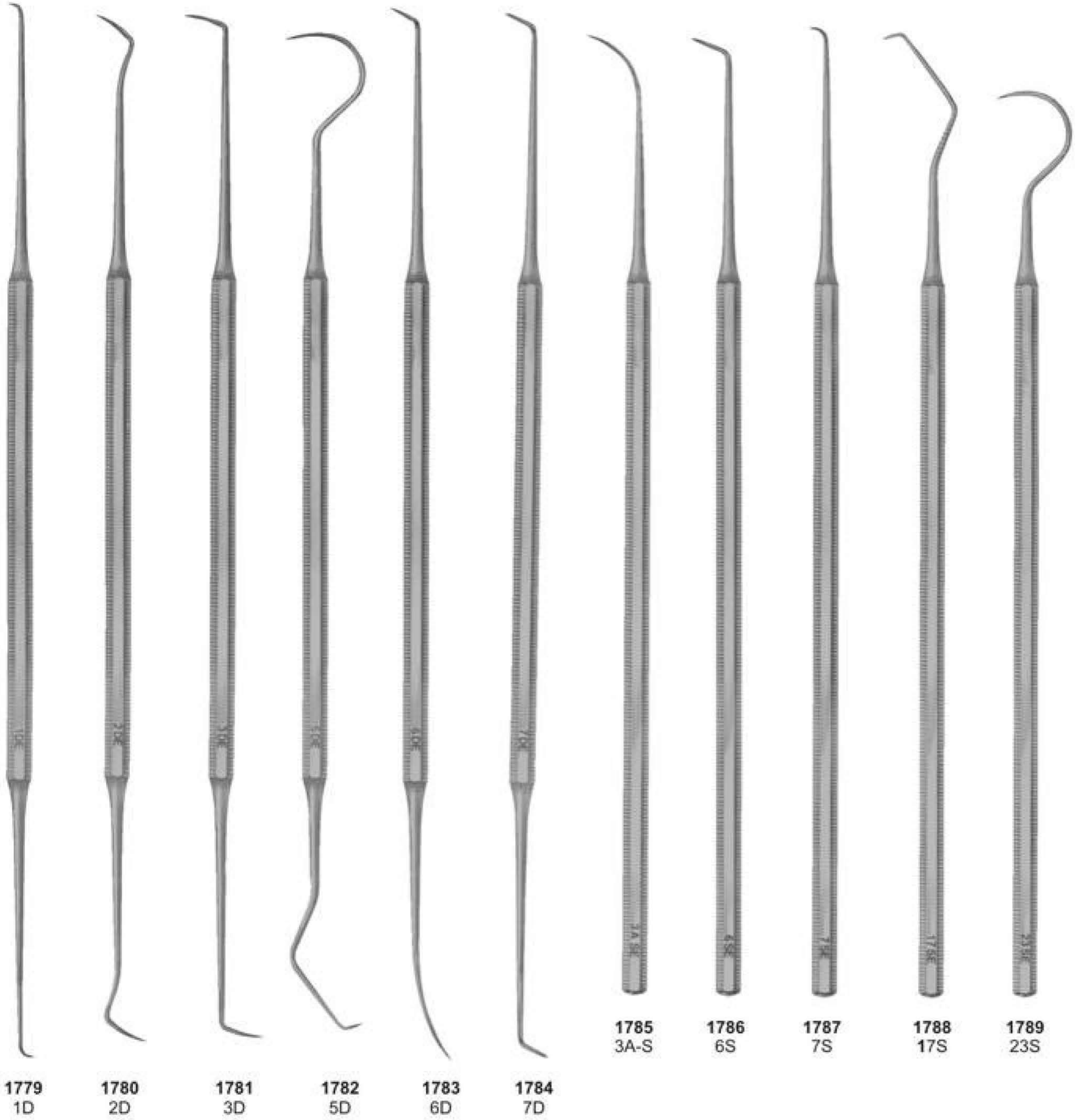

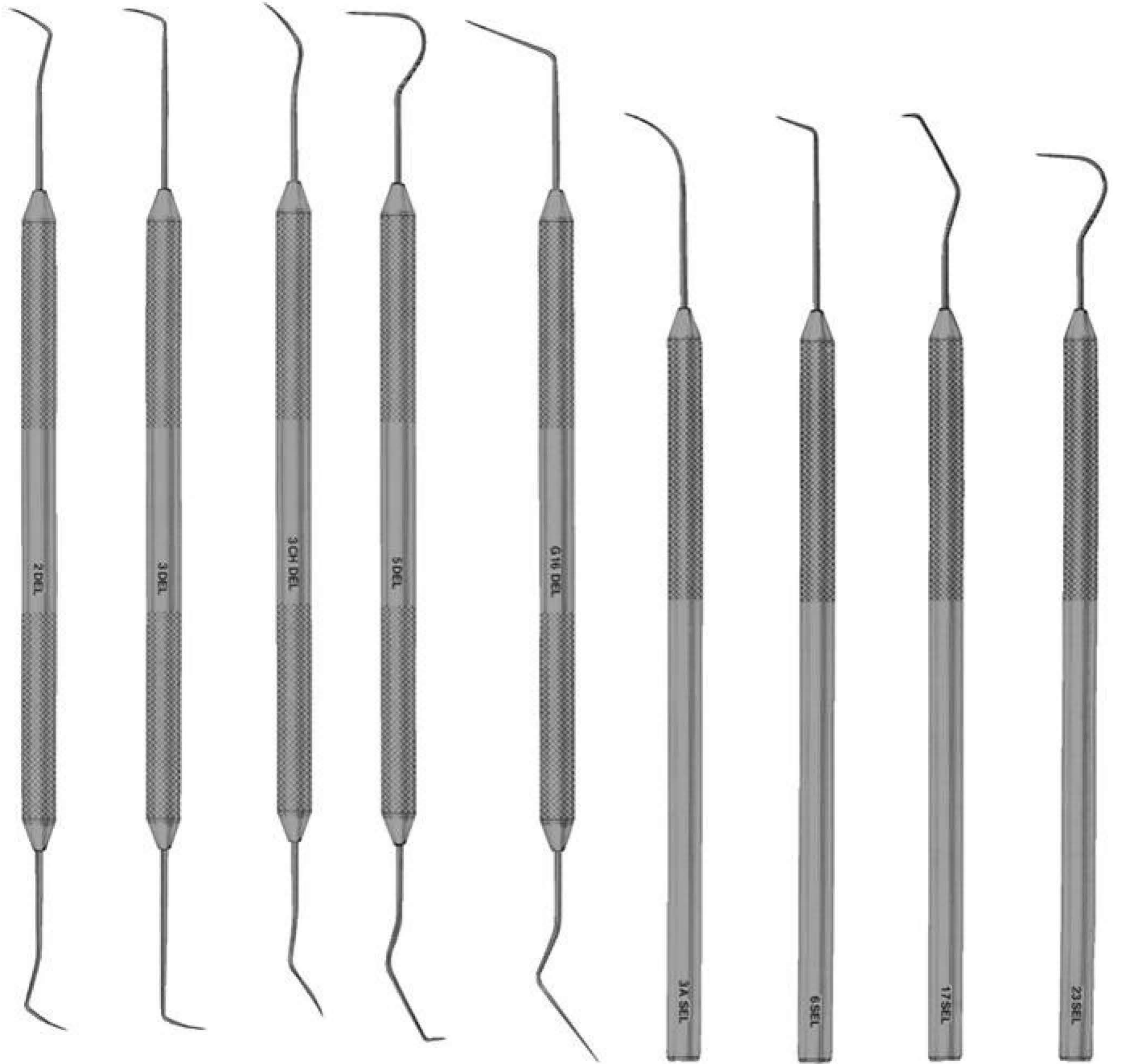

1790
No. 2D-L

1791
No. 3D-L

1792
No. 3CHD-L

1793
No. 5D-L

1794
No. G16D-L

1795
No. 3AS-L

1796
No. 6S-L

1797
No. 17S-L

1798
No. 23S-L





1799
Gf17 Probe/Explorer



1800
PE 1-23 Probe/Explorer

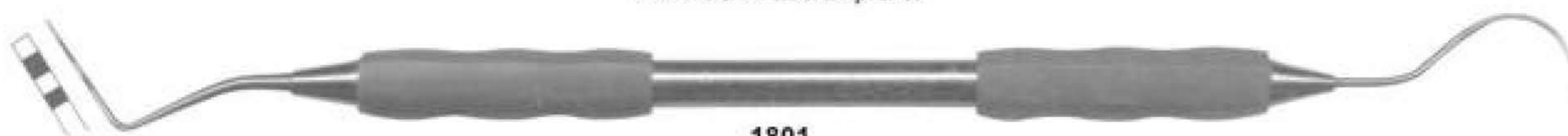

1801
Probe 0 / 23 Explorer (fine)

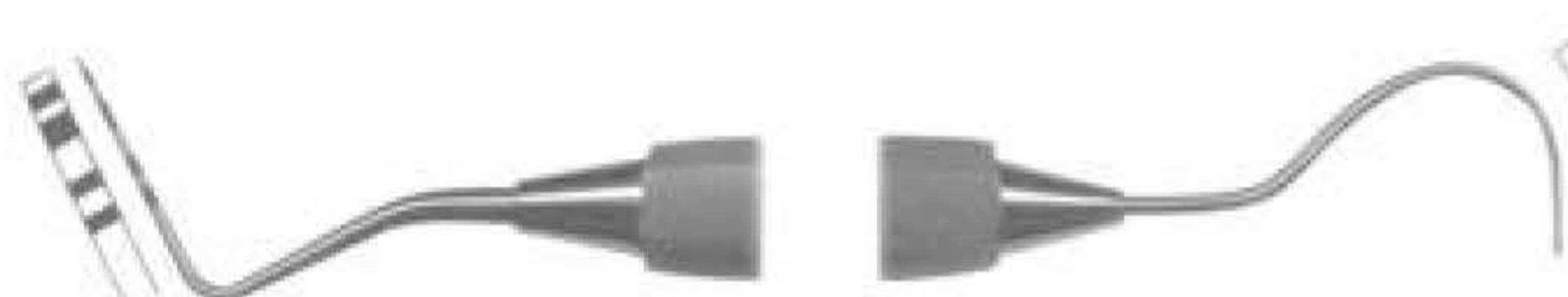

1802
Probe 1 / 23 Explorer

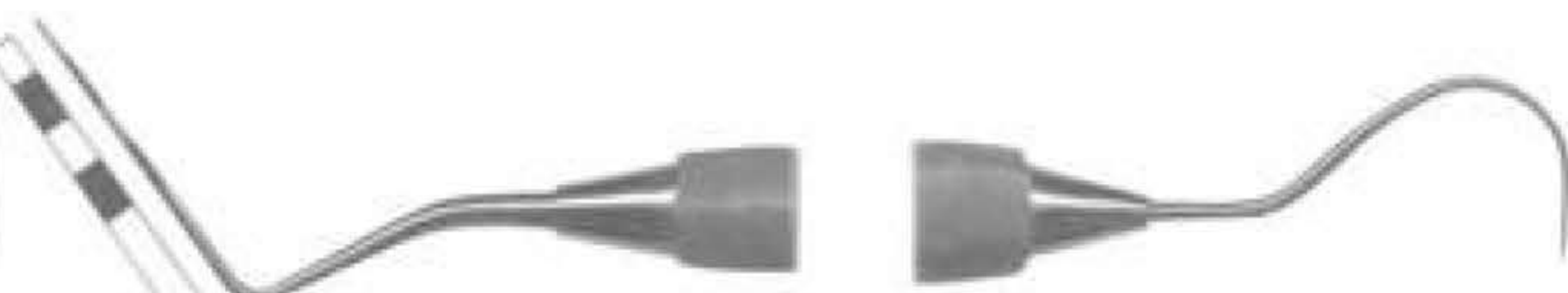

1804
Probe 4 / 23 Explorer



1803
Probe OW / 23 Explorer



1805
Ball Tip Probe WHO / 23 Explorer

PROBES

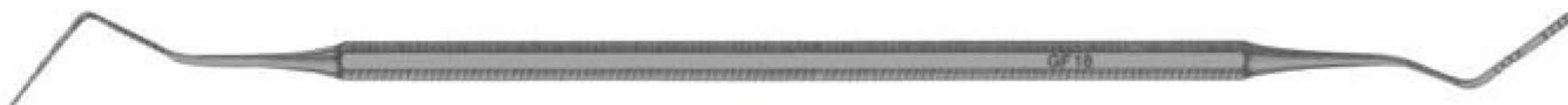

1806
Gf18 Probe



1807
"C" Probe



1808
X2 Probe

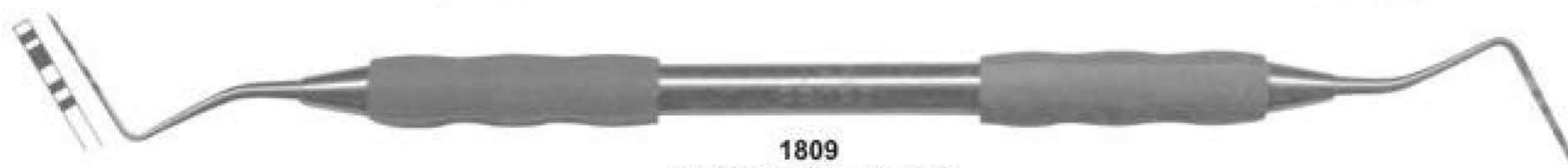

1809
1-2 (Probe 2 end is flat)

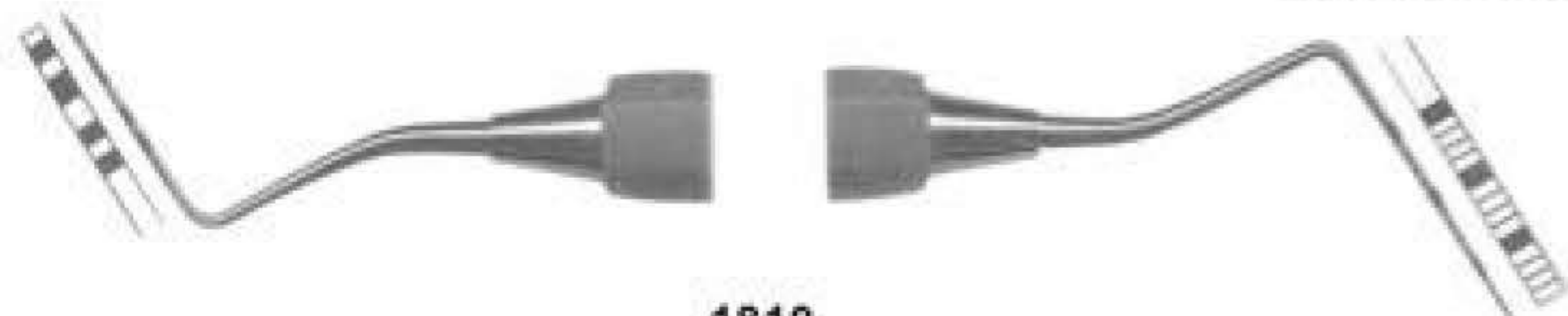

1810
1 UNC 15



1811
4 SE

CORD PACKERS

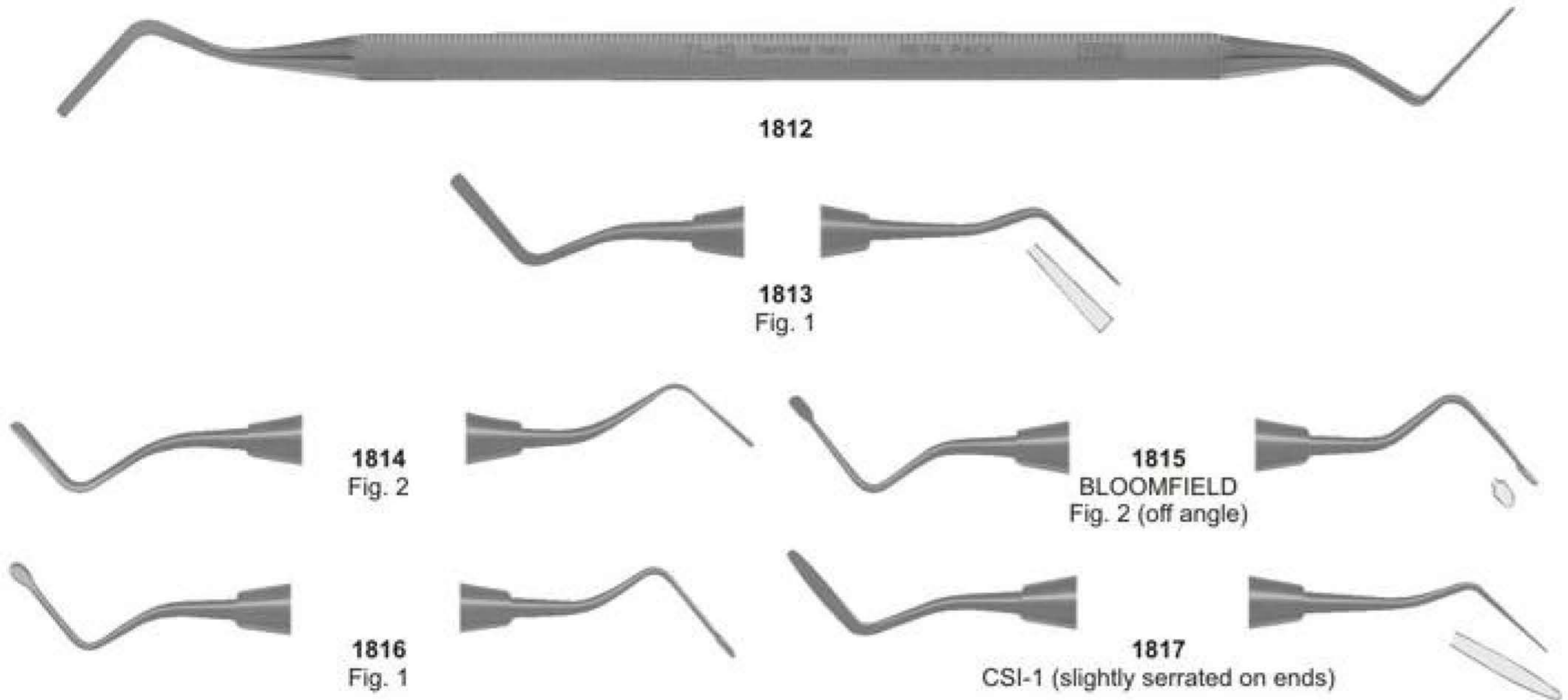

HATCHETS

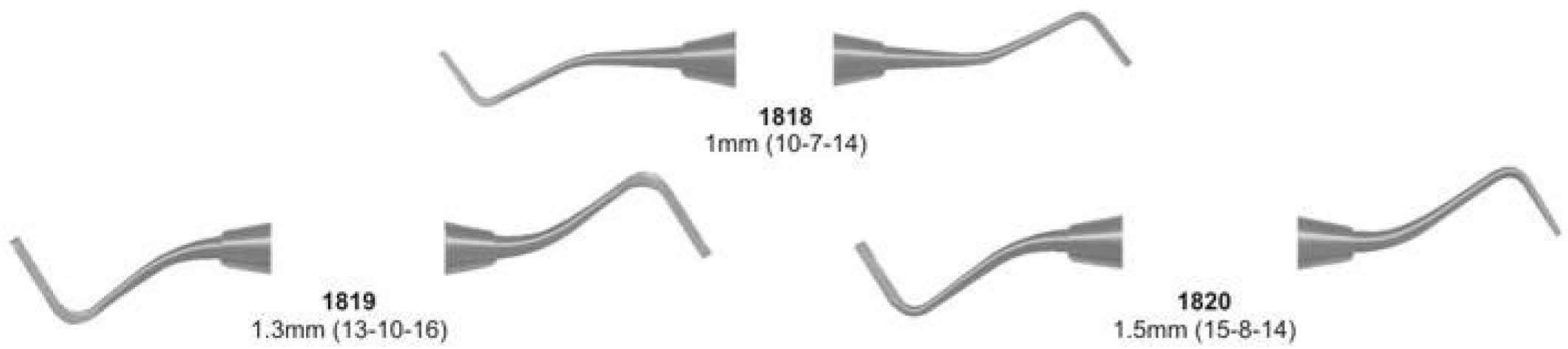

HOES

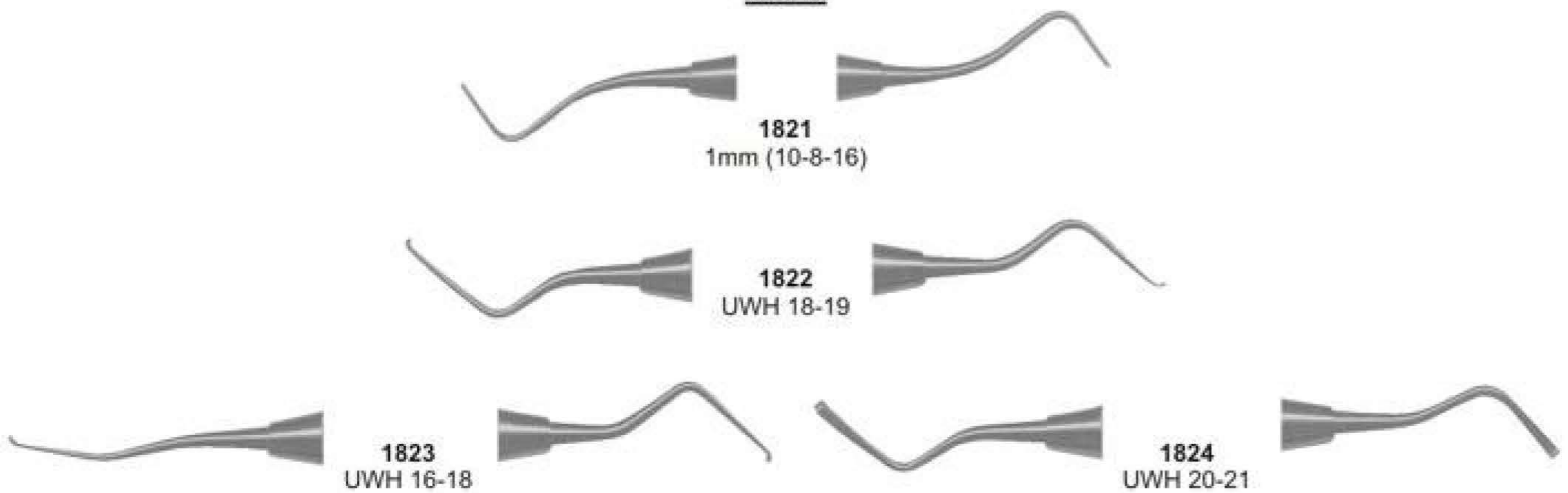



1825
P.K.Thomas 1



1826
P.K.Thomas 2

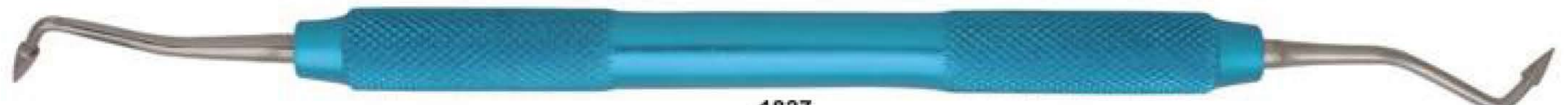

1827
P.K.Thomas 3



1828
P.K.Thomas 4

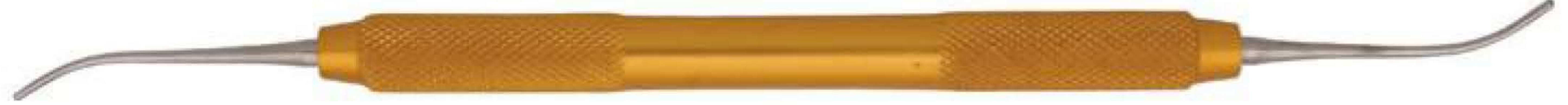

1829
P.K.Thomas 5



7001
Gracey Currettes Set of 7 Pcs, Silicon Handle - Reuseable

