

Amputation and Resection Knives

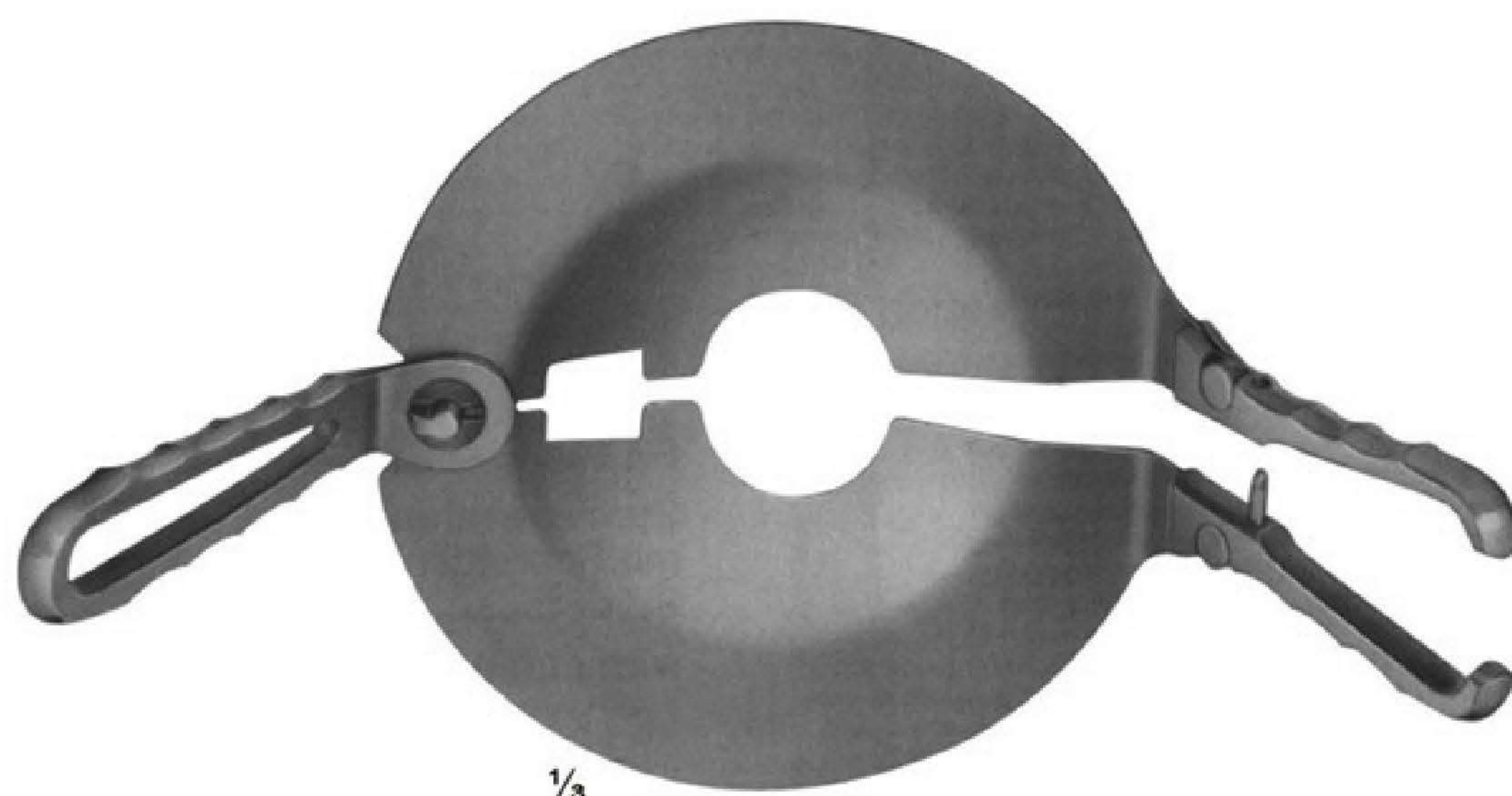

Amputation Retractors



06-8006
PERCY
removeable handles

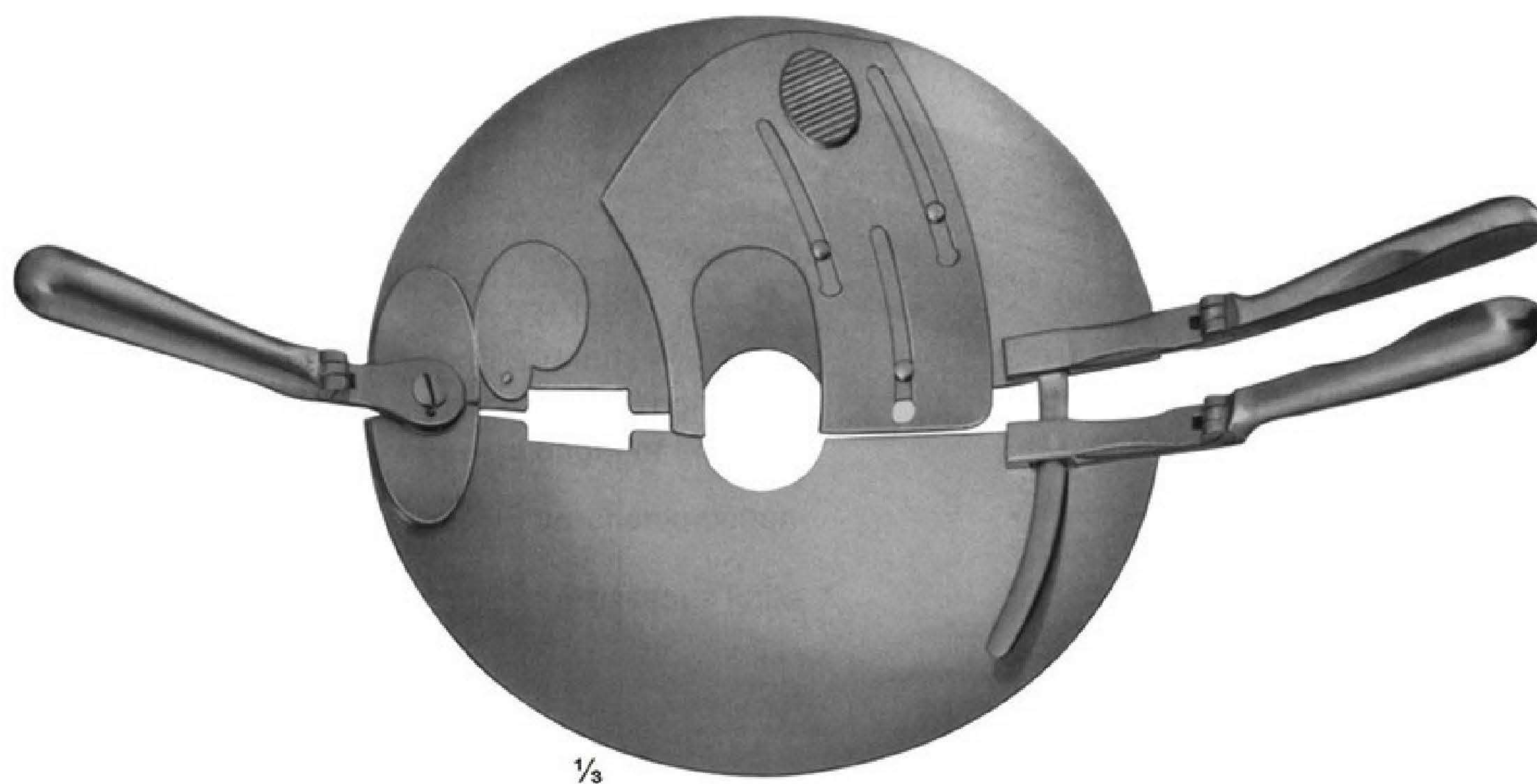

06-8007
PERCY
reversible handles

Amputation Saws



06-8008
CHARRIERE
Length of blade
215 mm
complete with one saw
blade each(**06-8009** and **06-8010**)
350 mm

Spare saw blades, carbon steel
06-8009 12 mm
06-8010 20 mm

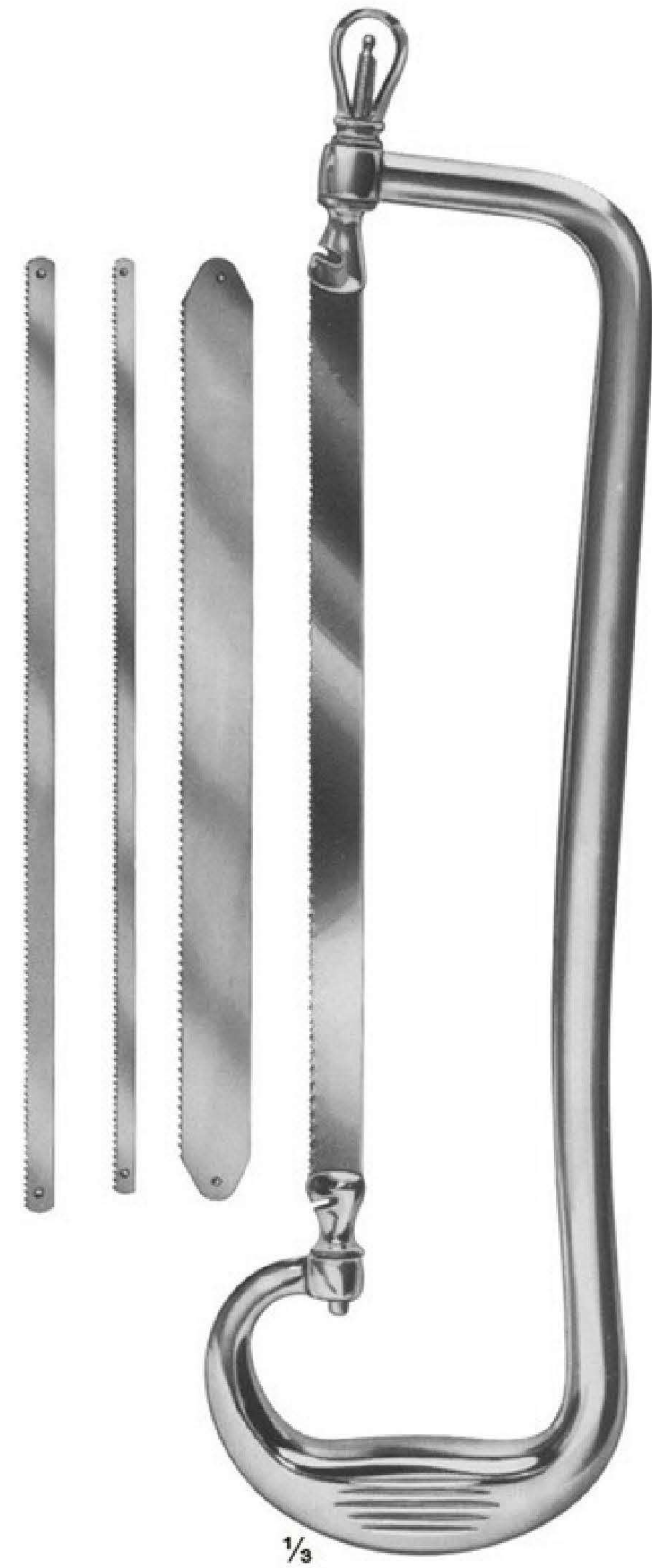

06-8011
RUST
Length of blade
235 mm
complete with one saw
blade each(**06-8013**, **06-8014**
and 2 saw blades **06-8015**)
390 mm
06-8012 Bow only

Spare saw blades, carbon steel
06-8013 6 mm
06-8014 8 mm
06-8015 12 mm
06-8016 20 mm

Amputation Saws

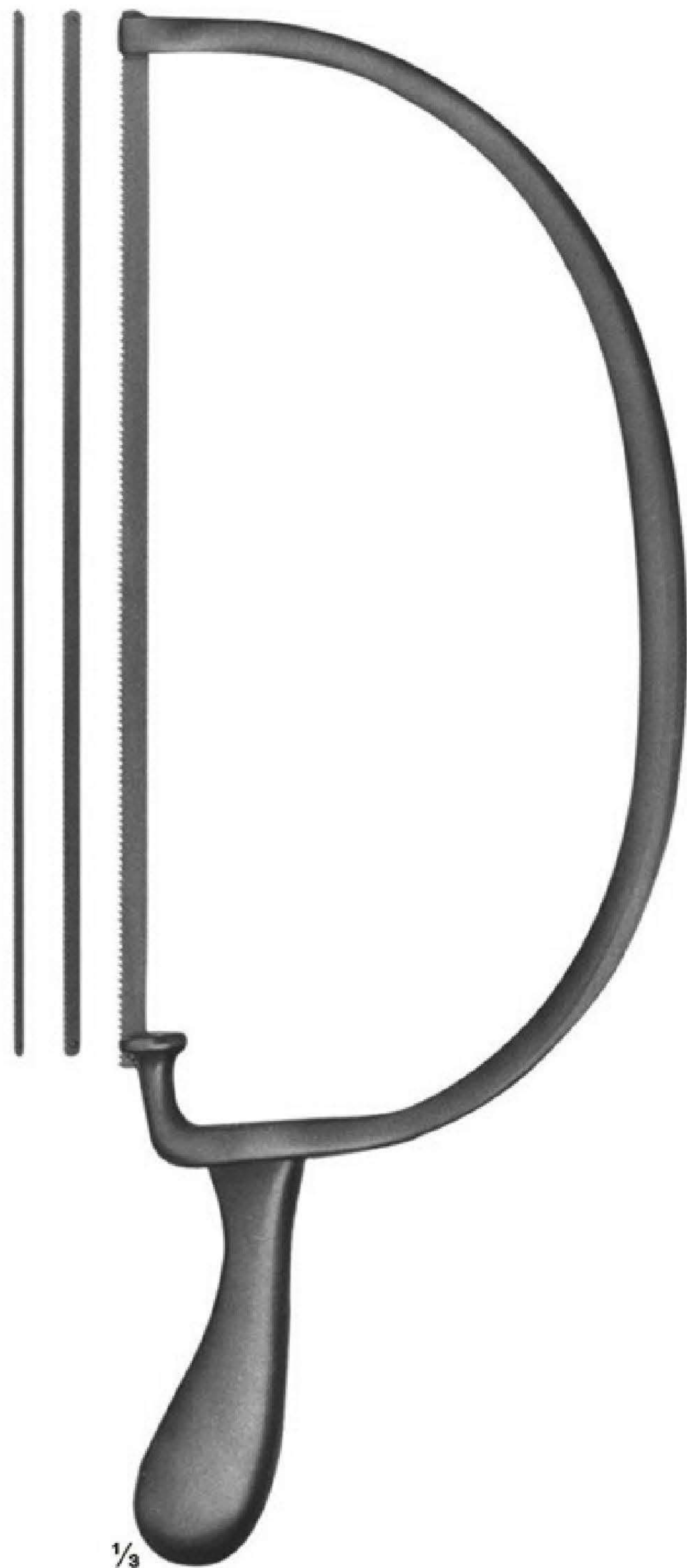

1/3
06-8017
 BIER
 Length of blade
 270 mm
 complete with one saw
 blade each (**06-8018, 06-8019** and **06-8020**)
 420 mm

Spare saw blades, carbon steel
06-8018 4 mm
06-8019 6 mm
06-8020 8 mm

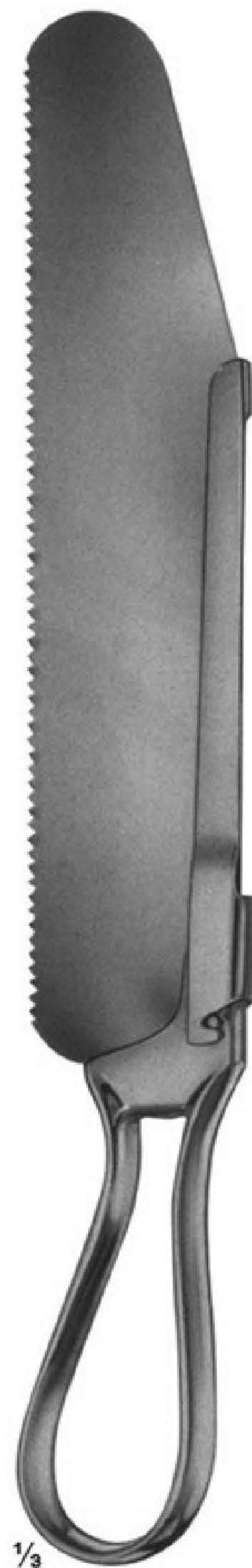

1/3
06-8021
 CHARRIERE
 Length of blade
 180 mm
 Spare saw blade,
 carbon steel (**06-8022**)
 270 mm

06-8023
 CHARRIERE
 Length of blade
 240 mm
 Spare saw blade,
 carbon steel (**06-8024**)
 340 mm



1/3
06-8025
 SATTERLEE
 Length of blade
 200 mm
 Spare saw blade,
 carbon steel (**06-8026**)
 200 mm



1/3
06-8027
 LANGENBECK
 Length of blade
 115 mm
 Metacarpal saw
 235 mm

Wire Saws And Conductor



06-8028 - 06-8031
 OLIVECRONA
 06-8028 300 mm
 06-8029 400 mm
 06-8030 500 mm
 06-8031 700 mm

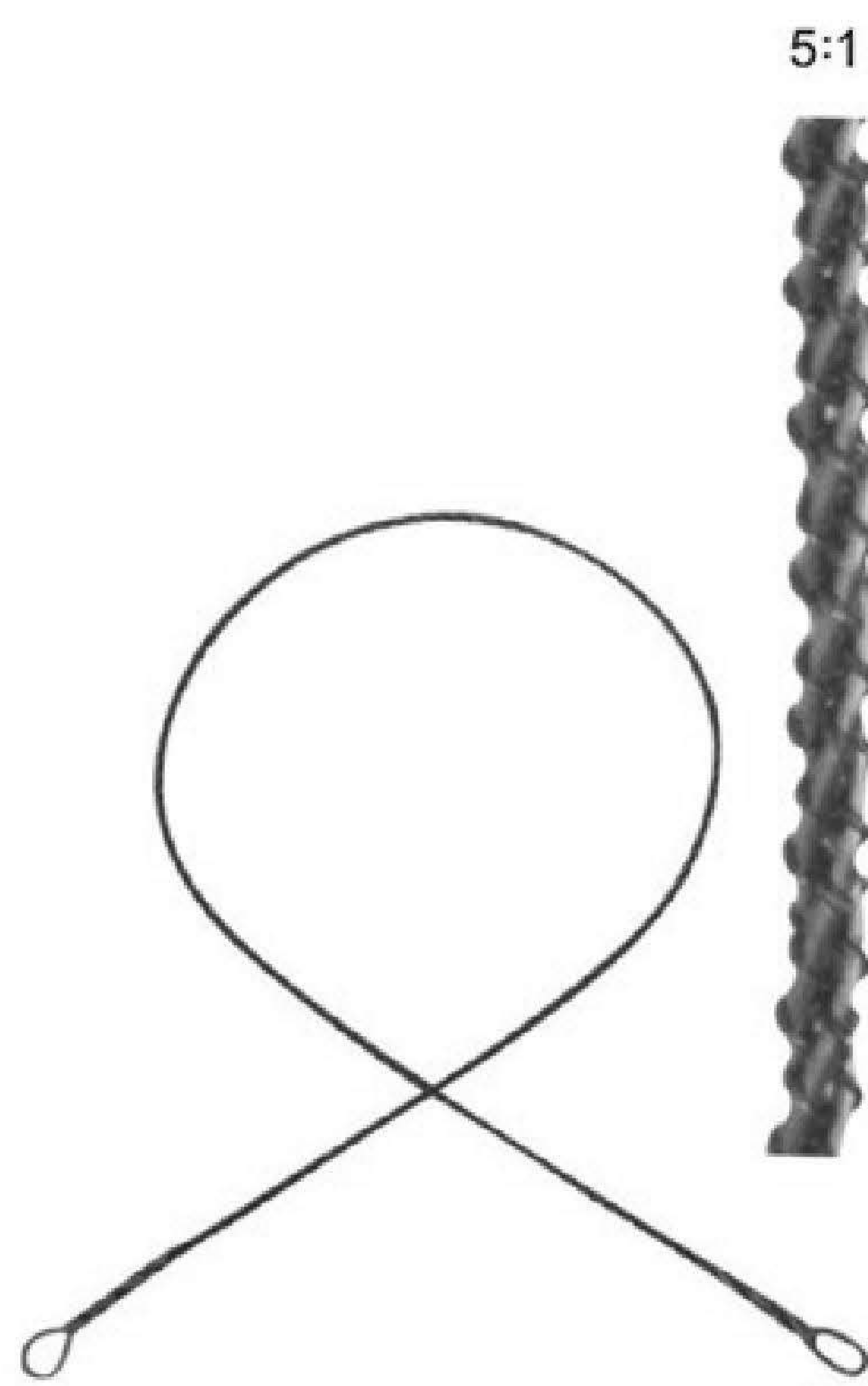

06-8032 - 06-8035
 GIGLI
 06-8032 300 mm
 06-8033 400 mm
 06-8034 500 mm
 fine, 6 wires twisted
 06-8035 500mm
 coarse, 4 wires twisted



06-8036
 GIGLI
 Handle



06-8037
 LEBSCHE
 Conductor for
 wire saws, malleable
 250 mm

Elevators and Bone Levers

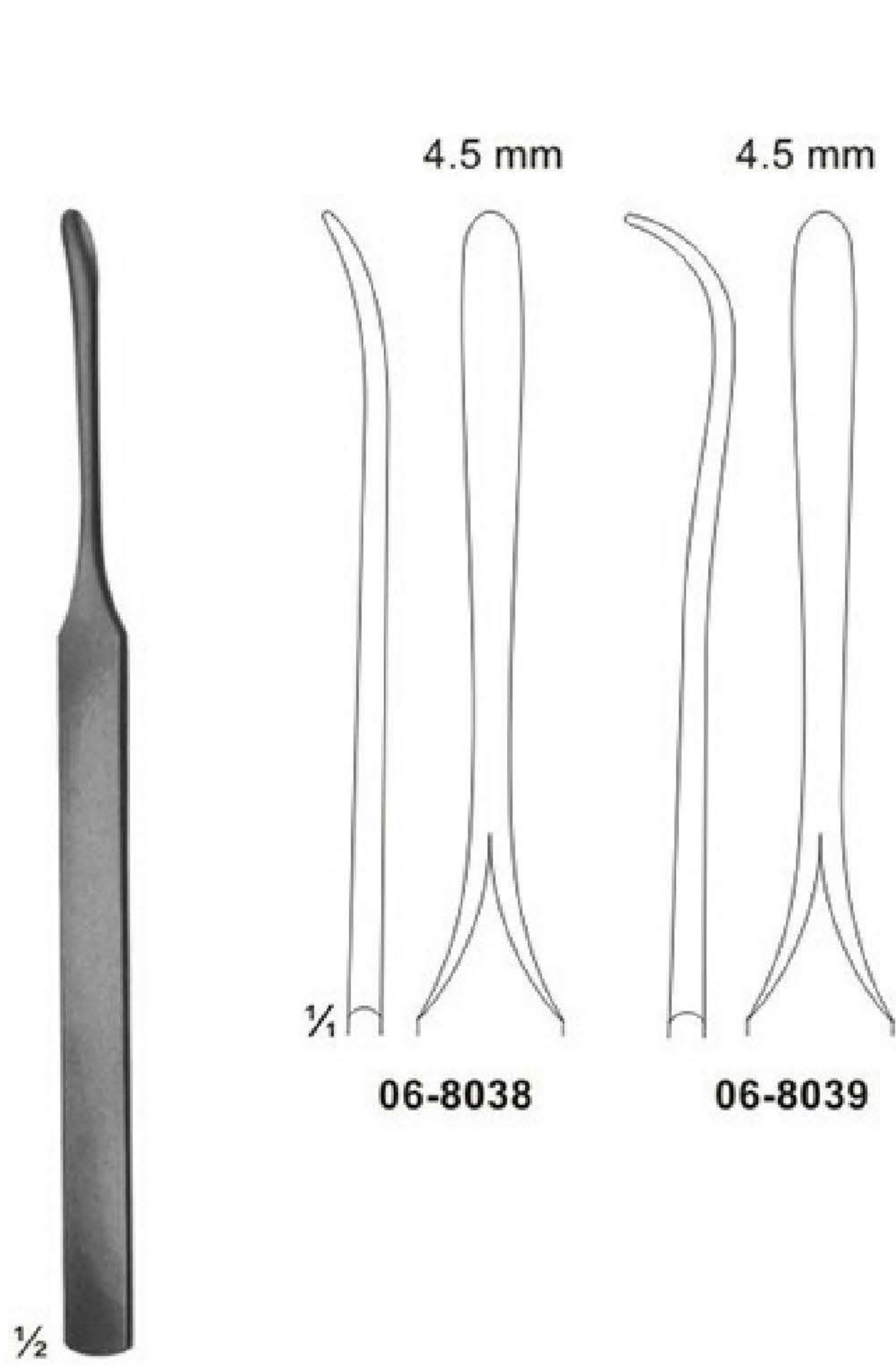

06-8038 - 06-8039
 KOENIG
 155 mm

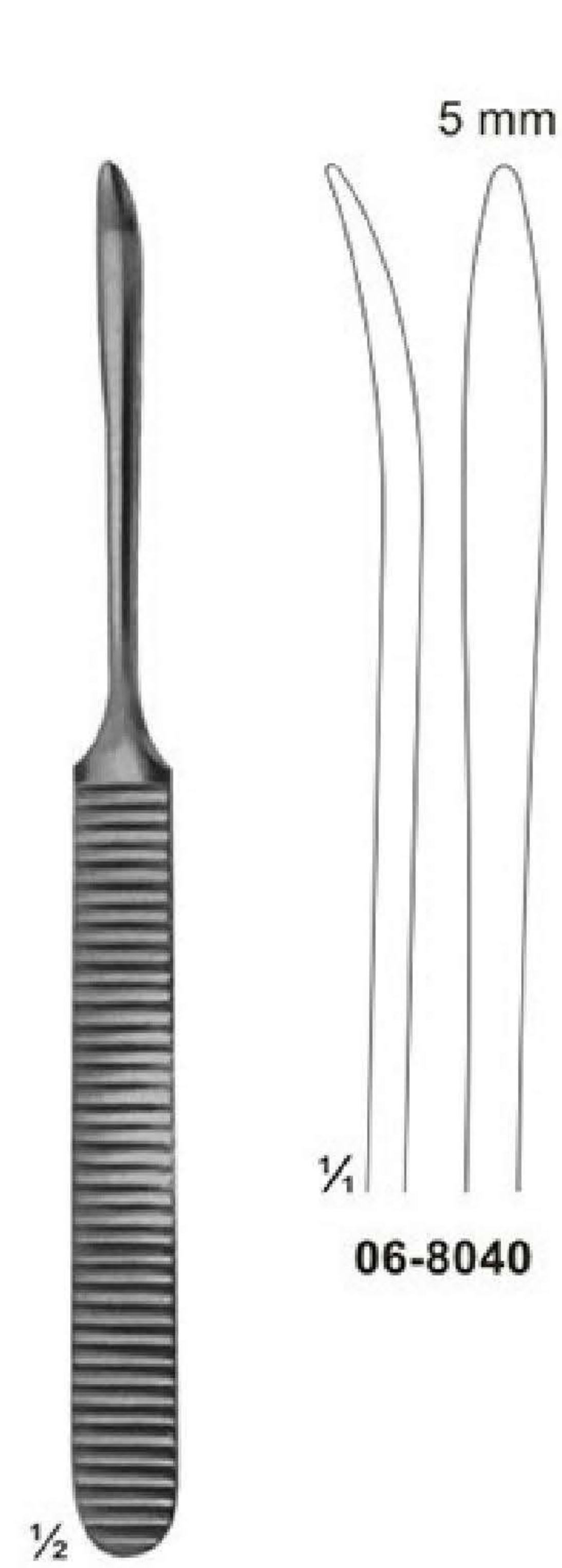

06-8040
 WILLIGER
 165 mm

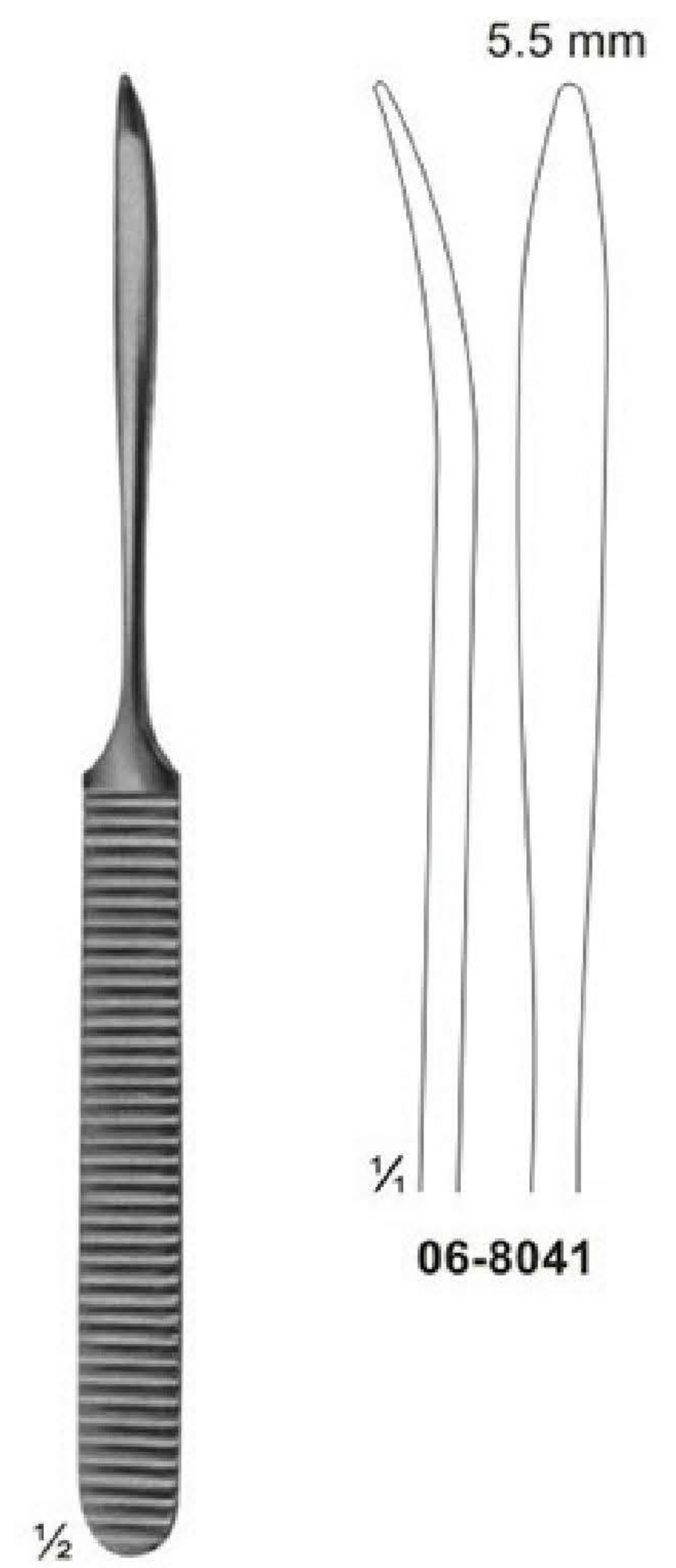

06-8041
 WILLIGER
 170 mm

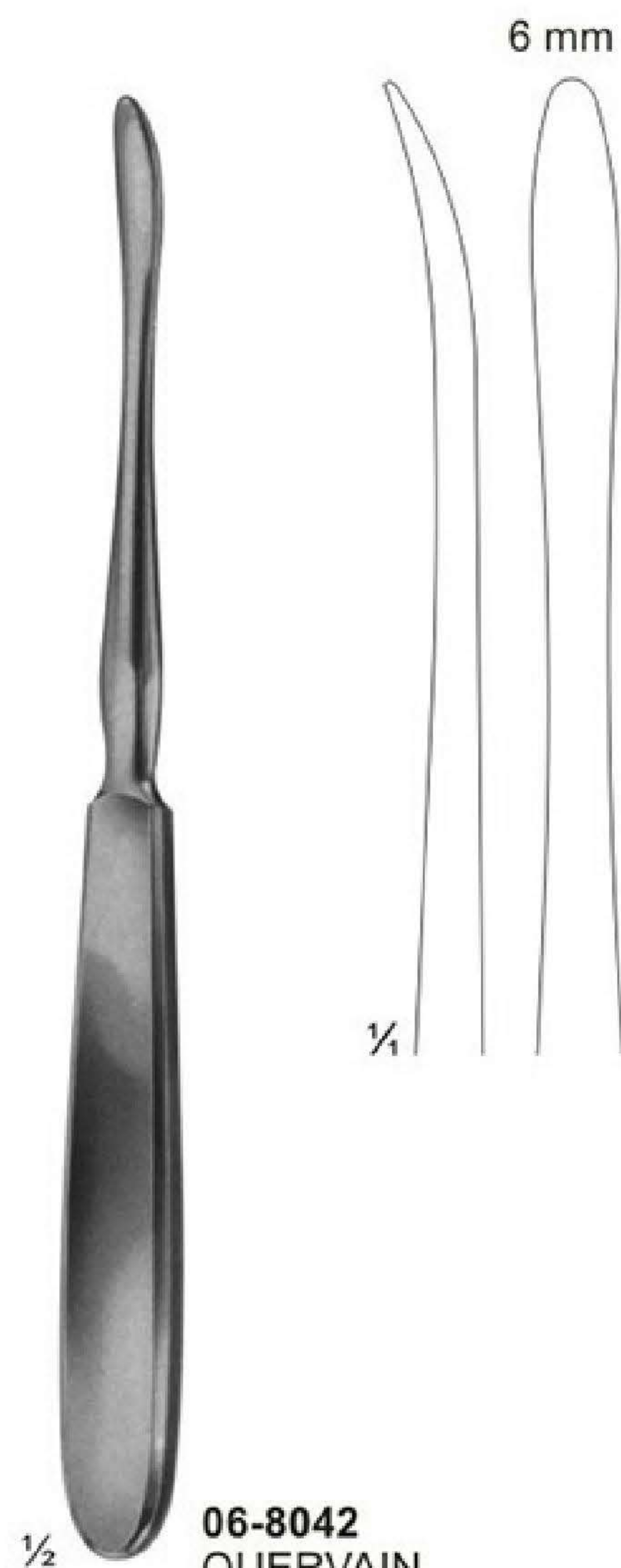

06-8042
 QUERVAIN
 195 mm

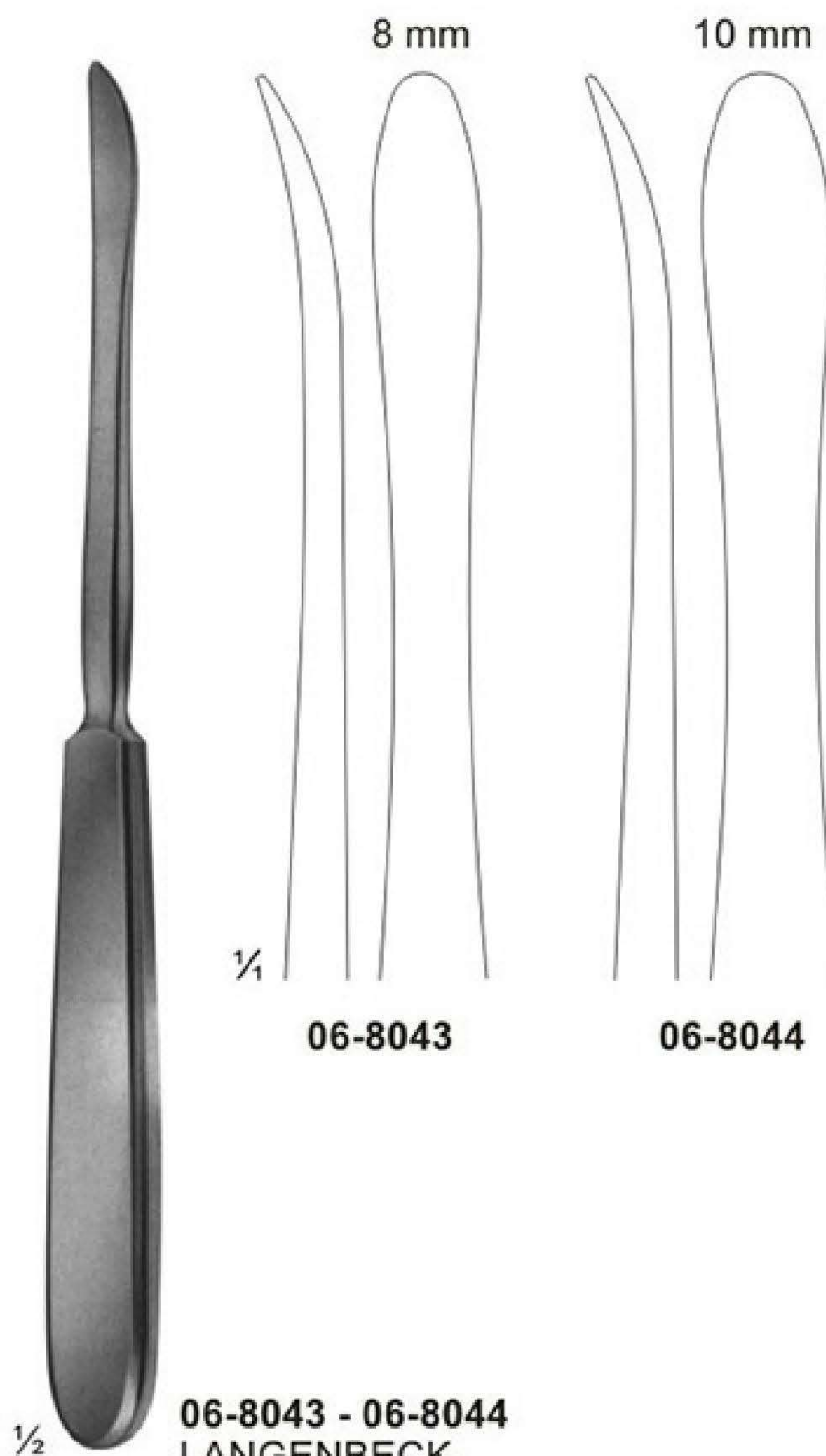

06-8043 - 06-8044
 LANGENBECK
 195 mm

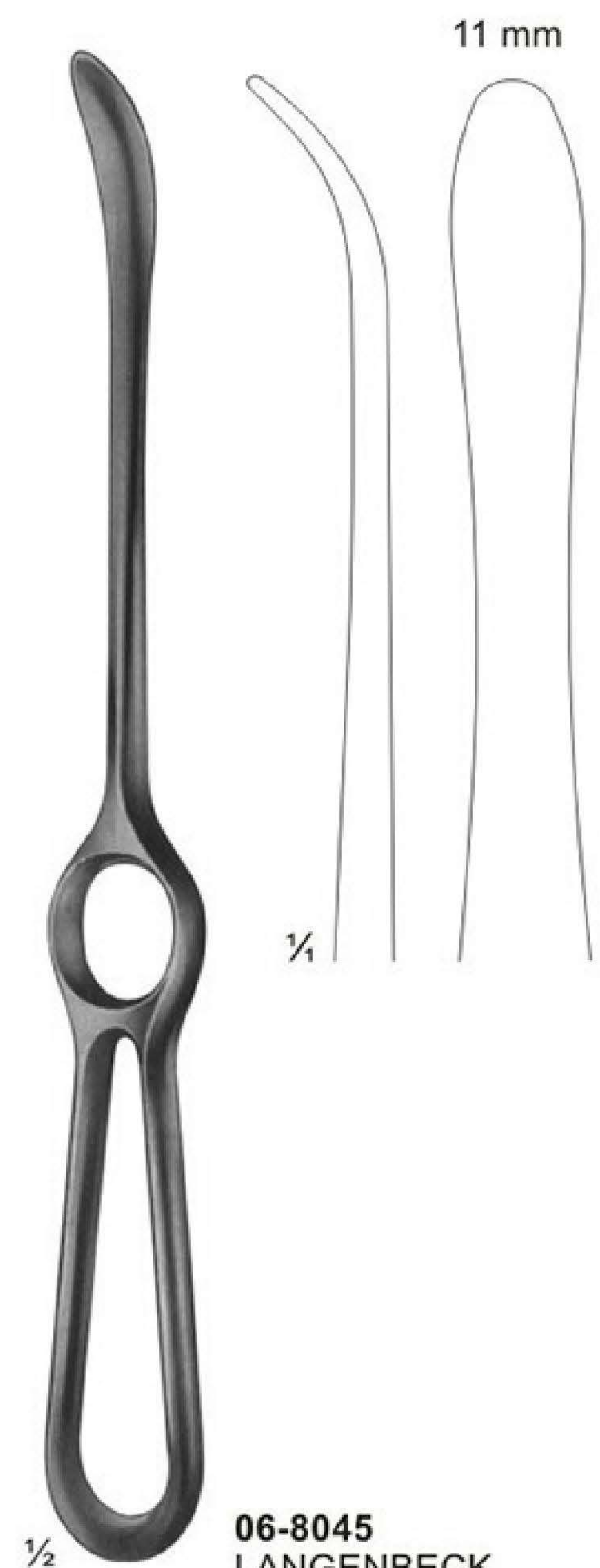

06-8045
 LANGENBECK
 230mm

Bone Levers

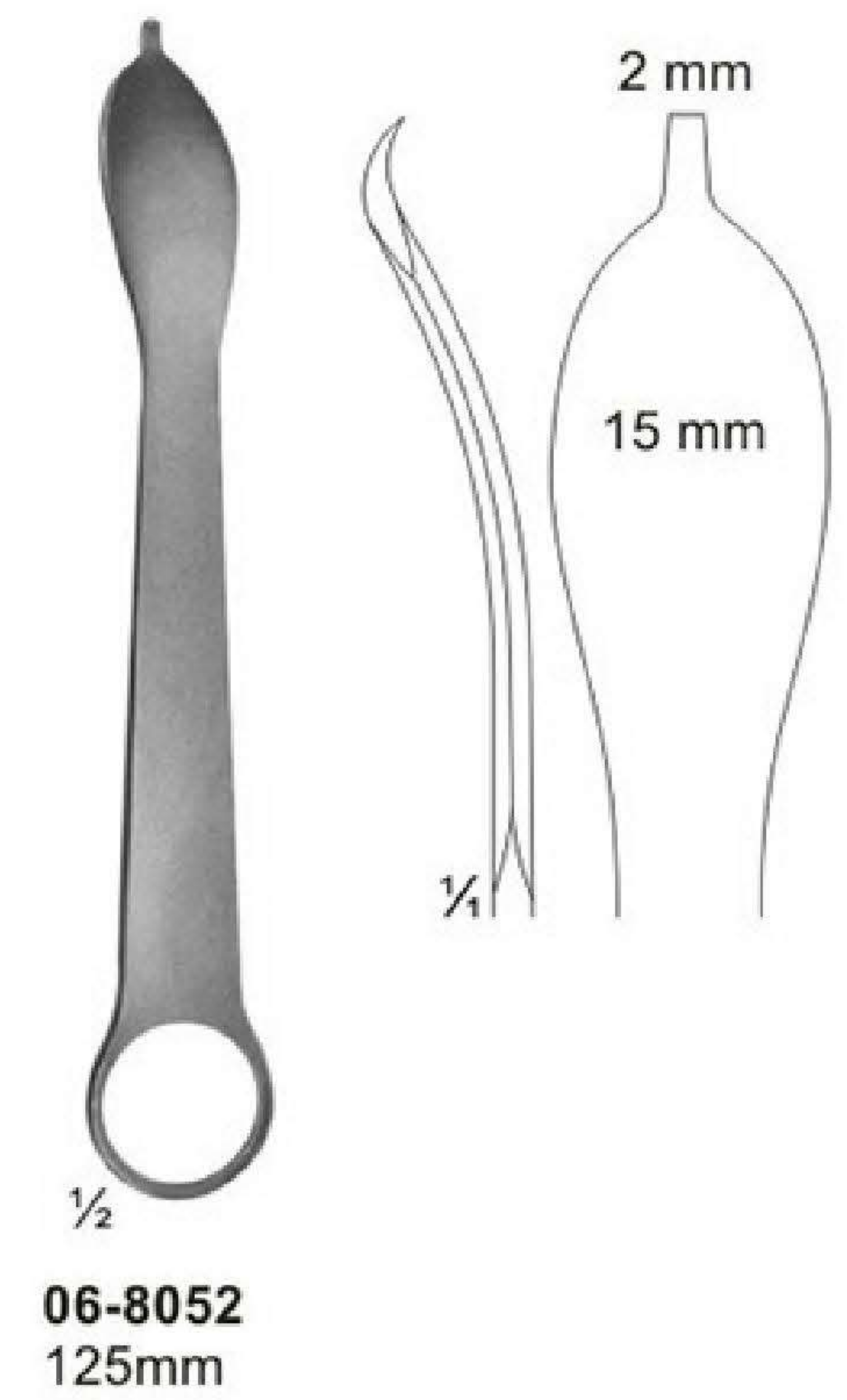
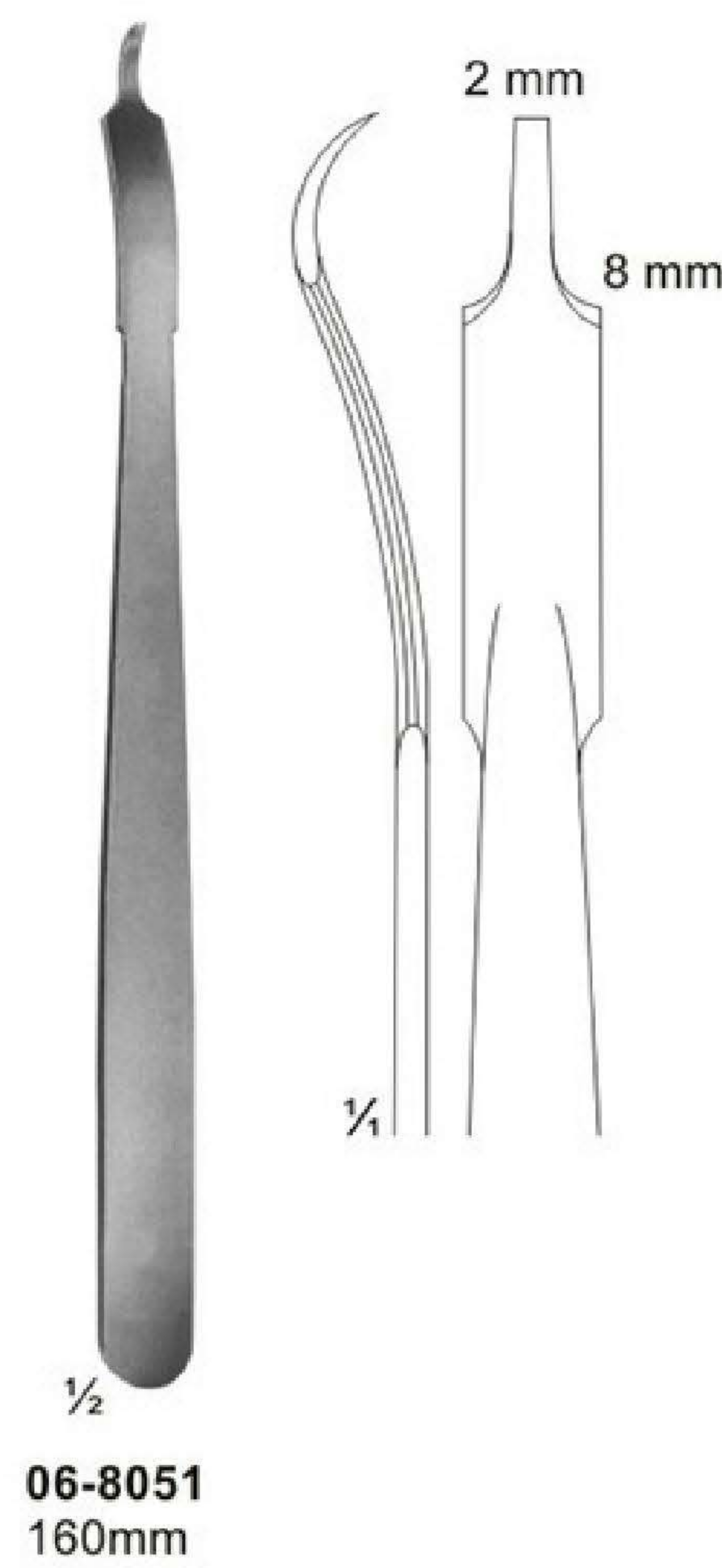
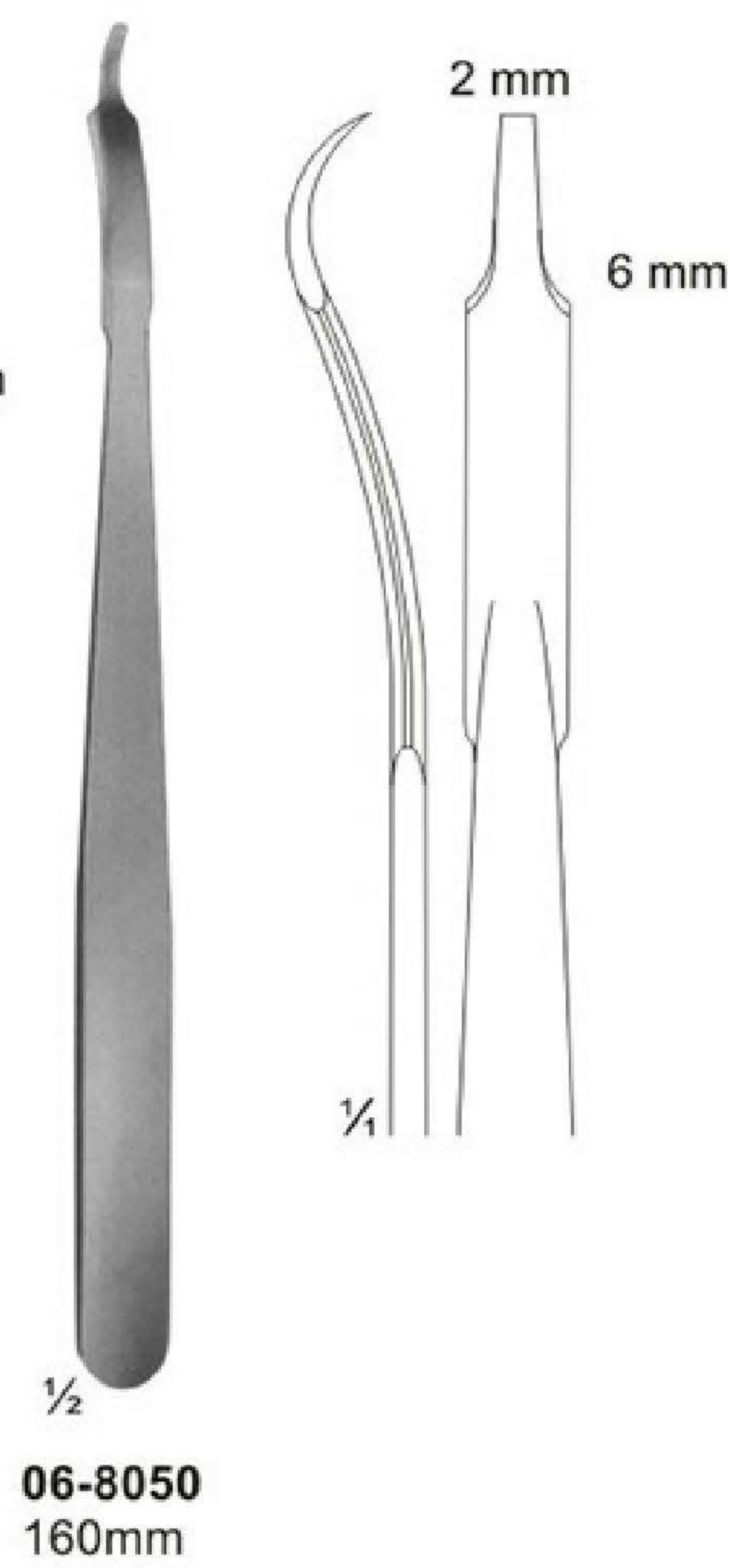
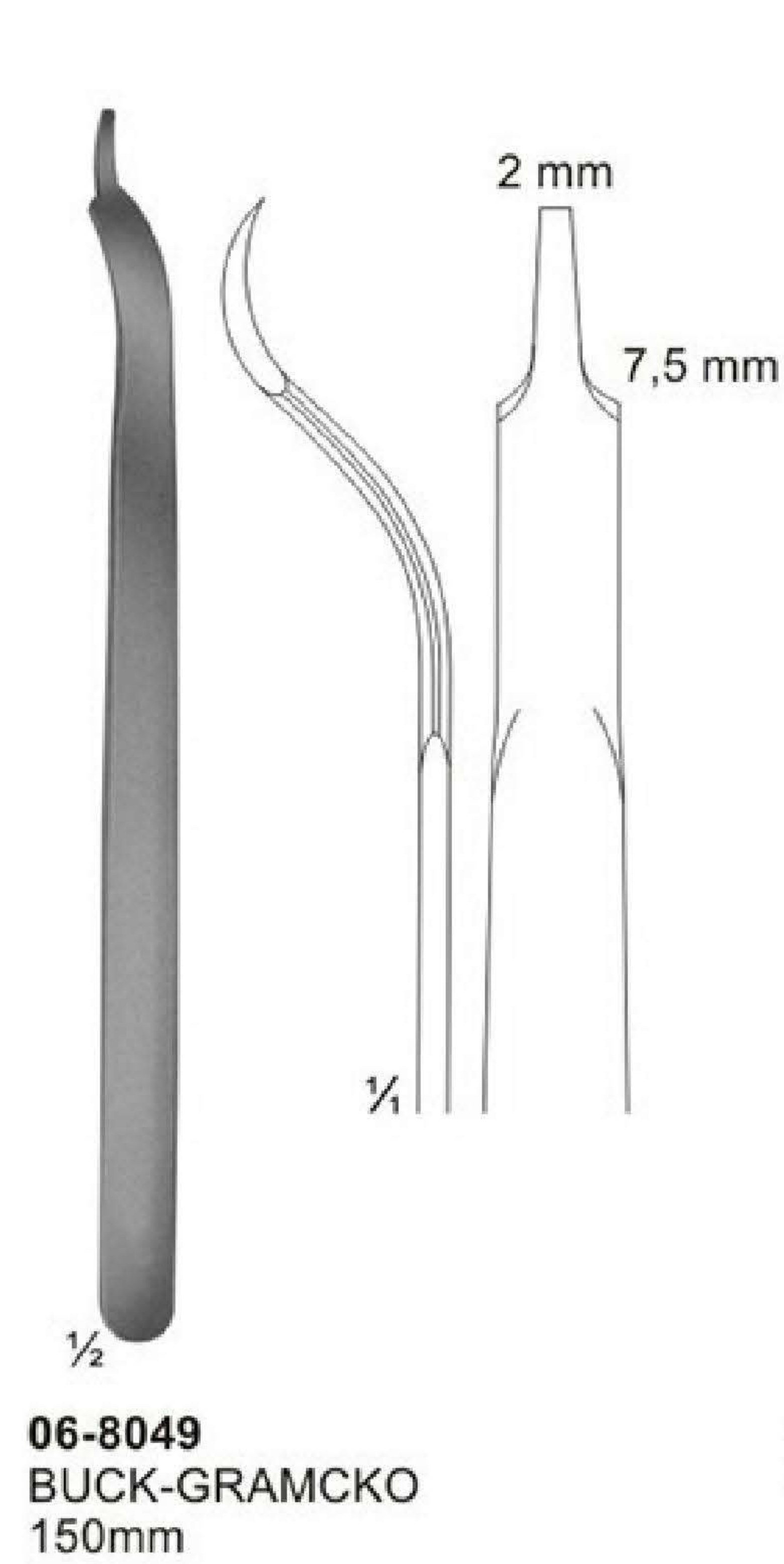
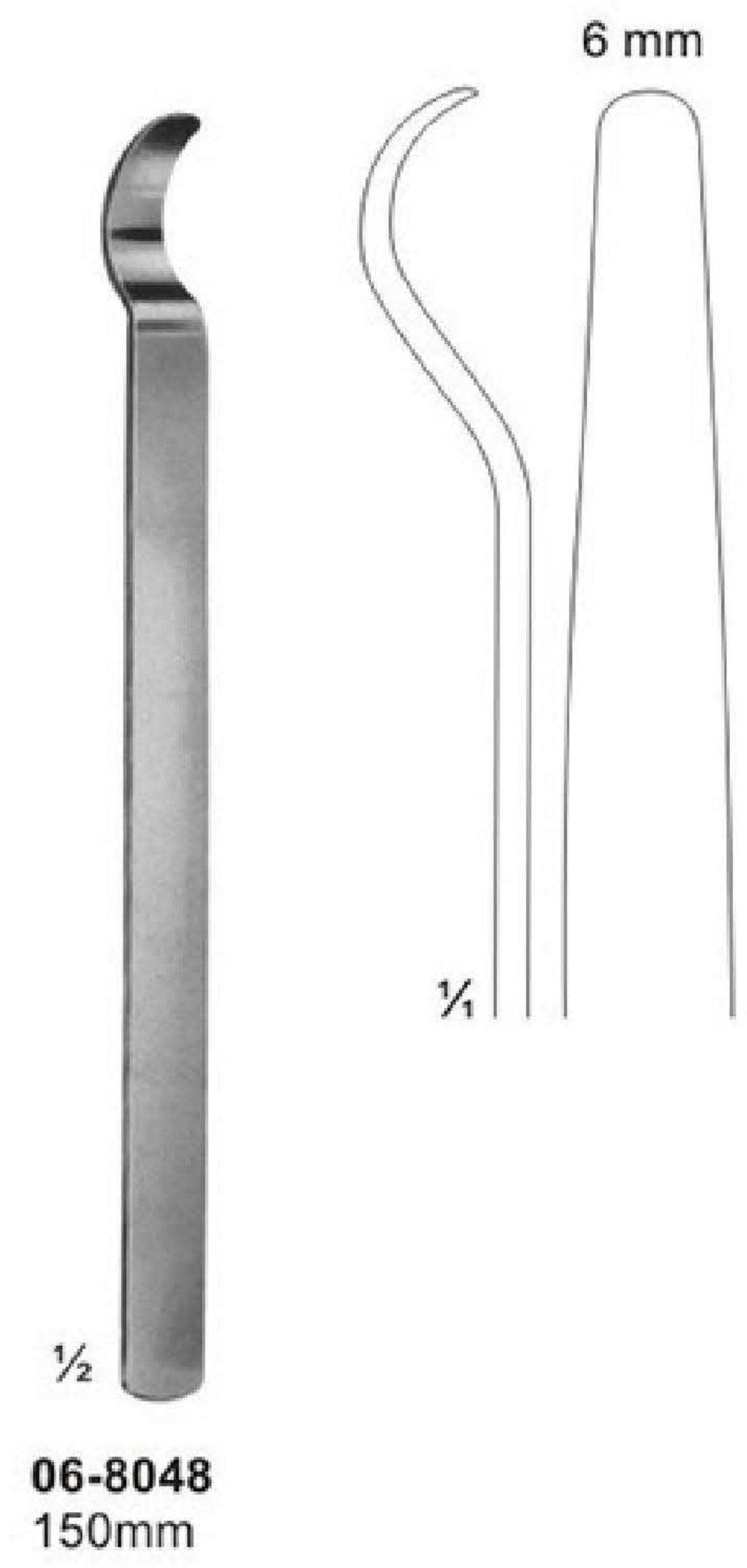
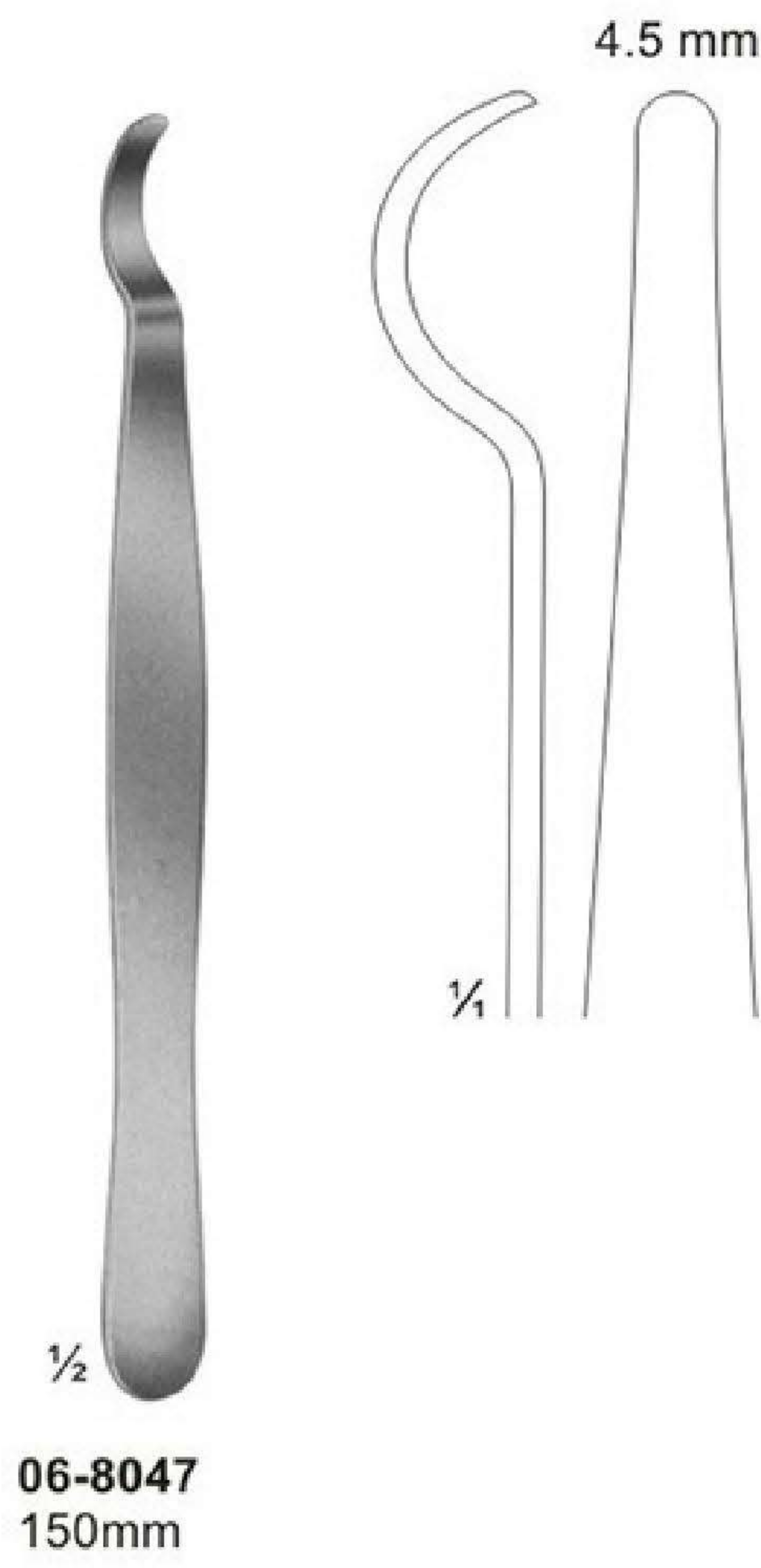
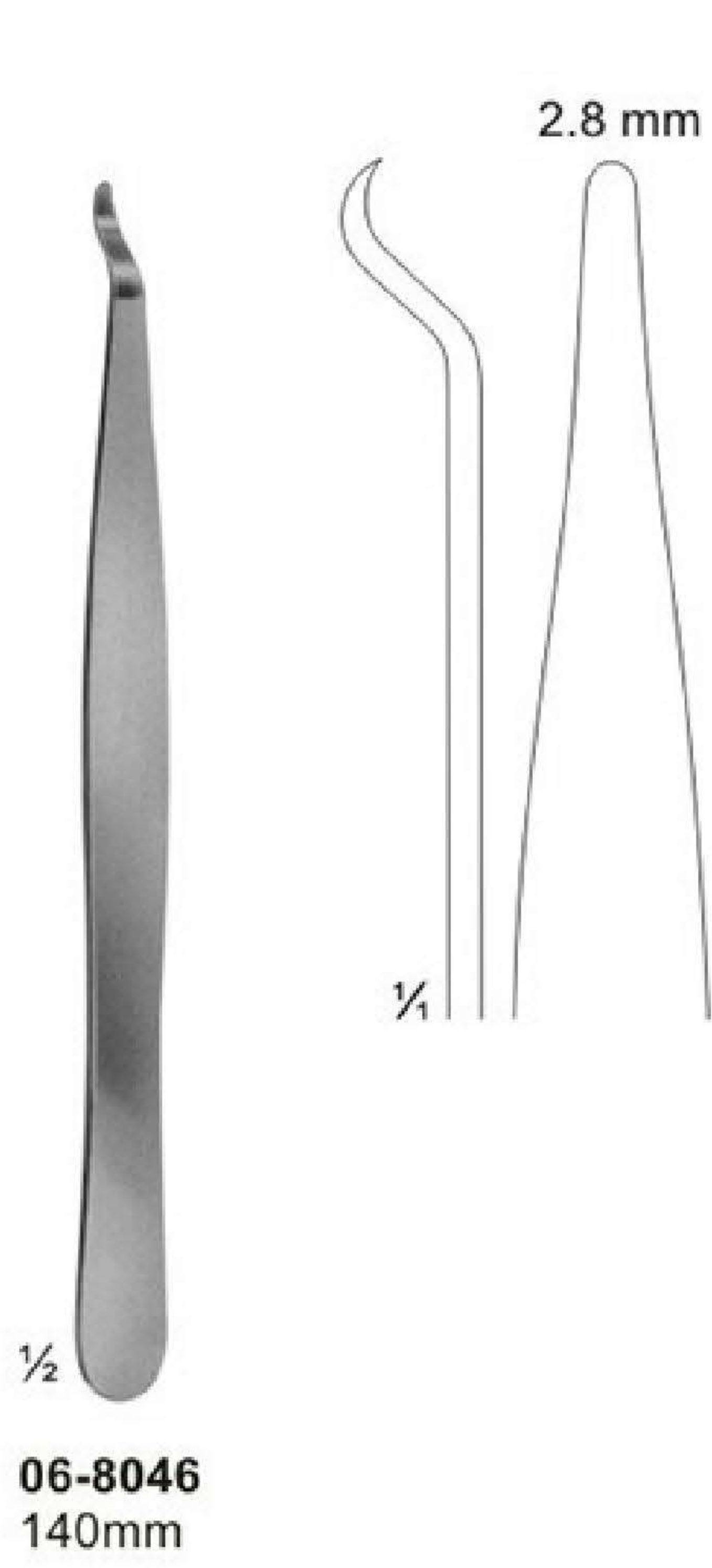

Bone Levers

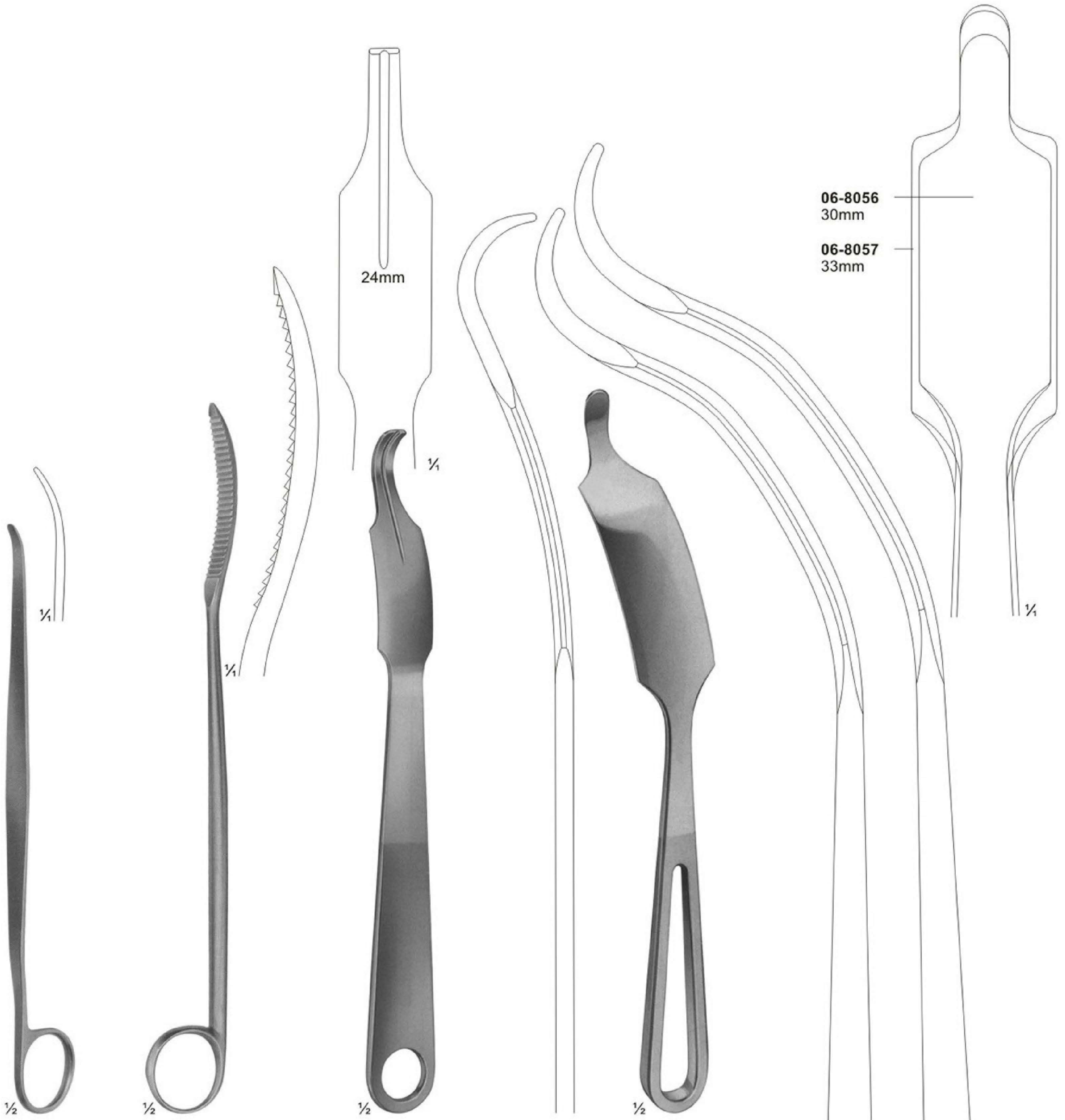

06-8053
 LANE TRETOWAN
 215mm

06-8054
 LANE
 255mm

06-8055
 LANGE-HOHMANN
 250mm

06-8056 - 06-8057
 LANGE-HOHMANN
 modif
06-8056 265mm
06-8057 280mm

Bone Levers



06-8058
 WAGNER
 220 mm

06-8059
 220 mm

06-8060
 240 mm

06-8061
 240 mm

Bone Levers

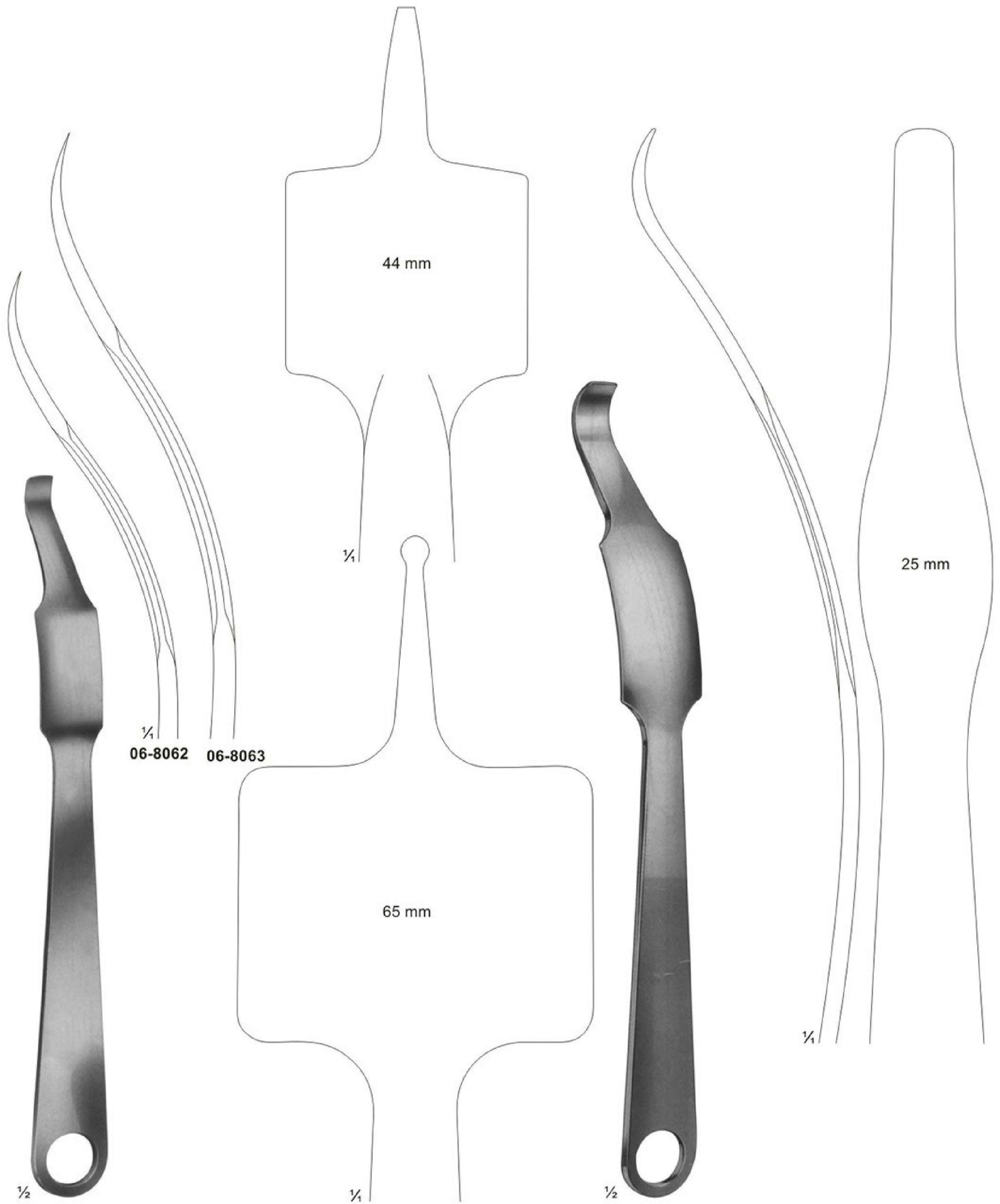

06-8062 - 06-8063
 VERBRUGGE-MULLER
 06-8062 240 mm
 06-8063 255 mm

06-8064
 260 mm

Bone Levers

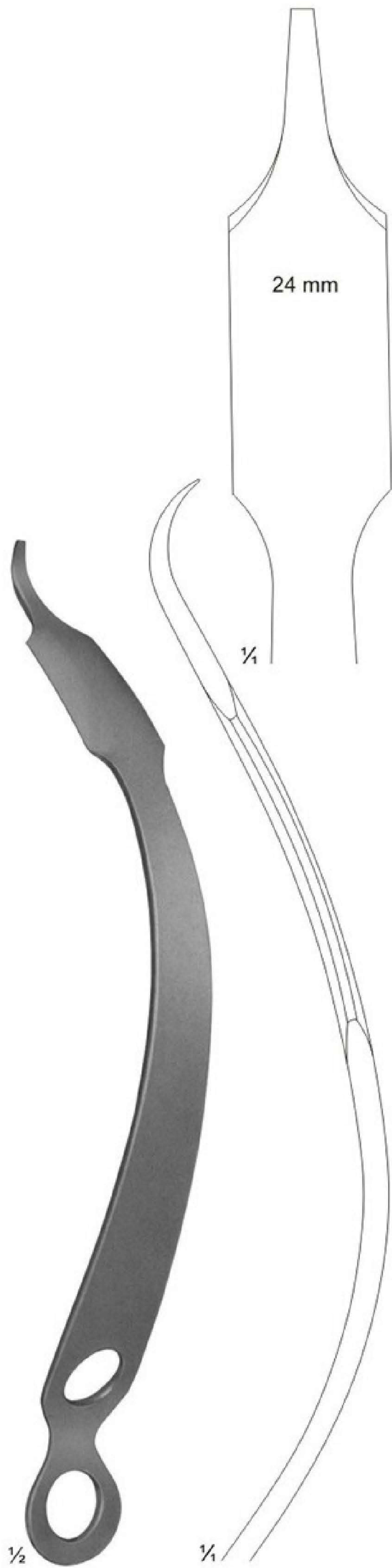

06-8065
HOHMANN-ALDINGER
270 mm



06-8066
SCHUMACHER mod. WAGNER
345 mm

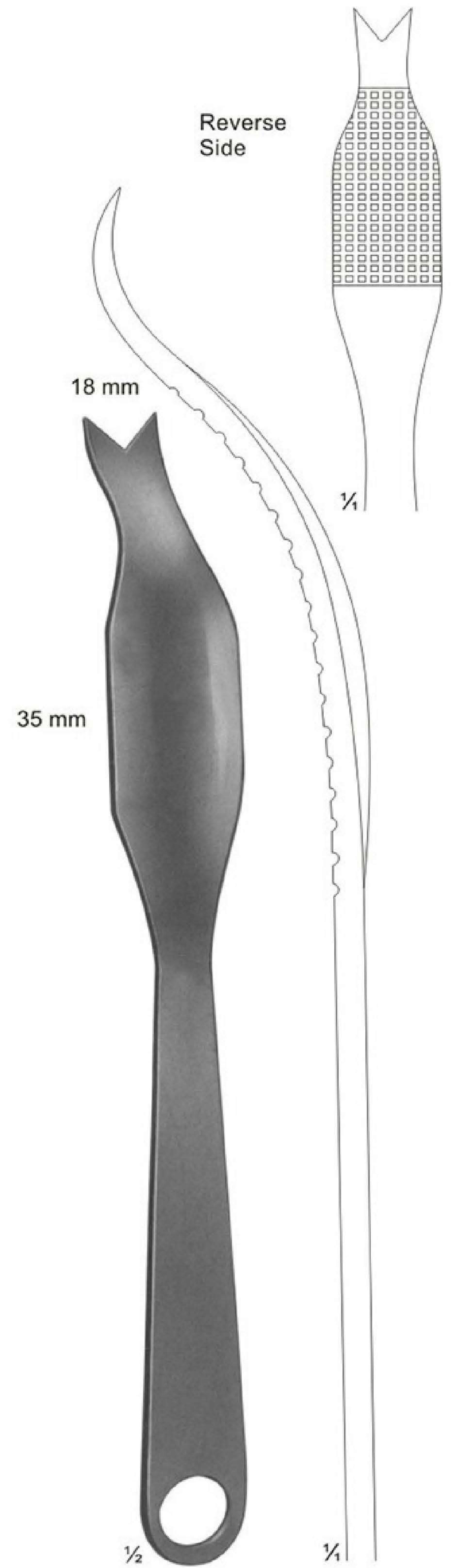

06-8067
SCHUMACHER
290 mm

Special Bone Levers

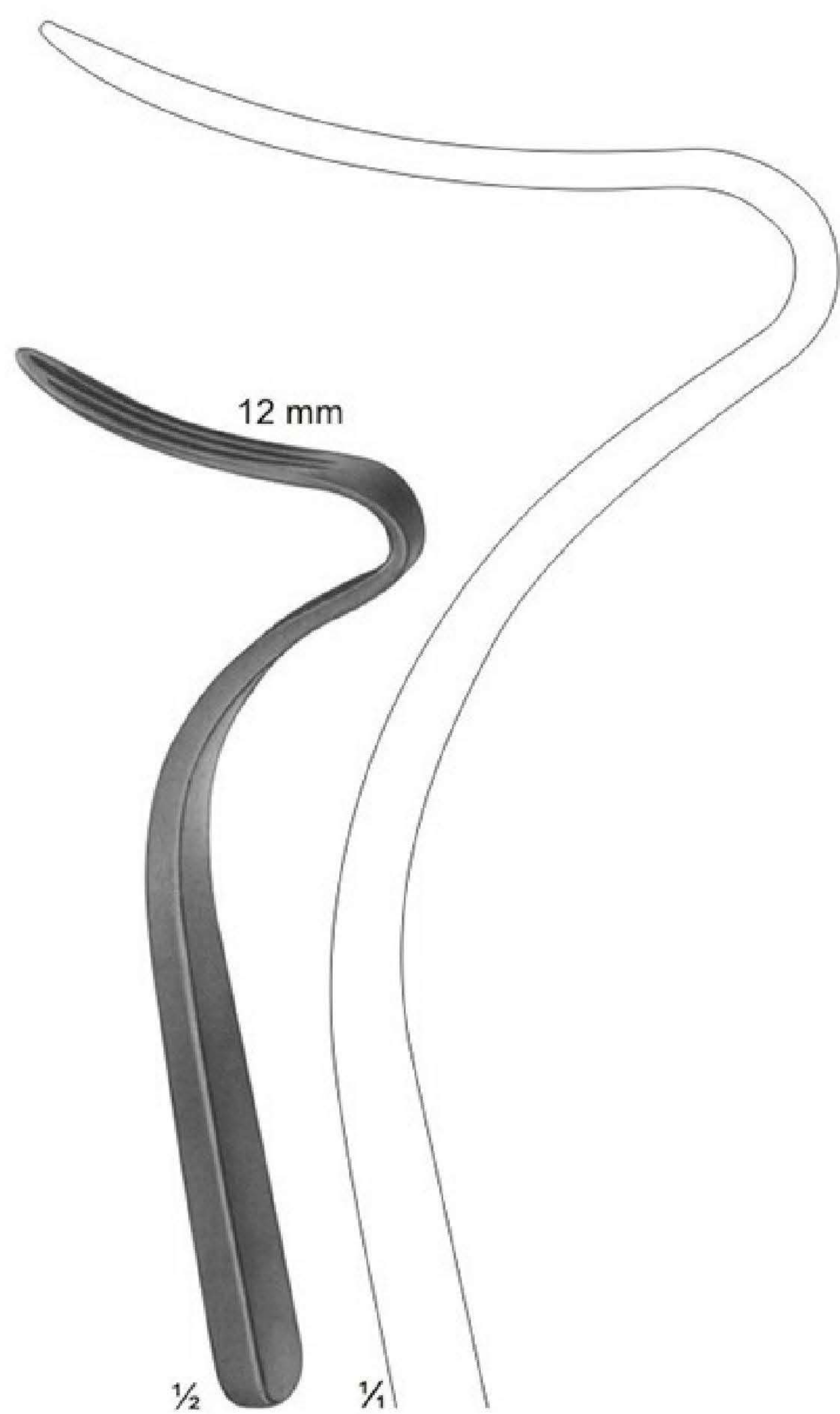

06-8068
TAGER
Bone lever for
angle joint operations
175 mm

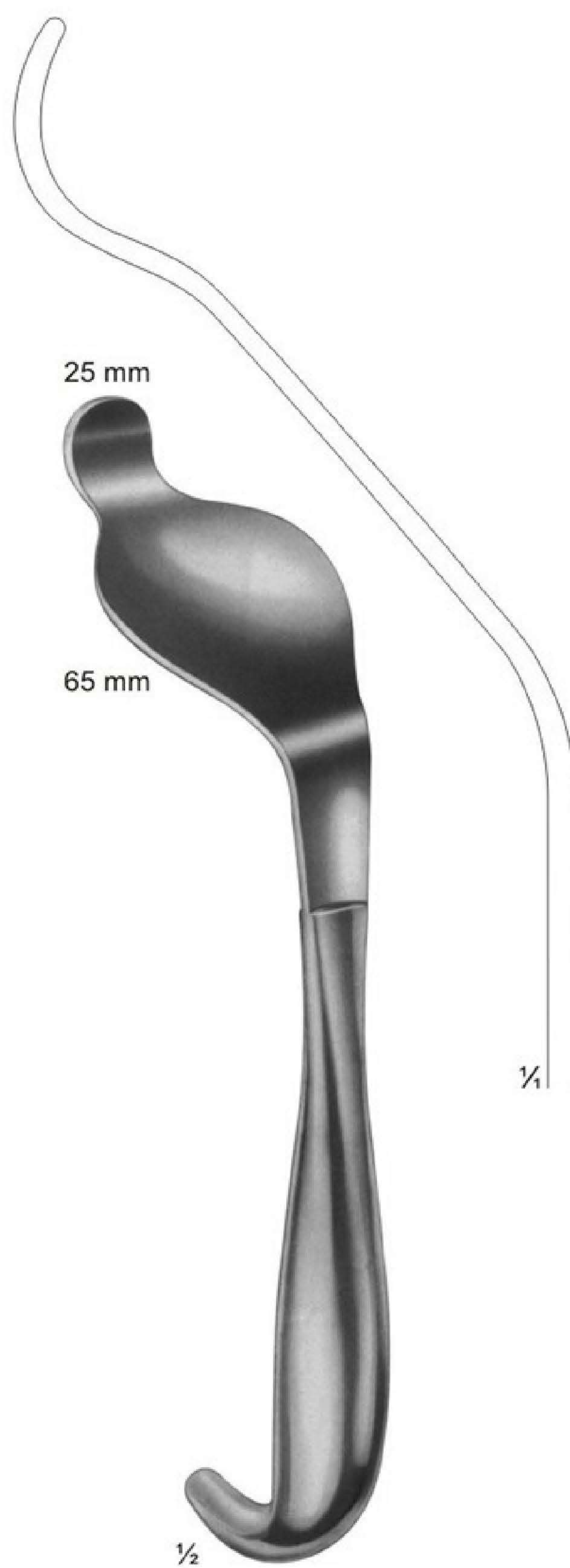

06-8069
BENNETT
235 mm

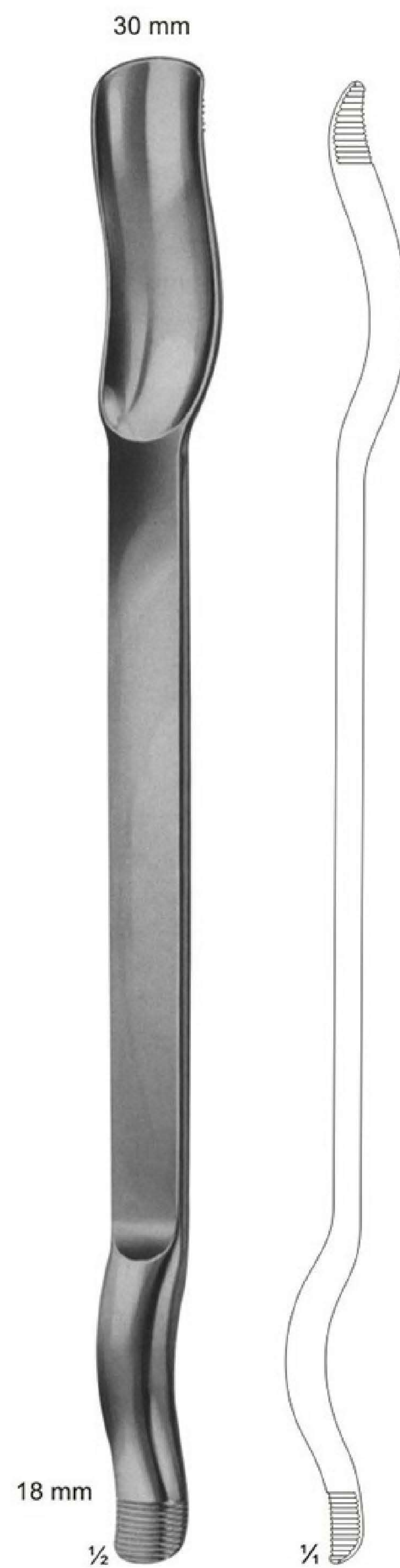

06-8070
MURPHY-LANE
Luxation lever
340 mm

Raspatories

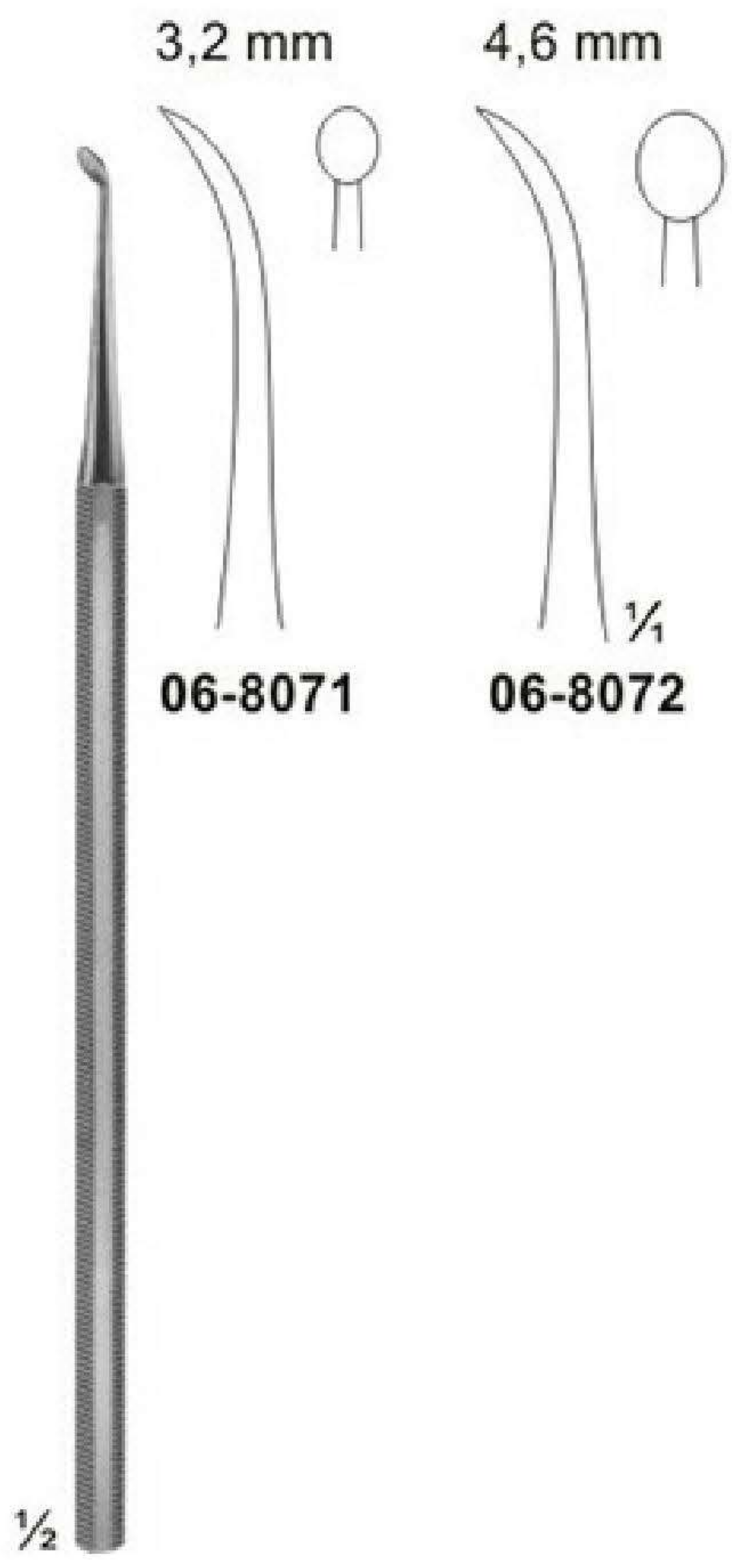

06-8071 - 06-8072
PARTSCH
150 mm

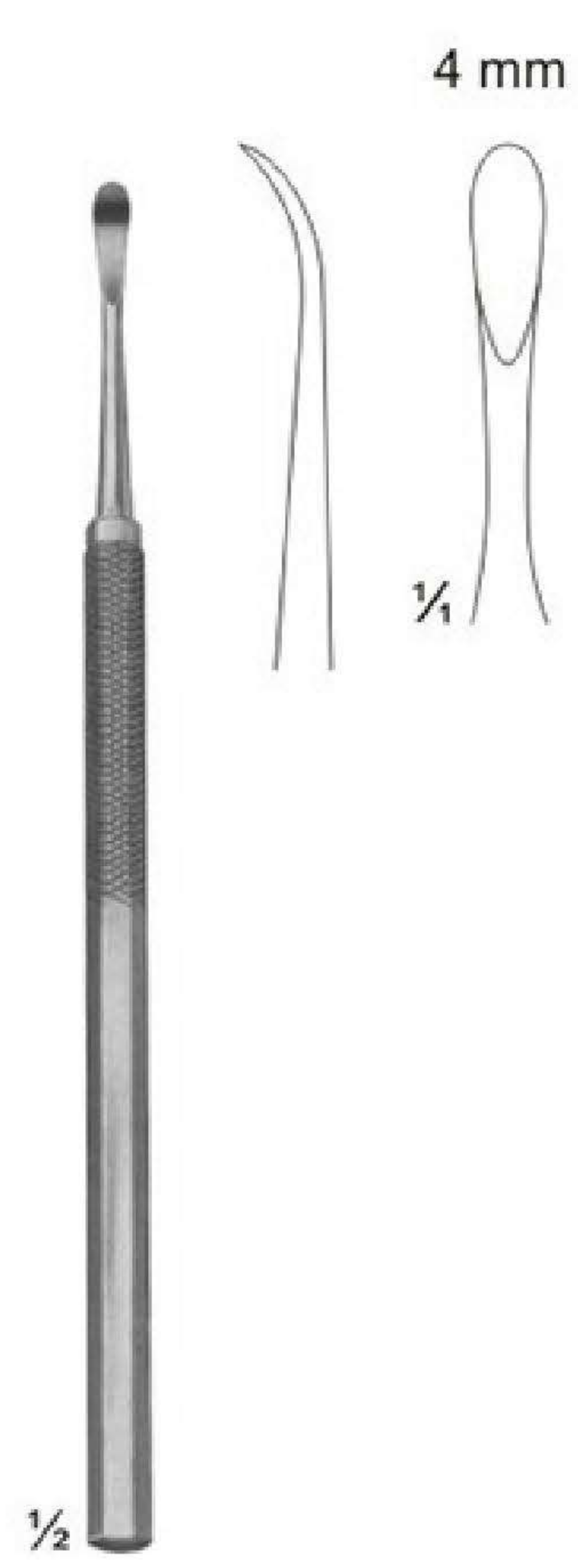

06-8073
PARTSCH mod. LANGE
145 mm

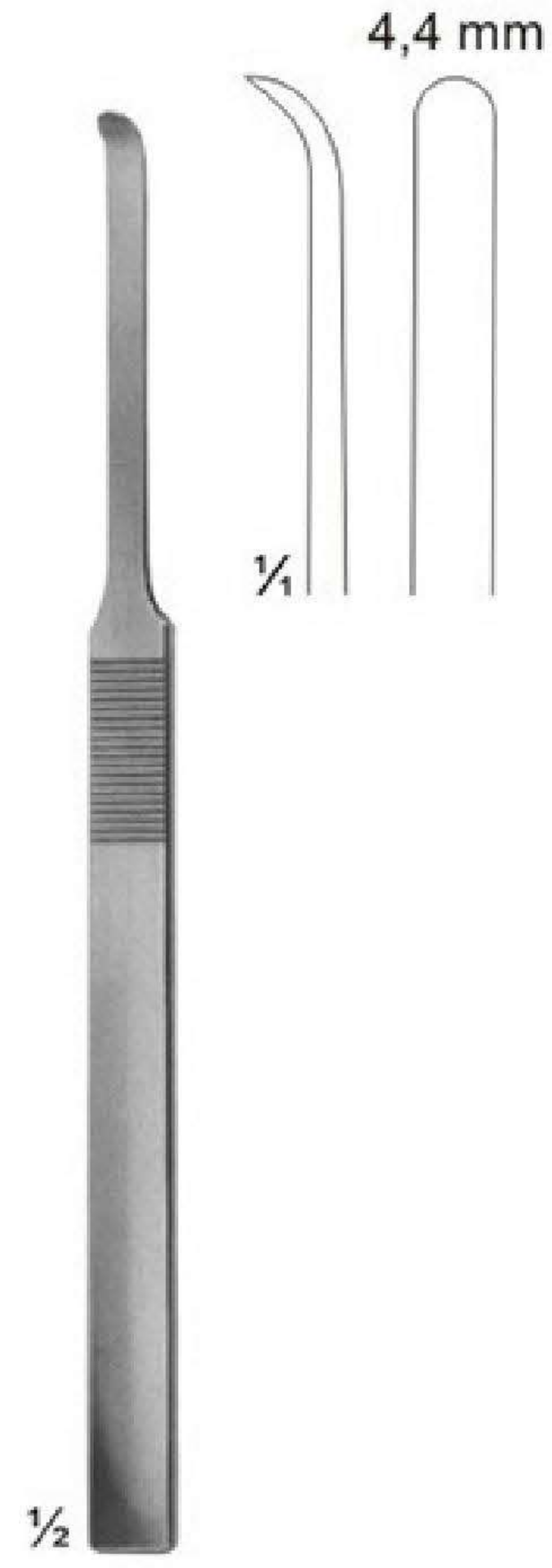

06-8074
MC KENTY
155 mm

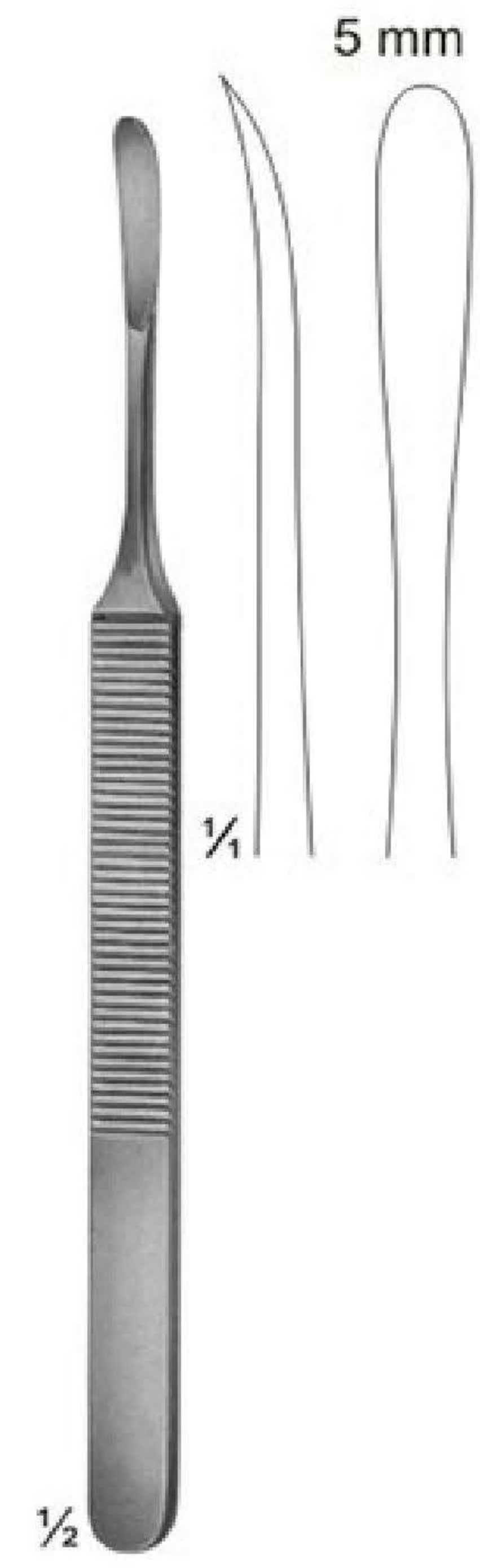

06-8075
KOENIG
155 mm

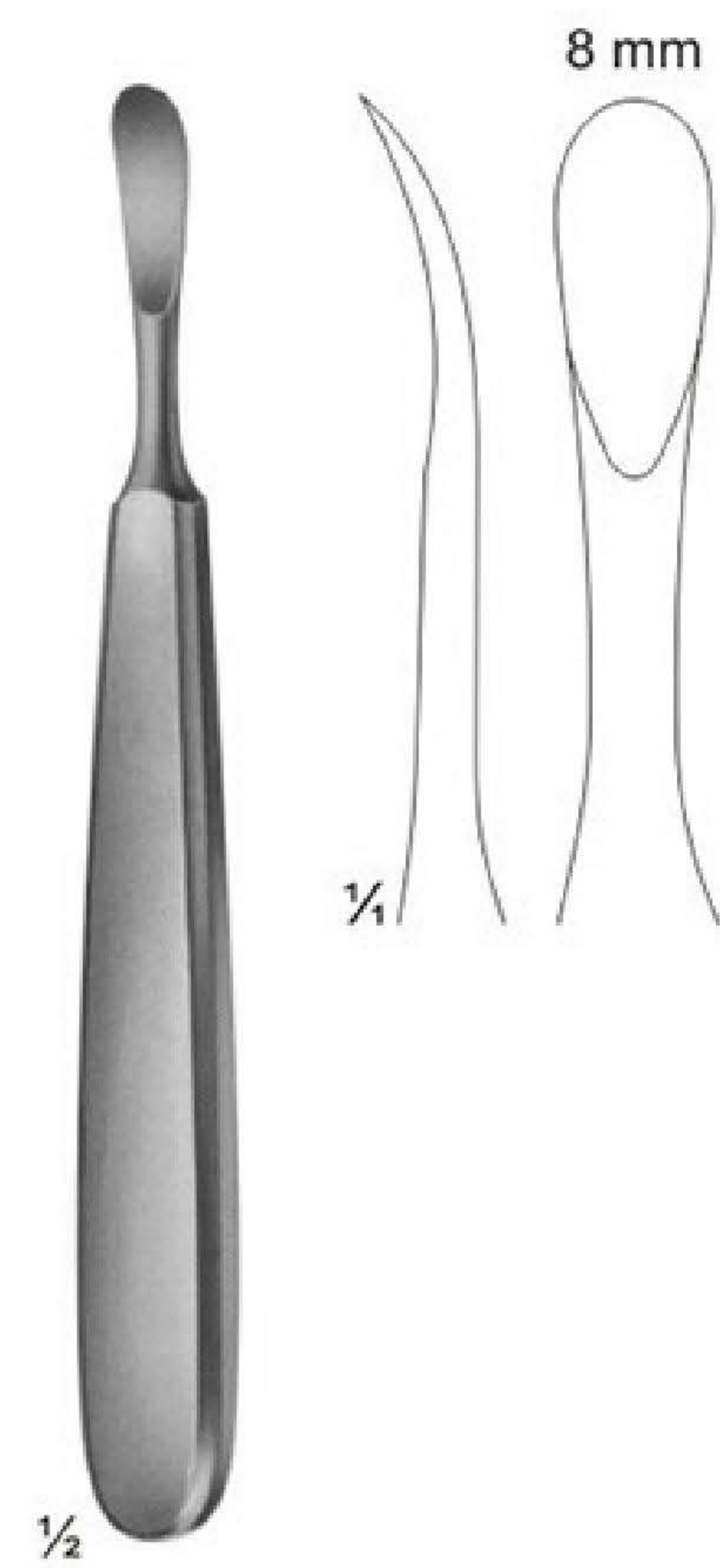

06-8076
TRELAT
150 mm

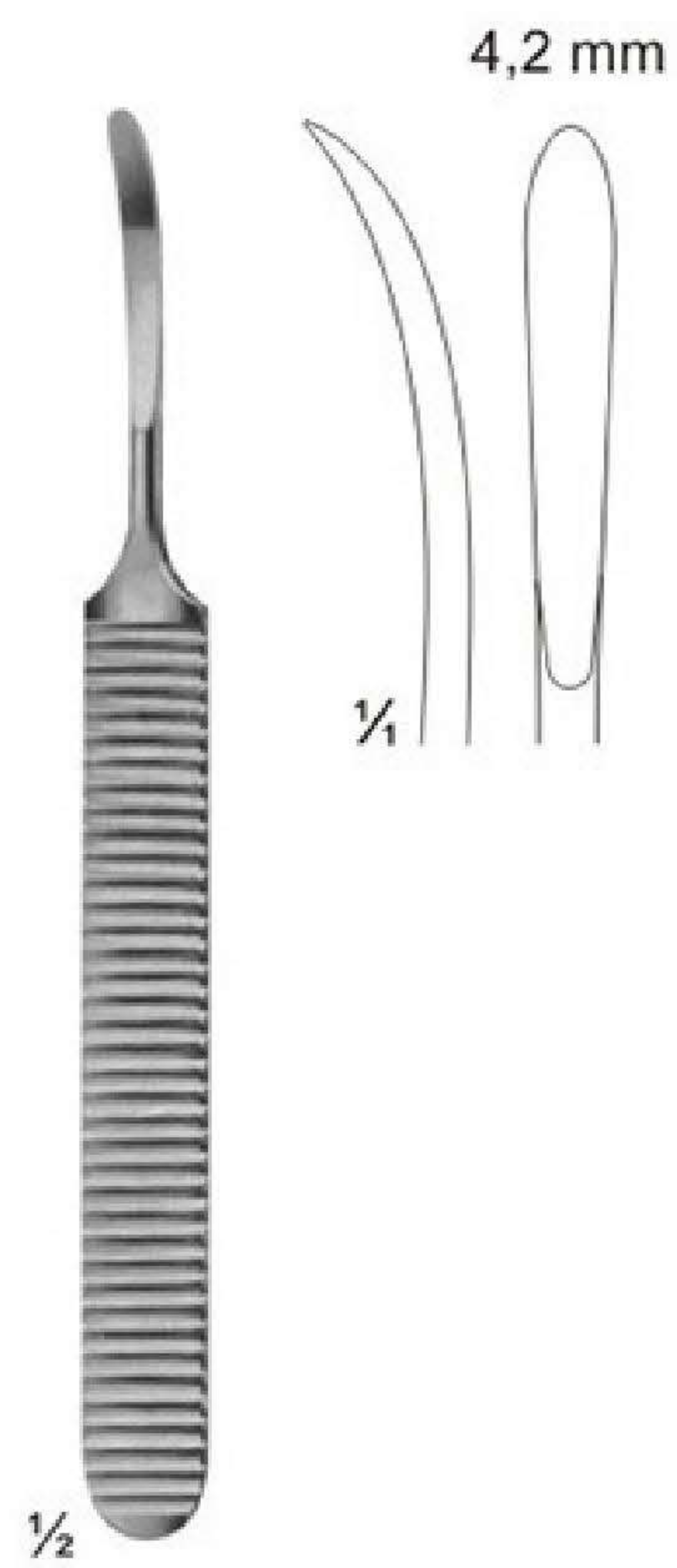

06-8077
WILLIGER
140 mm

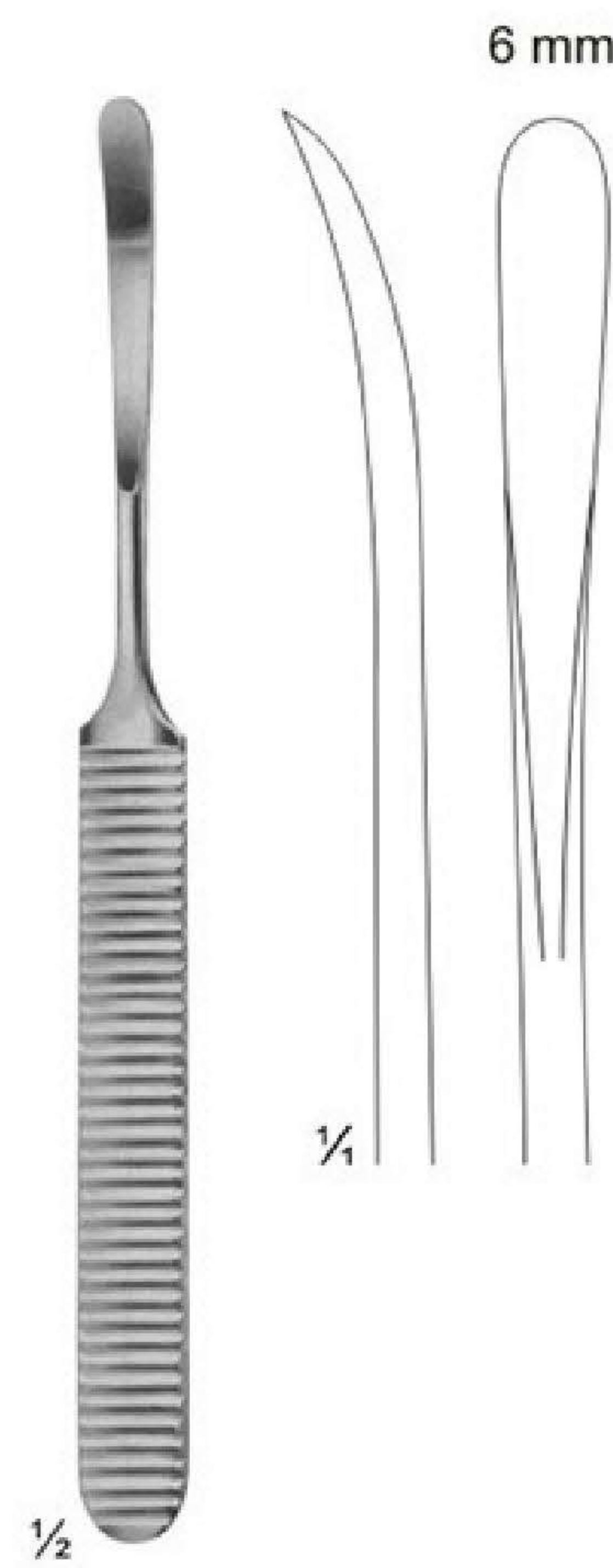

06-8078
WILLIGER
160 mm

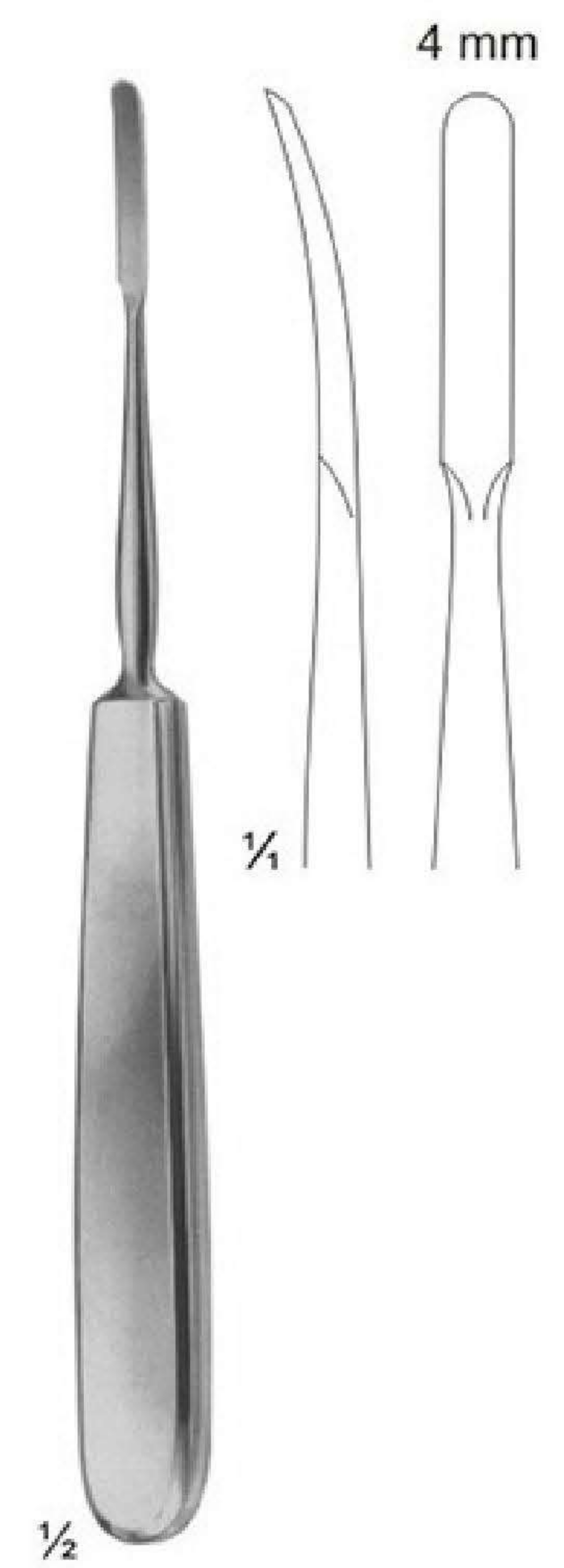

06-8079
JOSEPH
170 mm

Raspatories

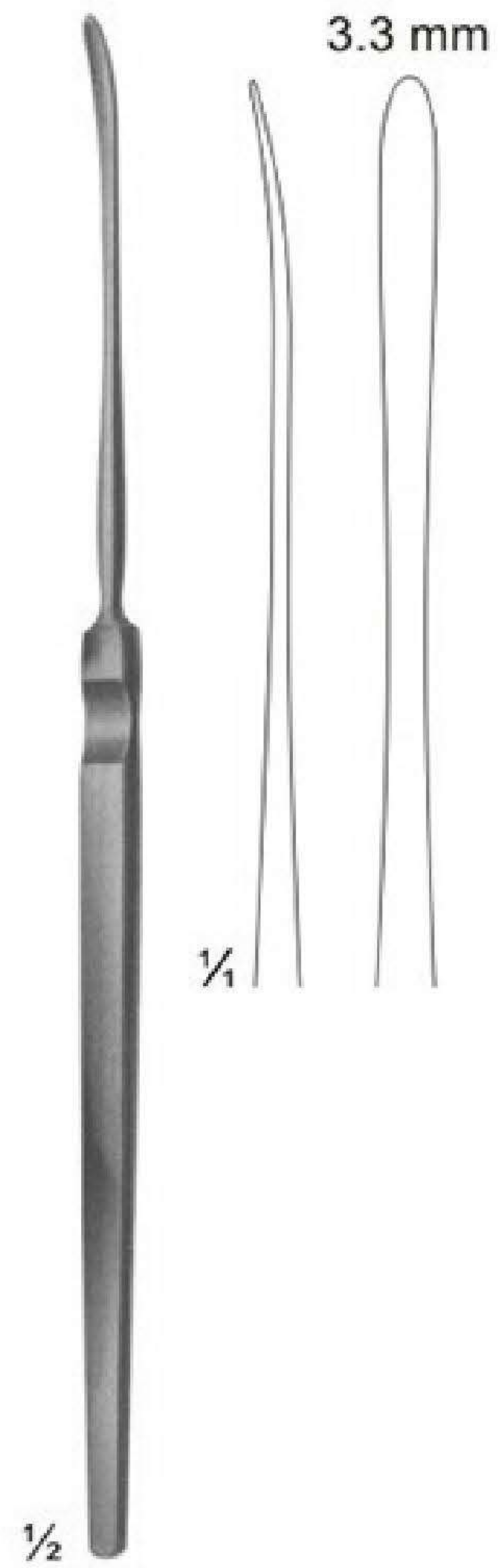

06-8080
HALLE
blunt
180 mm



06-8081
FREER
blunt
190 mm



06-8082
FREER
sharp
190 mm

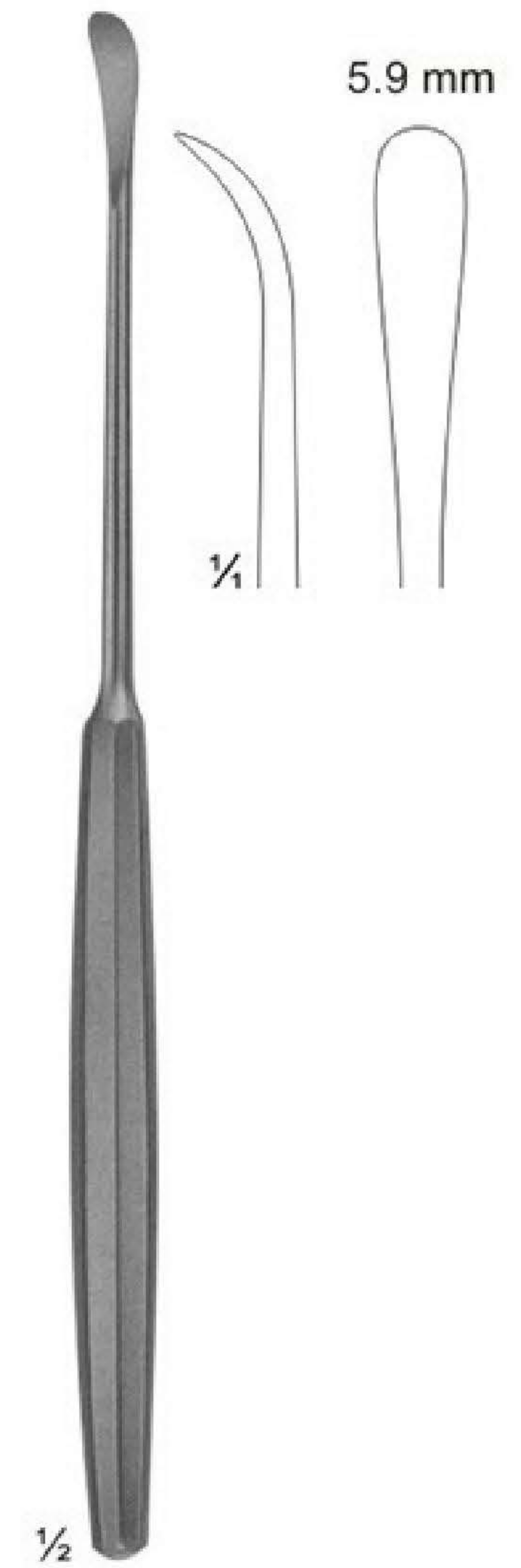

06-8083
SEWALL
blunt
200 mm

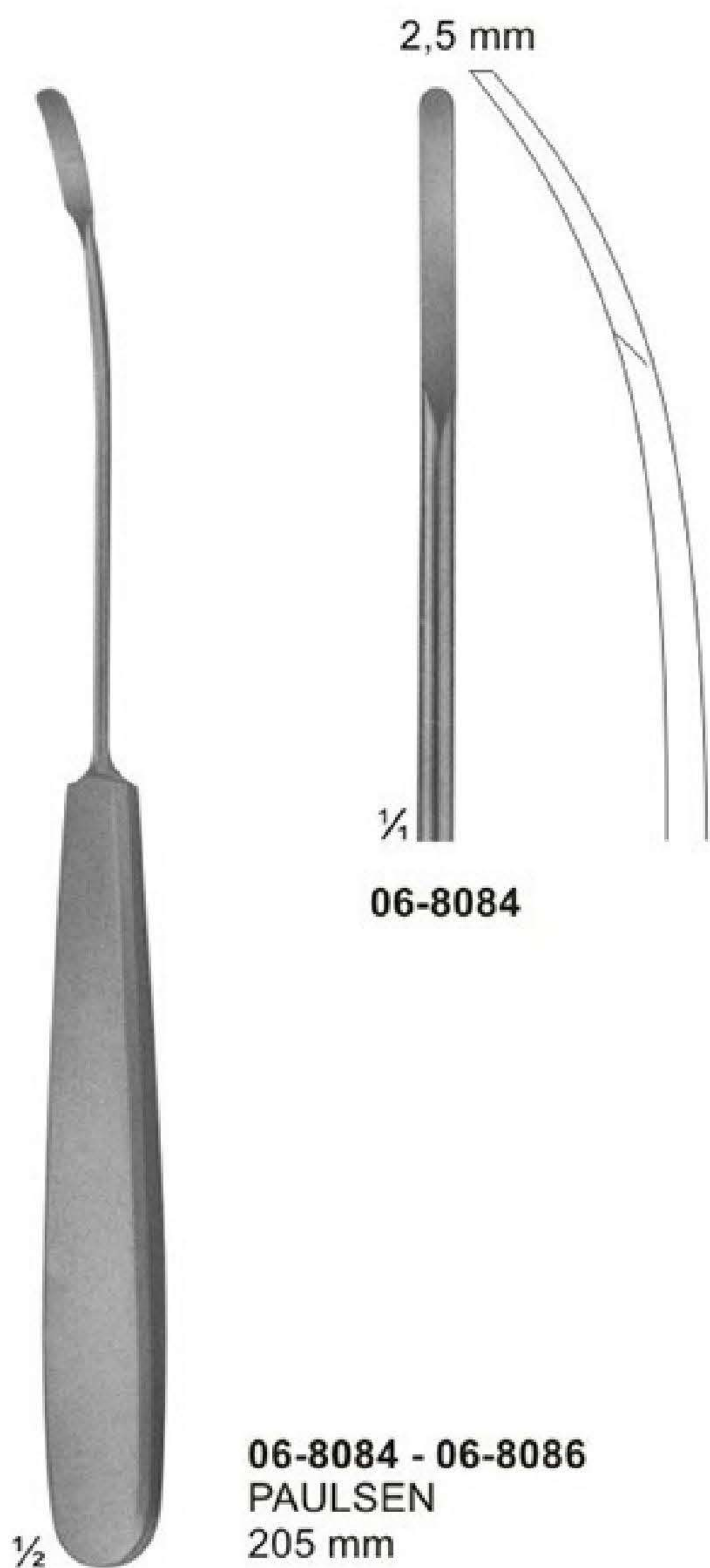

06-8084



06-8085



06-8086

06-8084 - 06-8086
PAULSEN
205 mm



06-8087

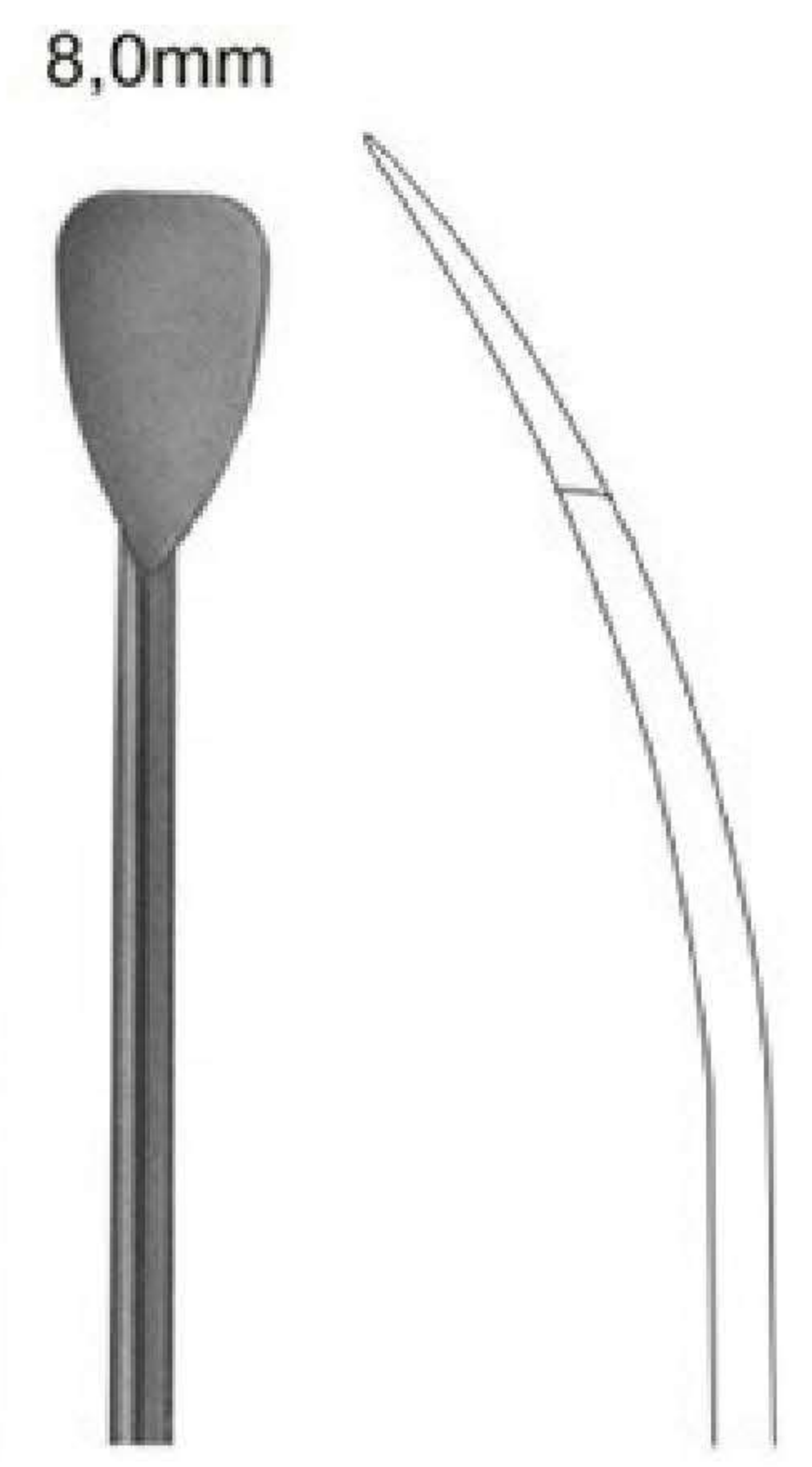

06-8088

06-8087 - 06-8088
PAULSEN
205 mm

Raspatories

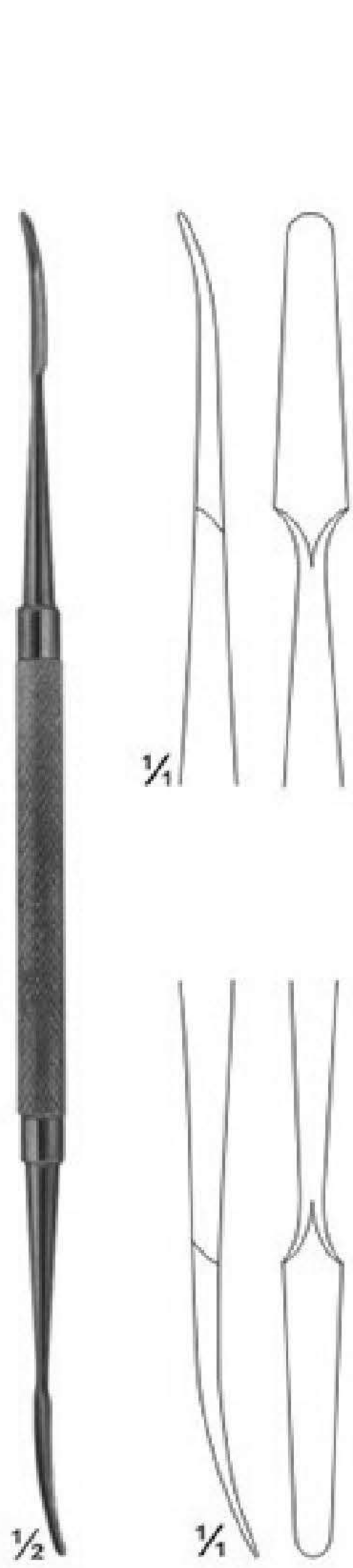

06-8089
KILLIAN
sharp/blunt
185 mm

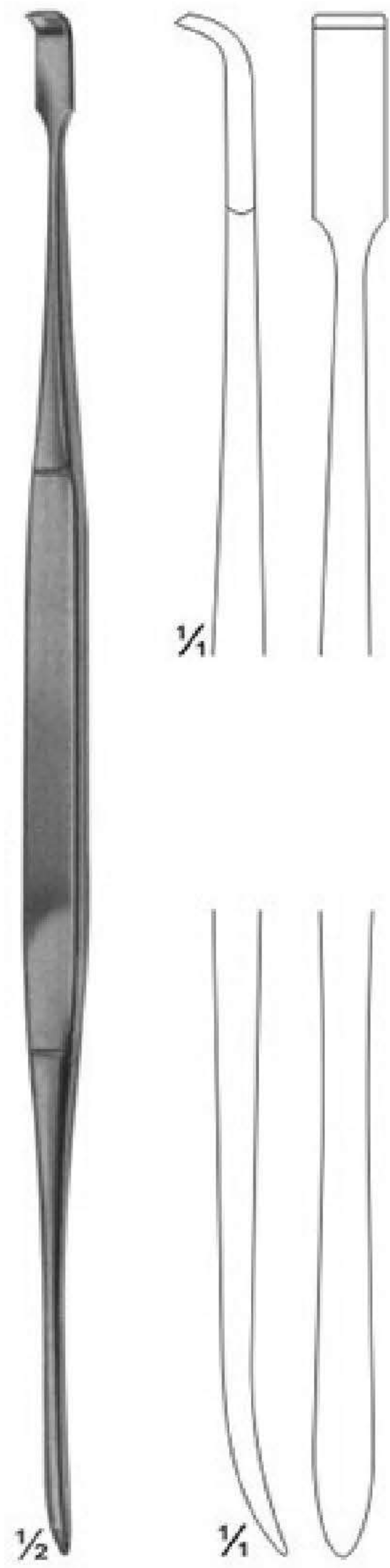

06-8090
HOWARTH
sharp/blunt
215 mm

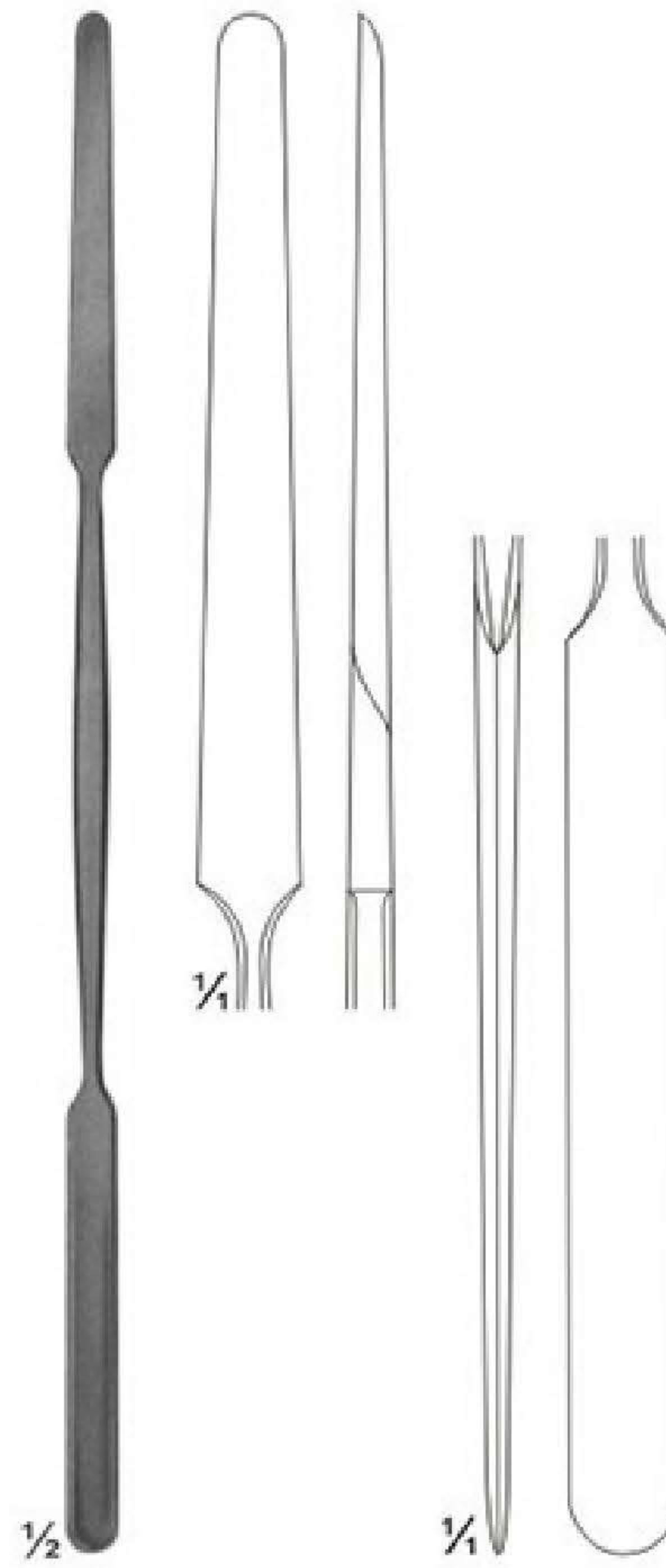

06-8091
KILLIAN
sharp/blunt
185 mm

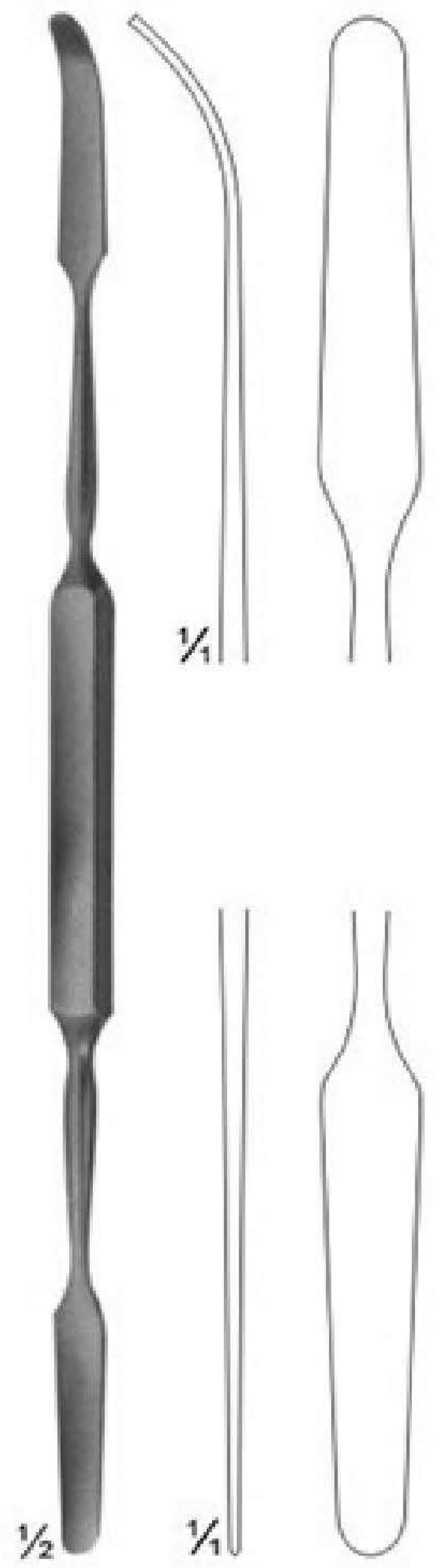

06-8092
MAC DONALD
blunt/blunt
185 mm

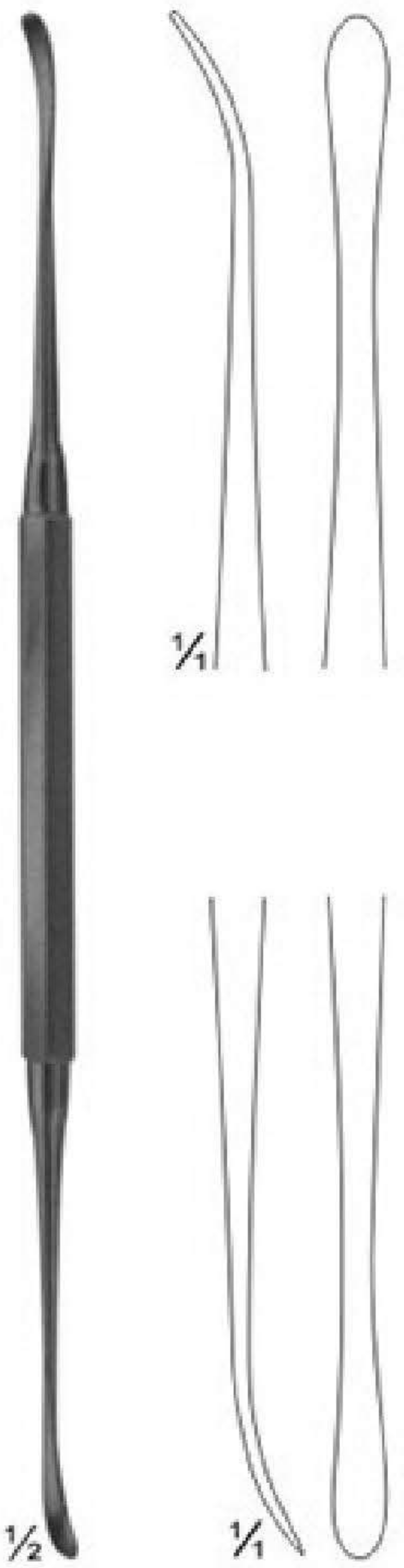

06-8093
FREER
sharp/blunt
185 mm

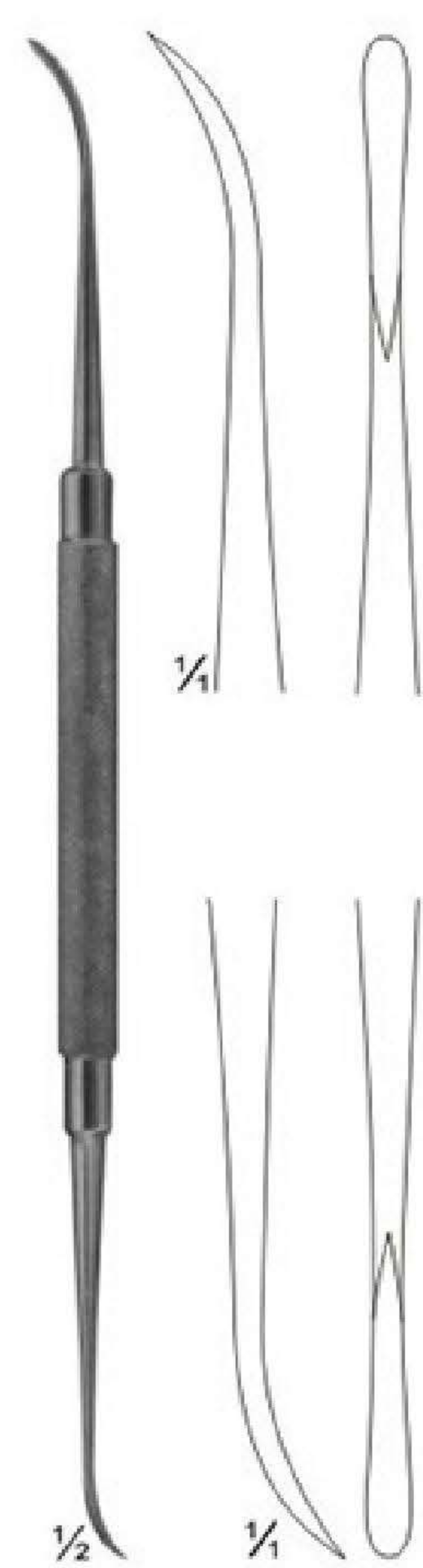

06-8094
FREER-YASARGIL
sharp/sharp
185 mm

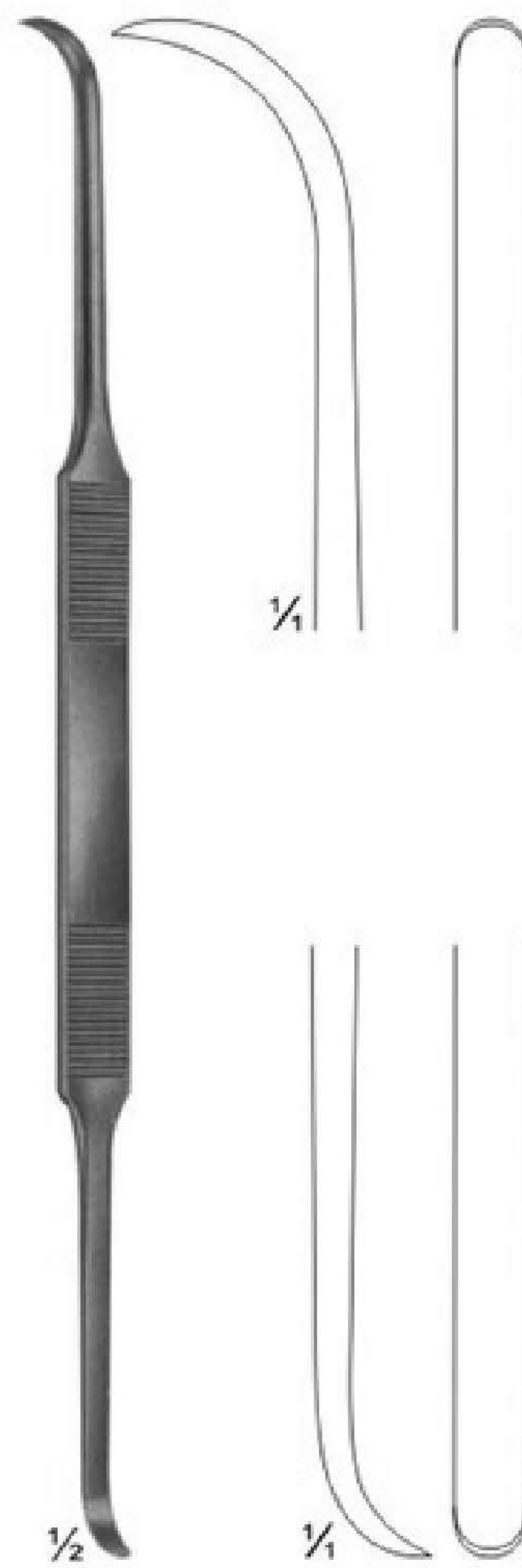

06-8095
COTTLE
sharp/sharp
200 mm

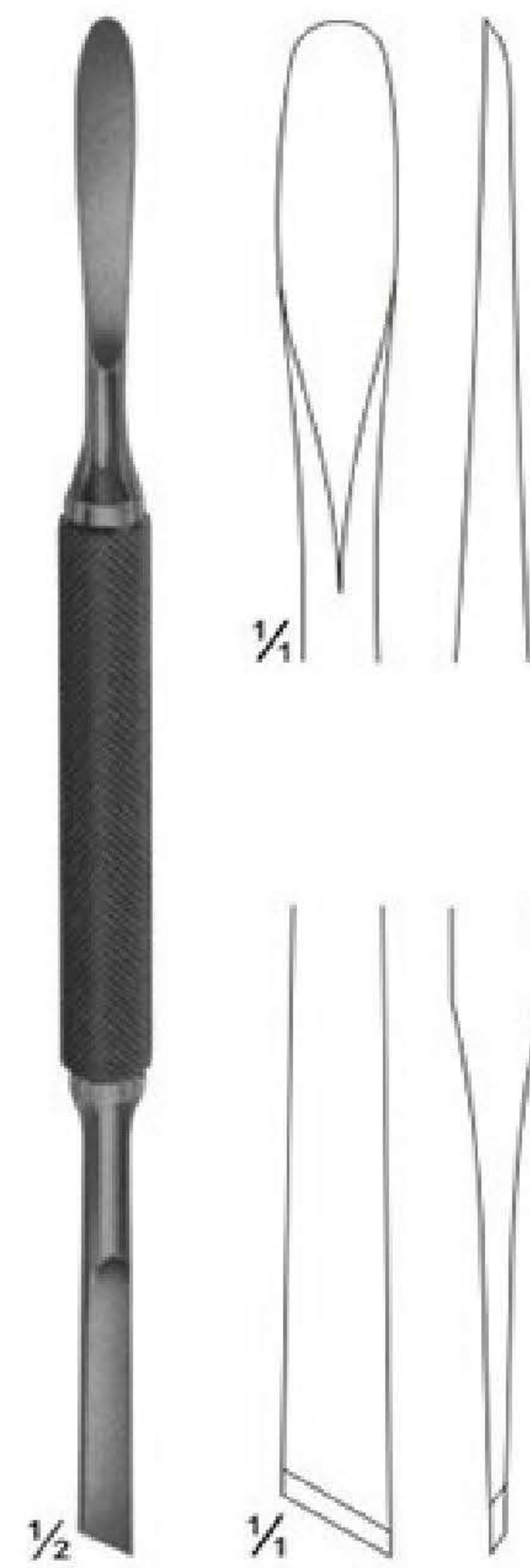

06-8096
MEAD
sharp/sharp
165 mm

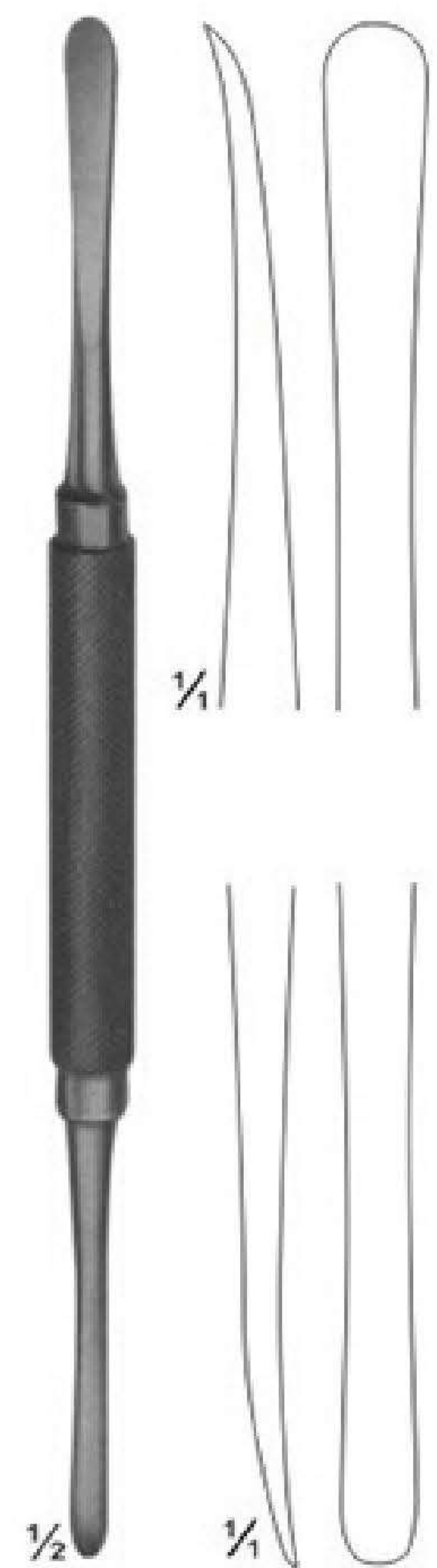

06-8097
MOLT
sharp/sharp
180 mm

Raspatories

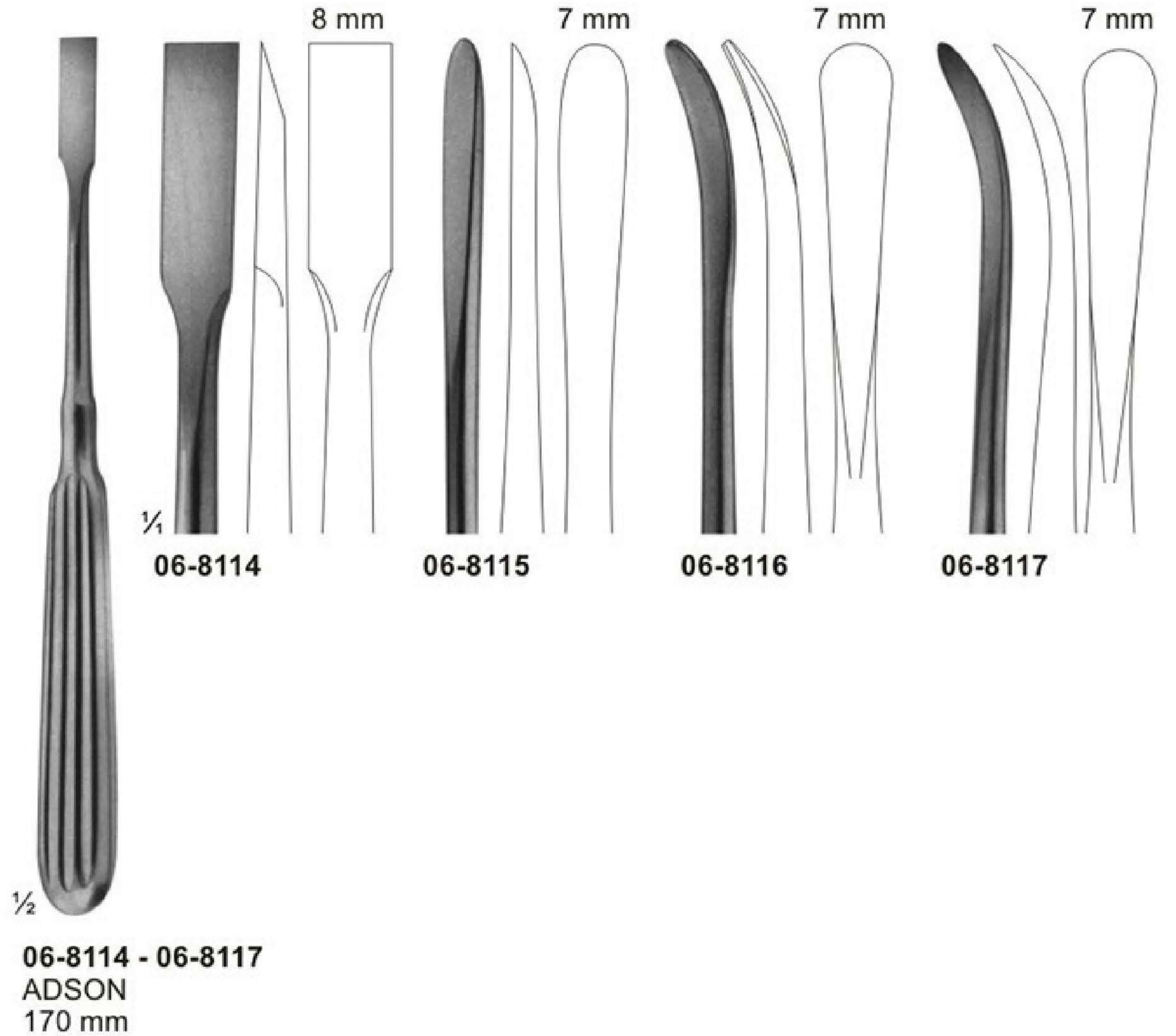
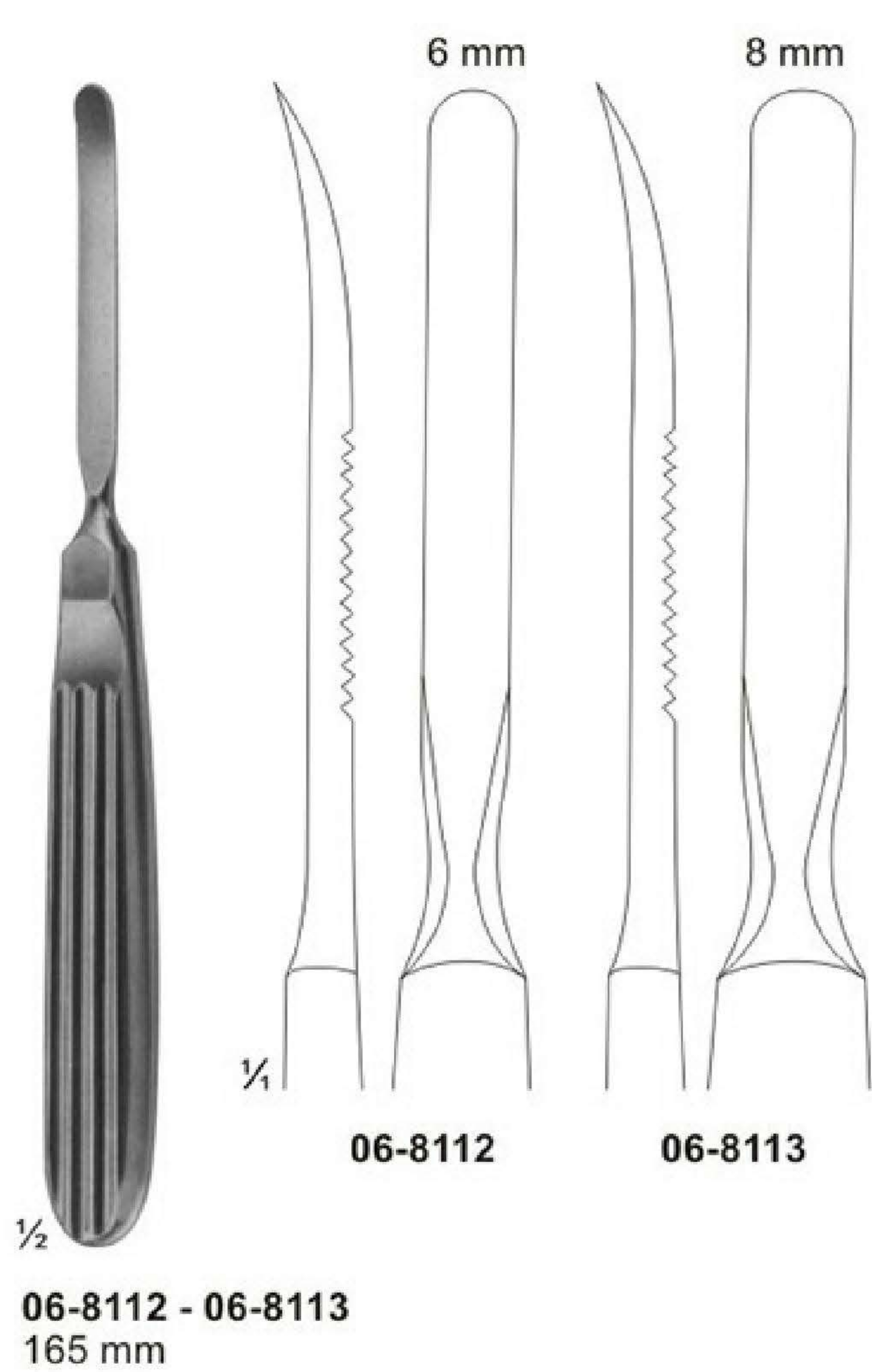
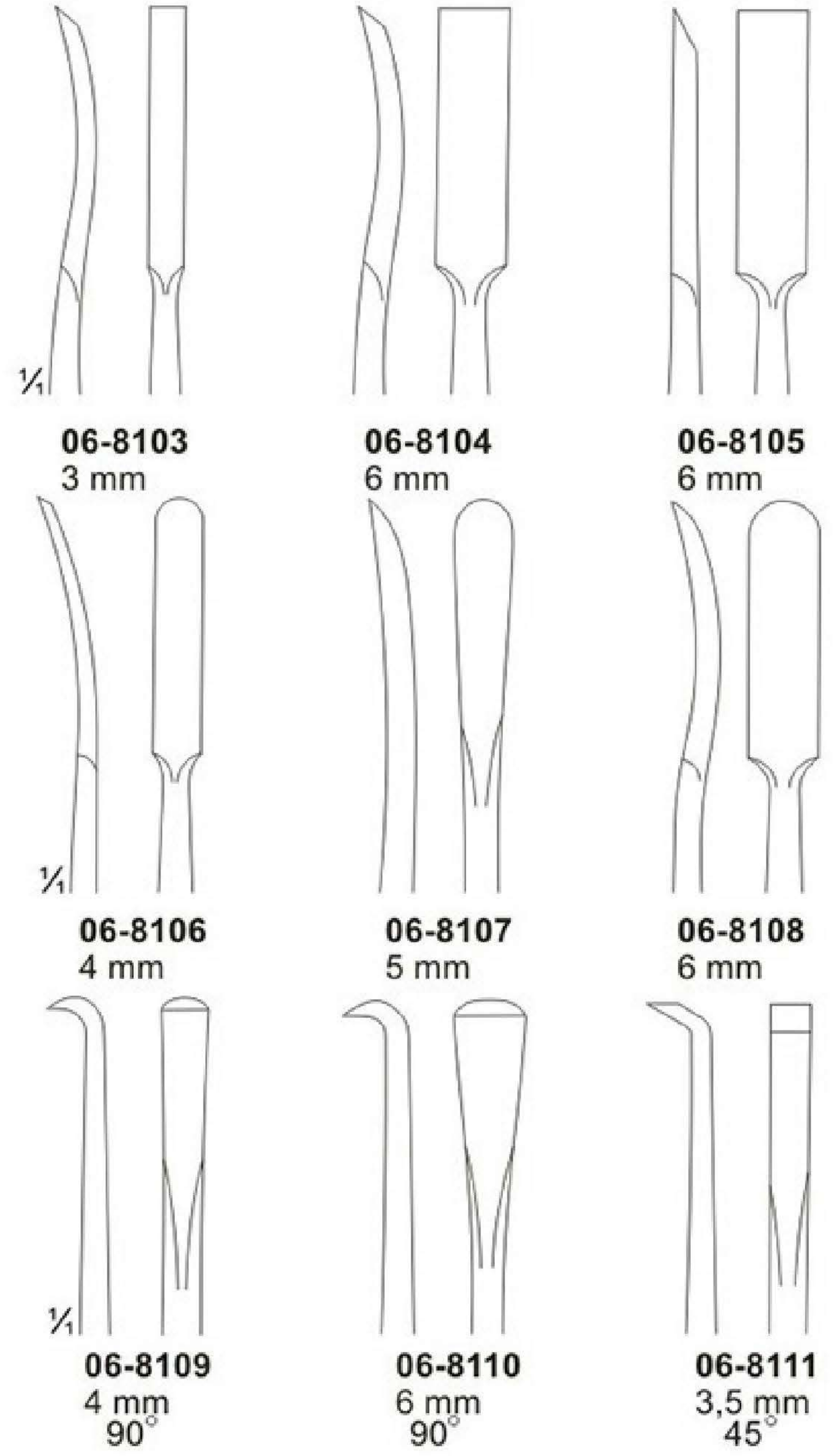
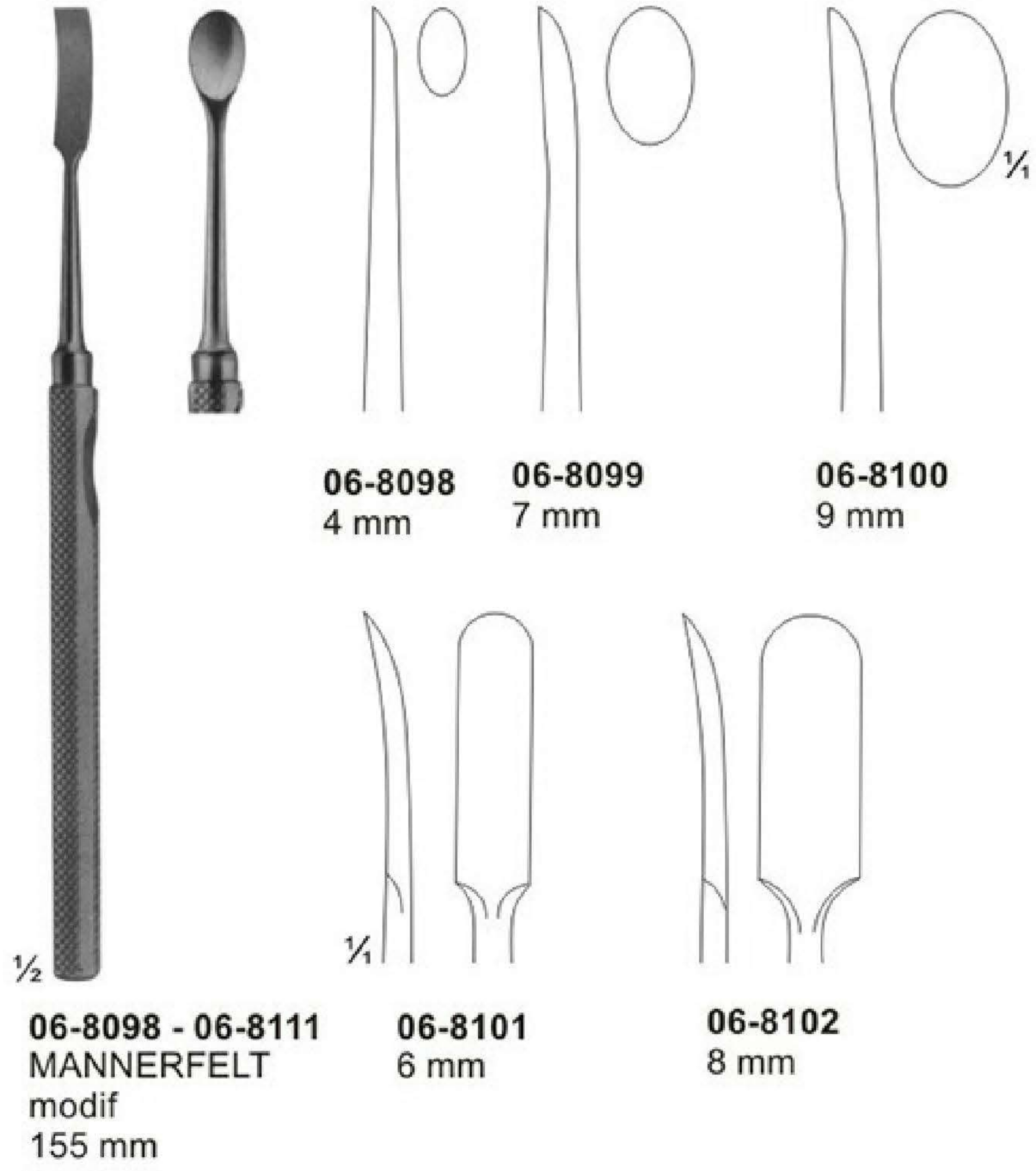

Raspatories

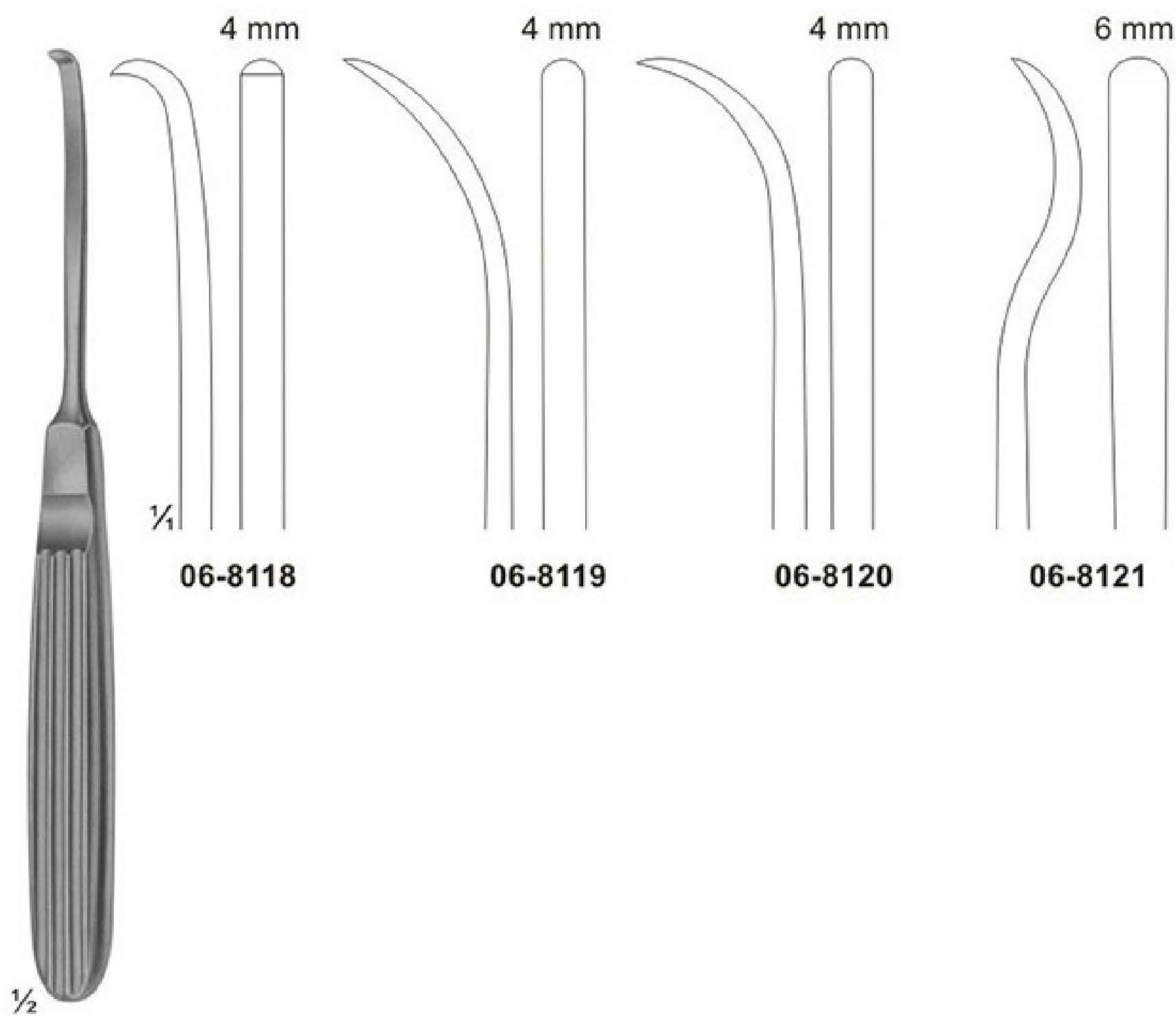

06-8118 - 06-8121
 MUEHLING
 170 mm

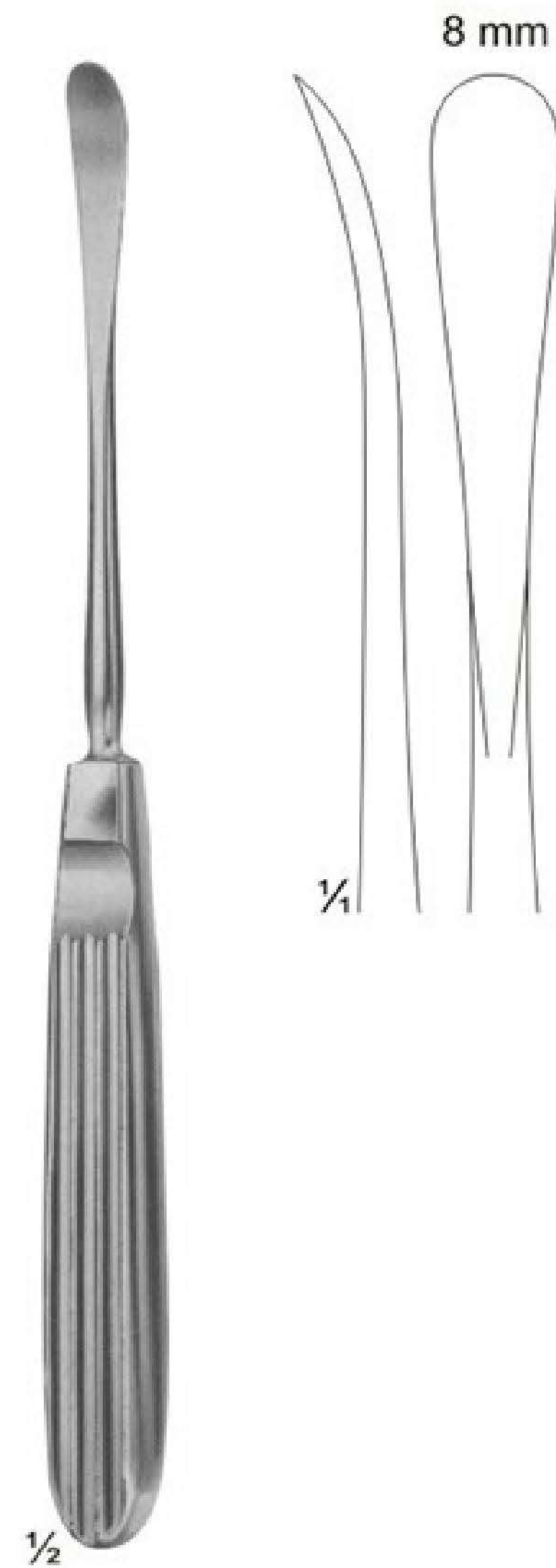

06-8122
 COTTLE
 195 mm

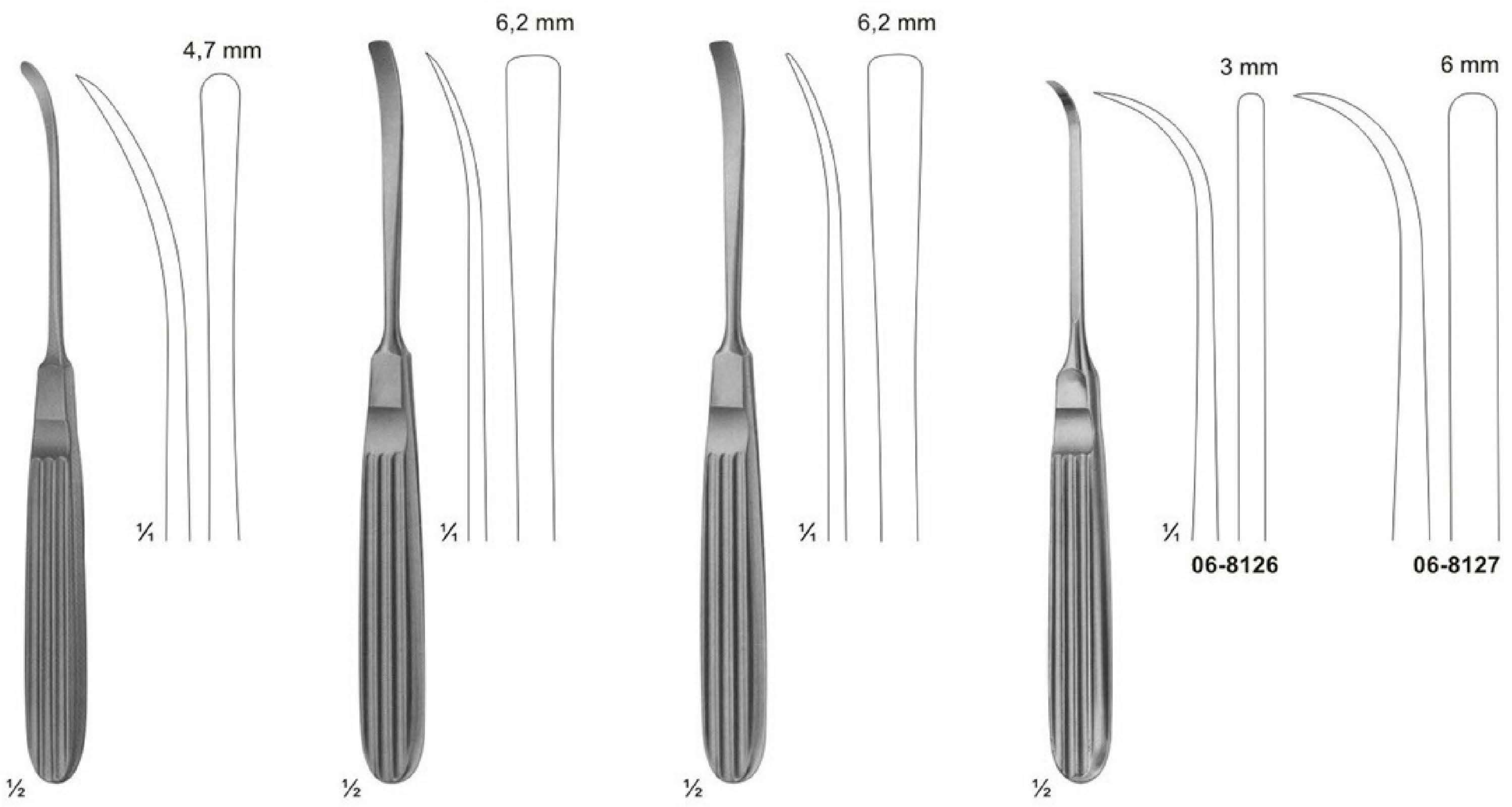

06-8123
 LANDOLT
 175 mm

06-8124
 CASPAR
 180 mm

06-8125
 CASPAR
 180 mm

06-8126 - 06-8127
 170 mm

Raspatories

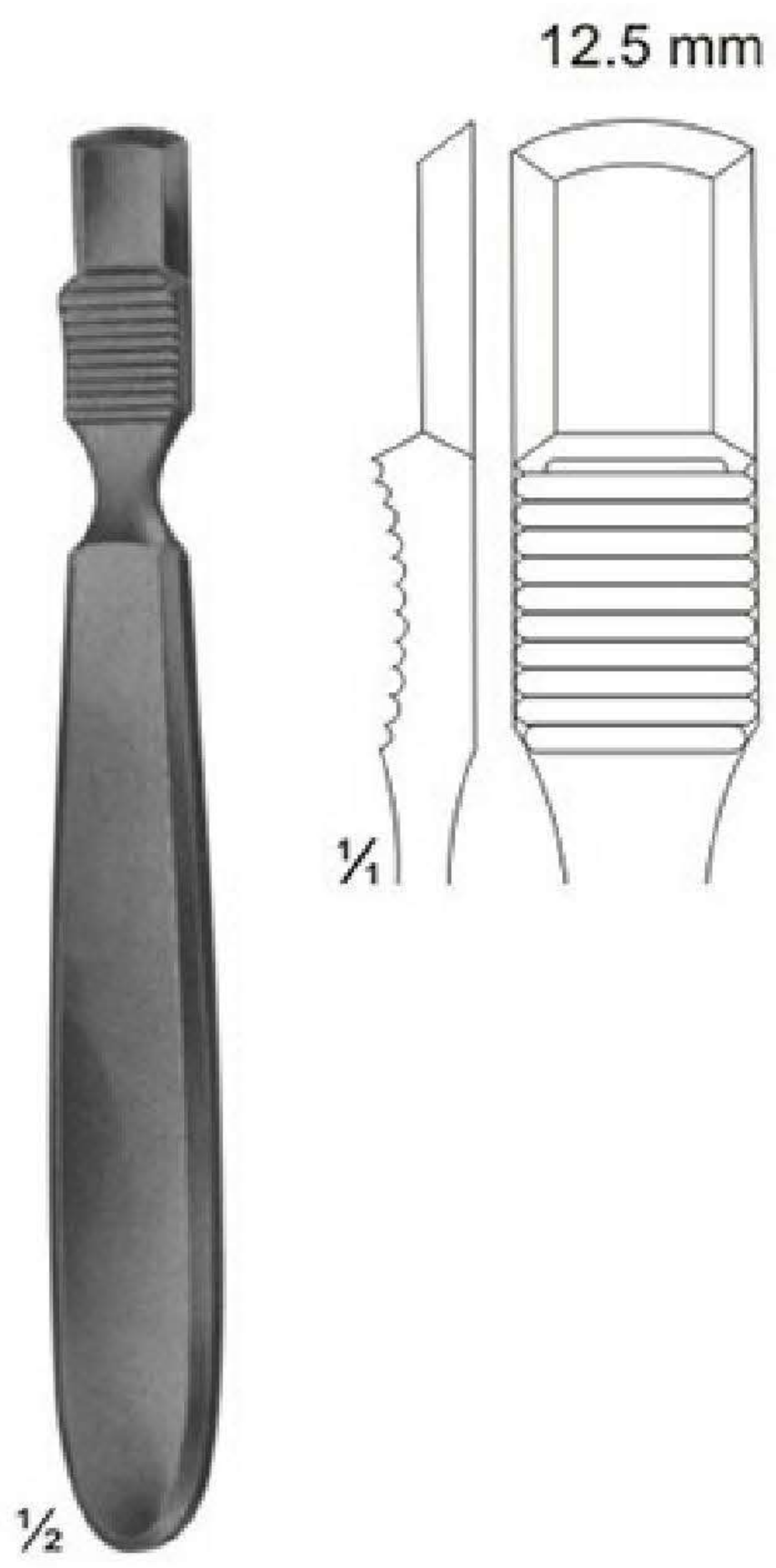

06-8128
FARABEUF
 140 mm

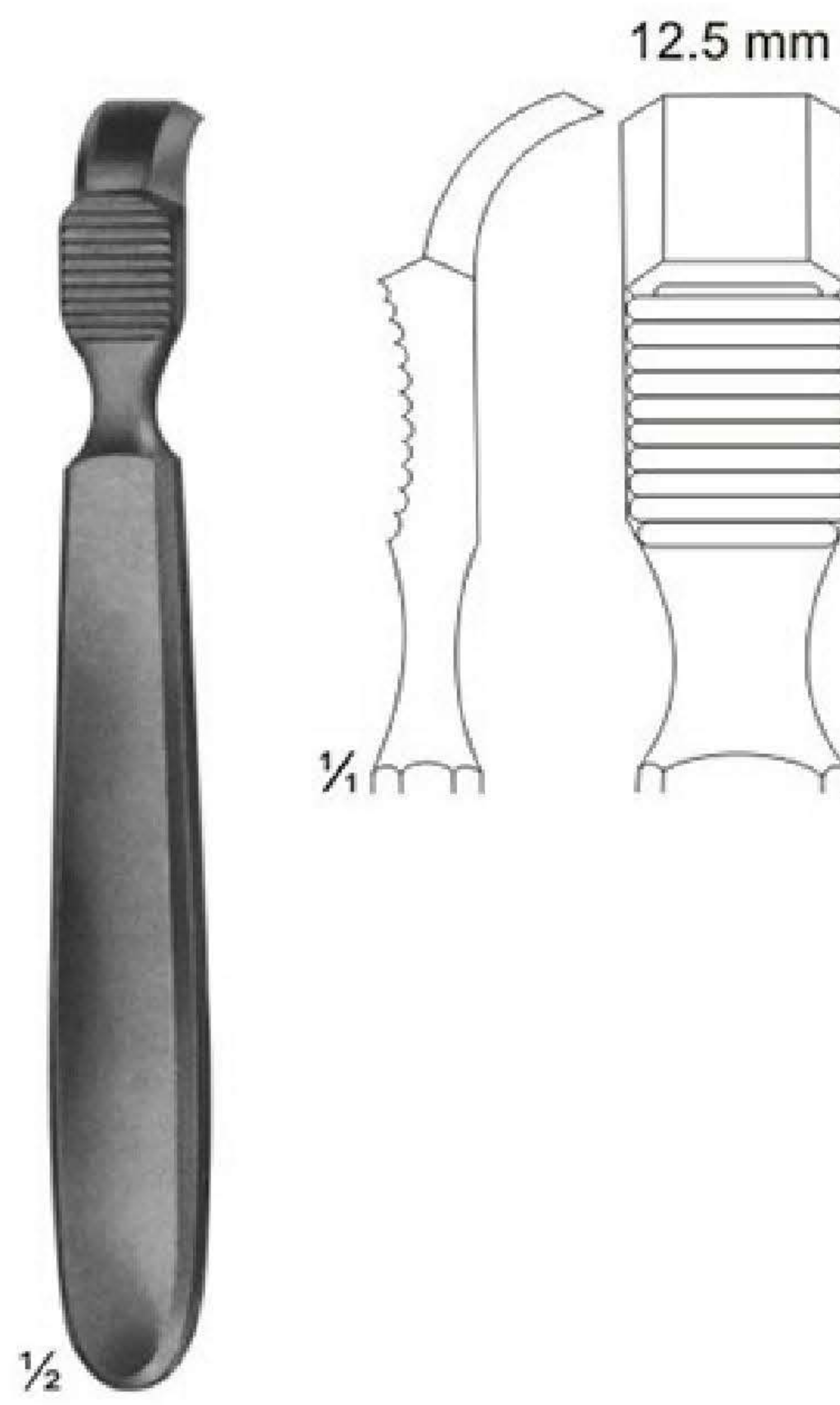

06-8129
FARABEUF
 140 mm

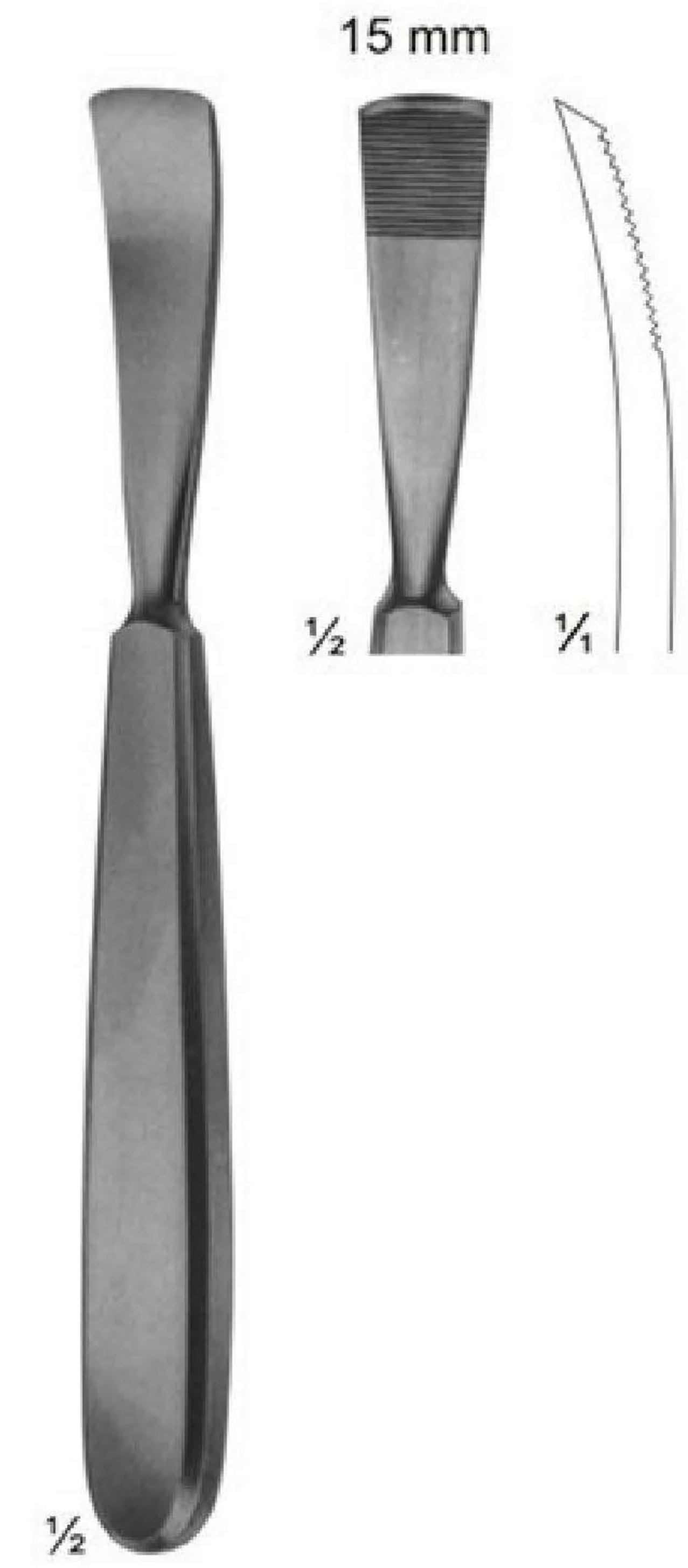

06-8130
JANSEN
 165 mm

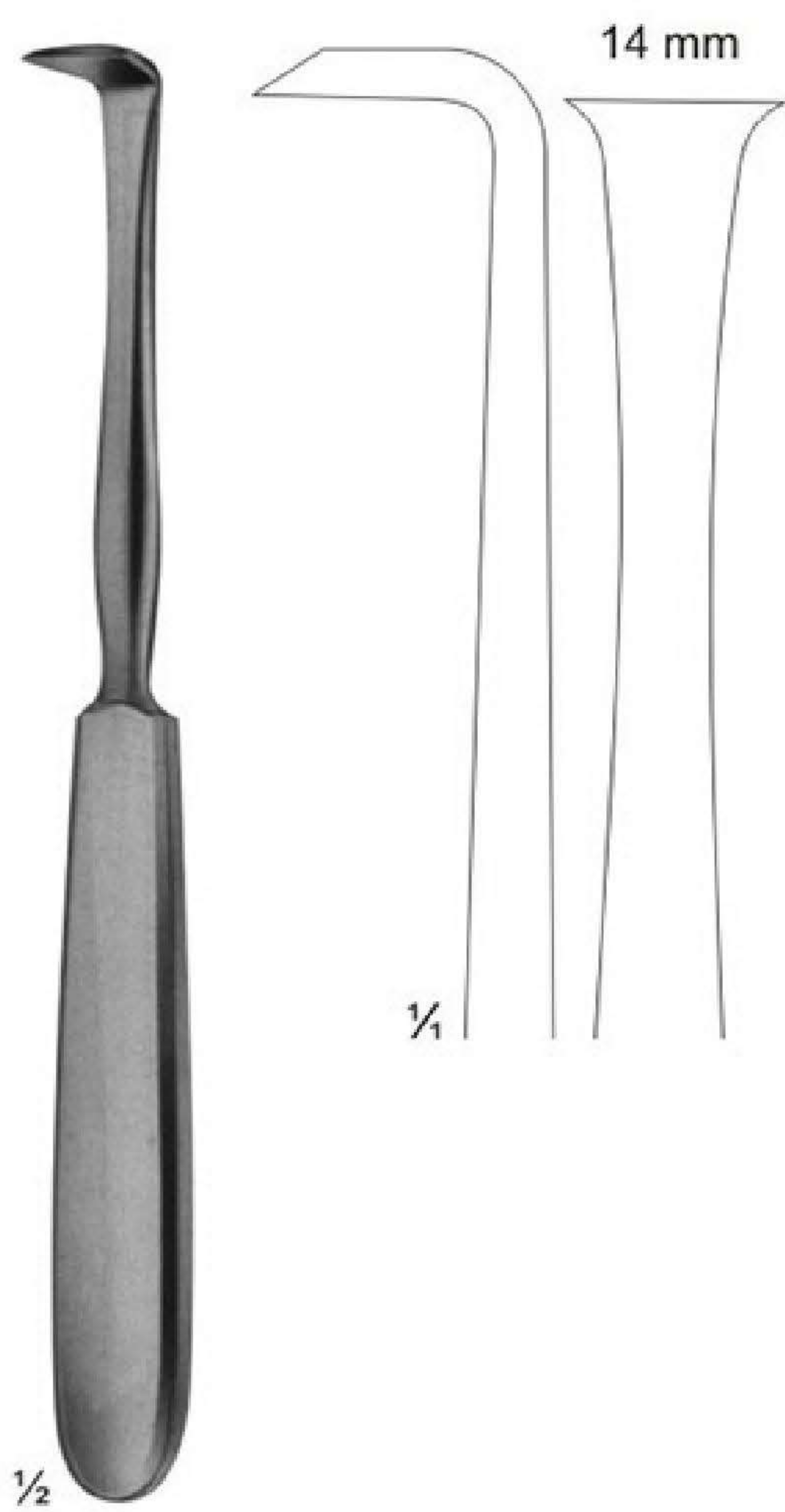

06-8131
LANGENBECK
 180 mm

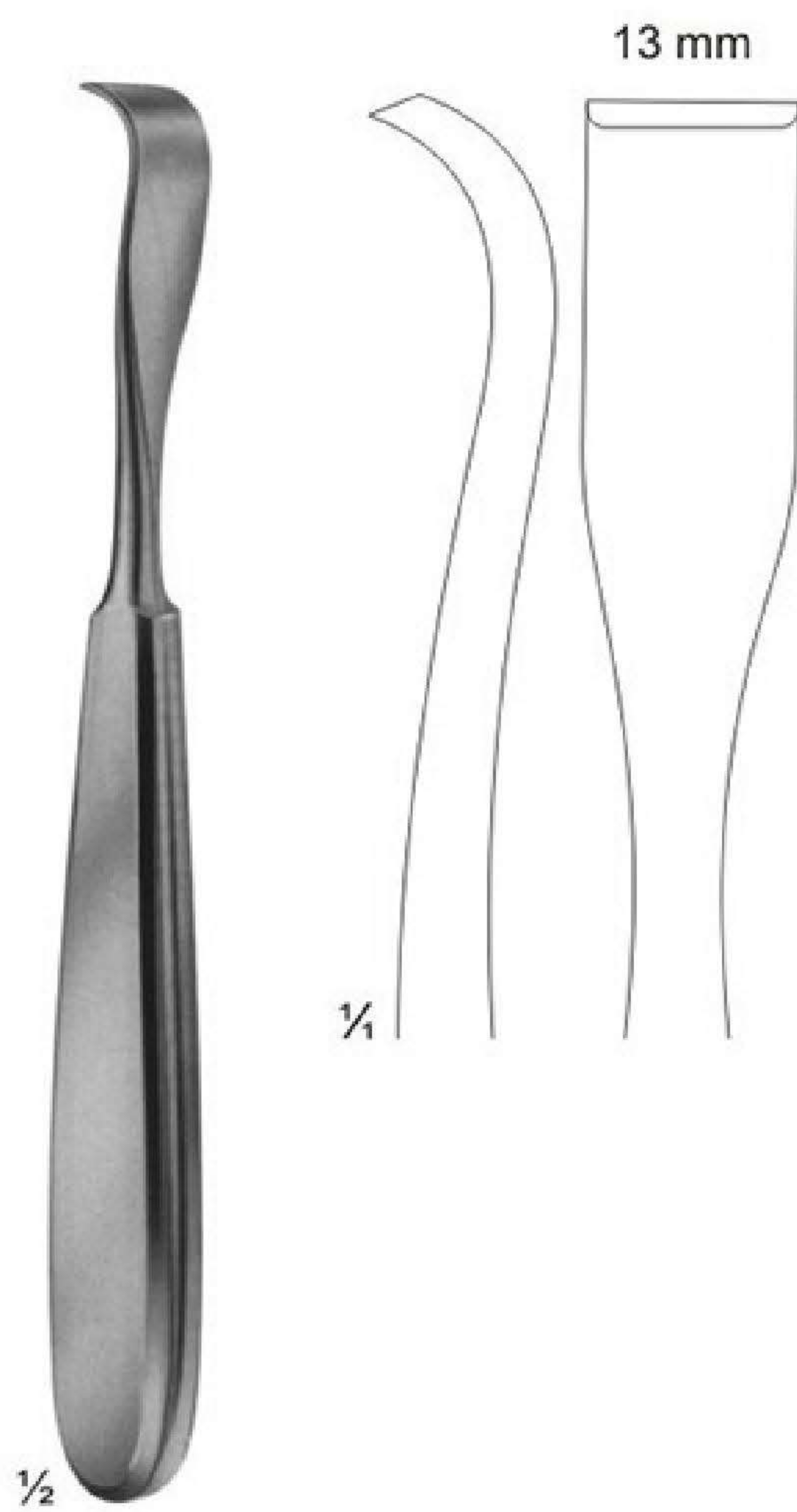

06-8132
SCHNEIDER
 175 mm

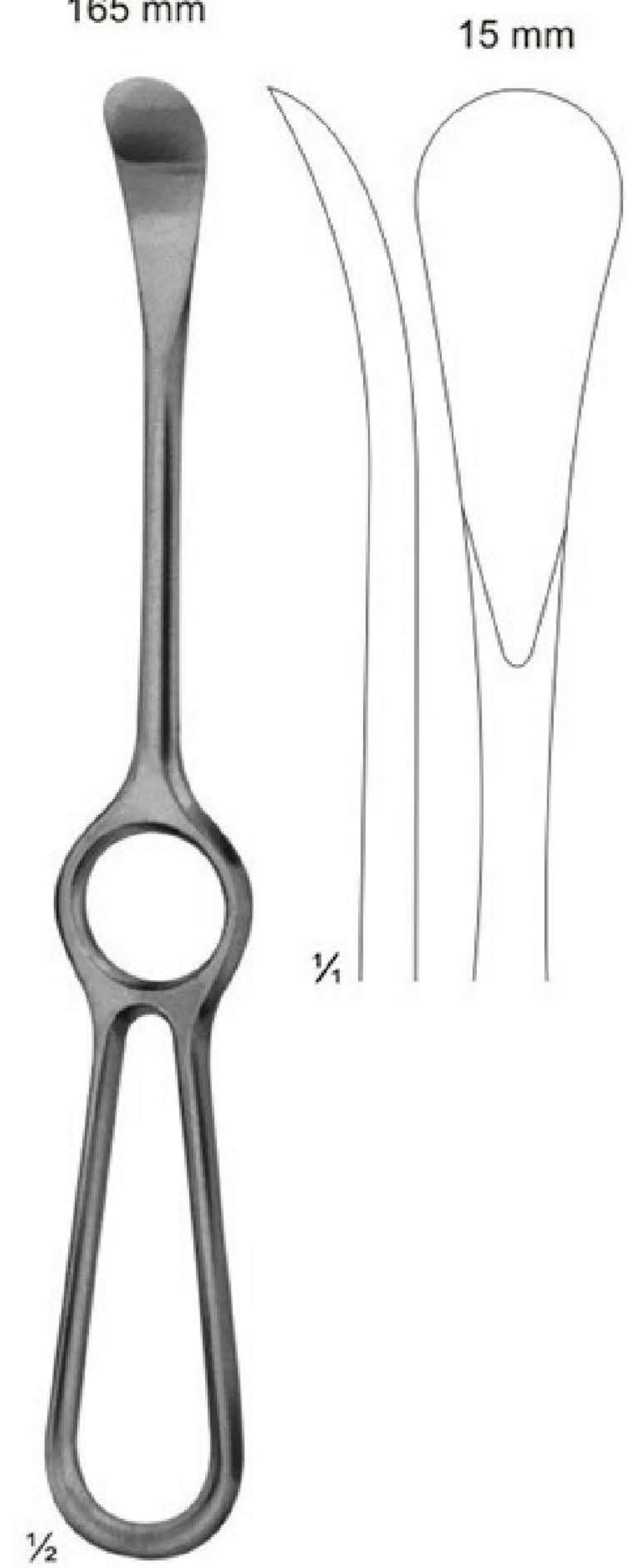

06-8133
SEDILLOT
 215 mm

Raspatories

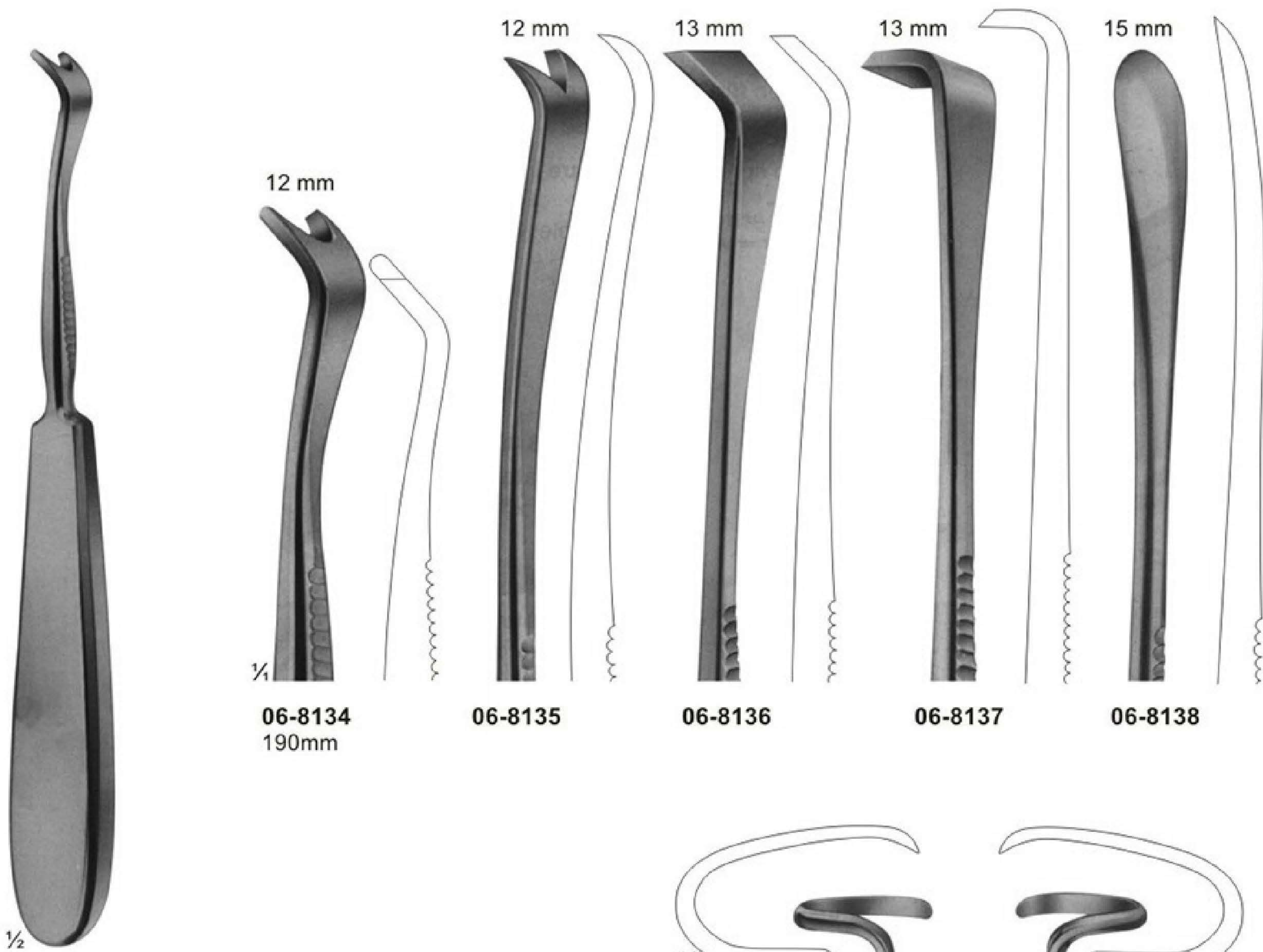

06-8134 - 06-8138
SEMB
230 mm



06-8143

06-8144

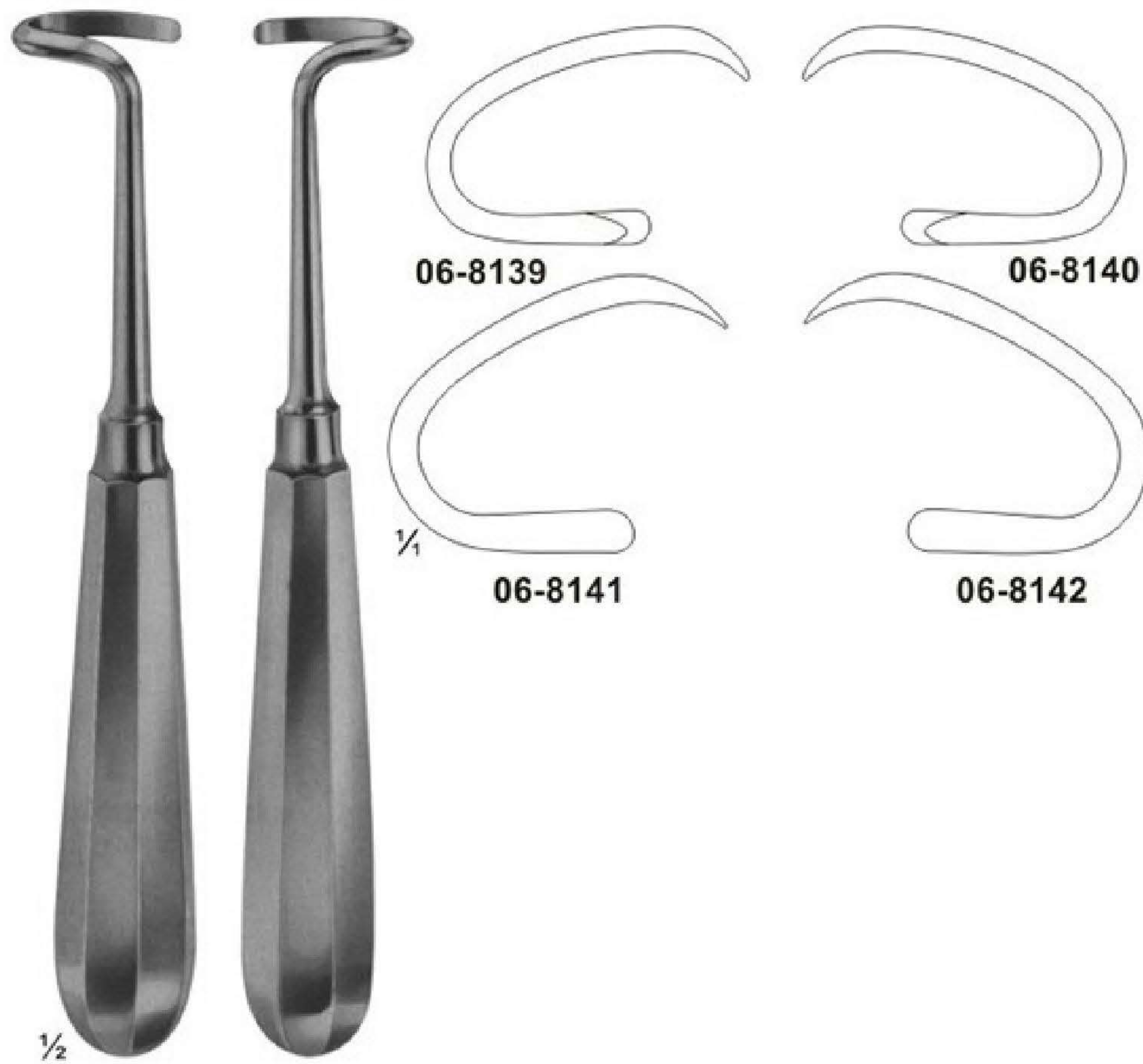

06-8139 - 06-8140
DOYEN for children
06-8141 - 06-8142
for adults 175 mm

06-8143 - 06-8144
DOYEN
240 mm

Raspatories with HARTPRESS-handle

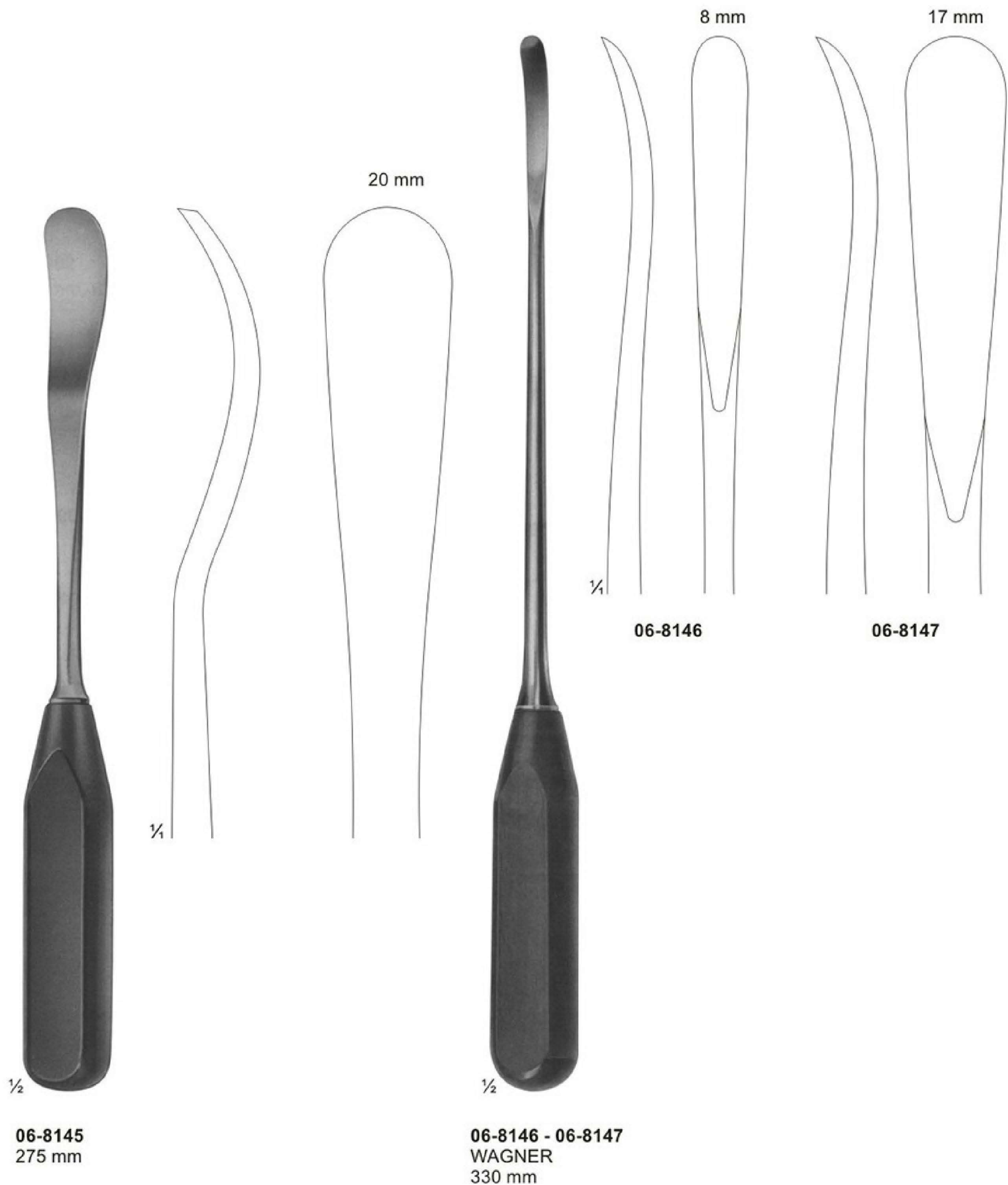

Bone File and Rasps

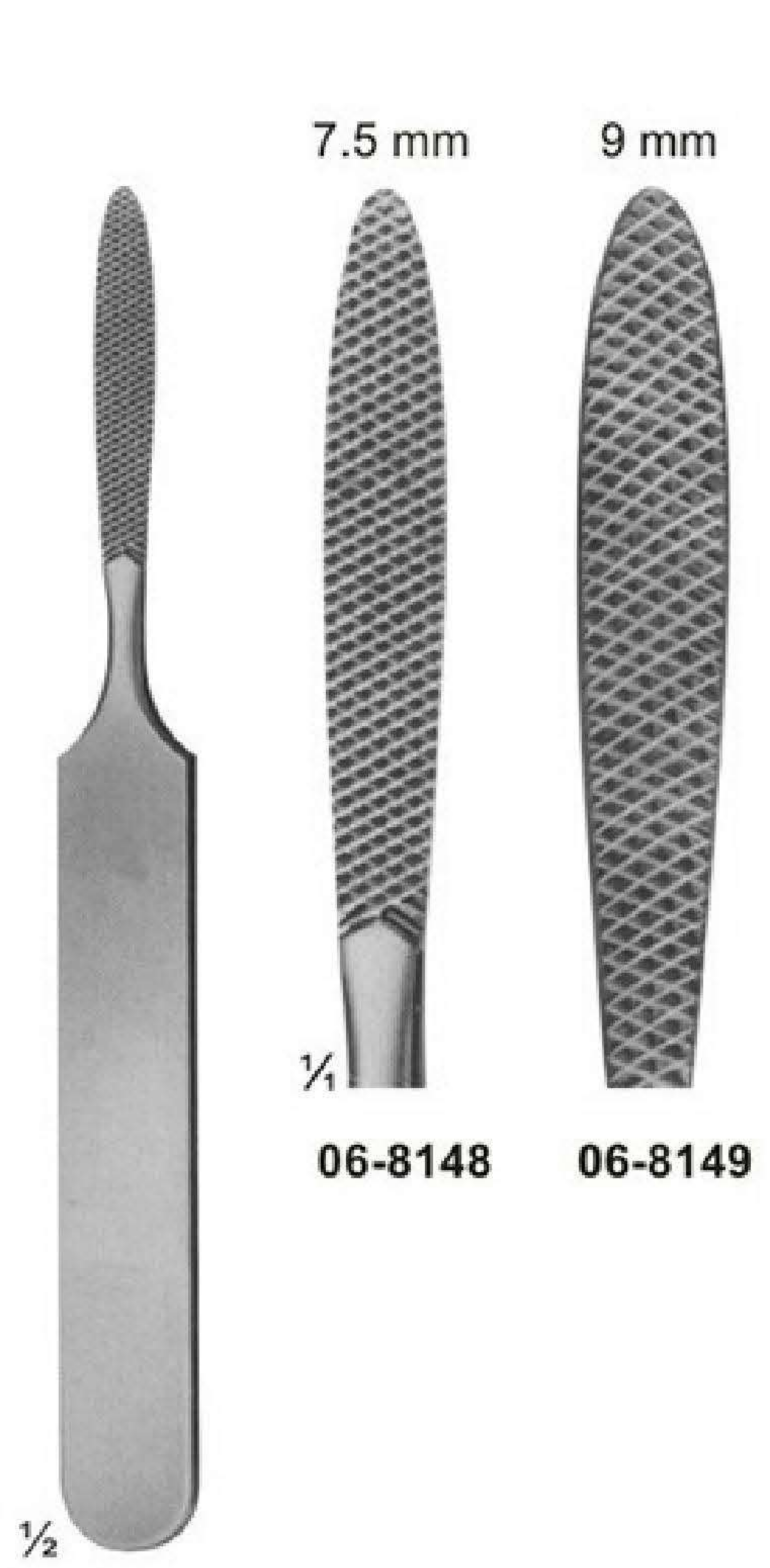

06-8148
 JOSEPH
 fine, chequered

06-8149
 coarse, chequered
 165 mm



06-8152
 MALTZ
 down stroke
 180 mm

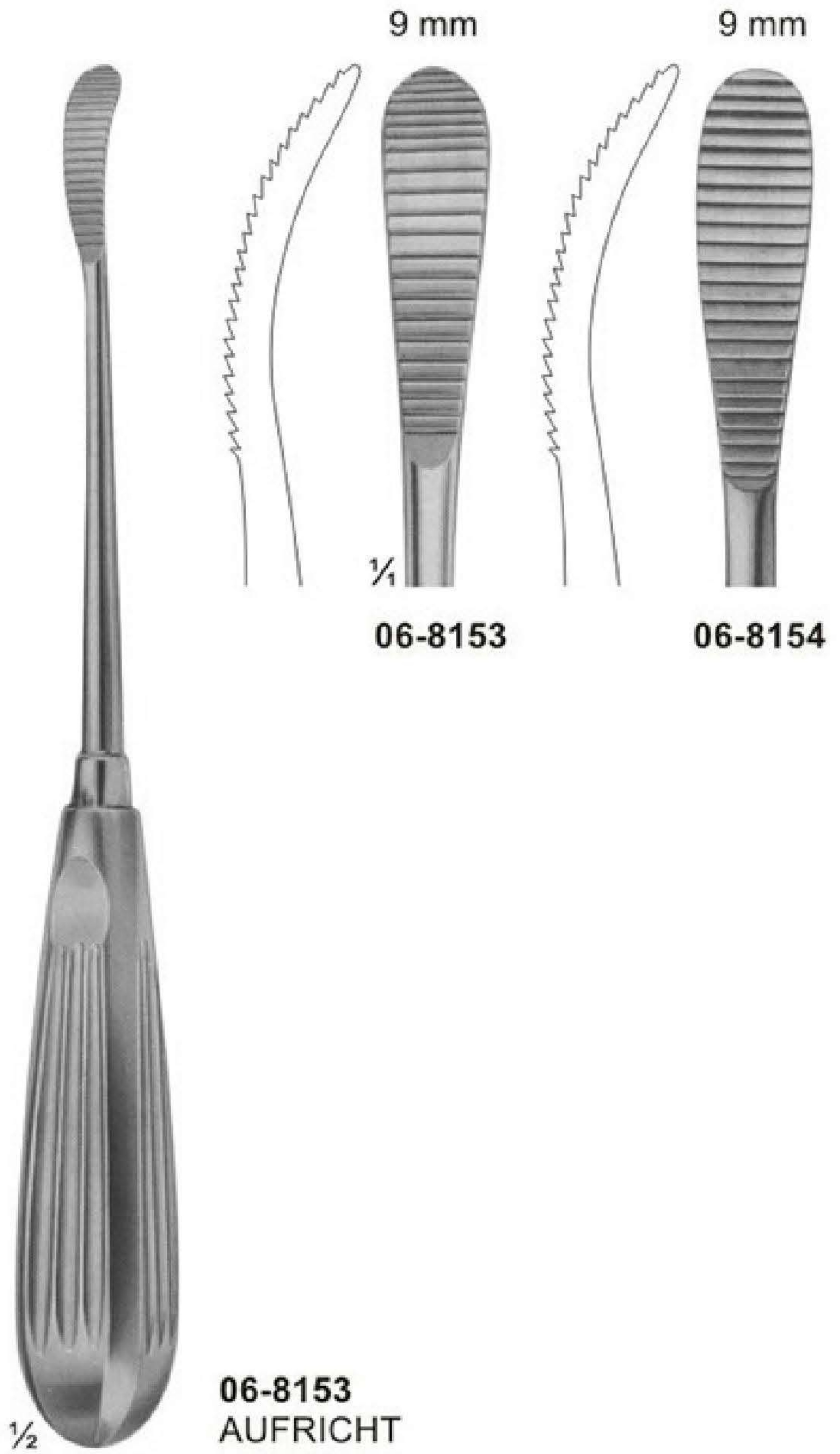

06-8153
 AUFRICHT
 up stroke
06-8154
 down stroke
 220 mm

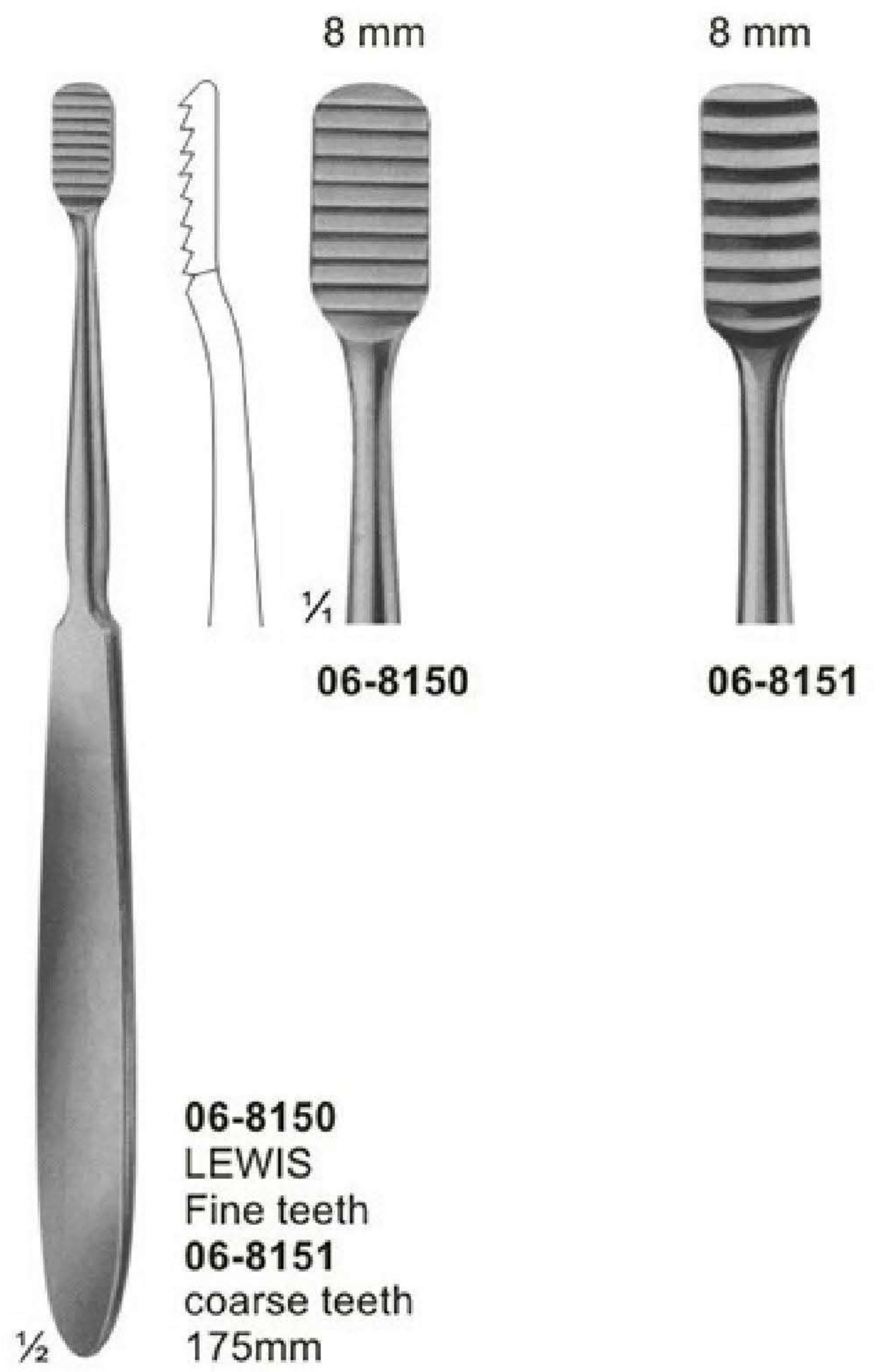

06-8150
 LEWIS
 Fine teeth
06-8151
 coarse teeth
 175mm

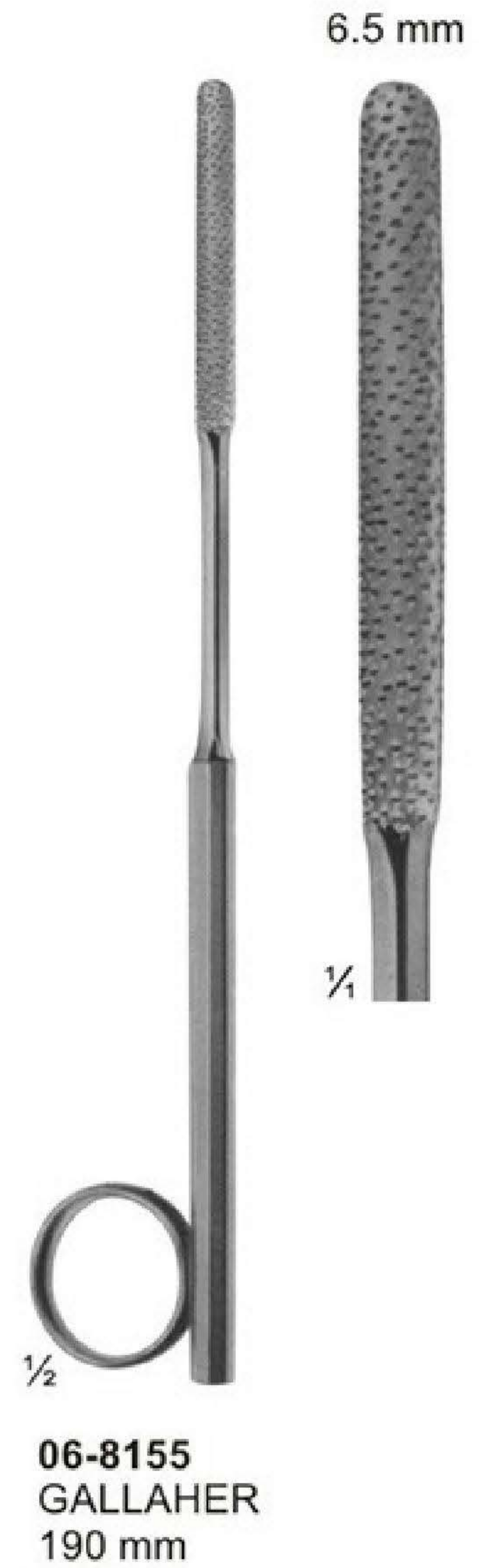

06-8155
 GALLAHER
 190 mm

Bone File and Rasps, Durogrip Rasps

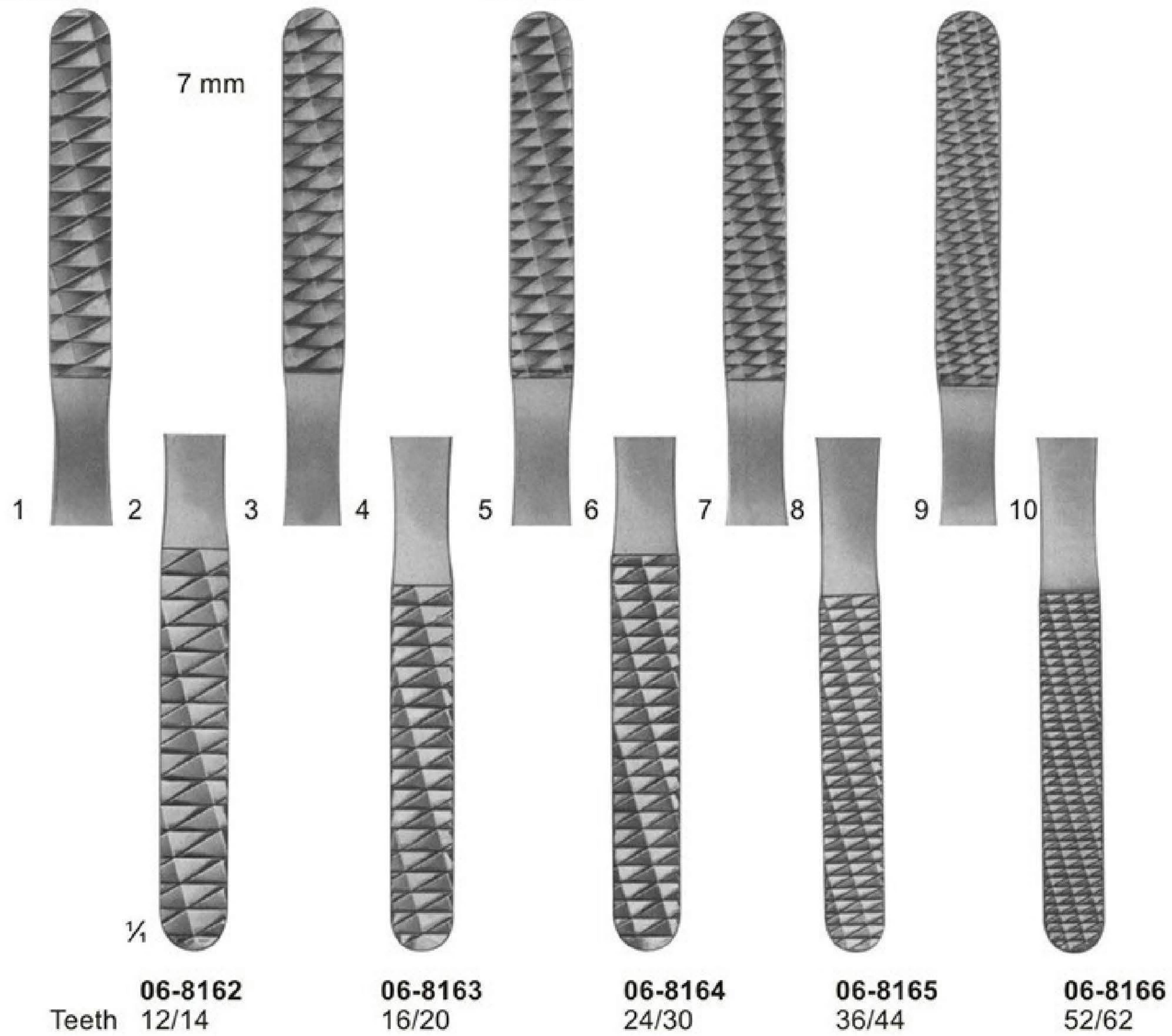
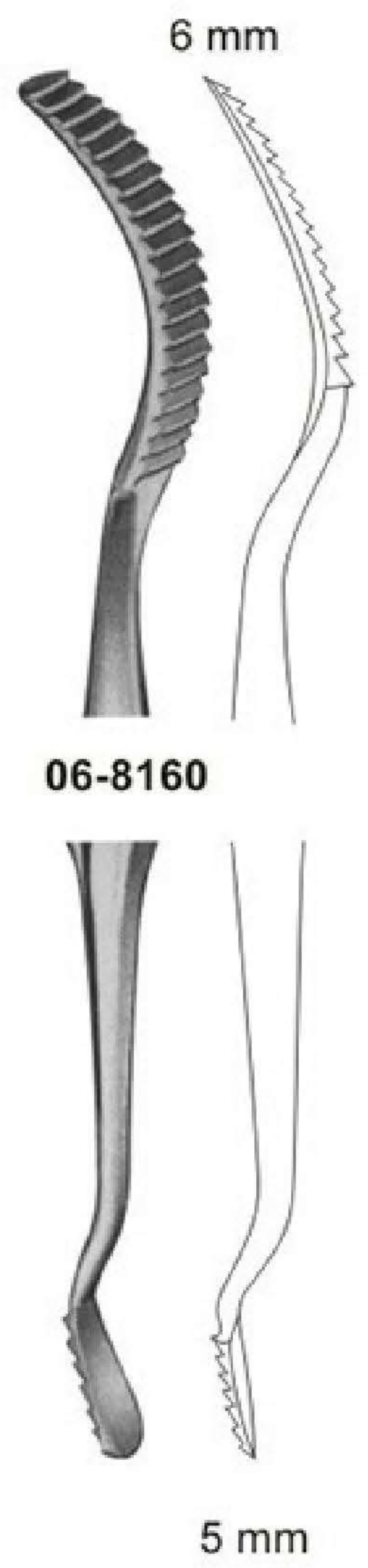
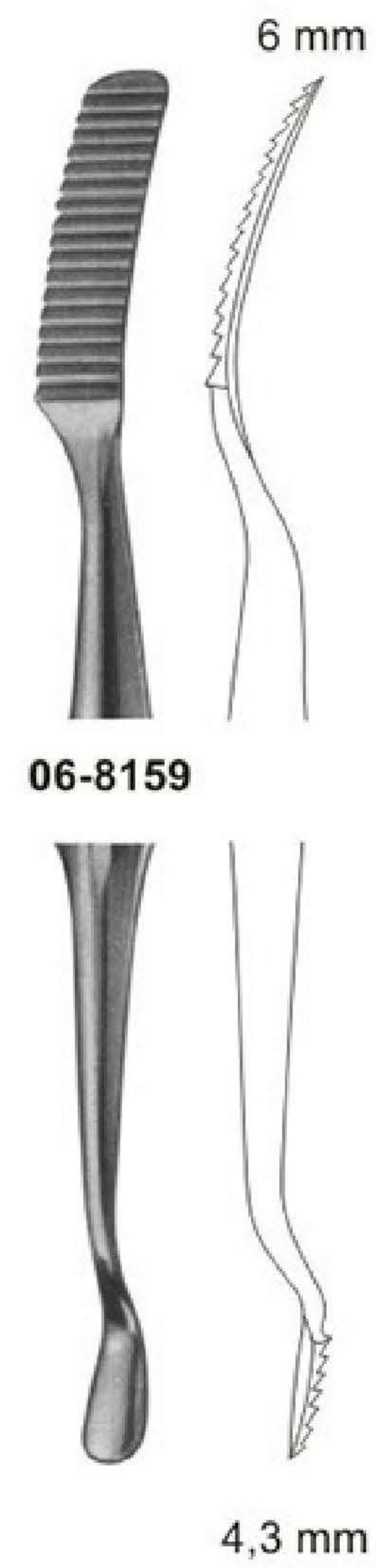
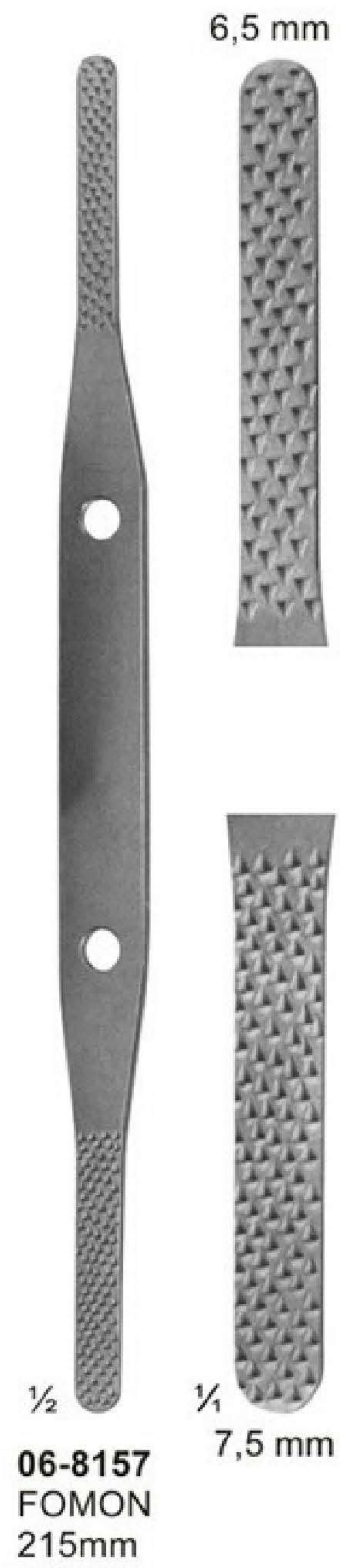
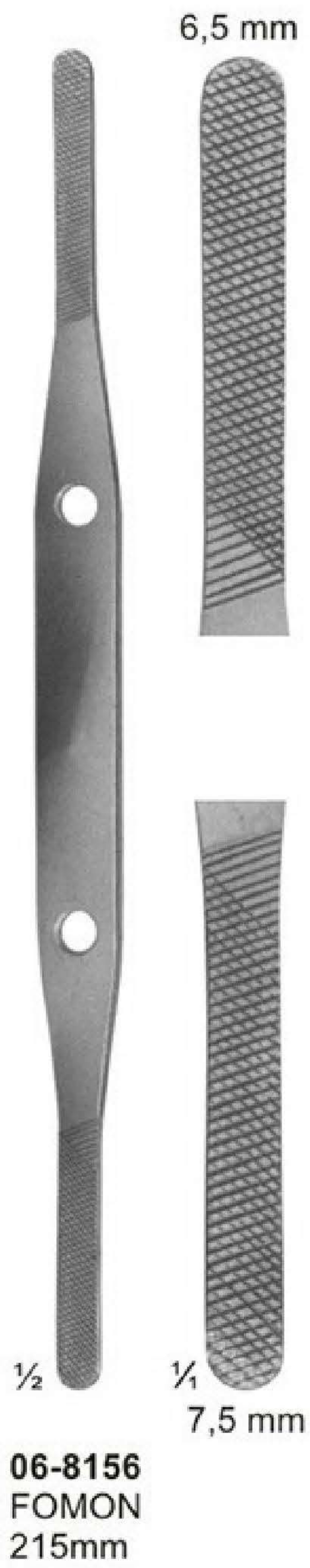

Bone File and Rasps

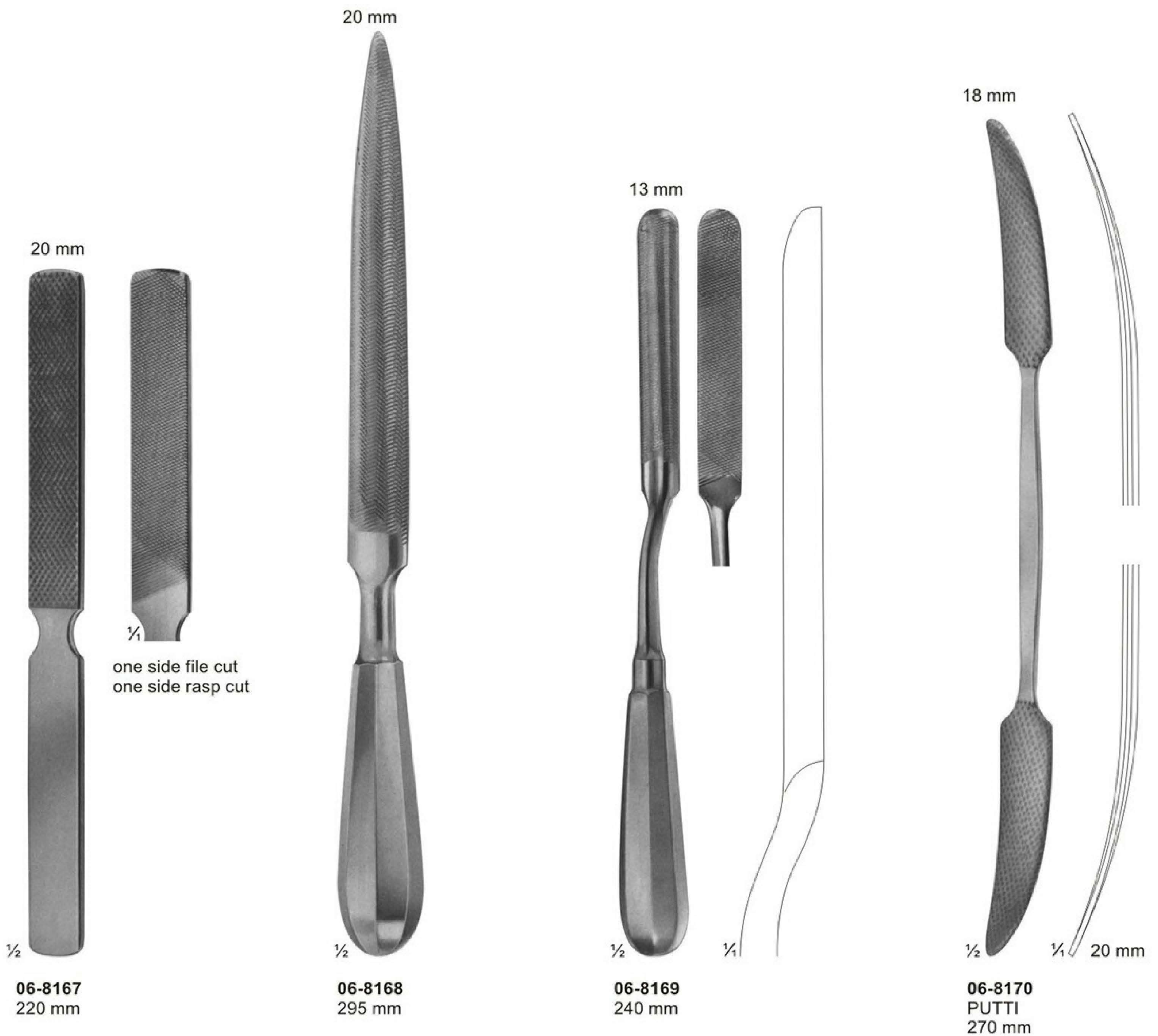

Bone Currettes

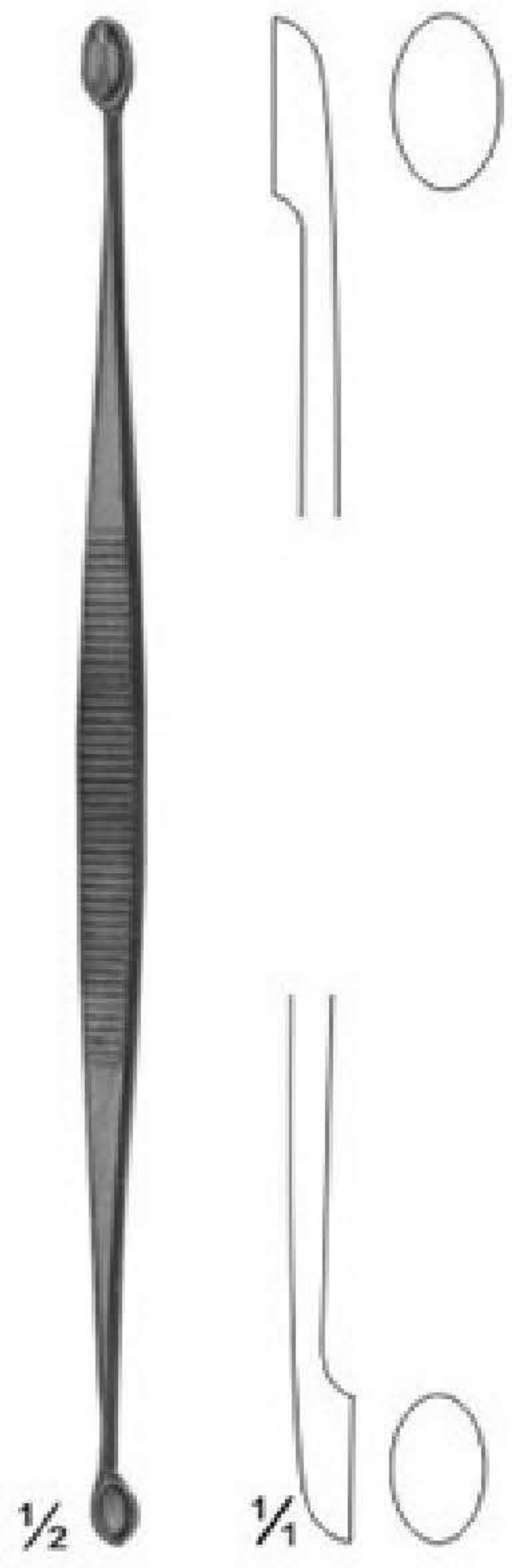

06-8171
JACOBSON
 140 mm

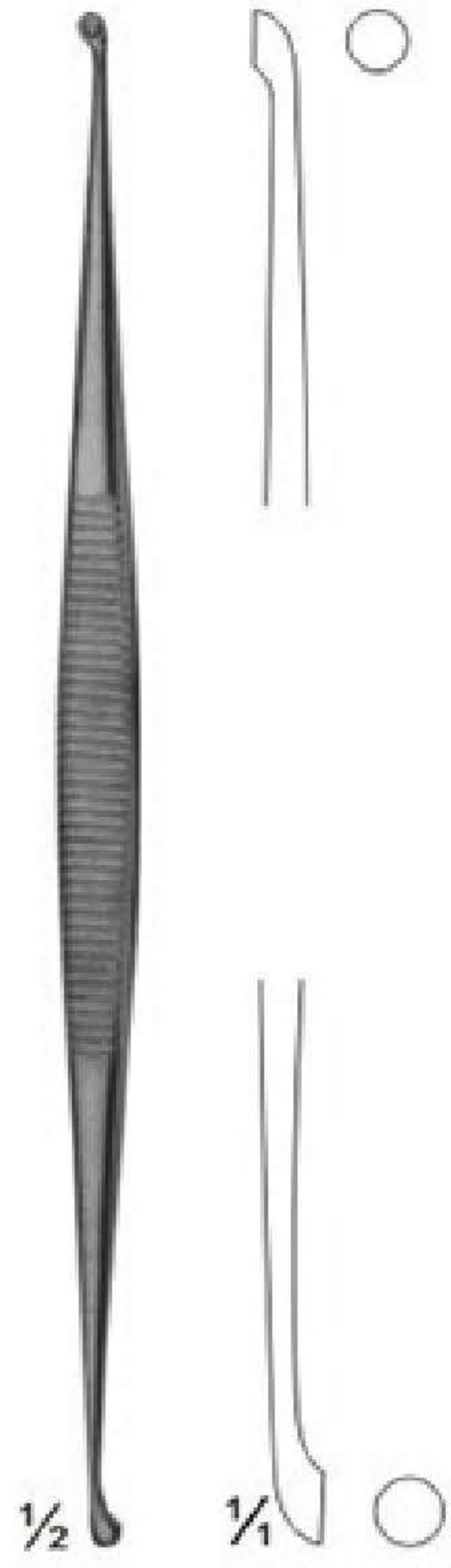

06-8172
MARTINI
 140 mm

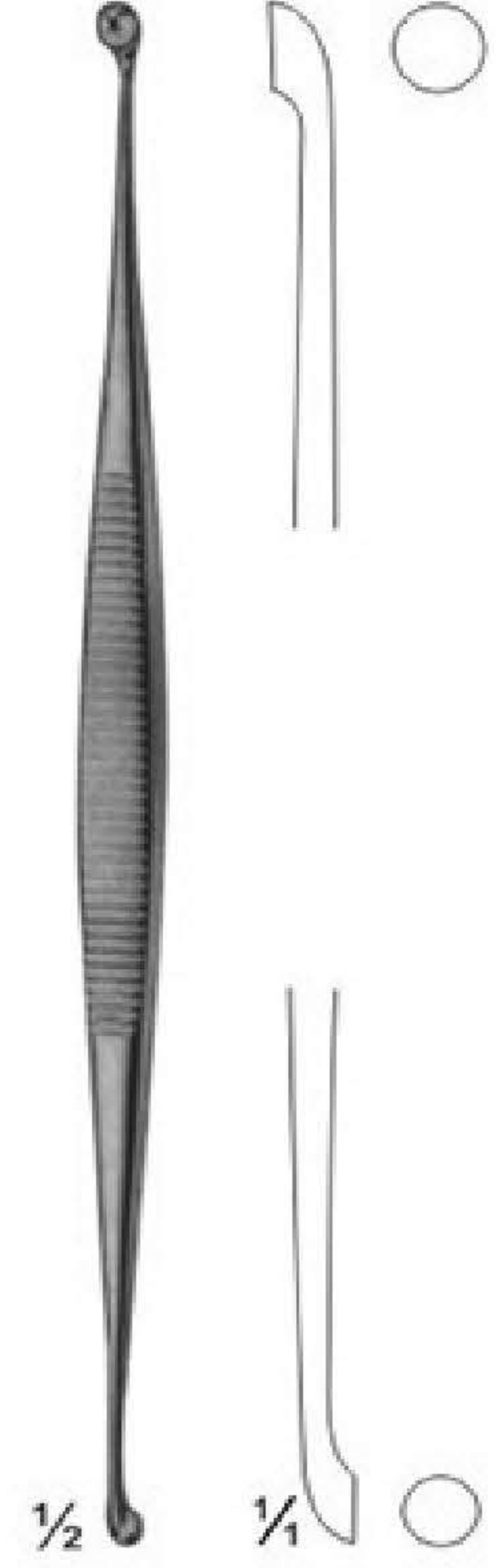

06-8173
MARTINI
 140 mm



06-8174
WILLIGER
 145 mm

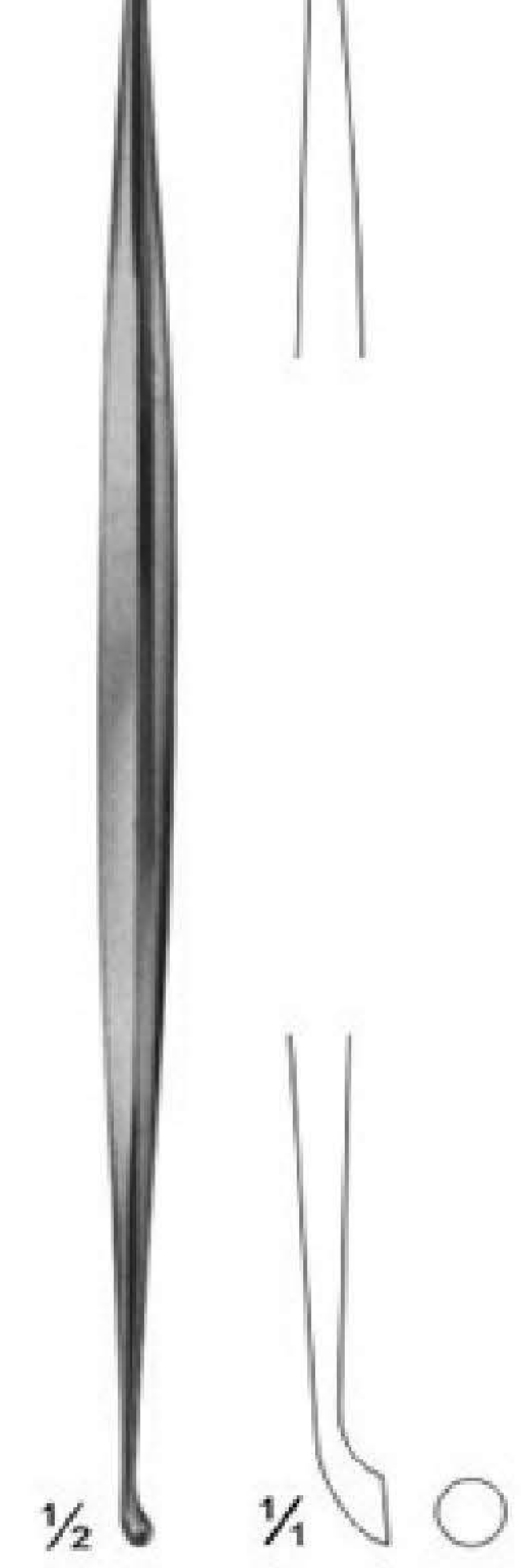

06-8175
JANSEN
 160 mm



06-8176
BARTH
 180 mm

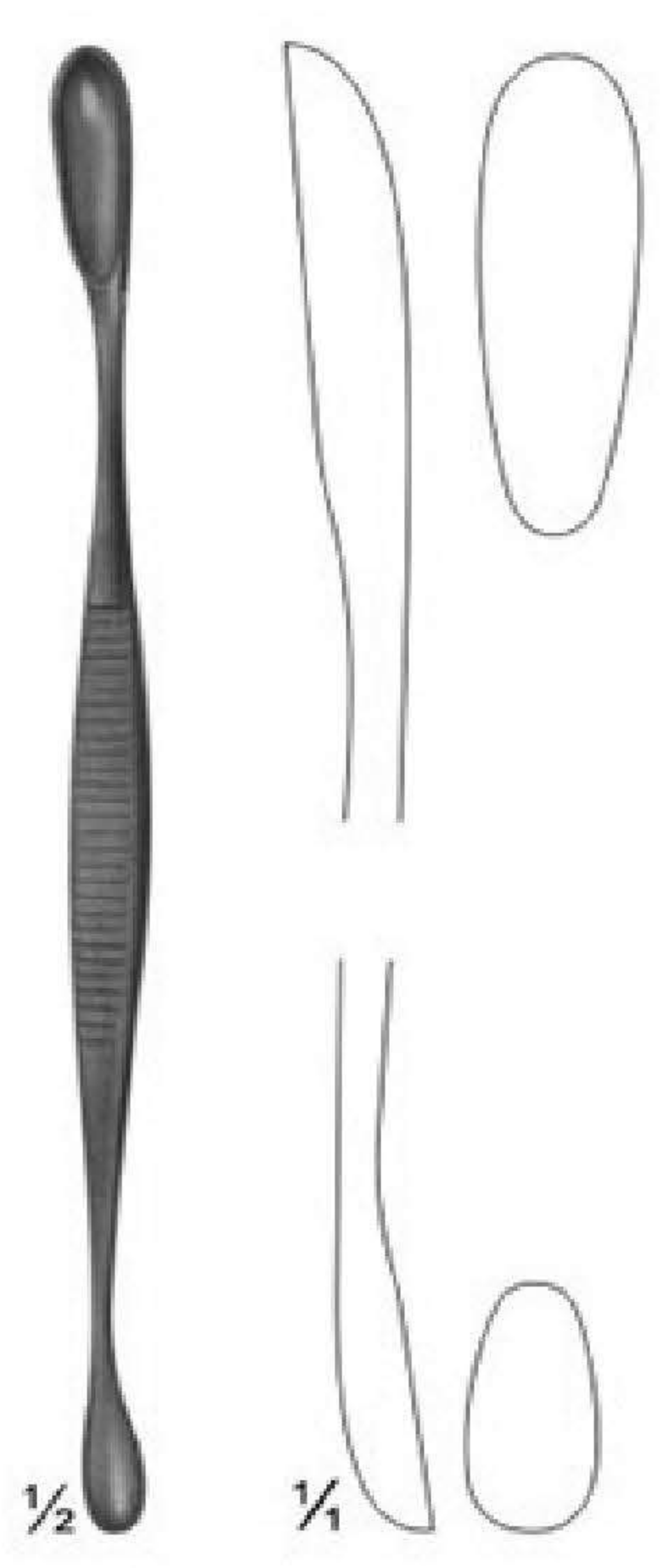

06-8177
VOLKMANN
 130 mm

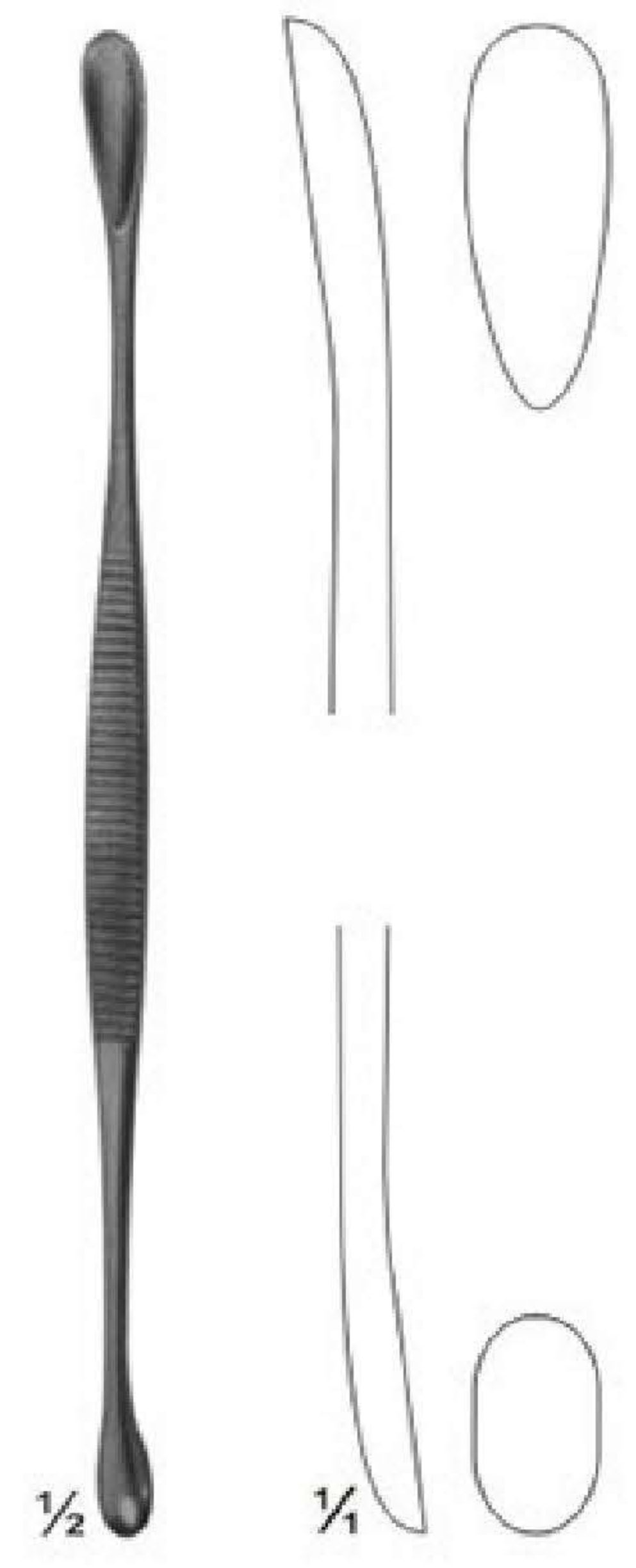

06-8178
VOLKMANN
 145 mm

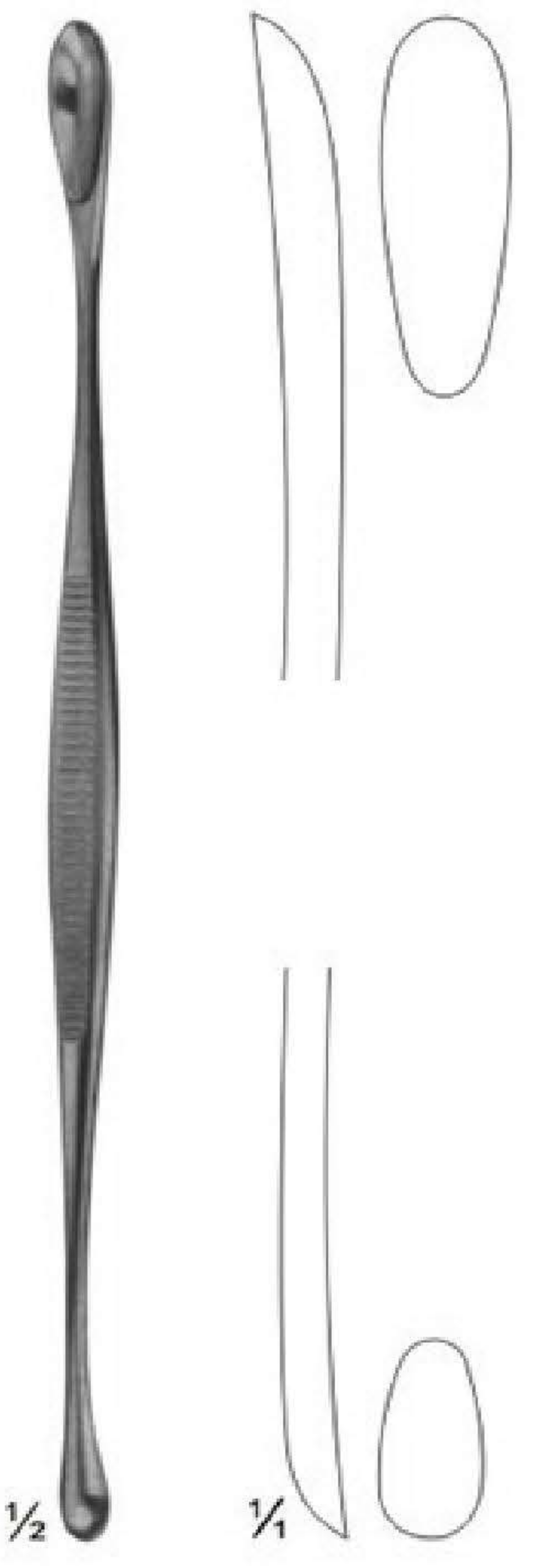

06-8179
VOLKMANN
 170 mm

Bone Currettes

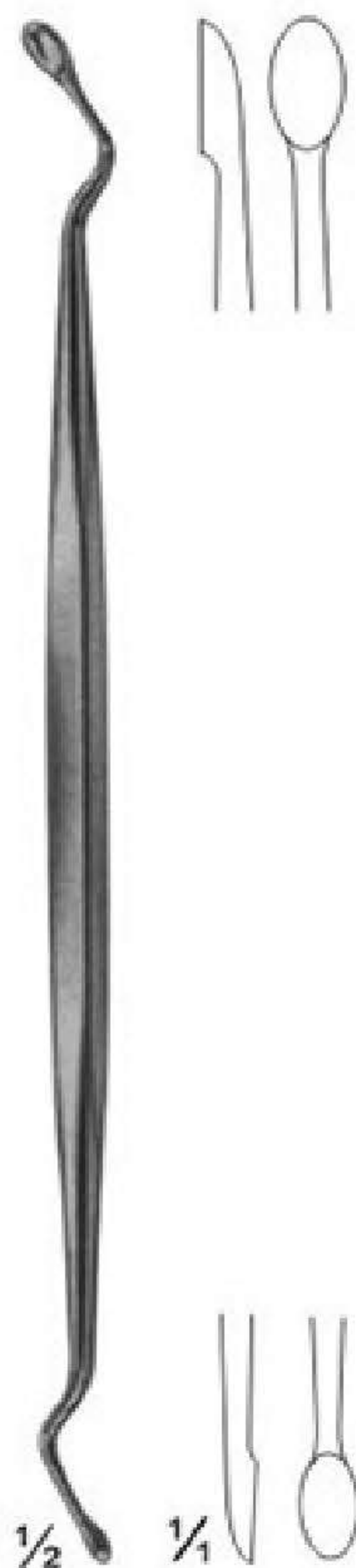

06-8180
JANSEN
160 mm

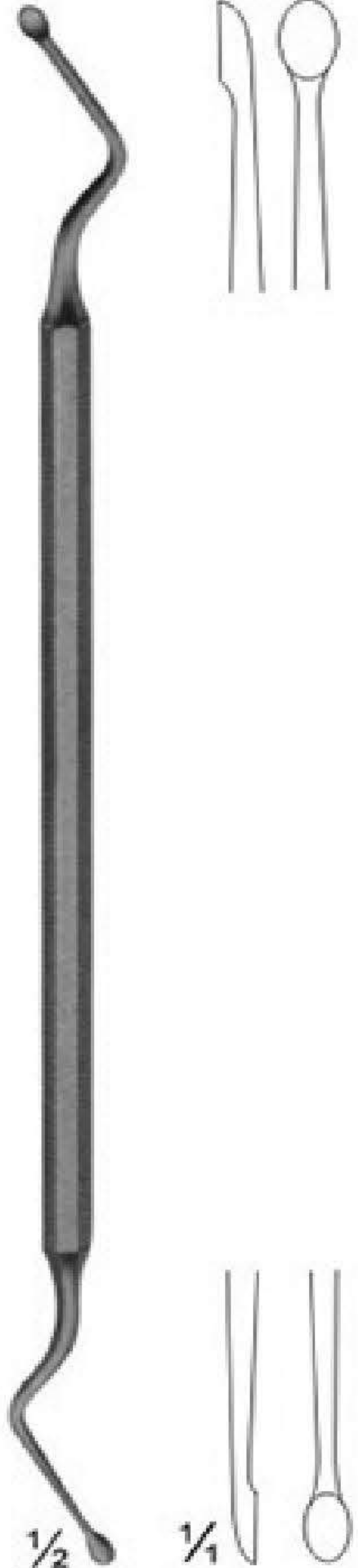

06-8181
HEMINGWAY
170 mm

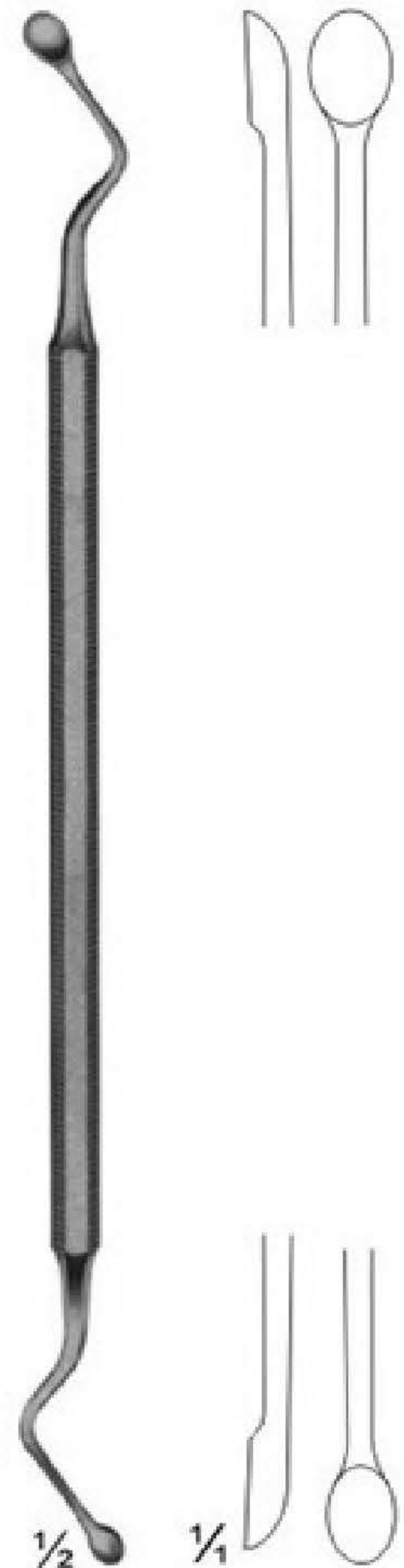

06-8182
HEMINGWAY
175 mm

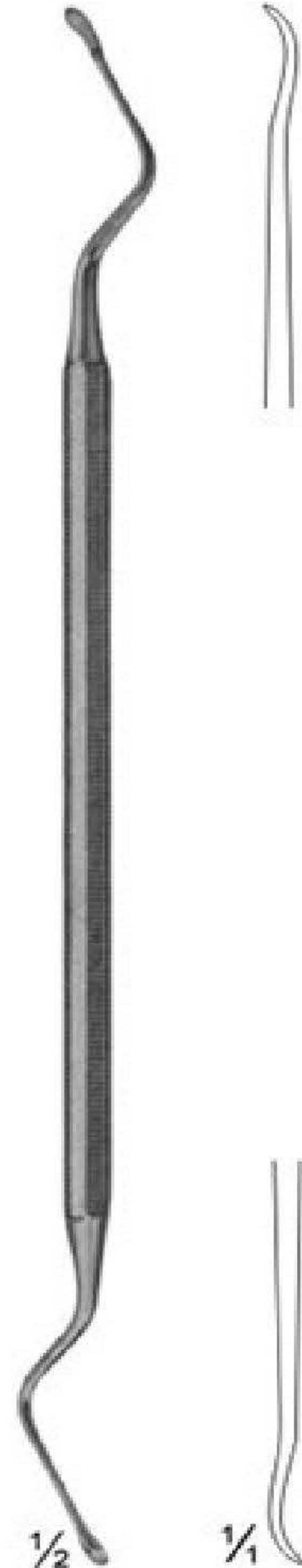

06-8183
LUCAS
180 mm

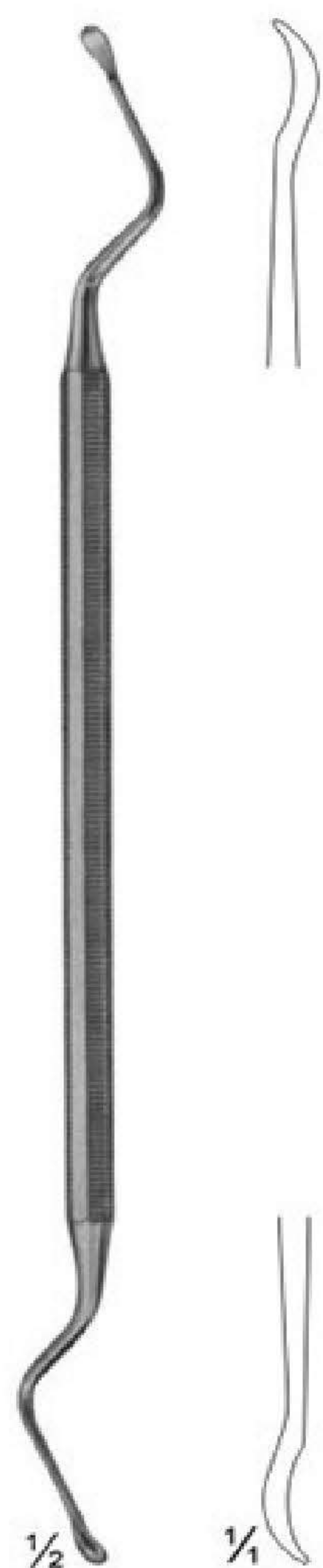

06-8184
LUCAS
185 mm



06-8185 - 06-8187
KERPEL
145 mm

06-8186 - 06-8188
KERPEL
145 mm

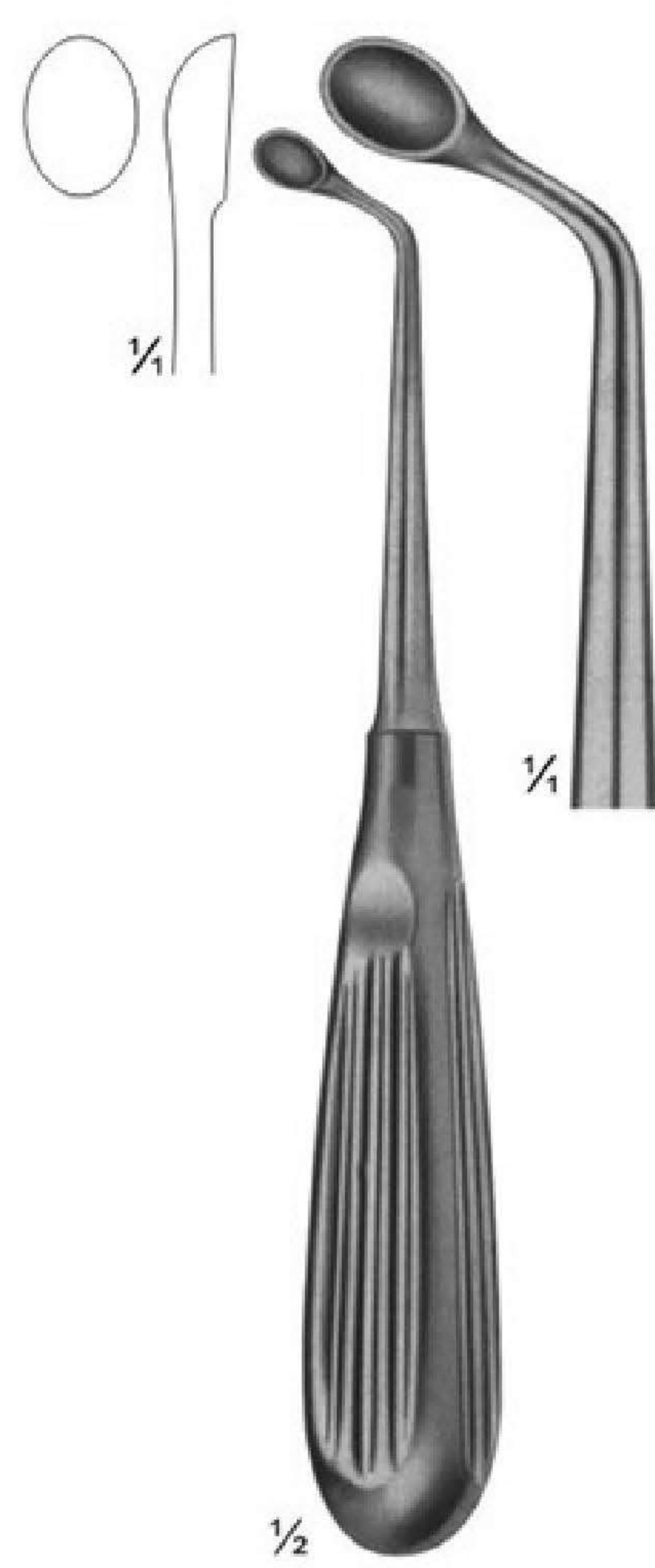

06-8189
UFFENORDE
170 mm



06-8190
UFFENORDE
170 mm

Bone Currettes



½



06-8191
3 mm
Fig: 000

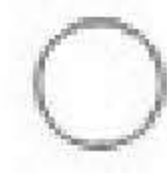

06-8192
4 mm
00

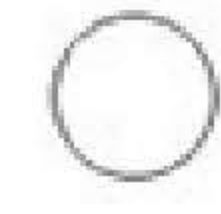

06-8193
5 mm
0



06-8194
6 mm
Fig: 1



06-8195
8 mm
2



06-8196
10 mm
3



06-8197
12 mm
4

06-8191 - 06-8197
BRUNS
165 mm

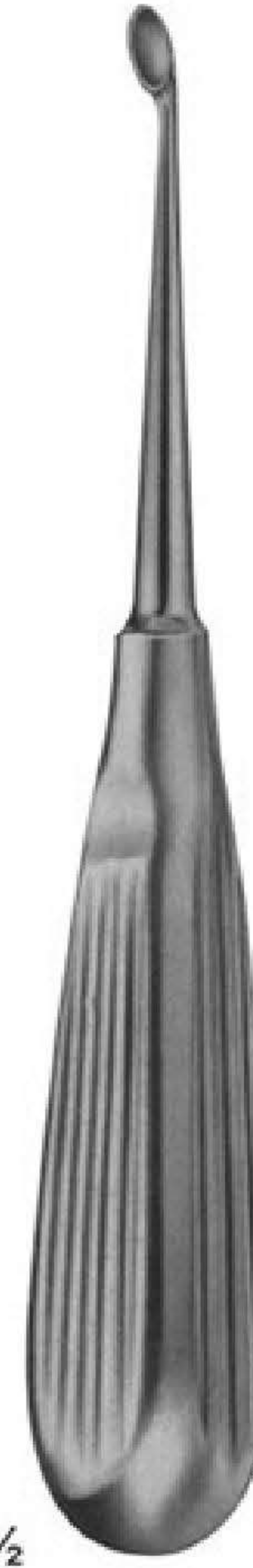

½



06-8198
2,5 mm
Fig: 000



06-8199
3,4 mm
00



06-8200
4,2 mm
0



06-8201
5,2 mm
Fig: 1



06-8202
6,3 mm
2



06-8203
7,4 mm
3

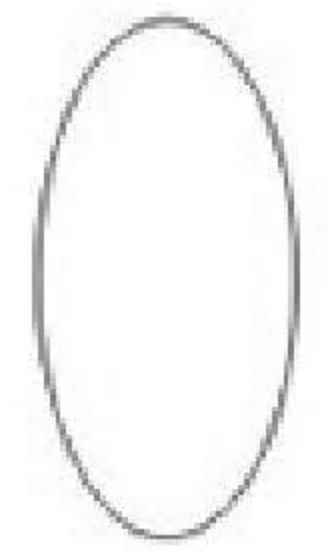

06-8204
8 mm
4

06-8198 - 06-8204
SCHEDE
170 mm

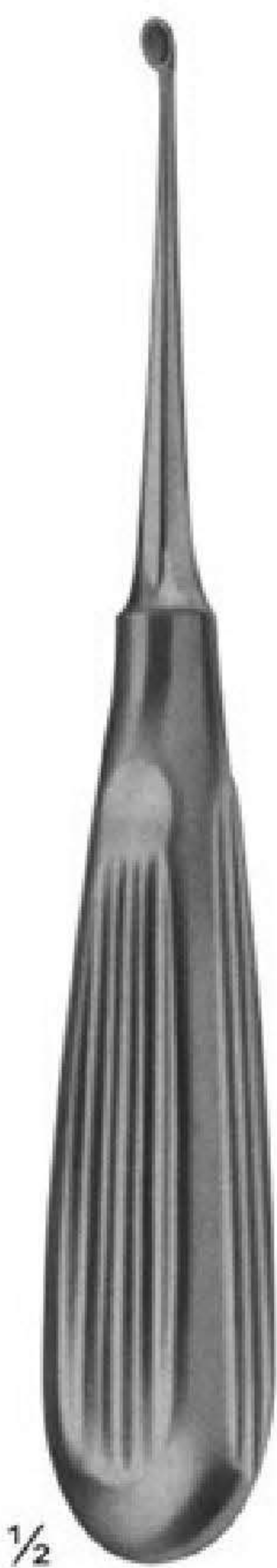

½



06-8205
2,8 mm
Fig: 0000

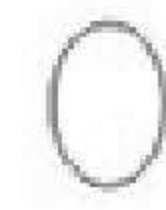

06-8206
3,6 mm
000



06-8207
4,4 mm
00



06-8208
5,2 mm
0



06-8209
6,8 mm
1



06-8210
8,5 mm
Fig: 2



06-8211
10 mm
3



06-8212
11,5 mm
4



06-8213
13 mm
5



06-8214
14,5 mm
6

06-8205 - 06-8214
VOLKMANN
170 mm



½



06-8215
3,4 mm
Fig: 00



06-8216
5,2 mm
1

06-8215 - 06-8216
WILLIGER
170 mm

Bone Curettes



06-8217
1,8 mm

06-8218
2,0 mm

06-8219
2,4 mm

06-8220
2,6 mm

06-8221
2,8 mm

1/2

06-8217 - 06-8221
LEMPERT
215 mm

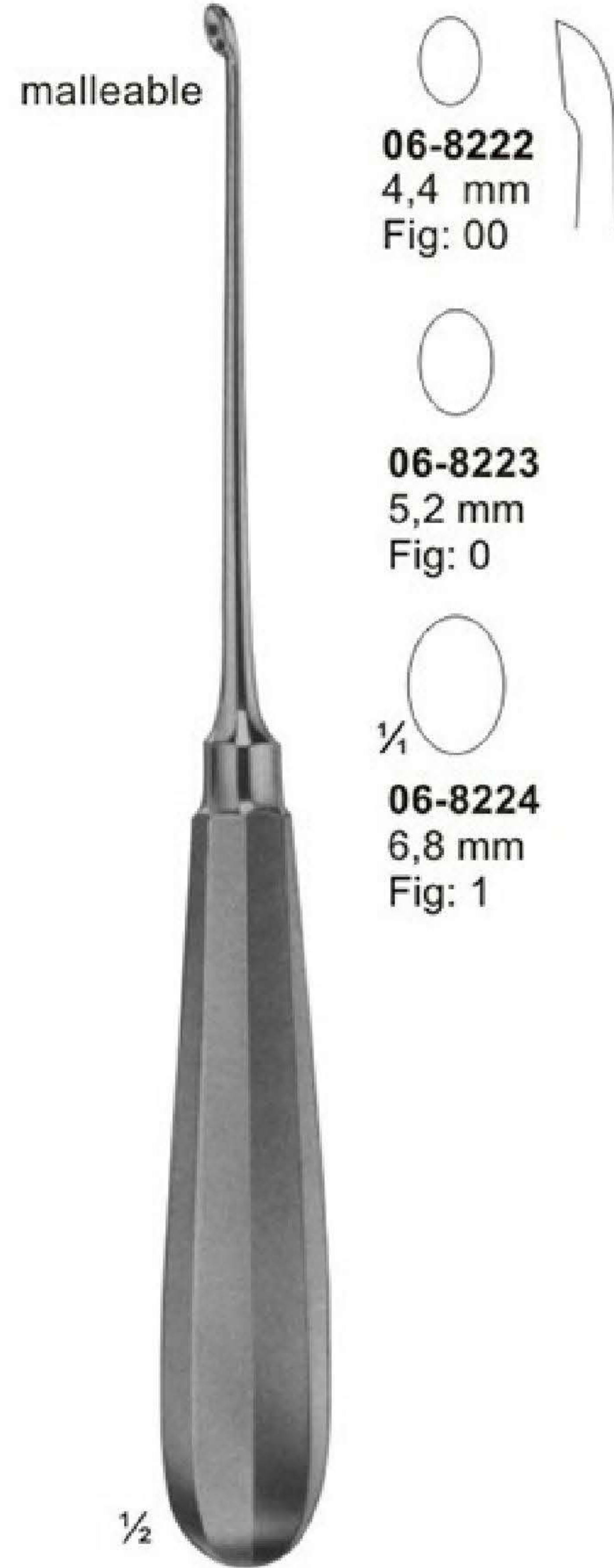

malleable

06-8222
4,4 mm
Fig: 00

06-8223
5,2 mm
Fig: 0

06-8224
6,8 mm
Fig: 1

1/2

06-8222 - 06-8224
HALLE
215 mm



06-8225
2,8 mm
Fig: 0000

06-8226
3,6 mm
Fig: 000

06-8227
4,4 mm
Fig: 00

06-8228
5,2 mm
Fig: 0

1/2

06-8225 - 06-8228
DAUBENSPECK
200 mm

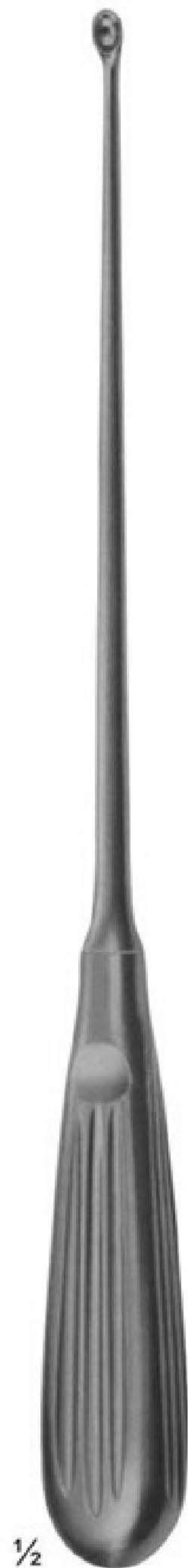

06-8229
3,6 mm
Fig: 000

06-8230
4,4 mm
Fig: 00

06-8231
5,2 mm
Fig: 0

06-8232
6,8 mm
Fig: 1

1/2

06-8229 - 06-8232
250 mm



06-8233
3,6 mm
Fig: 000

06-8234
4,4 mm
Fig: 00

06-8235
5,2 mm
Fig: 0

06-8236
6,8 mm
Fig: 1

1/2

06-8233 - 06-8236
250 mm



06-8237
3 mm

06-8238
4 mm

06-8239
5 mm

1/2

06-8237 - 06-8239
BUSHE 250 mm

Bone Curettes



6 mm



1/2

06-8240
TESSIER
220 mm





06-8241
3,6 mm
Fig: 000

06-8242
4,4 mm
Fig: 00

06-8243
5,2 mm
Fig: 0

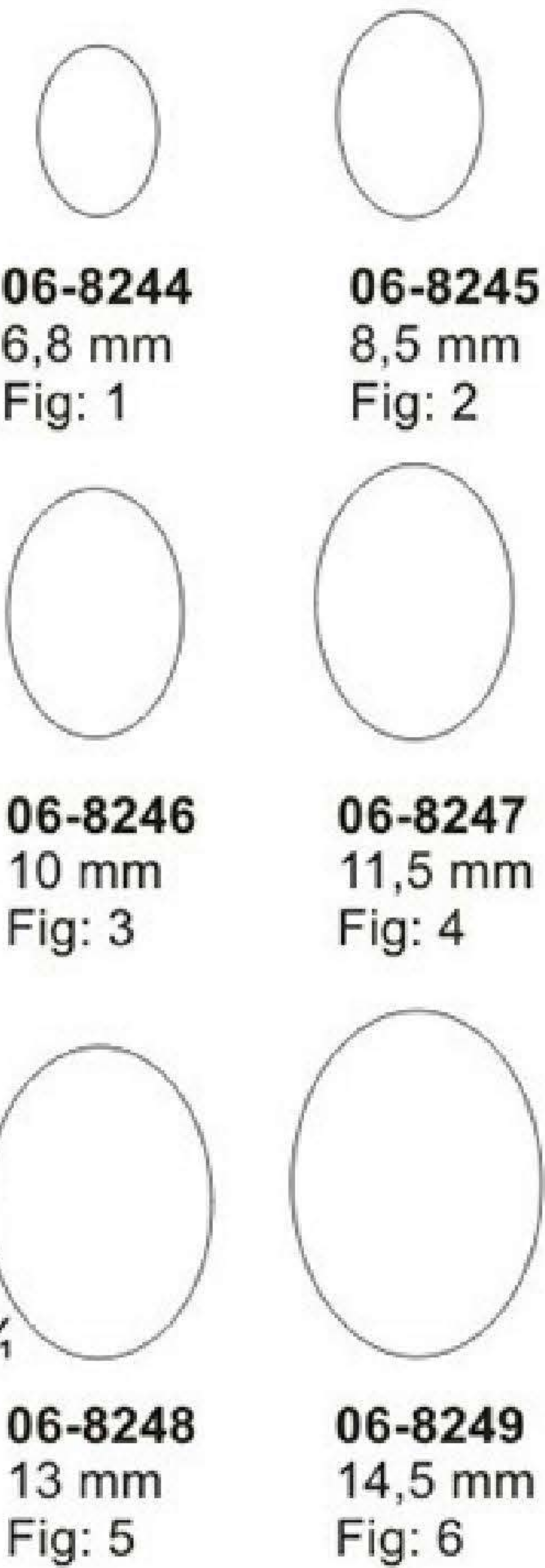
06-8241 - 06-8243
SIMON
235 mm

06-8244
6,8 mm
Fig: 1

06-8245
8,5 mm
Fig: 2

06-8246
10 mm
Fig: 3

06-8247
11,5 mm
Fig: 4

06-8248
13 mm
Fig: 5

06-8249
14,5 mm
Fig: 6

06-8244 - 06-8249
SIMON
240 mm



06-8250
3,6 mm
Fig: 000

06-8251
4,4 mm
Fig: 00

06-8252
5,2 mm
Fig: 0

06-8250 - 06-8252
CASPAR
220 mm



06-8253
3,6 mm
Fig: 000

06-8254
4,4 mm
Fig: 00

06-8255
5,2 mm
Fig: 0

06-8253 - 06-8255
CASPAR
220 mm



06-8256
4 mm

06-8257
5 mm

06-8258
6 mm

06-8256 - 06-8258
CASPAR
toothed
220 mm

Bone Currettes With Hartpress Handle

can be sterilized in a steam sterilizer upto 3 bar over pressure (143°C).

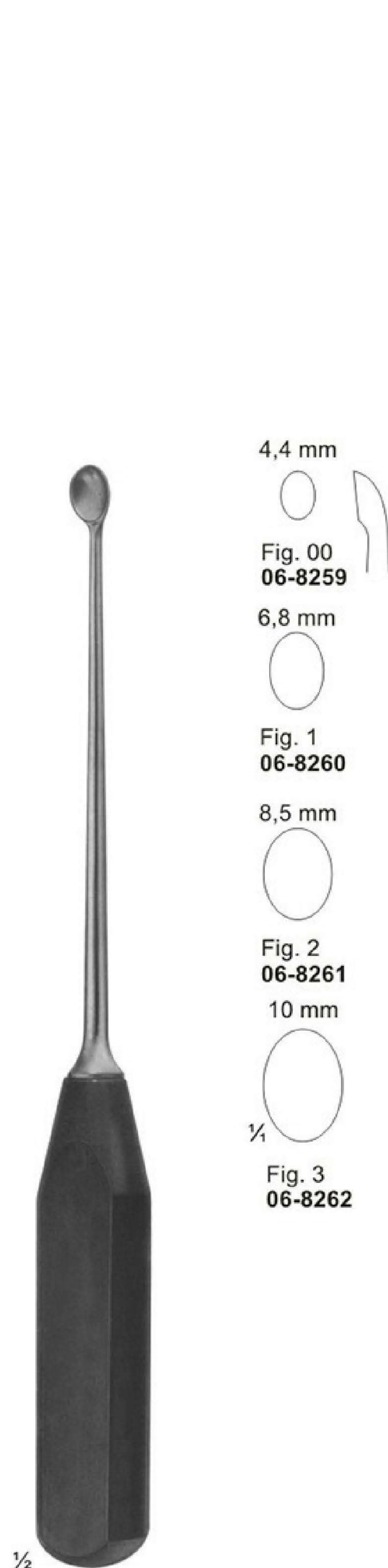

06-8259 - 06-8262
 270 mm

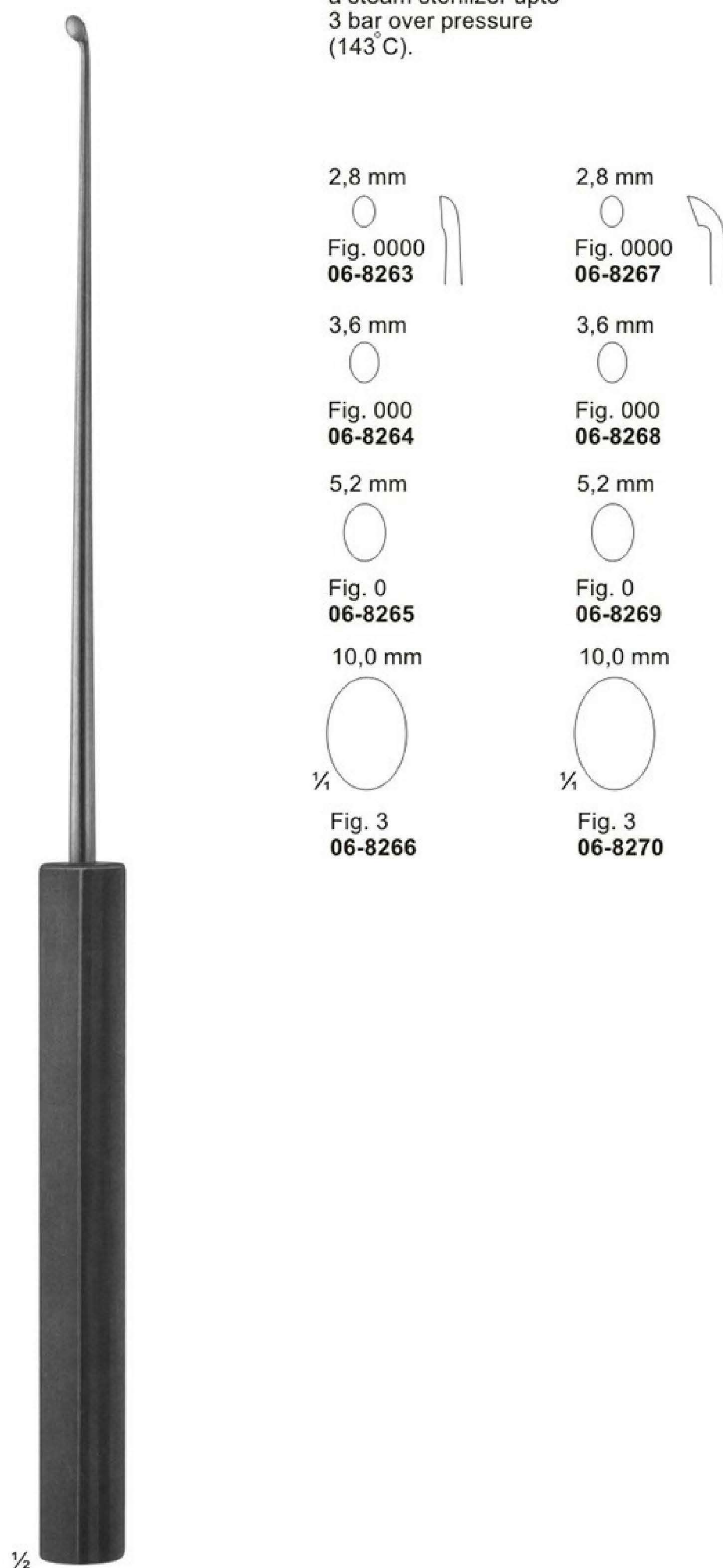

06-8263 - 06-8270
 SYPERT
 380 mm