

Biopsy Currettes

Malleable

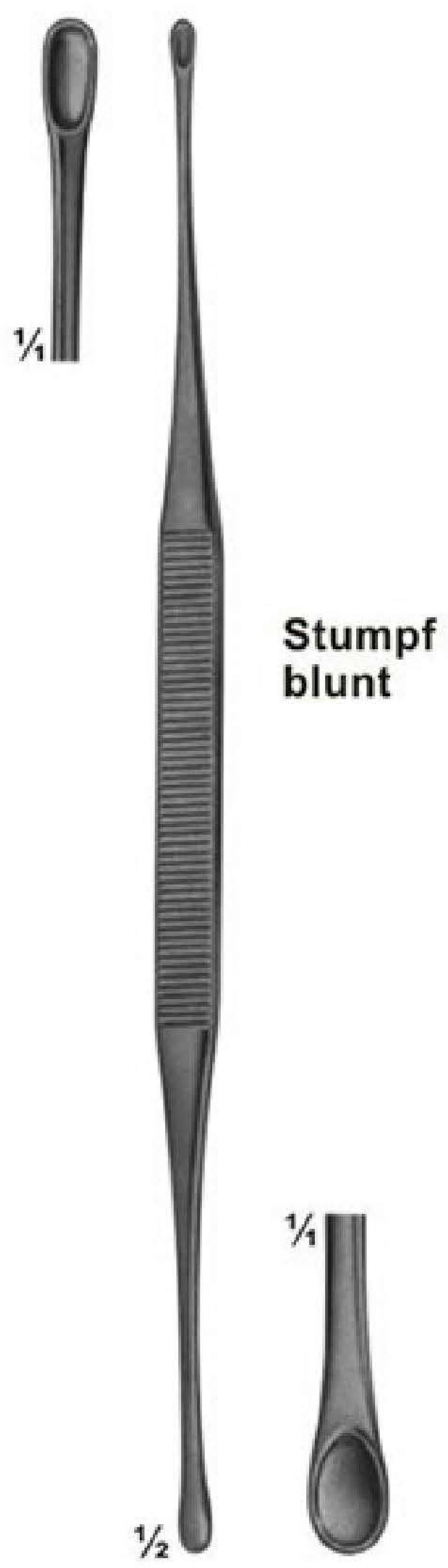

04-6265
 ASCH
 Uterine
 Secretion scoop
 200 mm

Malleable

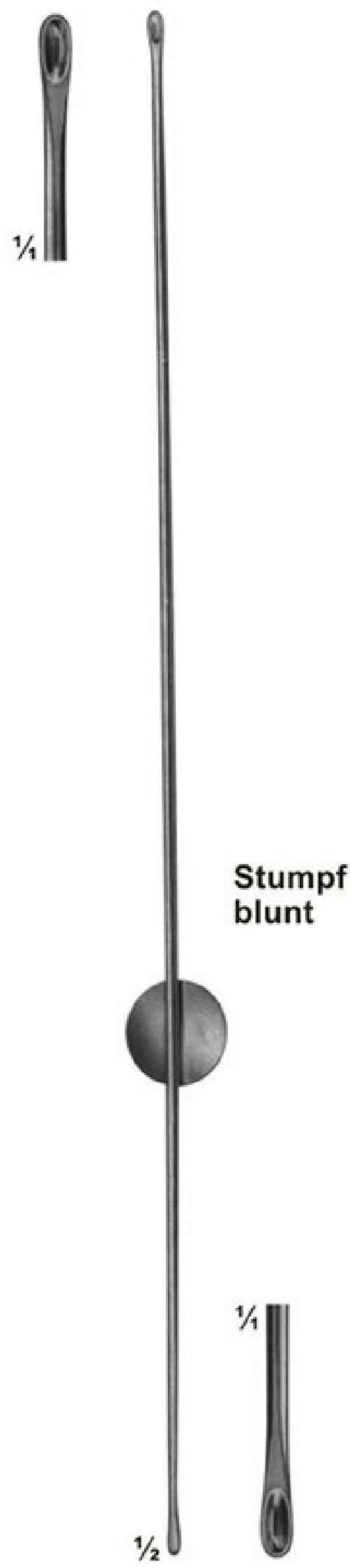

04-6266
 Uterine
 Secretion scoop
 270 mm

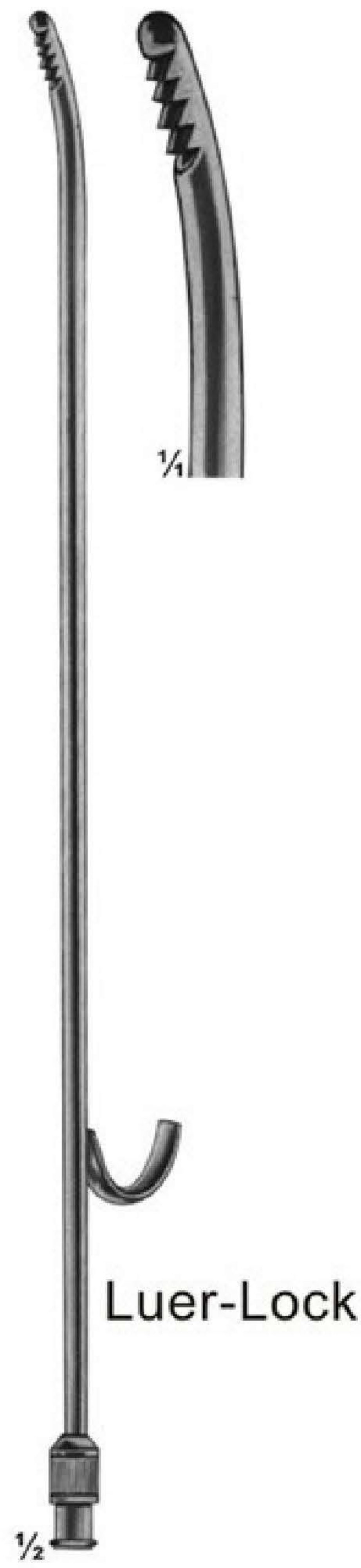

04-6267
 NOVAK-SCHOECKAERT
 Endometrial biopsy
 curette
 240 mm

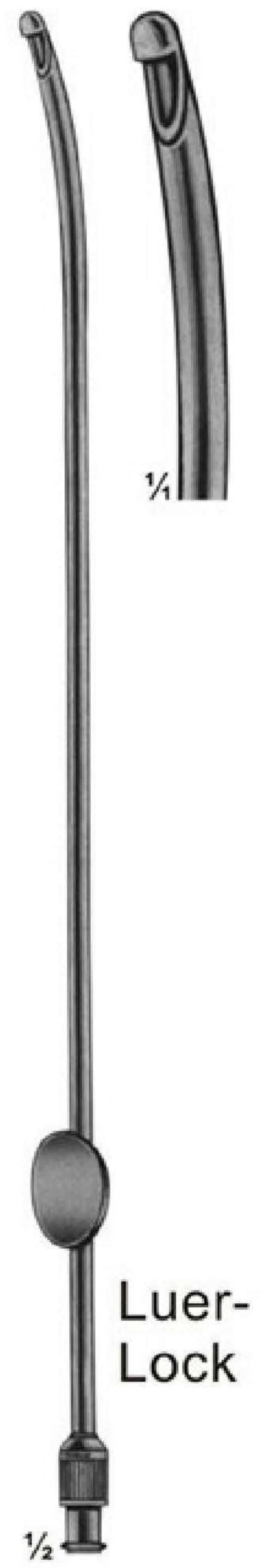

04-6268
 RANDALL
 Endometrial
 biopsy curette
 240 mm

Biopsy Forceps

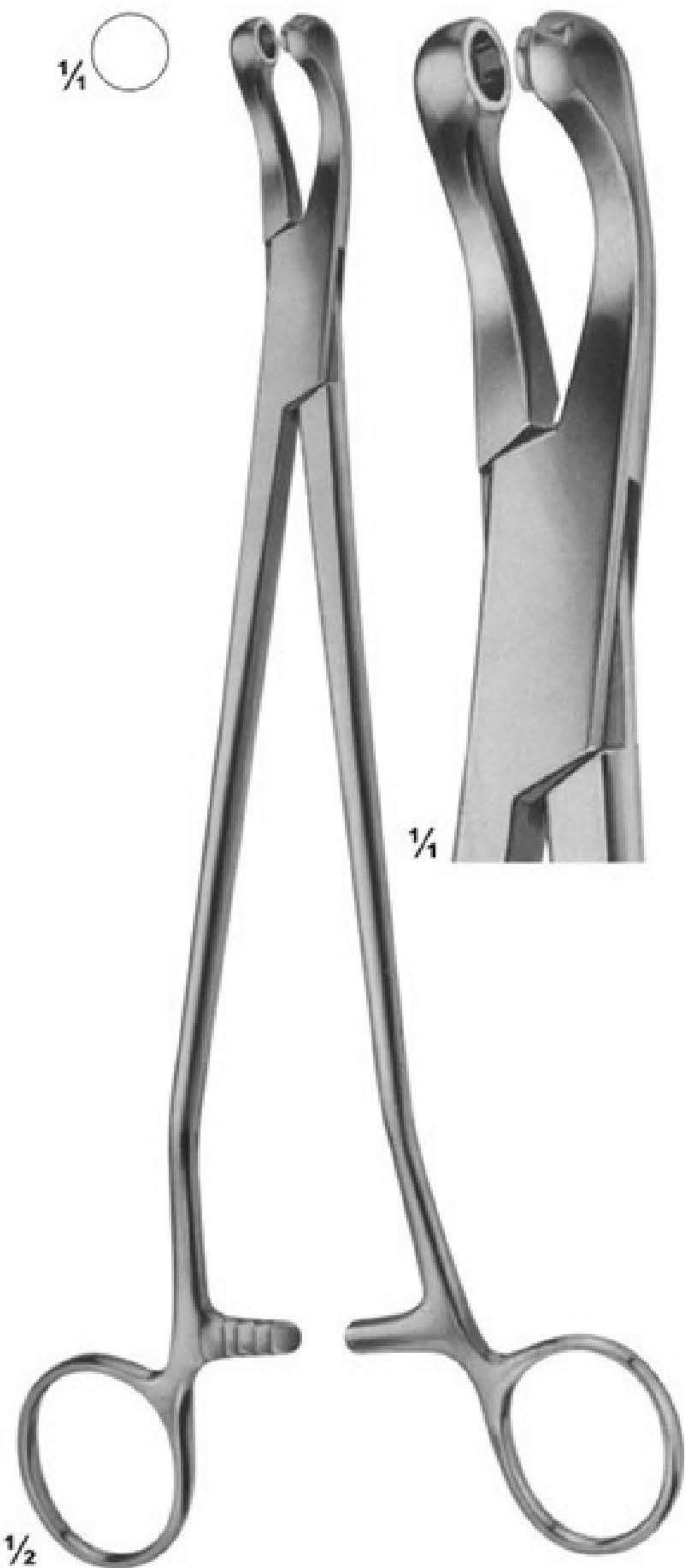

04-6269
 THOMS-GAYLOR
 240 mm

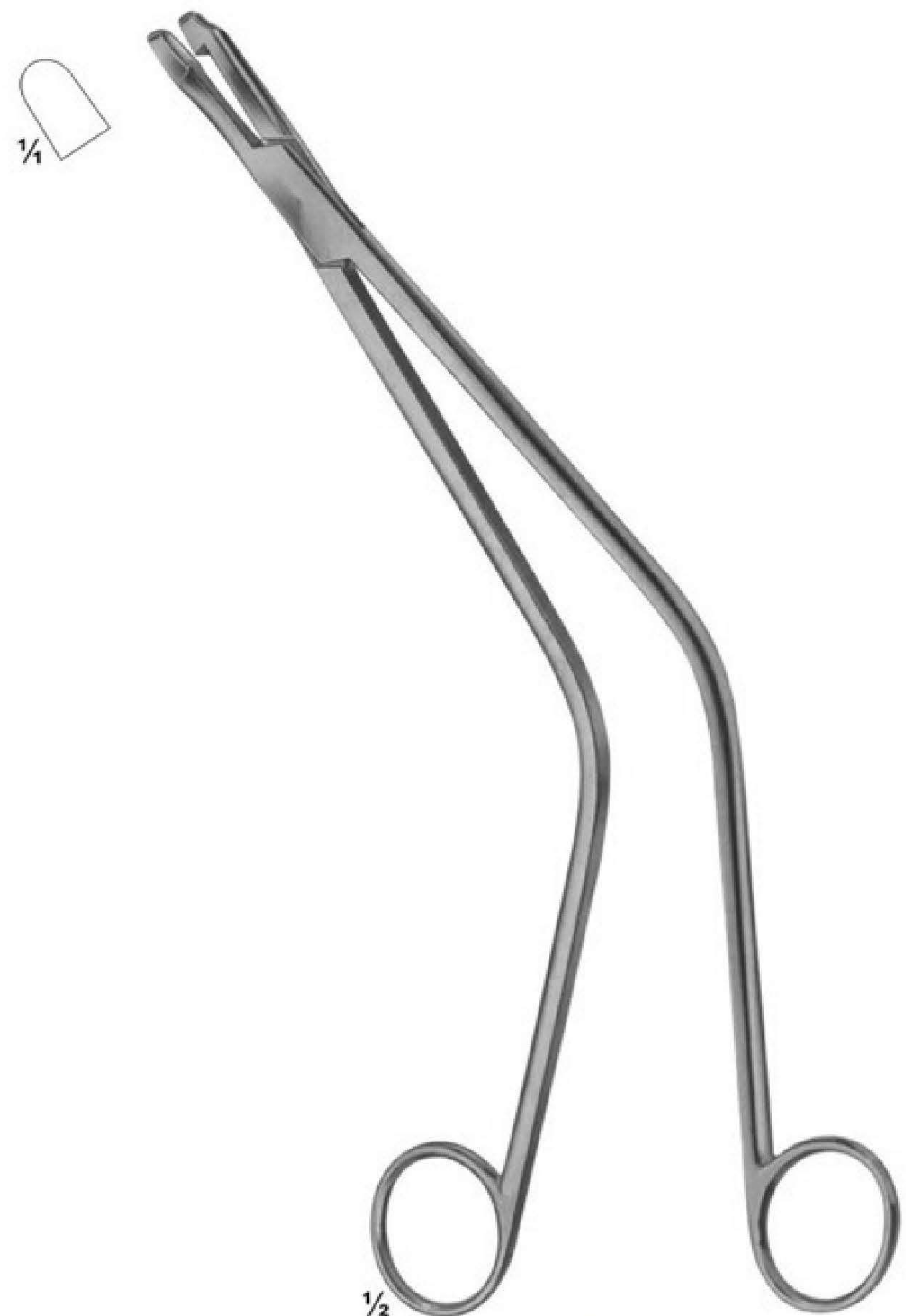

04-6270
 SCHUBERT
 260 mm

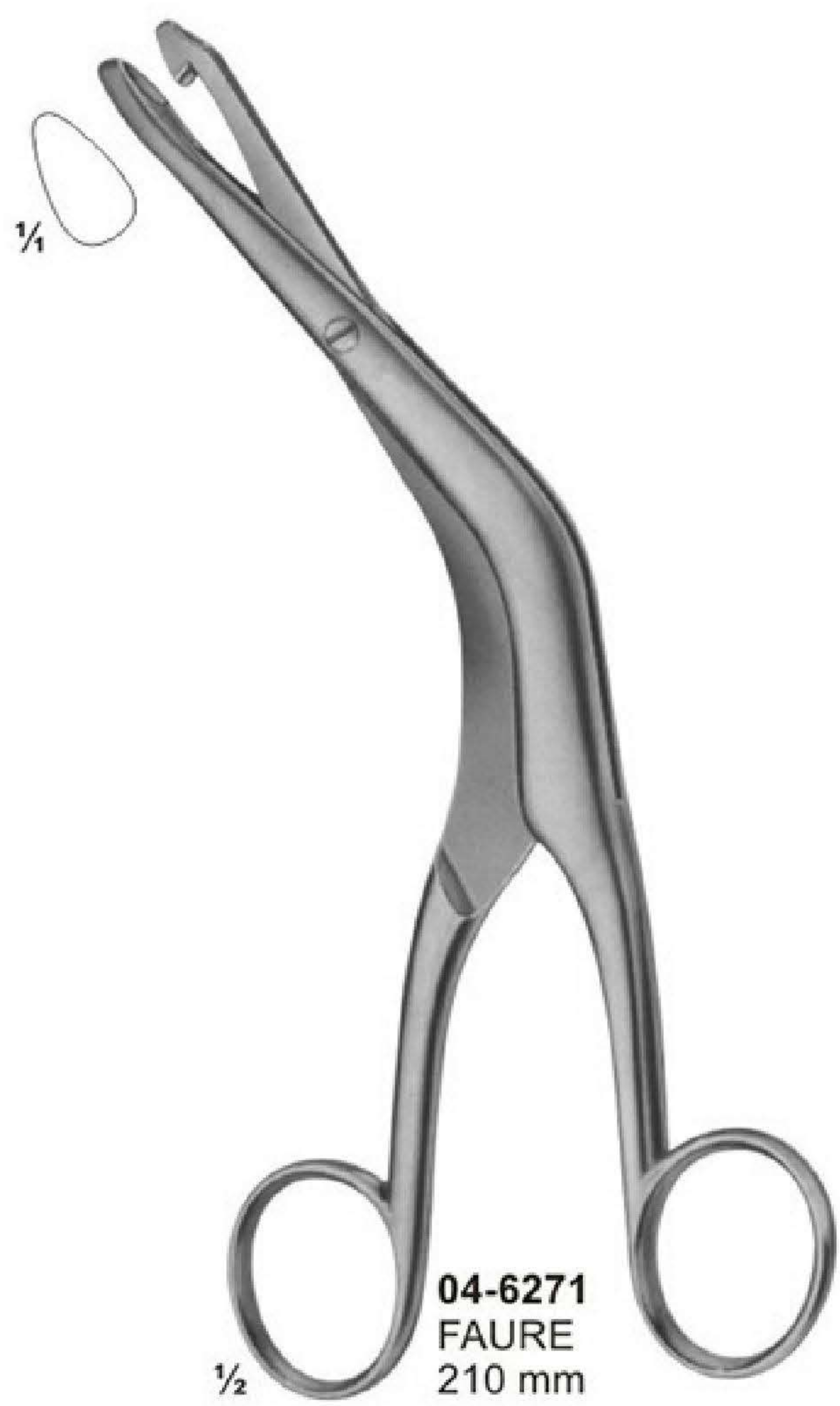

04-6271
 FAURE
 210 mm

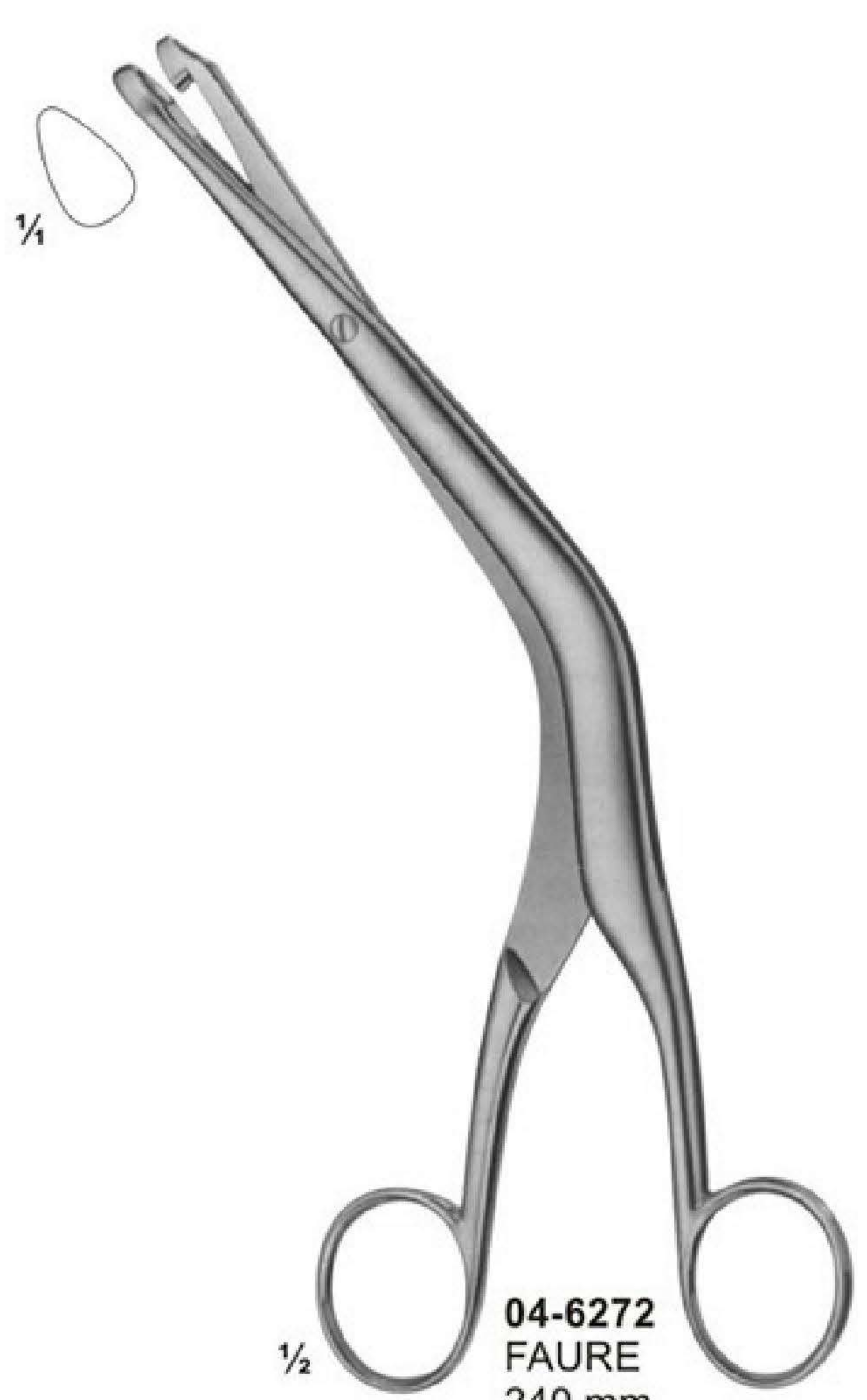

04-6272
 FAURE
 240 mm

Biopsy Forceps

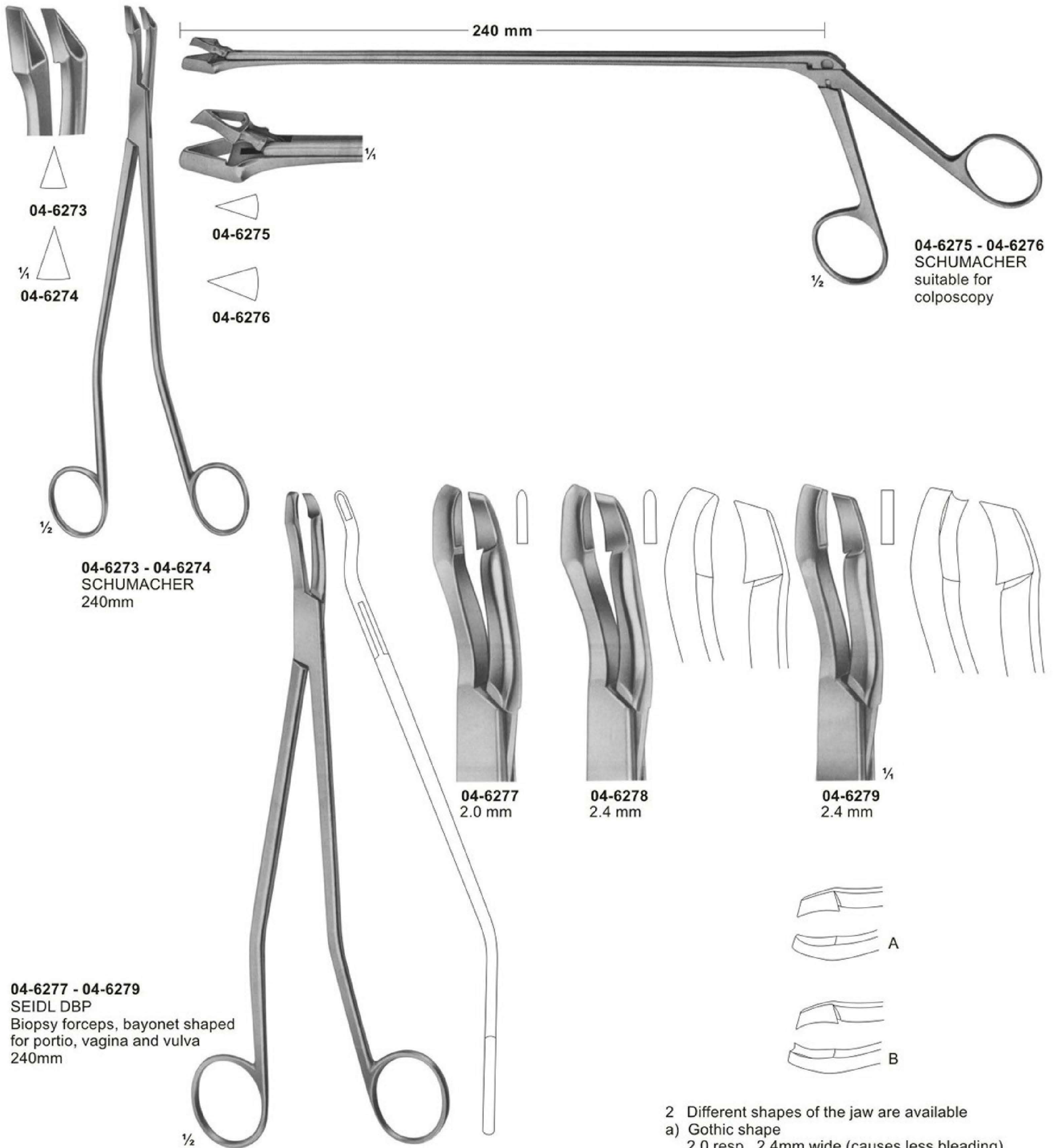

04-6273

1/4
 04-6274

04-6275

04-6276

04-6275 - 04-6276
 SCHUMACHER
 suitable for
 colposcopy

04-6273 - 04-6274
 SCHUMACHER
 240mm

04-6277
 2.0 mm

04-6278
 2.4 mm

04-6279
 2.4 mm

04-6277 - 04-6279
 SEIDL DBP
 Biopsy forceps, bayonet shaped
 for portio, vagina and vulva
 240mm

2 Different shapes of the jaw are available
 a) Gothic shape
 2.0 resp 2.4mm wide (causes less bleeding)
 b) Rectangular shape, 2.4mm wide

Biopsy Forceps

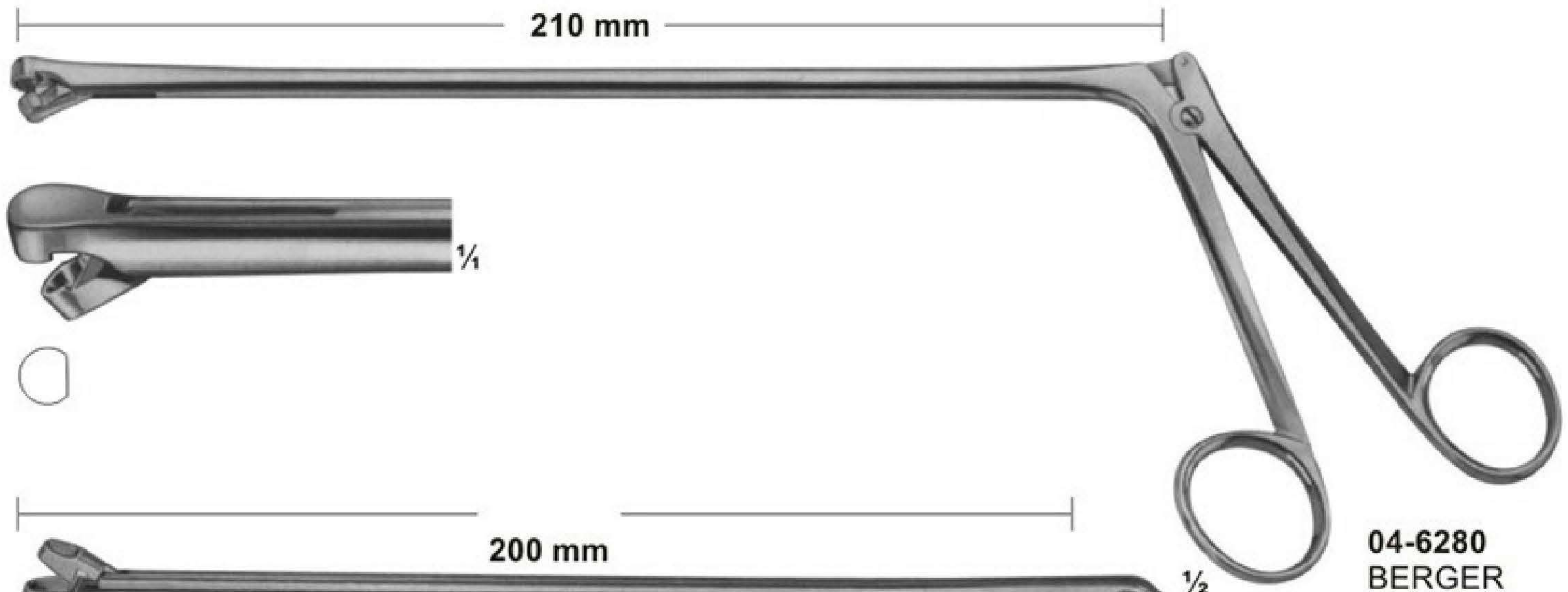

04-6280
BERGER

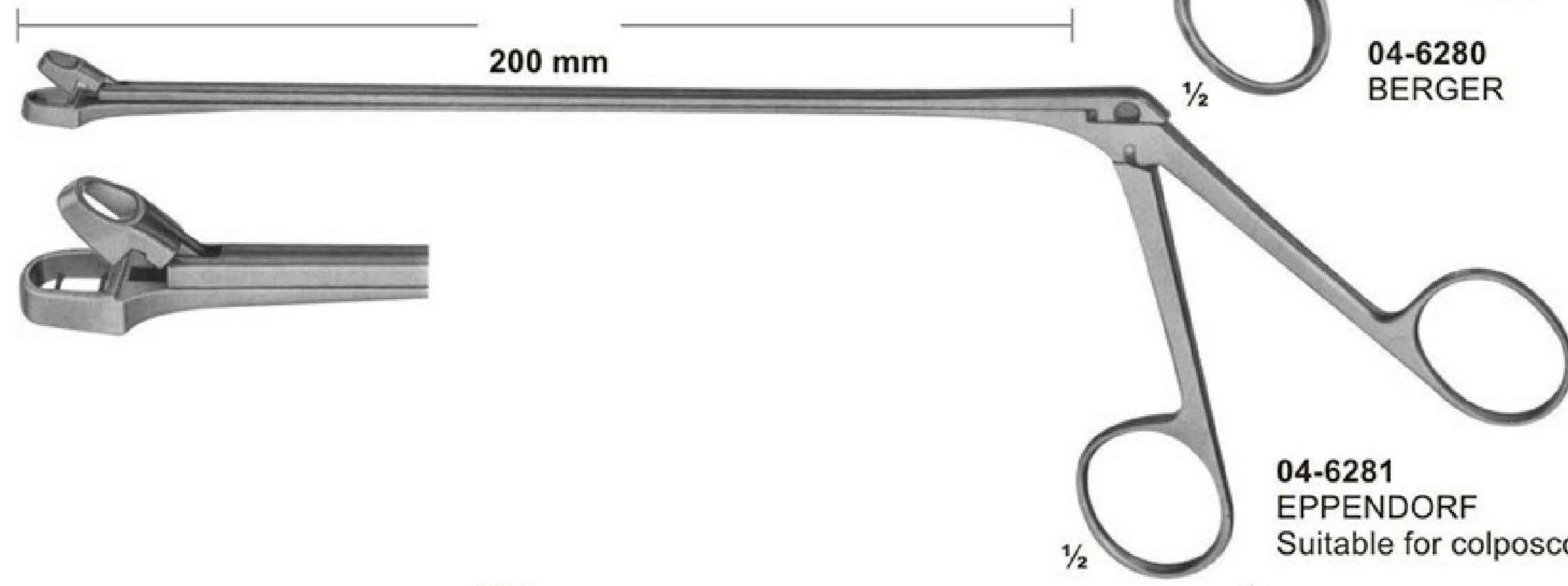

04-6281
EPPENDORF
Suitable for colposcopy

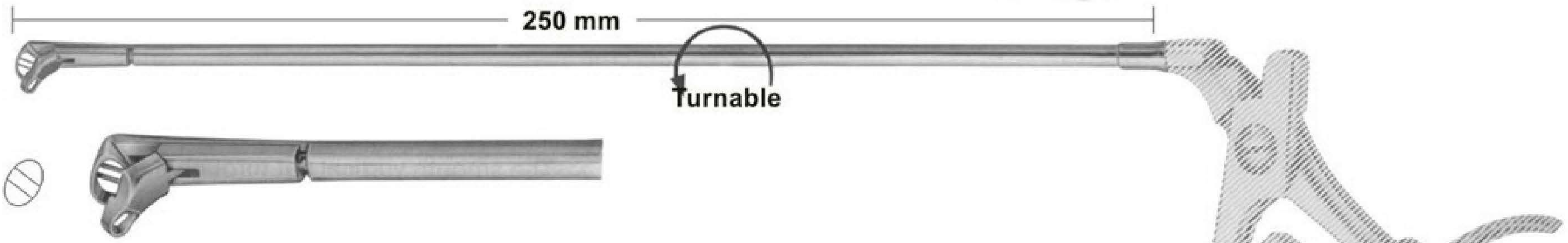

04-6282

universal handle
with drawing cut,
beginning from the top

04-6283
attachment only

04-6282
for handle



04-6282
HUBER
140 mm



04-6284
HUBER
140 mm



Extension cannulae

04-6285 BRUENINGS
04-6286 BRUENINGS

200 mm Length
250 mm Length



04-6287 **04-6288**

04-6289 KRAUSE (Biopsy tip)



04-6290 SCHEINMANN (Biopsy tip)



04-6291 SCHUMACHER
(Biopsy tip) with drawing cut

Uterine Scoops

Table of Recamier		Sharp		Blunt
Fig	Width	Rigid	Malleable	Rigid
00	4.5mm	04-6294		
0	7.5mm	04-6295		04-6306
1	8.5mm	04-6296	04-6317	04-6307
2	10.5mm	04-6297	04-6318	04-6308
3	12.0mm	04-6298	04-6319	04-6309
4	14.0mm	04-6299	04-6320	04-6310
5	15.0mm	04-6300	04-6321	04-6311
6	16.5mm	04-6301	04-6322	04-6312
7	18.0mm	04-6302	04-6323	04-6313
8	19.5mm	04-6303	04-6324	04-6314
9	21.5mm	04-6304		04-6315
10	23.5mm	04-6305		04-6316
04-6294- 04-6305		Sharp - Rigid		
04-6317- 04-6324		Sharp - Malleable		
04-6306- 04-6316		Blunt - Rigid		



04-6292
SIMON
max.240 mm

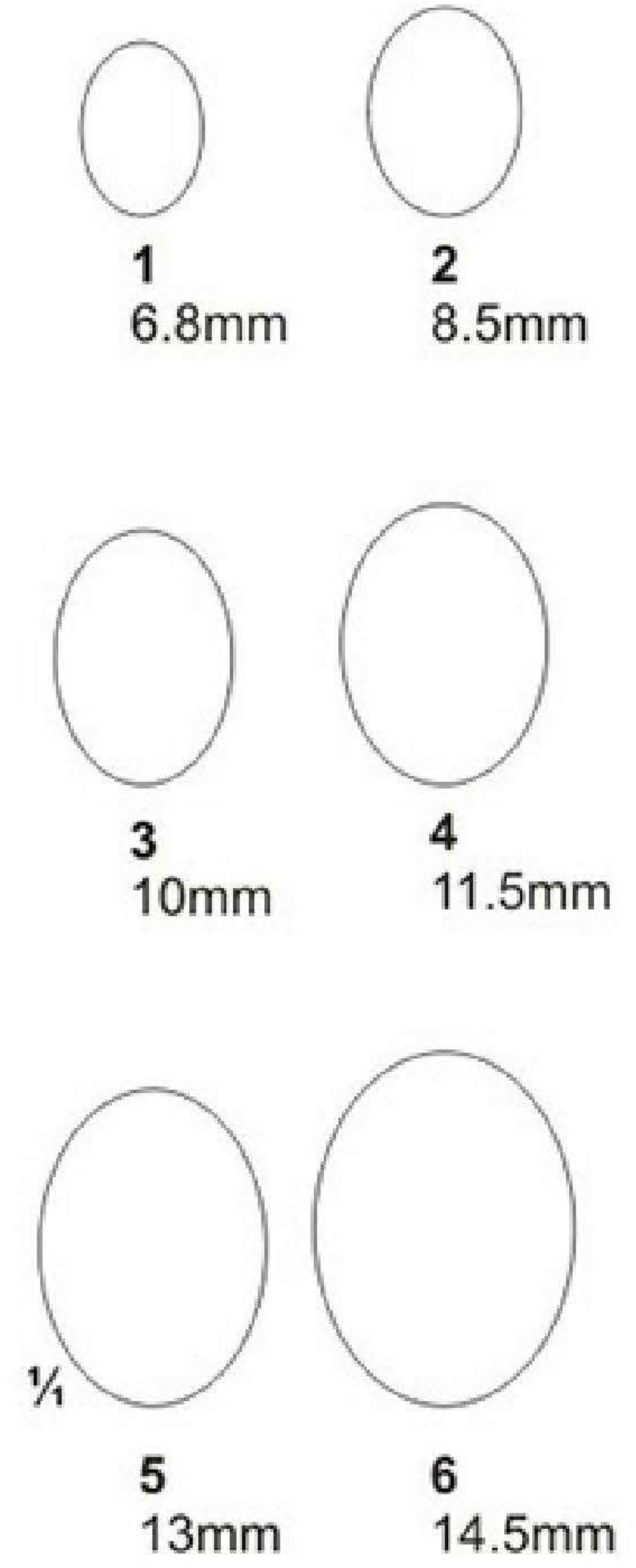

04-6293
SCHRODER
max.310 mm

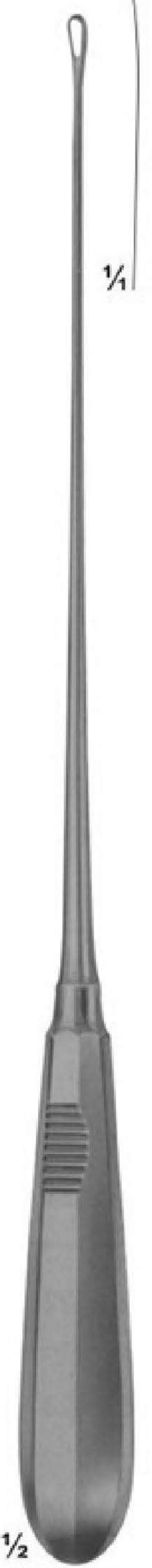
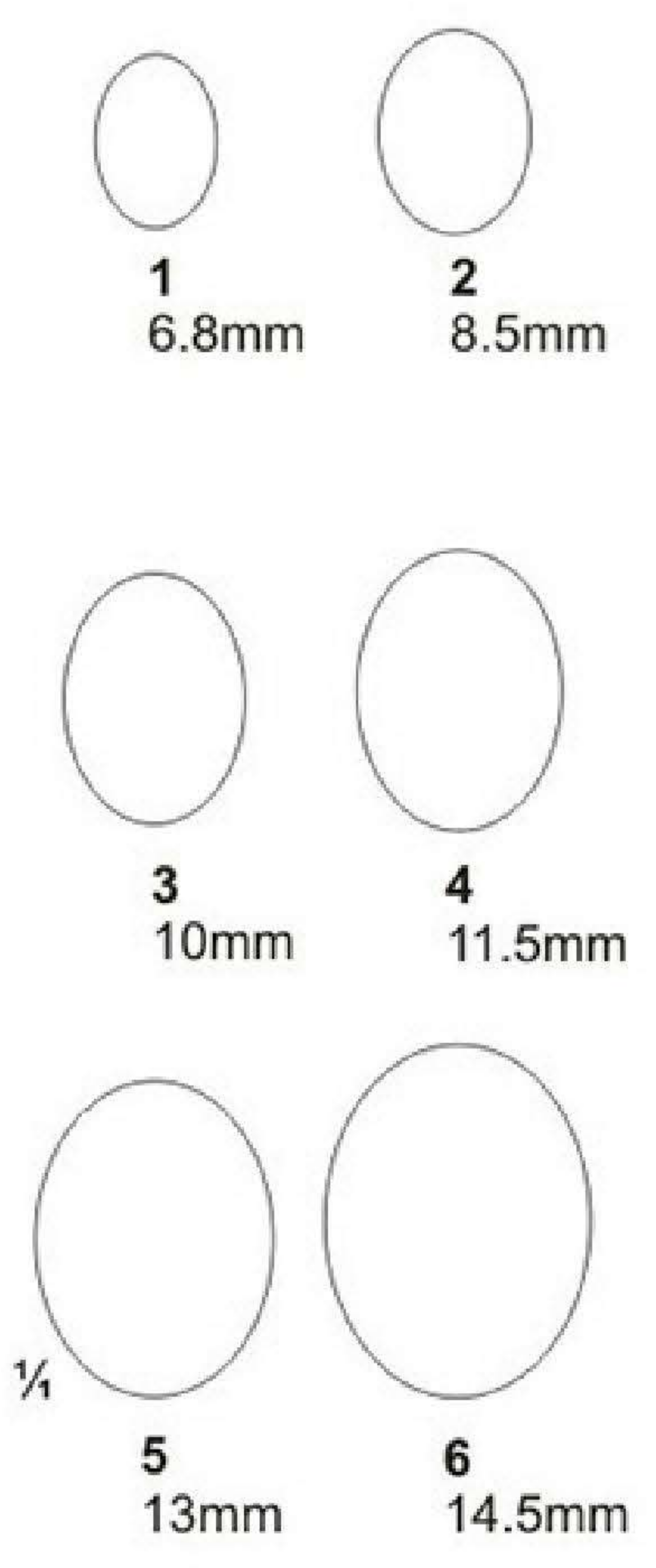

04-6294
RECAMIER
max.300 mm

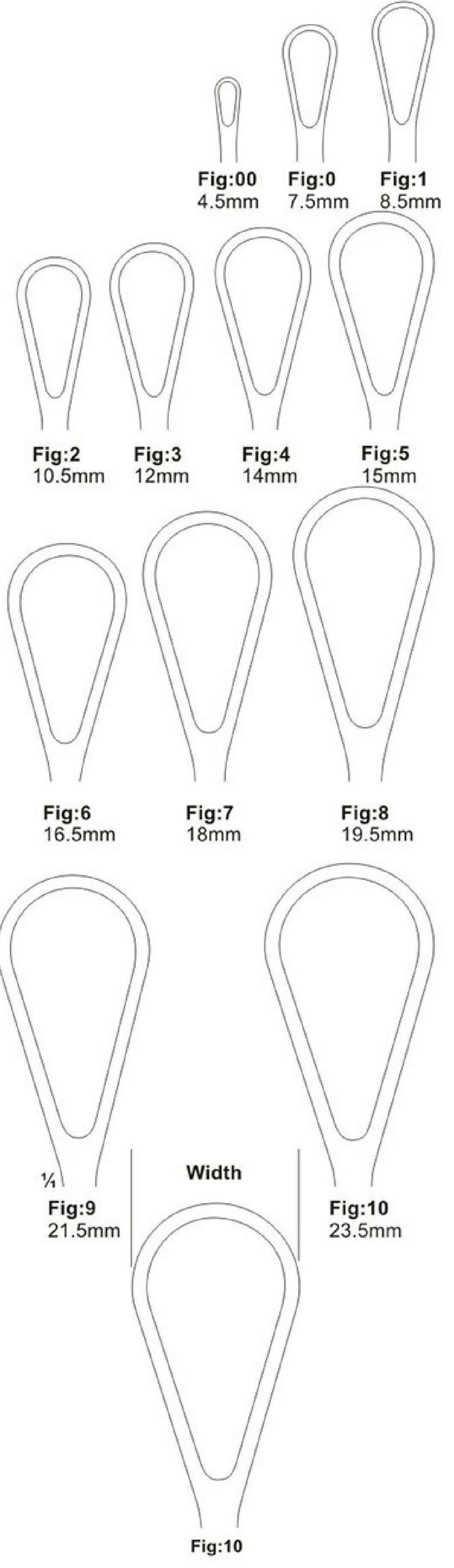

Uterine Curettes

Fig	Width	Sharp		Blunt
		Rigid	Malleable	Rigid
1	7.5mm	04-6325	04-6331	04-6337
2	8.5mm	04-6326	04-6332	04-6338
3	10.5mm	04-6327	04-6333	04-6339
4	12.0mm	04-6328	04-6334	04-6340
5	14.0mm	04-6329	04-6335	04-6341
6	15.0mm	04-6330	04-6336	04-6342

04-6325 - 04-6330 Sharp - Rigid
04-6331 - 04-6336 Sharp - Malleable
04-6337 - 04-6342 Blunt - Rigid

Fig	Width	Blunt - Malleable
0	16.5mm	04-6343
1	18.5mm	04-6344
2	19.5mm	04-6345
3	21.5mm	04-6346
4	23.5mm	04-6347
5	26.0mm	04-6348
6	28.5mm	04-6349

BUMM

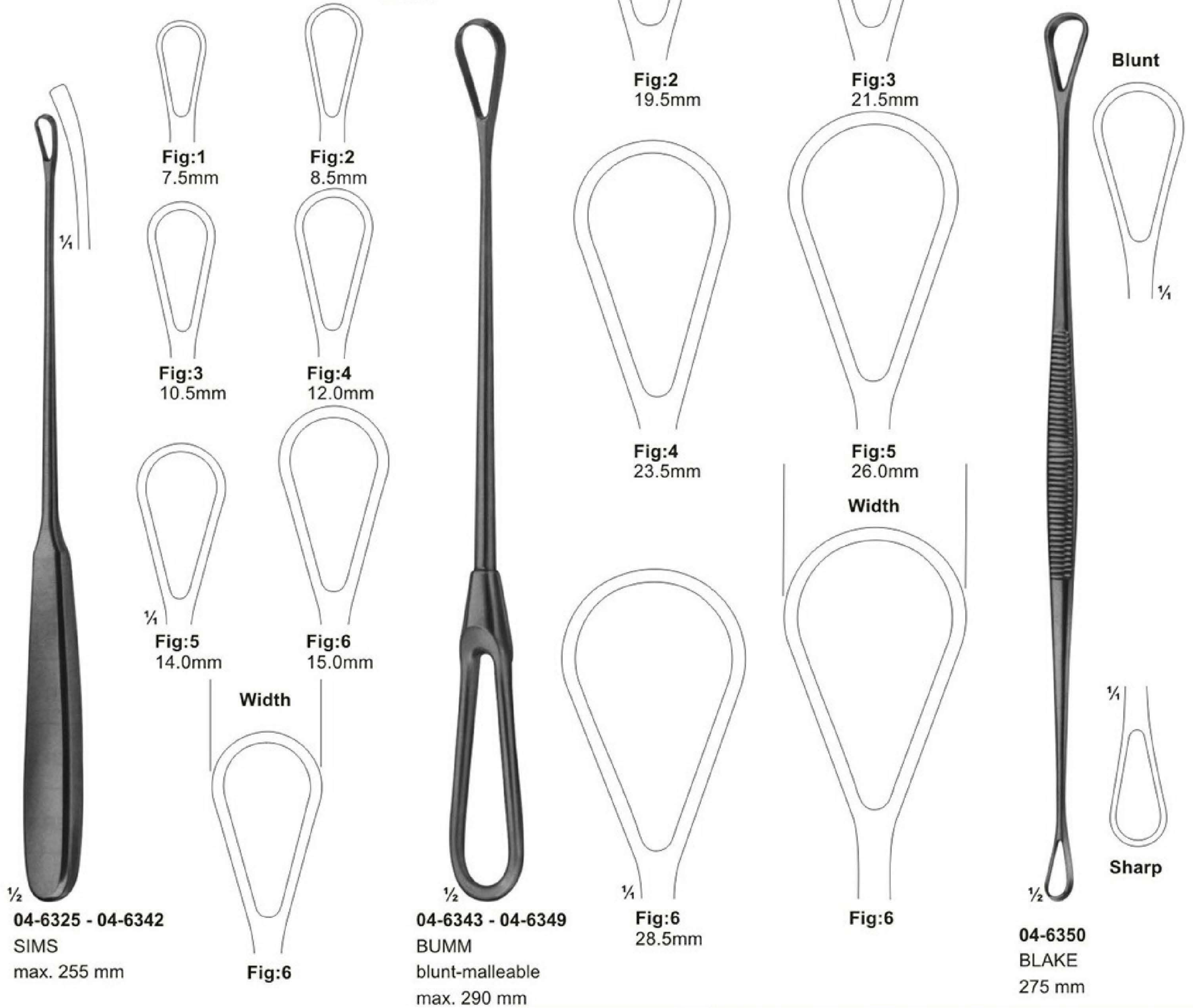

Placenta-and Ovum Curettes

Fig	Width	Sharp Malleable	Blunt Malleable
1	23.5mm	04-6354	04-6356
2	26.0mm		04-6357
3	28.5mm	04-6355	04-6358



04-6351
COLLIN
300 mm

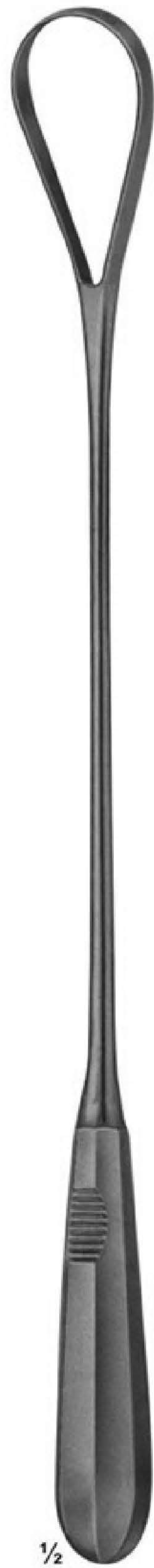

04-6352 - 04-6353
RECAMIER
blunt-rigid
max. 360 mm

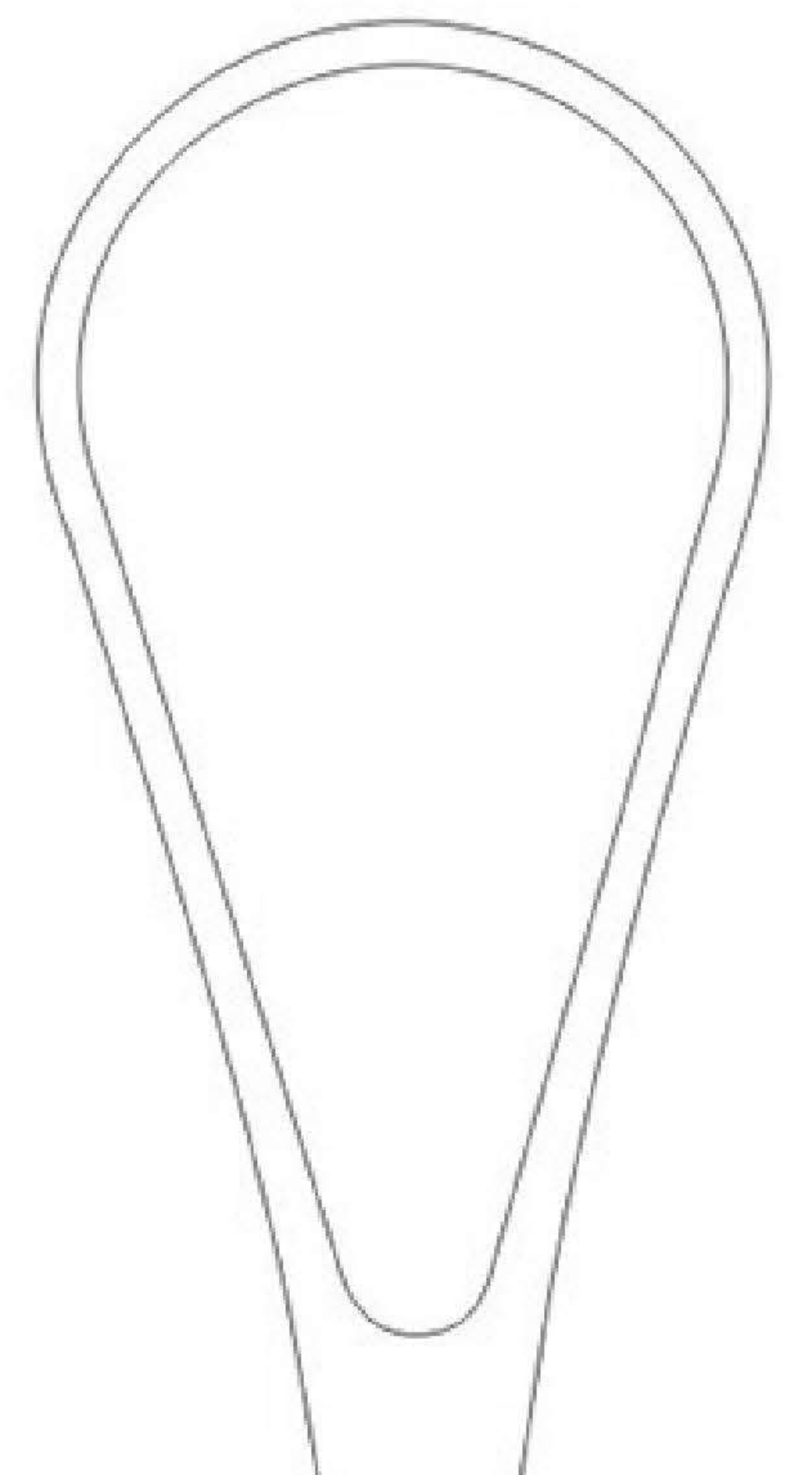
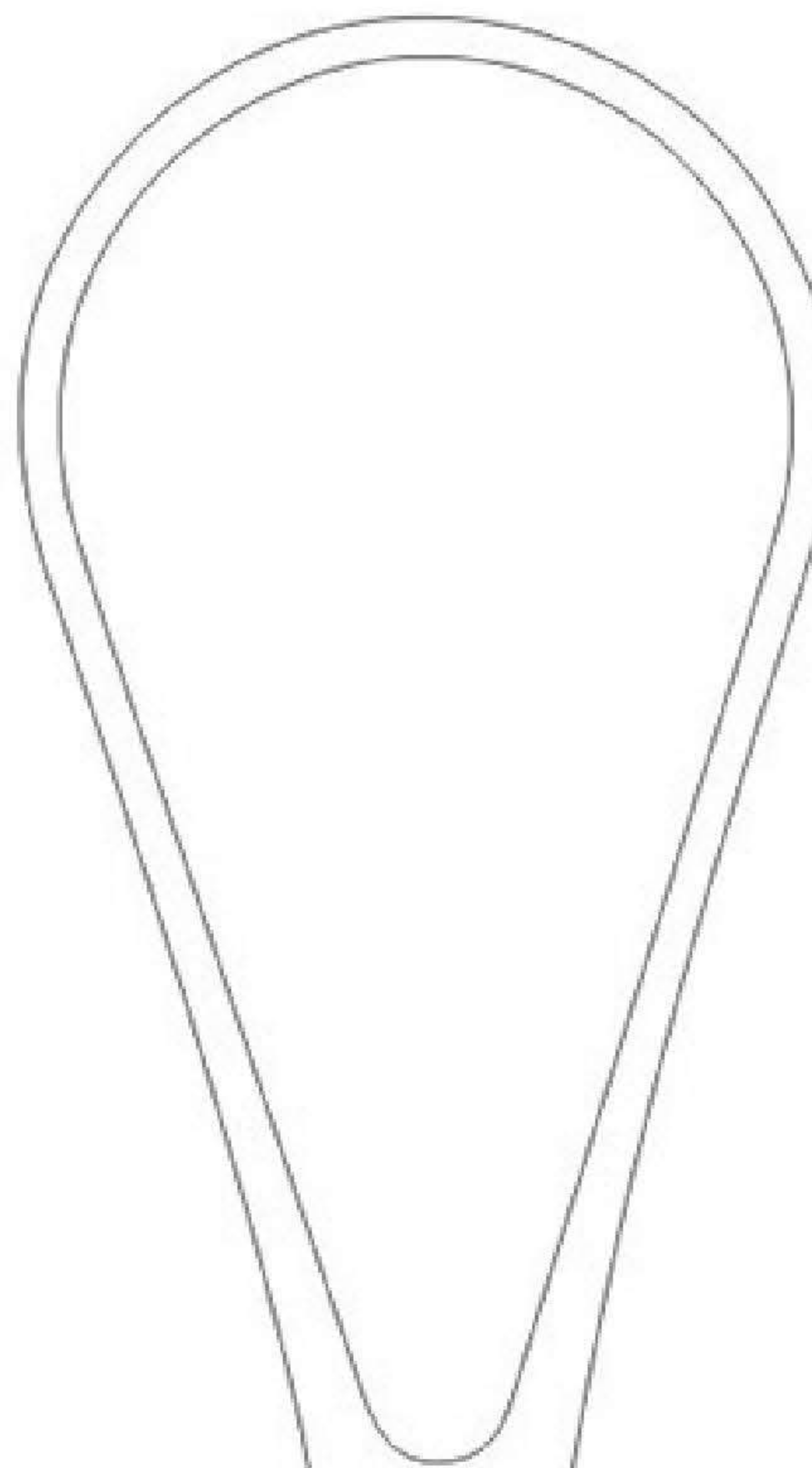
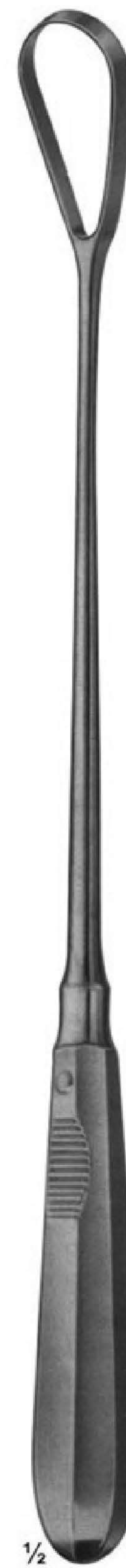

Fig:1



1/4

Fig:2



04-6354 - 04-6358
BUMM
max. 310 mm

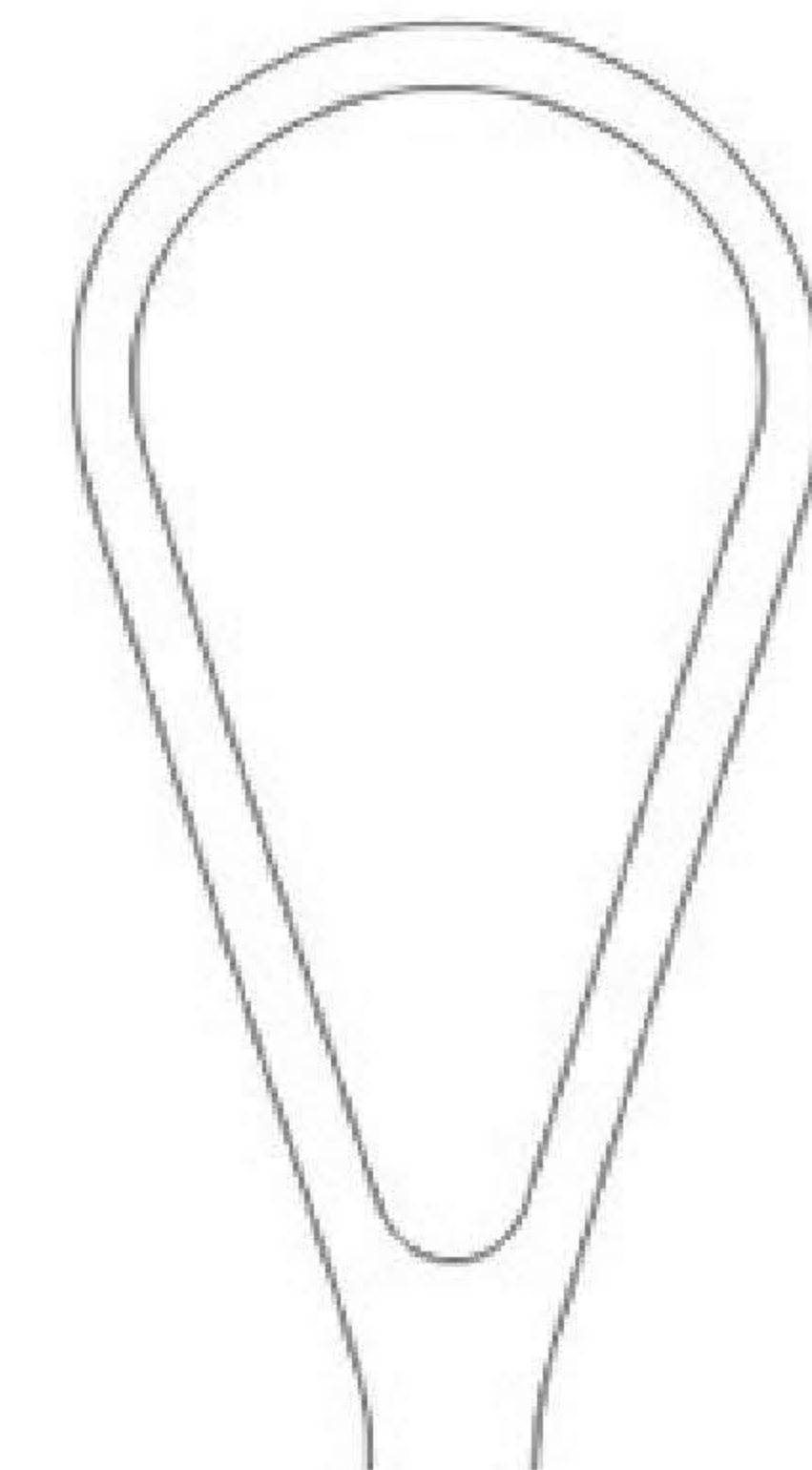

Fig:1

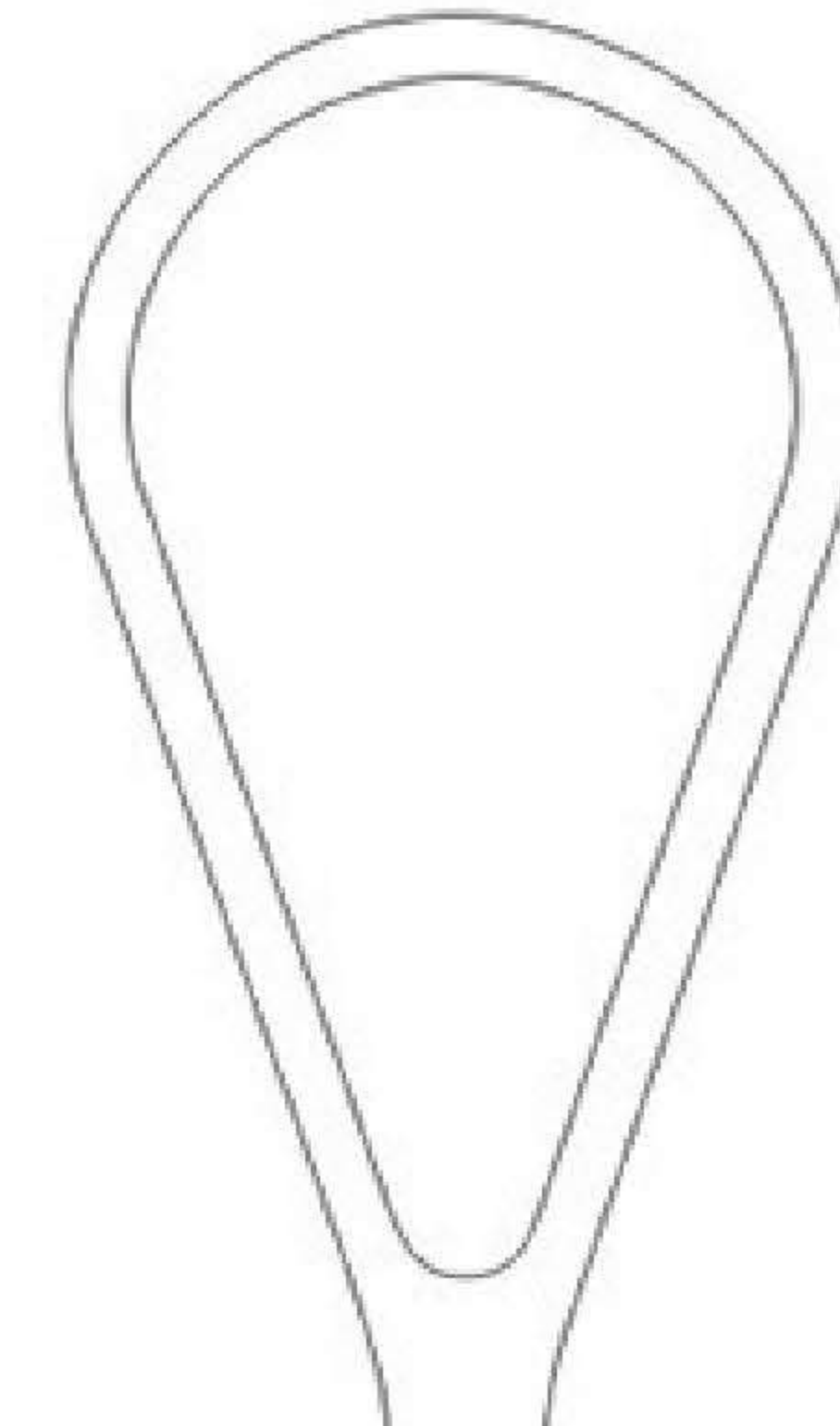
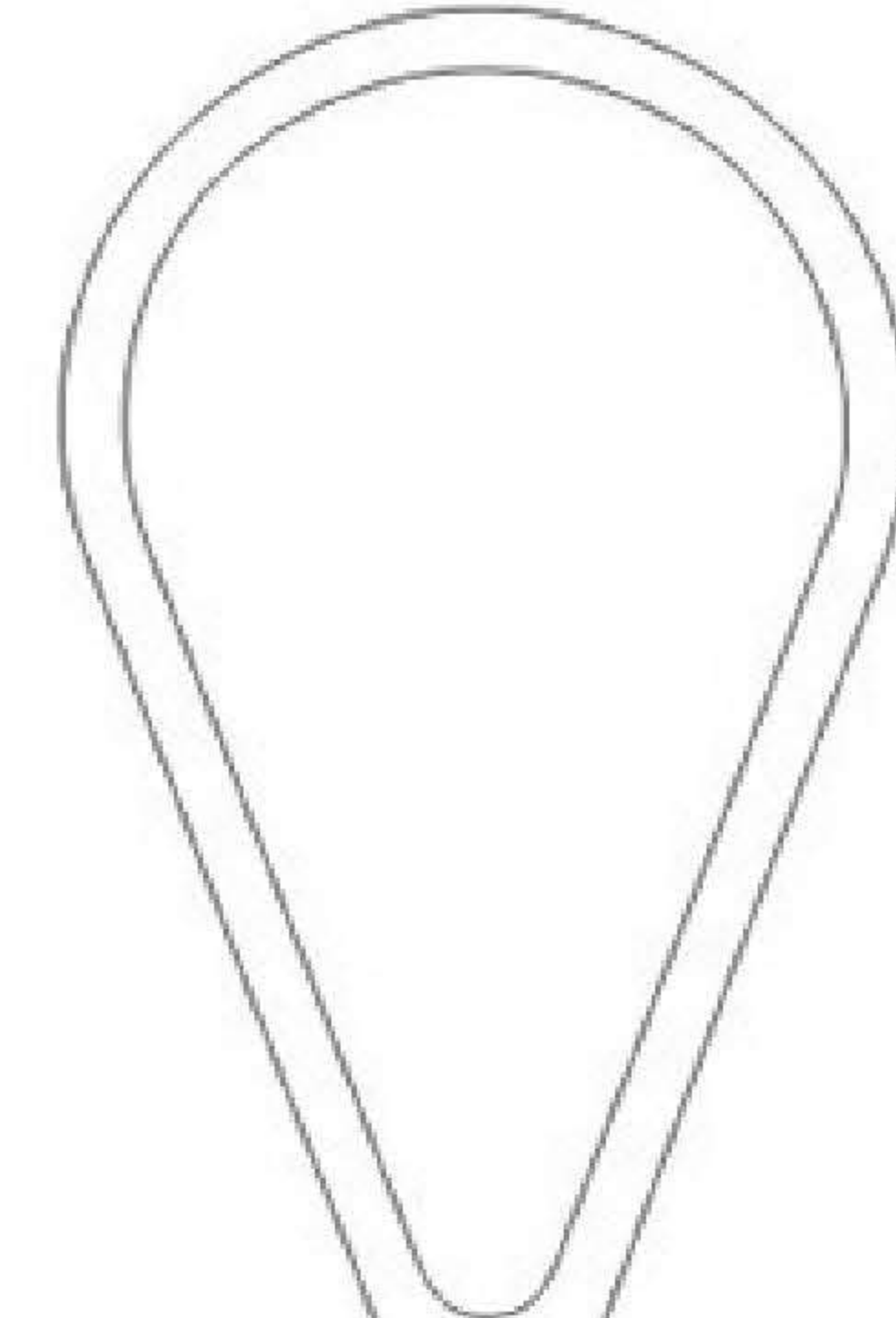

Fig:2



1/4

Fig:3

Fig	Width	Blunt Rigid
1	34.5mm	04-6352
2	39.5mm	04-6353

04-6354 - 04-6355	sharp-malleable
04-6356 - 04-6358	blunt-malleable

Vacuum Currettes

04-6359 - 04-6364

Suction currettes, stainless steel, fitting hose connection.
 Working tips are smoothly rounded off, therefore no danger of perforation.

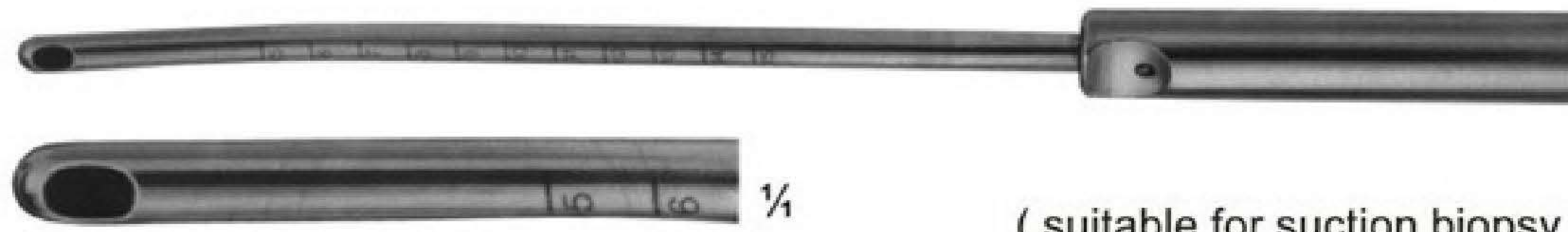

(suitable for suction biopsy)
 04-6359: diam 4 mm
 04-6360: diam 6 mm
 04-6361: diam 8 mm
 04-6362: diam 10 mm
 04-6363: diam 12 mm
 04-6364: diam 14 mm

04-6365
 Hose connection inside diam. 11 mm, curved, stainless steel.



The new connection between suction currette and hose connection, (04-6365) Guarantees quick changing and free turning of the suction currettes on the hose connection.

04-6366
 Transparent suction hose 1.8 mm long, inside diam 11 mm, outside diam 16.5 mm can be sterilized in an autoclave at 1 bar overpressure (120°C)

04-6367
 Strainer for tissues, plastic, for single use only, to be used for histopathological examination.



Gynaecological Instruments



04-6368 diam 8 mm
04-6369 diam 10 mm
BOZEMANN-FRITSCH
Uterine Flushing Tube
350 mm

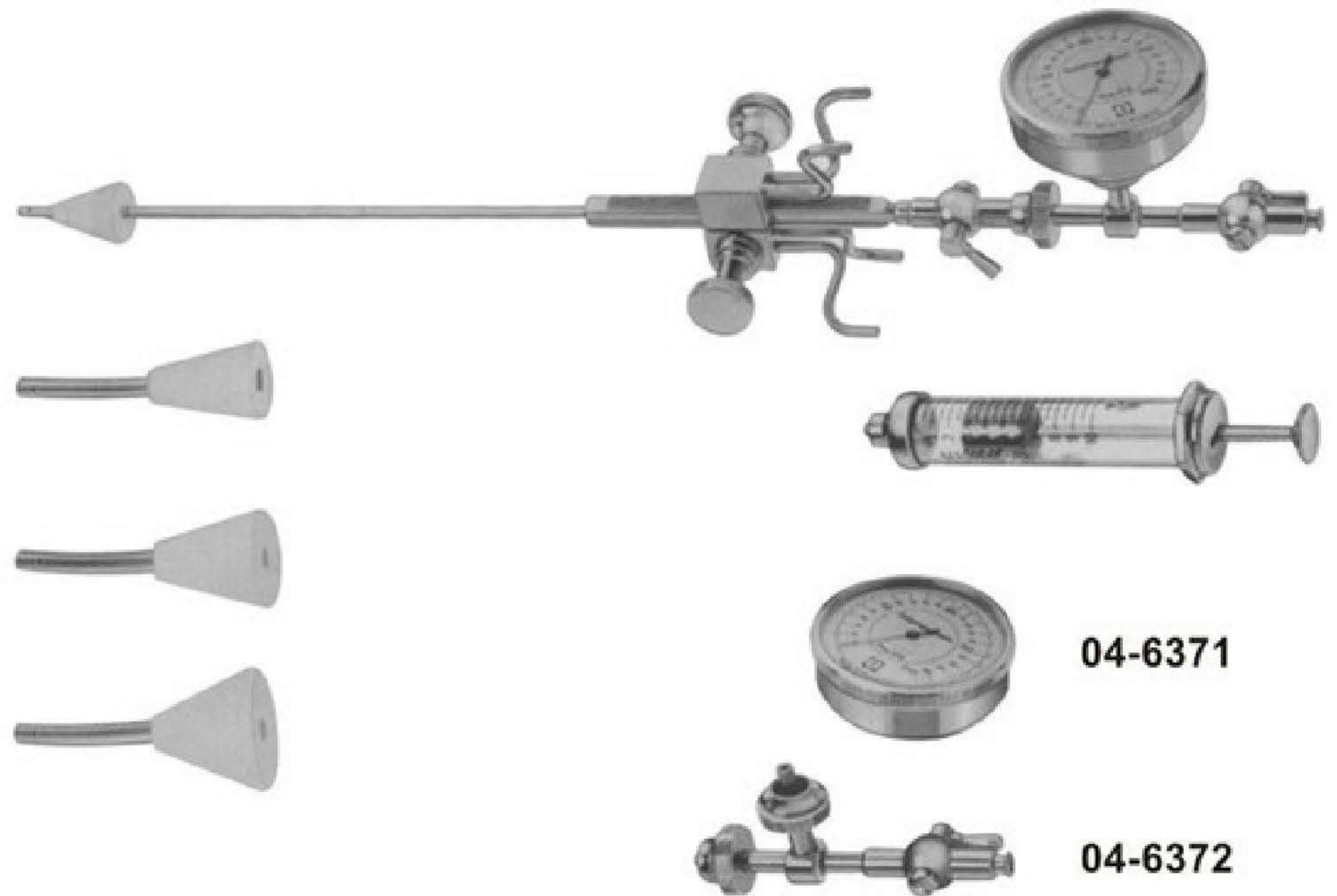

04-6370
SCHULZE
Salpingograph, for utero-salpingography
in wooden case, consisting of:
04-6371 Manometer only
04-6372 Connection only, without manometer
04-6373 Uterine cannula with tape without cone
04-6374 Cone only, small
04-6375 Cone only, medium
04-6376 Cone only, large
04-6377 Record syringe, 10CC, luer-lock mount.

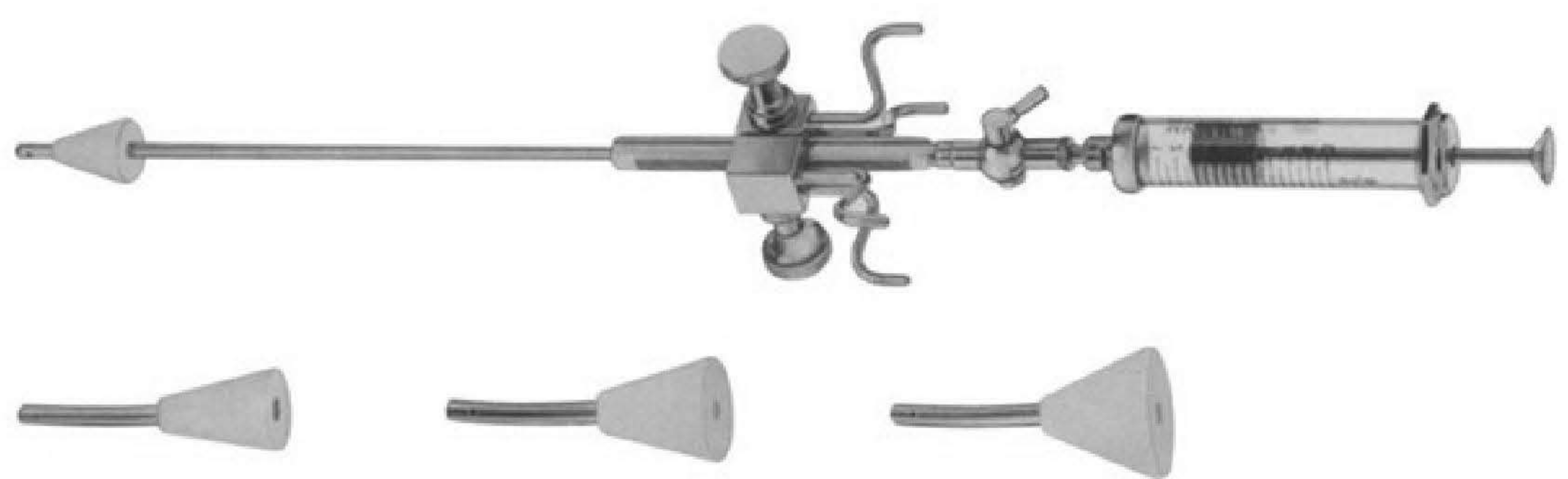
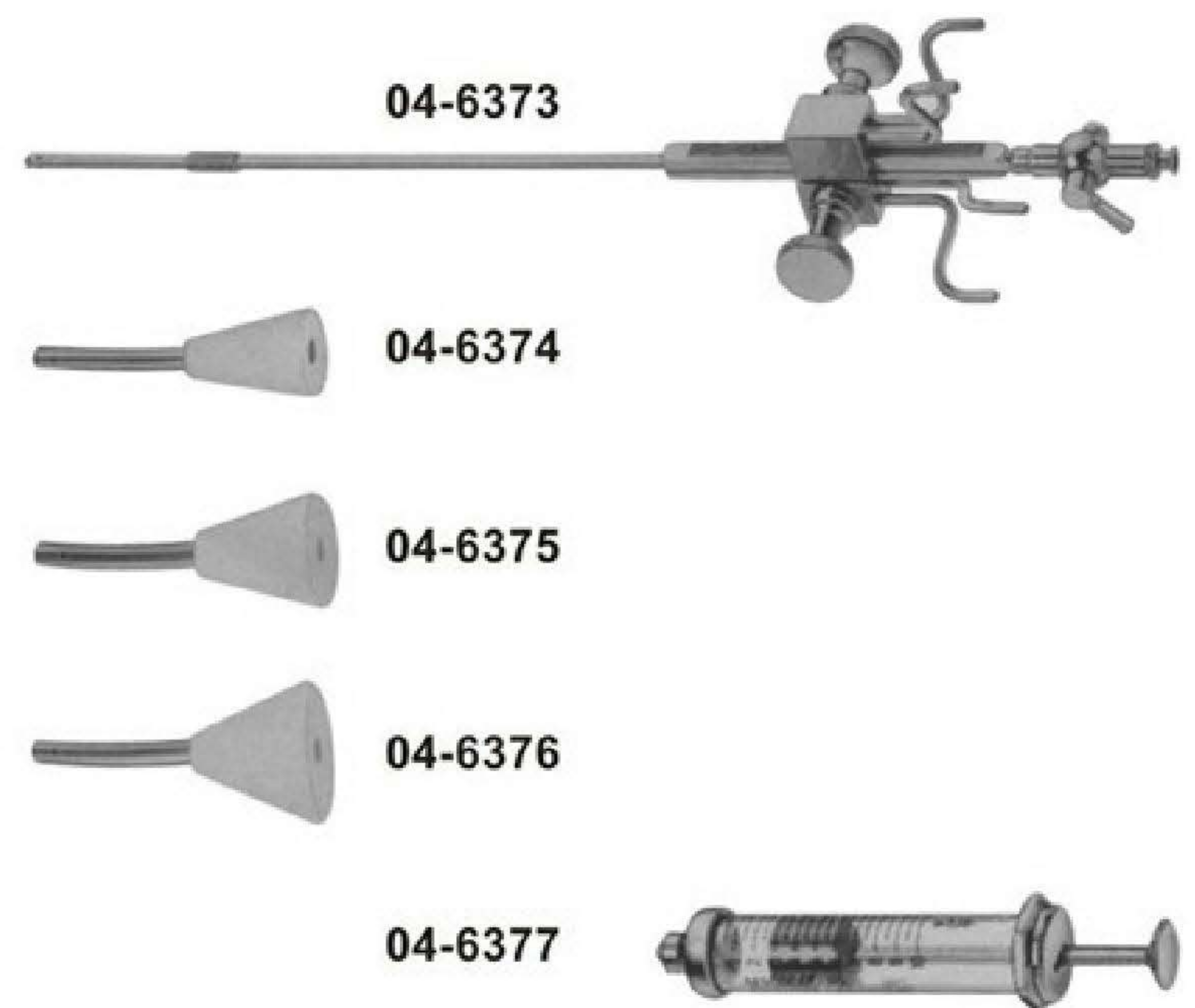

04-6378
SCHULZE
Salpingograph, equipment like(04-6370)
but without manometer.