

# Percussion Hammers & Aesthesiometers



**01-2001**  
**TROEMNER**  
 Size: 245 mm

1/2



**01-2002**  
**DEJERINE**  
 Size: 200 mm

1/2



**01-2003**  
**DEJERINE**  
 With Needle  
 Size: 210 mm

1/2



**01-2004**  
**TAYLOR**  
 Size: 195 mm

1/2



**01-2005**  
**BERLINER**  
 Size: 200 mm

1/2

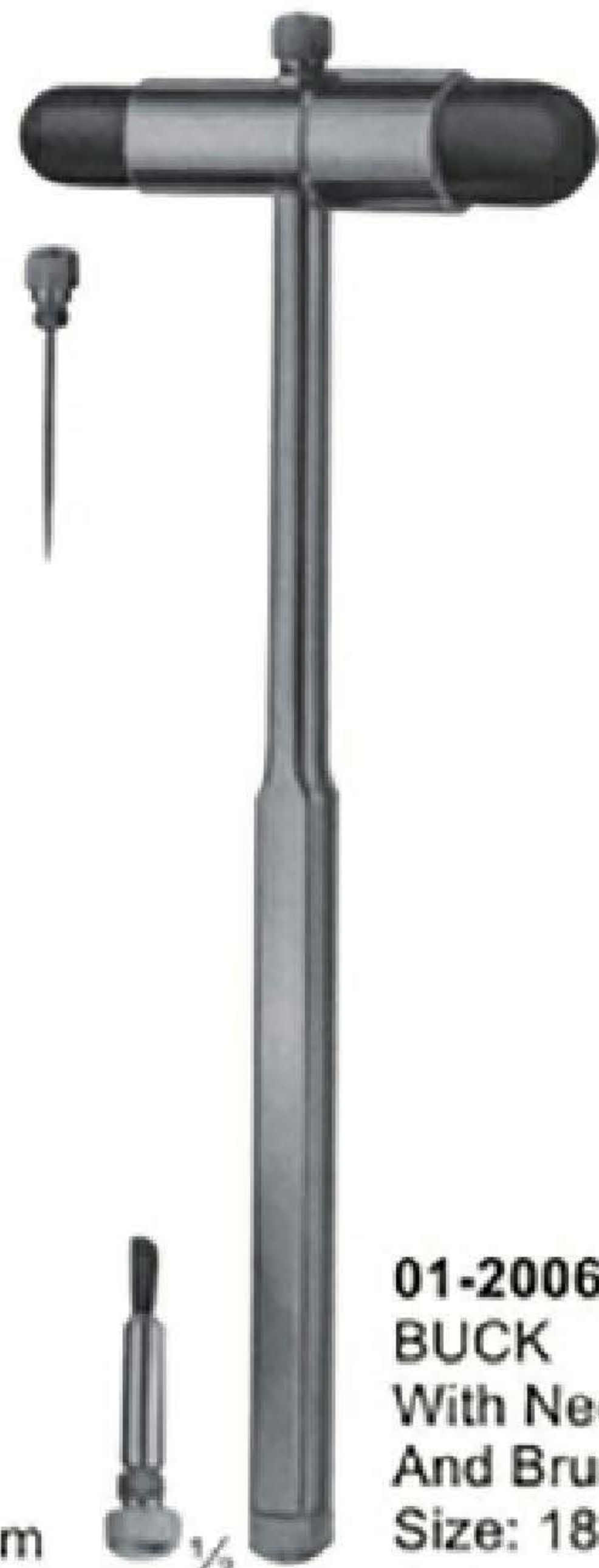

**01-2006**  
**BUCK**  
 With Needle  
 And Brush  
 Size: 180 mm

1/2



**01-2007**  
**RABINER**  
 With Needle  
 And Brush  
 Size: 255 mm

1/2



**01-2008**  
**ALY**  
 Size: 190 mm

1/2



**01-2009**  
**WARTENBERG**  
 Pinwheel For  
 Neurological  
 Examination  
 Size: 185 mm

1/2

# Stethoscopes



**01-2010**  
 PINARD  
 of aluminium  
 Size: 155 mm

1/2



**01-2011**  
 aus Holz  
 Wooden  
 Size: 145 mm

1/2



**01-2012**  
 BOWLES  
 Stethoscope With  
 Diaphragm,  
 In Plastic Pouch

1/4



**01-2013**  
 ANESTOPHON  
 Ø47mm

1/3



**01-2014**  
 FORD-BOWLES  
 Combination Stethoscope  
 With Diaphragm and Bell  
 Dual Chest Piece  
 With Two Outlets



1/4

**01-2015**  
 BOWLES  
 Stethoscope With  
 Diaphragm,  
 Flat Model,  
 Suitable Also  
 For Anaesthesia  
 Chest Piece Only  
 40 mm Diam



1/4

# Head Mirrors & Head Bands

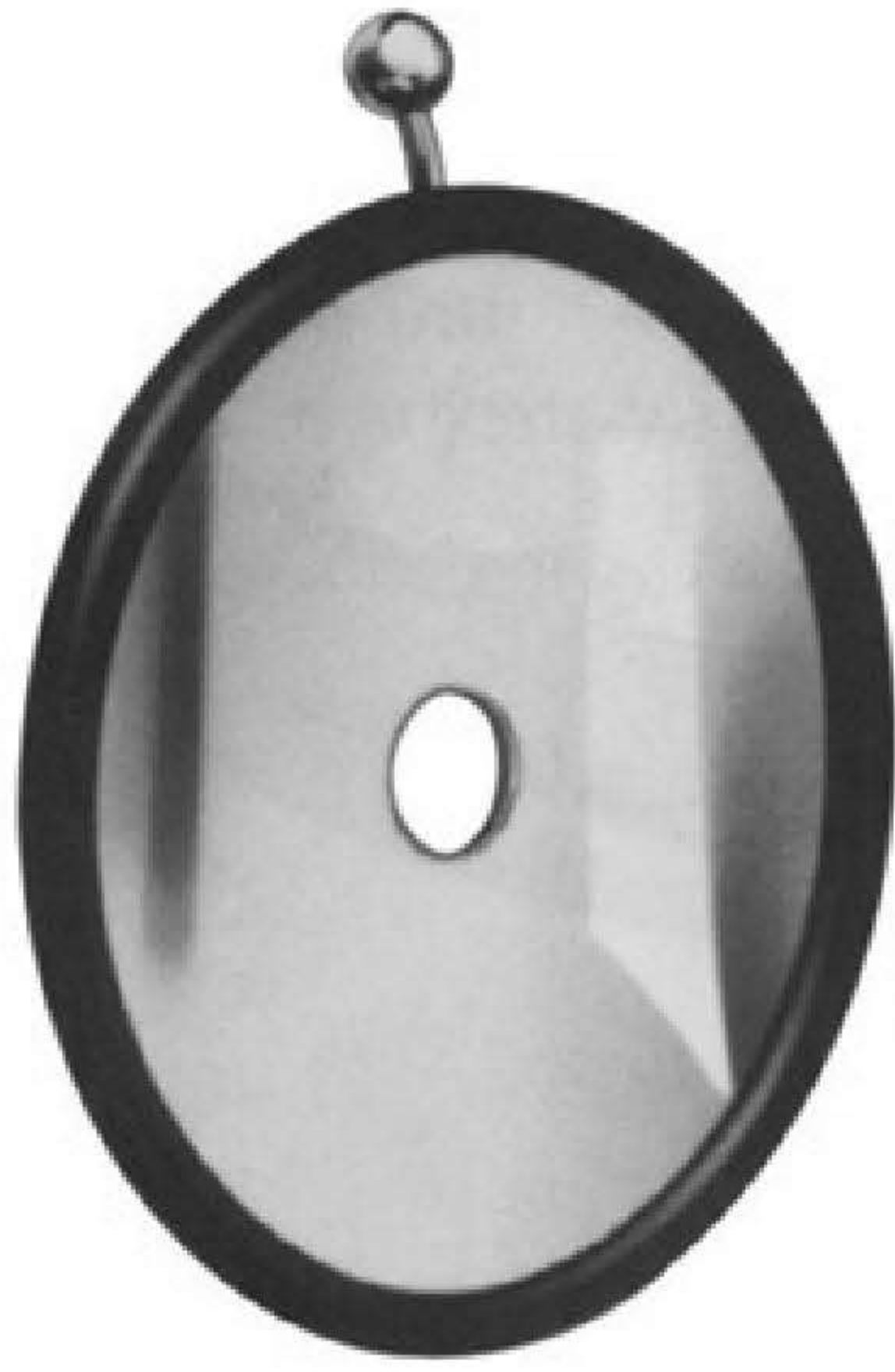

**01-2016**  
 ZIEGLER Ø 90mm  
 Head mirror only  
 with rubber coating

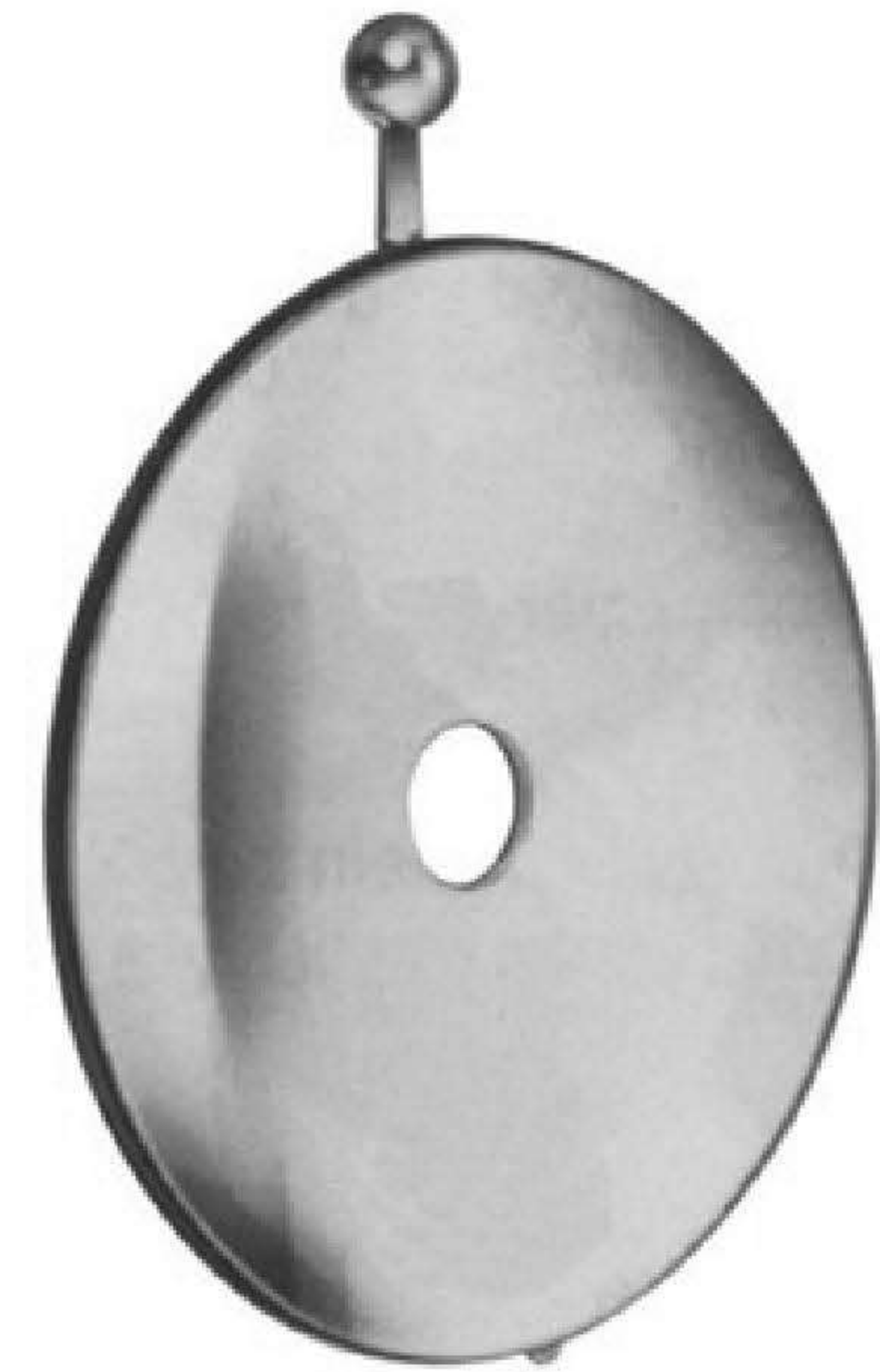

**01-2017**  
 ZIEGLER Ø 90mm  
 Head mirror only  
 with metal coating



**01-2018**  
 ZIEGLER  
 Head band of plastic, black only

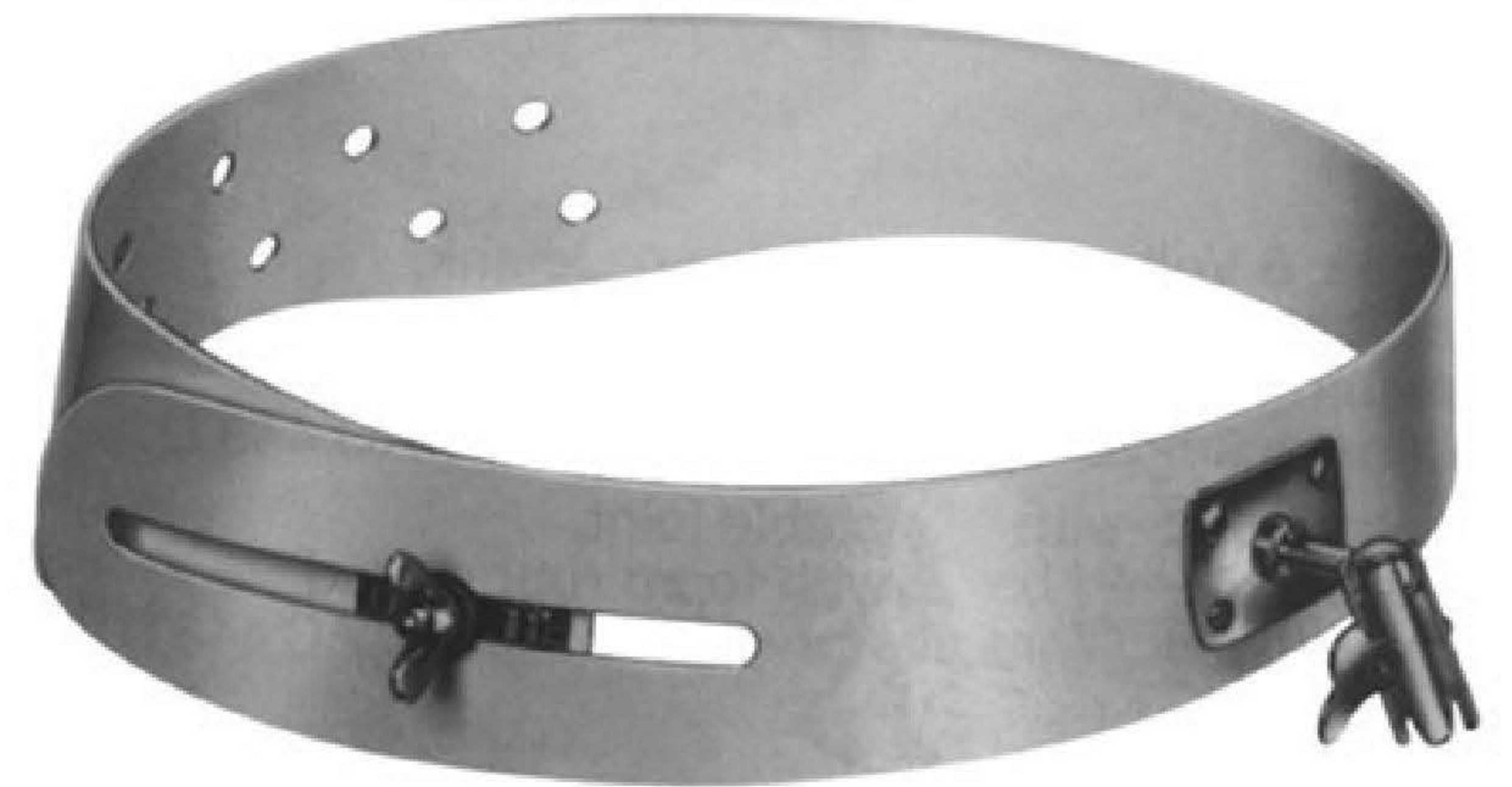

**01-2020**  
 MURPHY  
 Head band of celluloid, white only

**01-2019**  
 ZIEGLER  
 Head band of plastic, white only

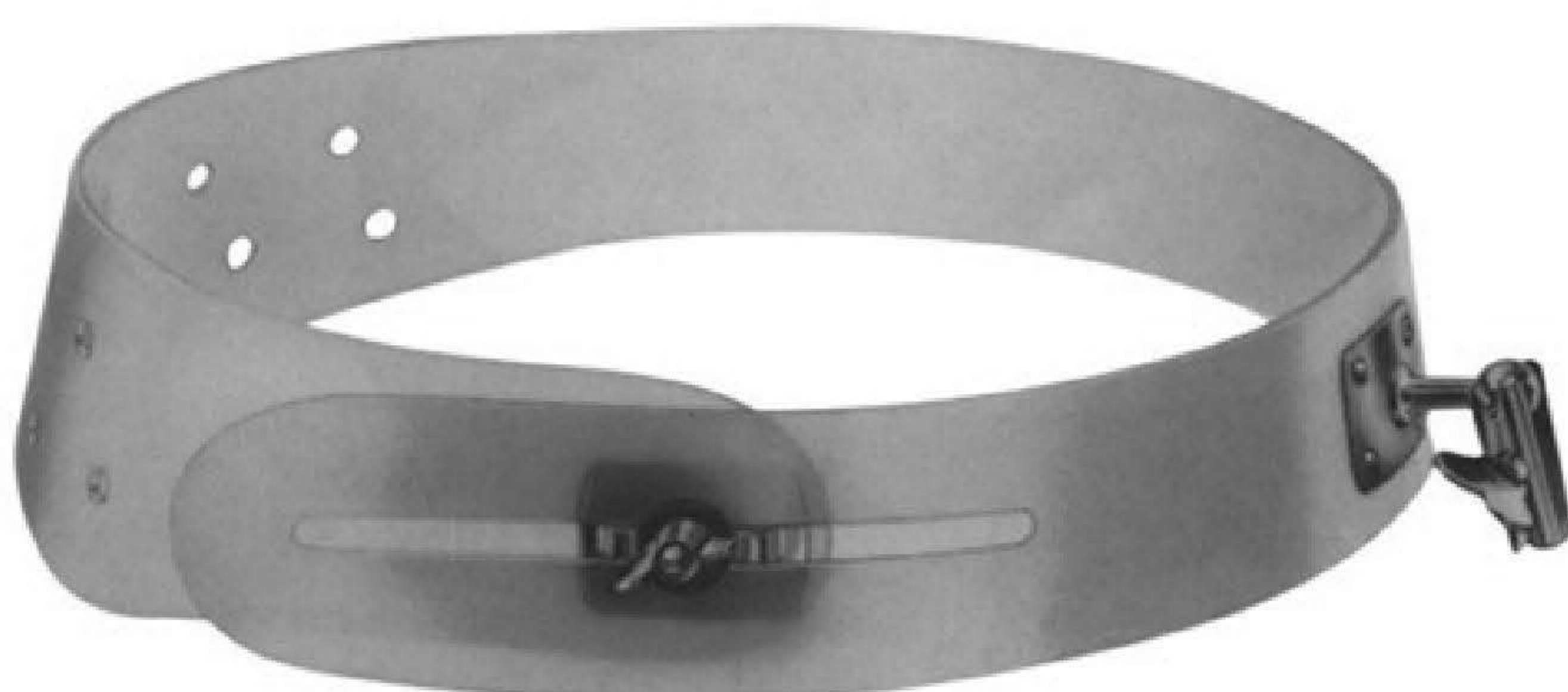

**01-2021**  
 Head band of plastic,  
 white, soft pattern



**01-2022**  
 Head mirror  
 with black plastic head  
 band

# Head Lights



**01-2023**  
CLAR  
Head light, 6 volt, with adjustable joint, white celluloid head band, cord with plugs for transformer

**01-2024**  
White celluloid head band, only, for **01-2023**

**01-2025**  
Spare mirror only, for **01-2023**

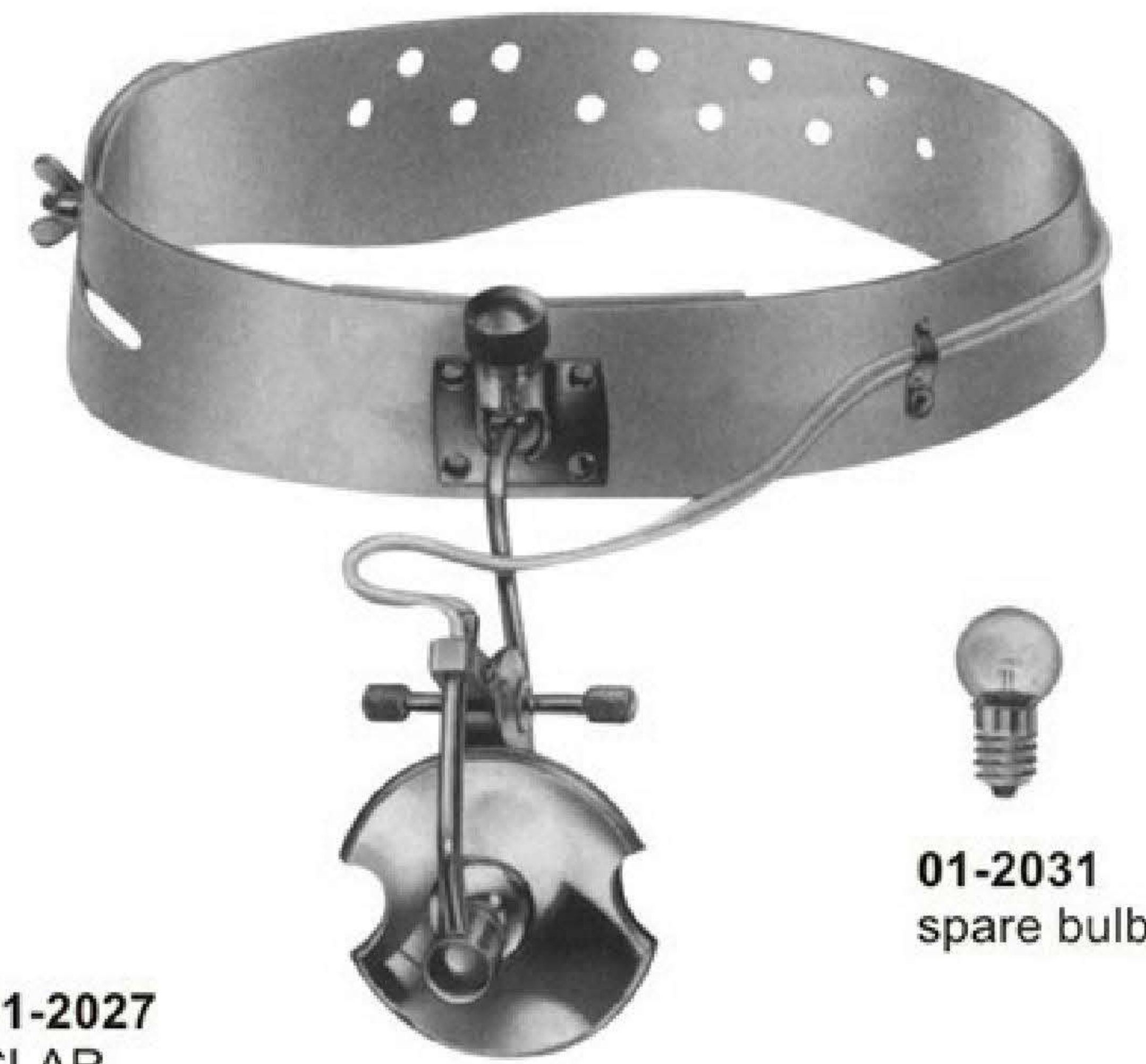

**01-2027**  
CLAR  
Head light, 6 volt, with adjustable joint, white celluloid head band, with foam rubber pad and cord with plugs for transformer

**01-2028**  
White celluloid head band, only, for head light

**01-2029**  
mirror only, for head light

**01-2030**  
spare foam rubber pad, for head band



**01-2032**  
JANSEN  
Head light, 6 volt, with adjustable joint, white plastic head band, cord with plugs for transformer



**01-2034**  
LANGENBECK  
Head light, 3.7 volt, with adjustable joint, white plastic head band, cord with plugs for transformer

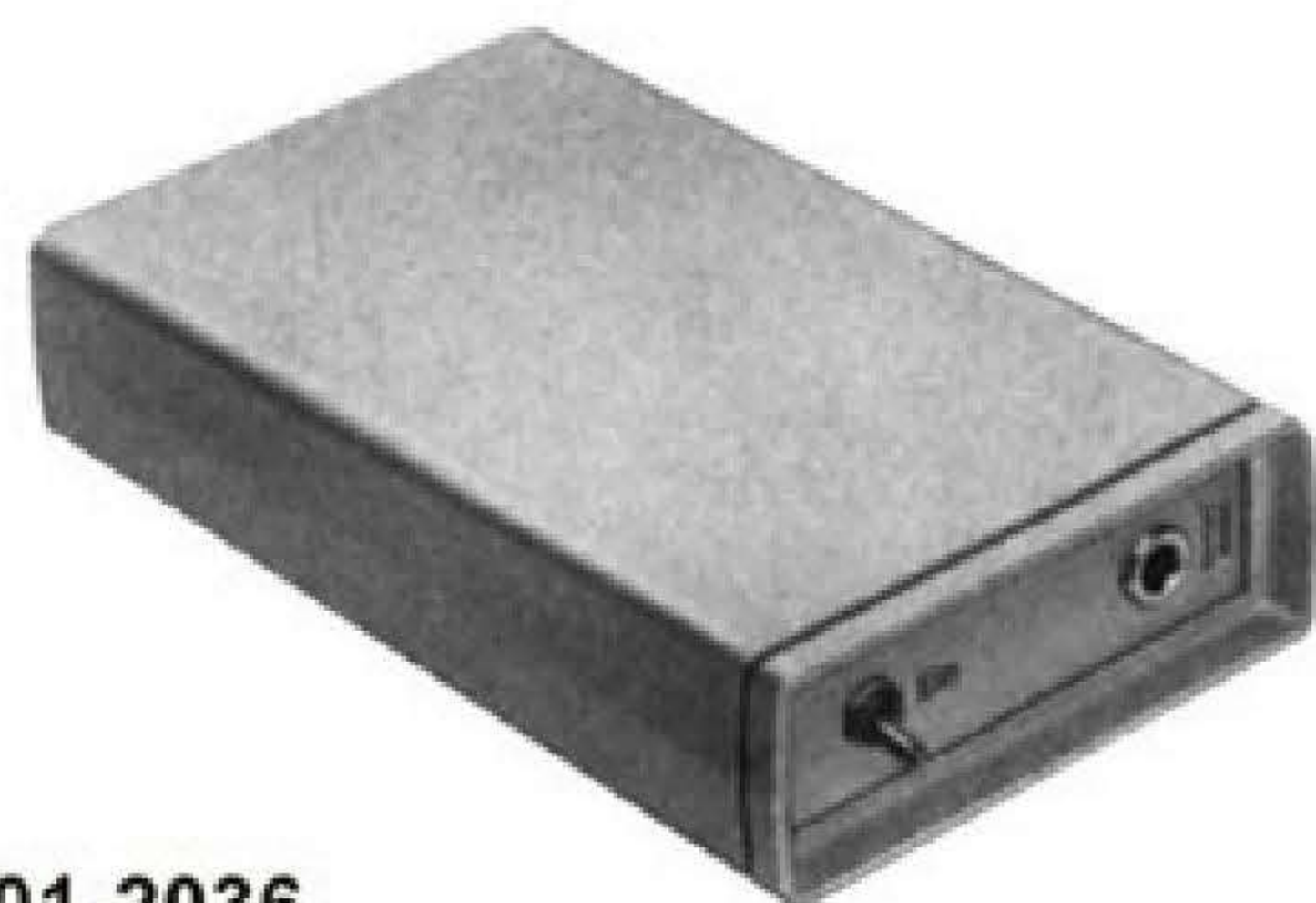

**01-2036**  
HERBERHOLD  
Pocket-Accu, 6 volts, with cord for head lights



**01-2037**  
Extension cord only, to connect the accu to the cord of the head lights



**01-2038**  
Charging Set for pocket accu **01-2036**  
mains current: 220-240 volts, 50-60 Hz



**01-2039**  
220 volt / 220 volts  
**01-2040**  
120 volt / 120 volts  
Transformer

# Tongue Depressors, Retractors

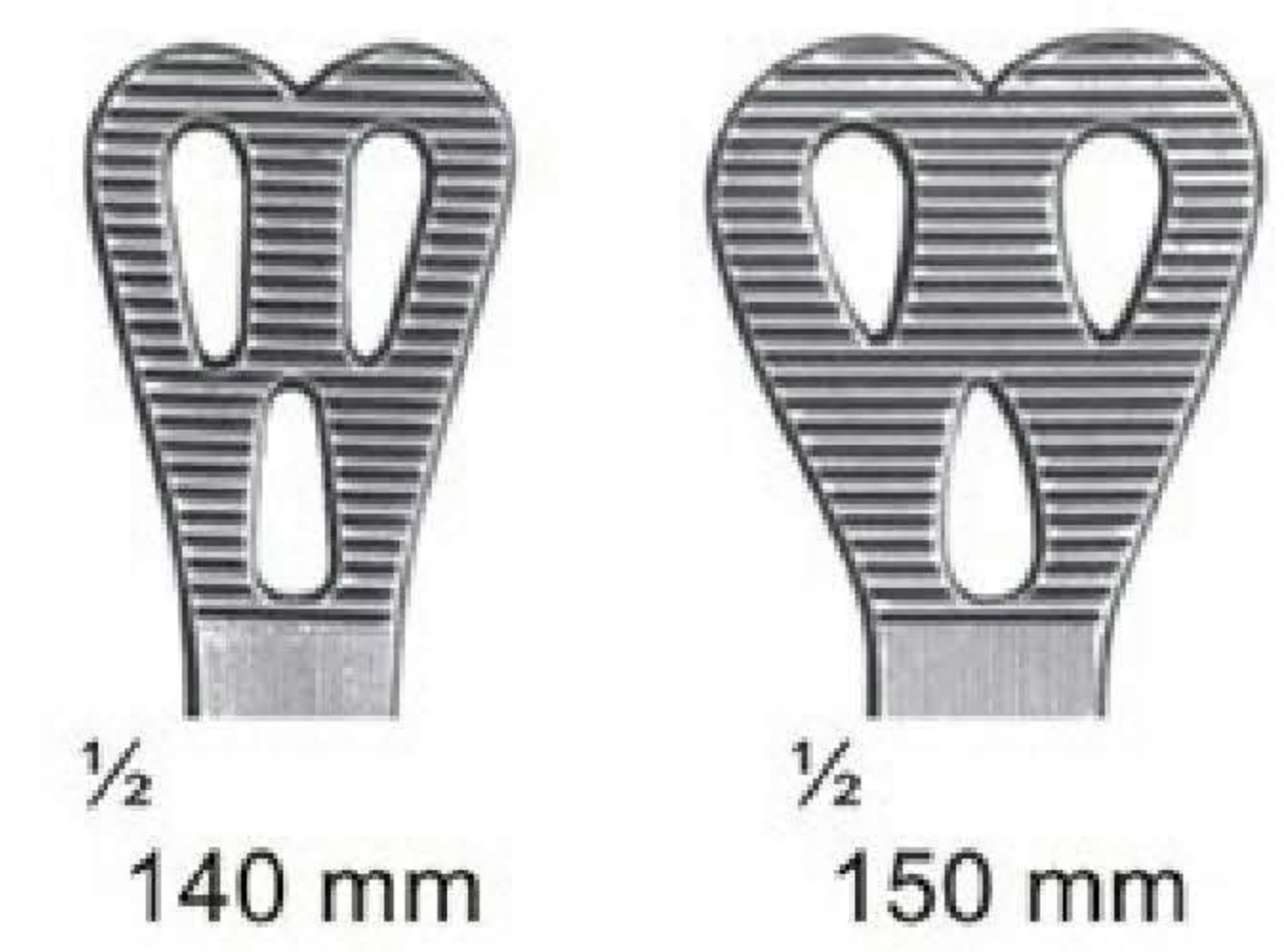
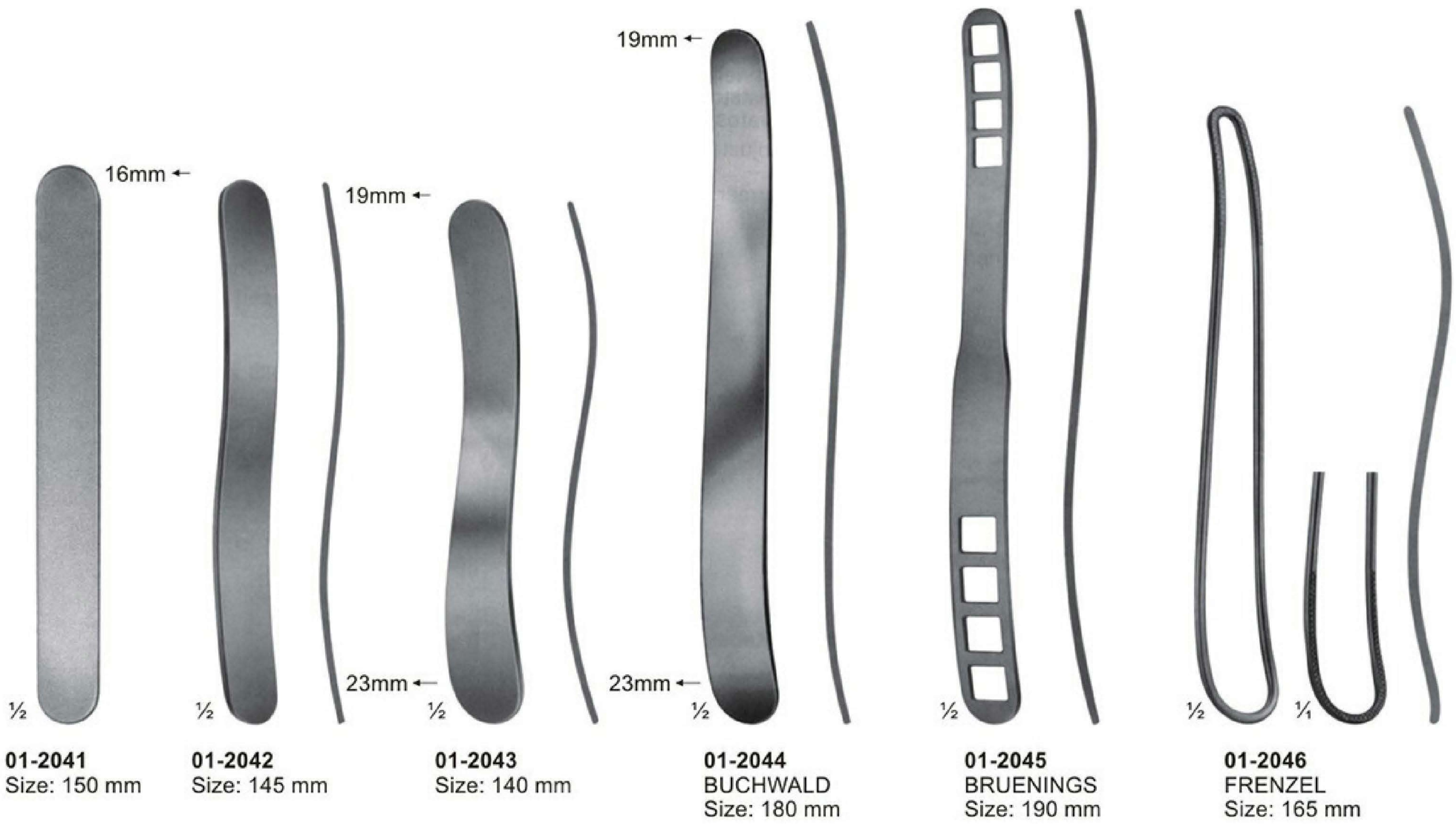

# Mouth Gags And Tongue Forceps



1/2  
**01-2055**  
SCHIMMELBUSCH  
Ether Mask



1/2  
**01-2056**  
HEISTER  
Mouth Gag  
Size: 130 mm



1/2  
**01-2057**  
FERGUSSON-ACKLAND  
Mouth Gag  
Size: 145 mm



1/2  
**01-2058**  
DENHARDT  
Mouth Gag With  
Silicon Inserts,  
Interchangeable  
Size: 125 mm



1/2  
**01-2059-01-2060**  
ROSER KOENIG  
Mouth Gag  
Size: **01-2059** 160mm  
**01-2060** 185mm



1/2  
**01-2061**  
YOUNG  
Size: 165 mm



1/4  
**01-2062**  
1 Pair Of  
Rubber Pads

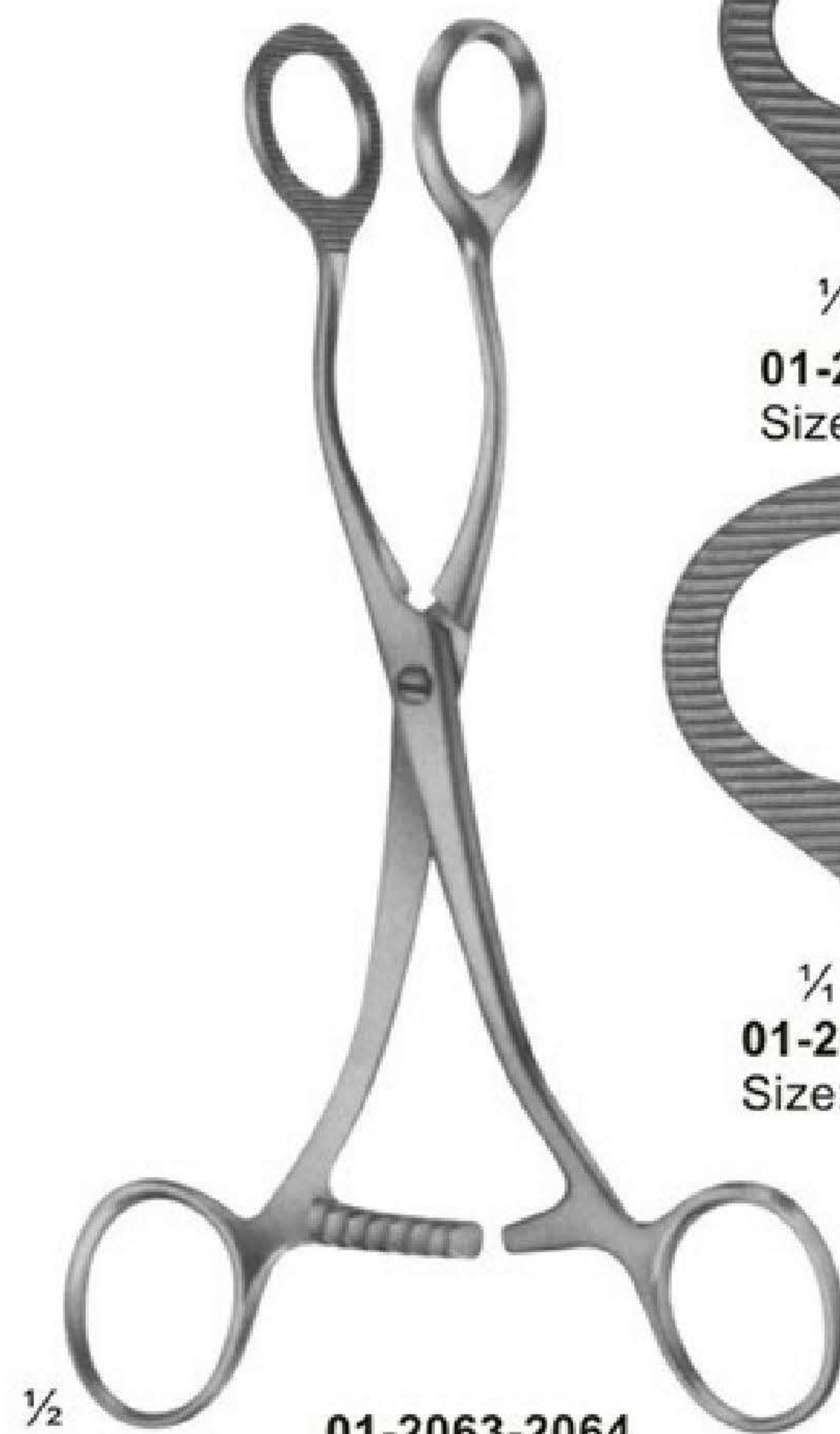

1/2  
**01-2063-2064**  
COLLIN



1/4  
**01-2063**  
Size: 160 mm



1/4  
**01-2064**  
Size: 170 mm

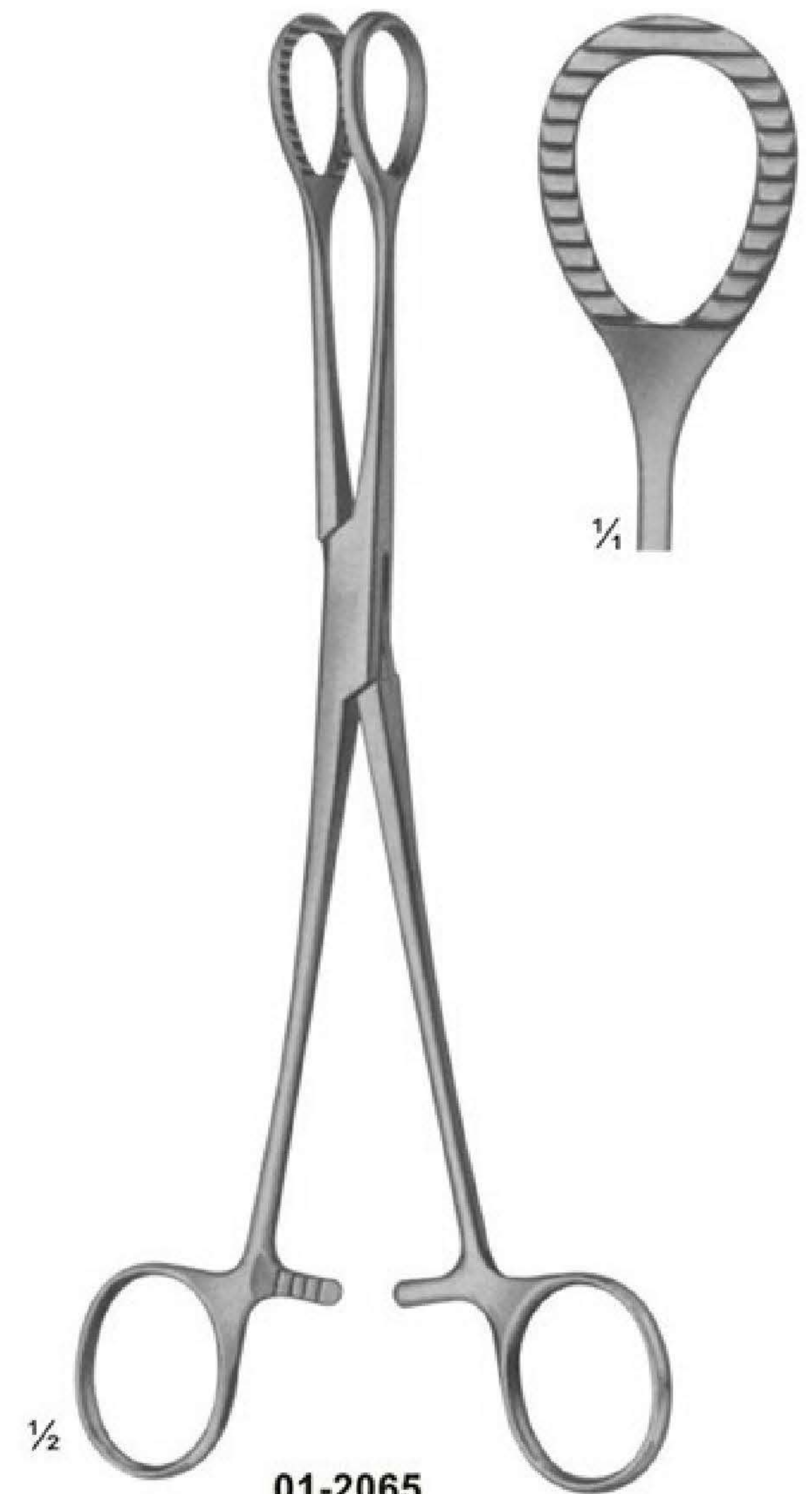

1/2  
**01-2065**  
HEYWOOD-SMITH modif.  
Size: 215 mm

# Blood Lancets & Laryngeal Mirrors



01-2067  
Ø 12 mm  
Spare Mirrors Only



01-2068  
Ø 14 mm  
Spare Mirrors Only

1/2

01-2066  
MICHEL  
Rhinoscopic Mirrors  
With Interchangeable  
Mirror Inserts  
Size: 250 mm



1/2

01-2069  
Mirror Handle  
Size: 110 mm

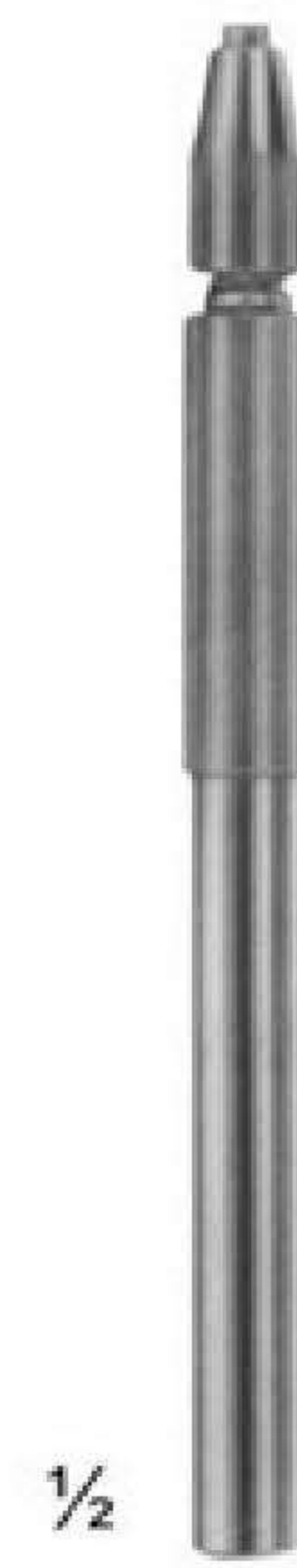

1/2

01-2070  
Mirror Handle  
Size: 105 mm

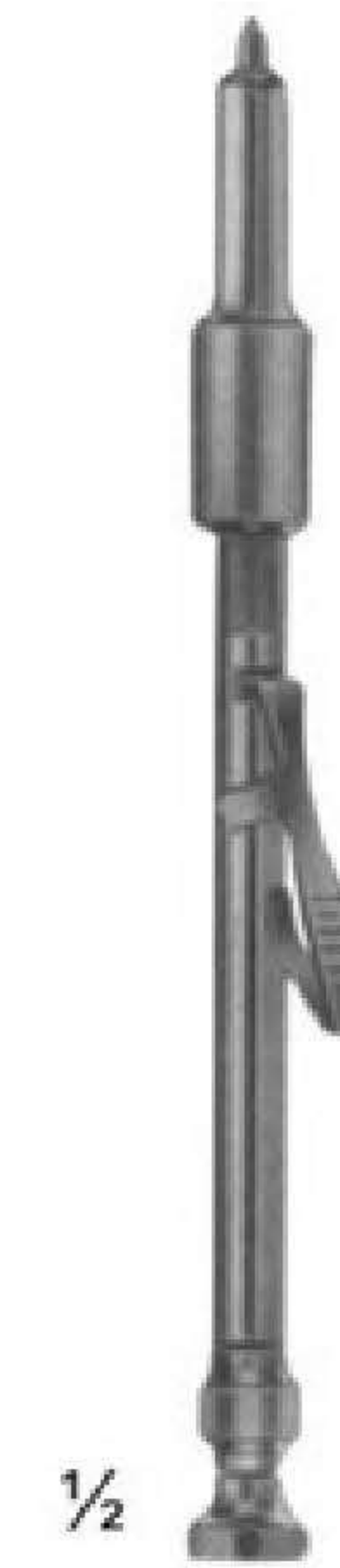

1/2

01-2071  
FRANCKE  
Automatic  
Blood Lancet



01-2072  
KOLLE  
Microscopic  
Needle Holder  
With Plastic  
Handle  
Size: 240 mm



1/2

01-2073  
Laryngeal Mirrors With  
Hexagonal Handle  
Size: 180 mm

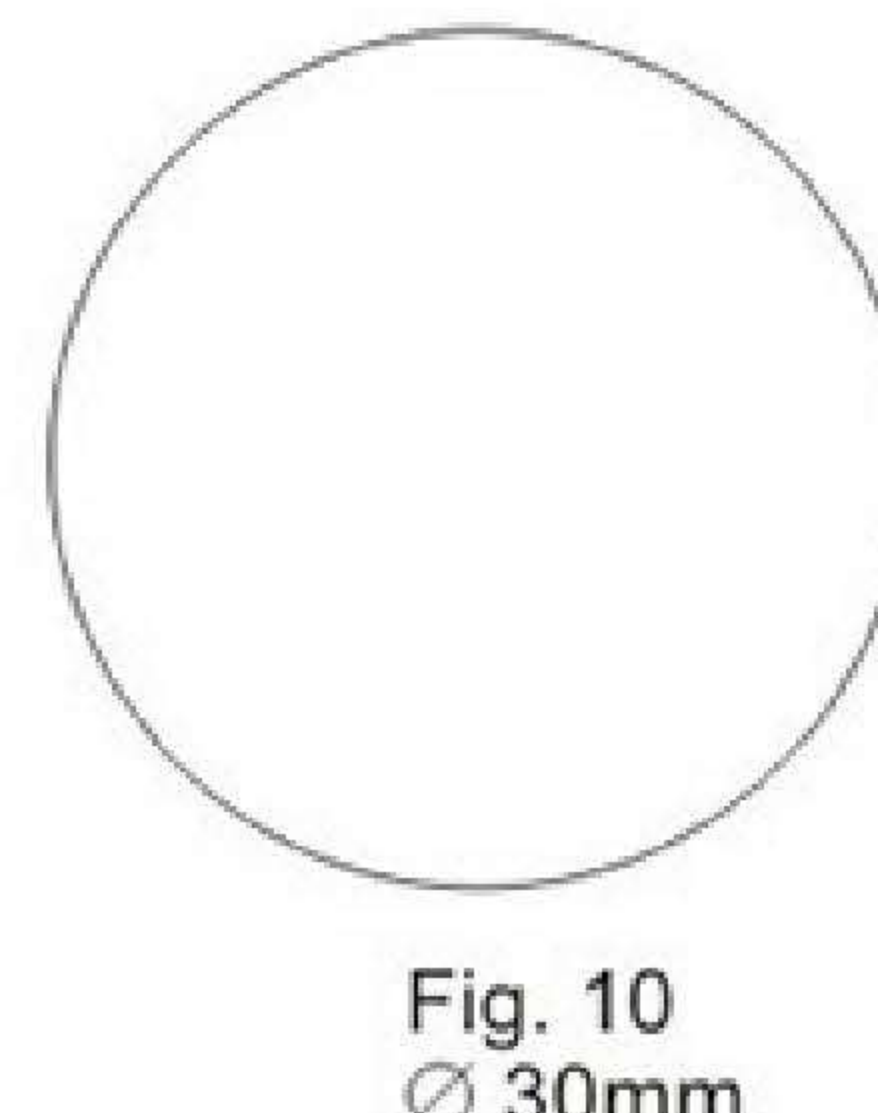
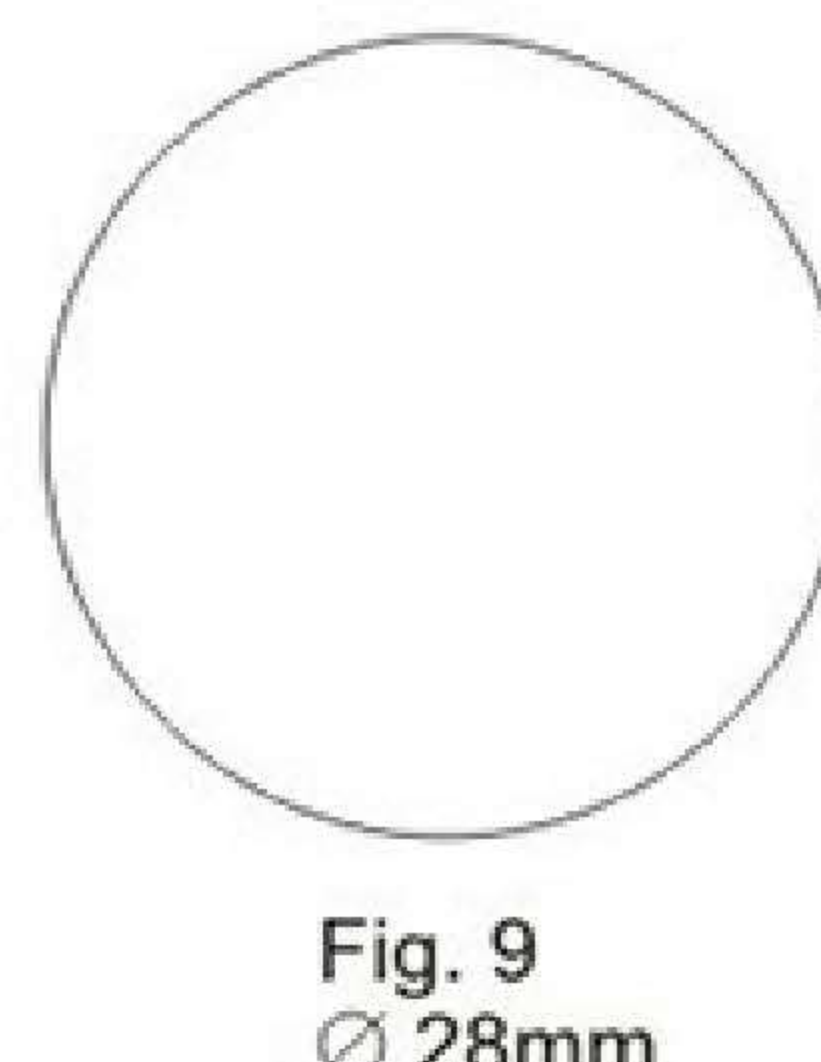
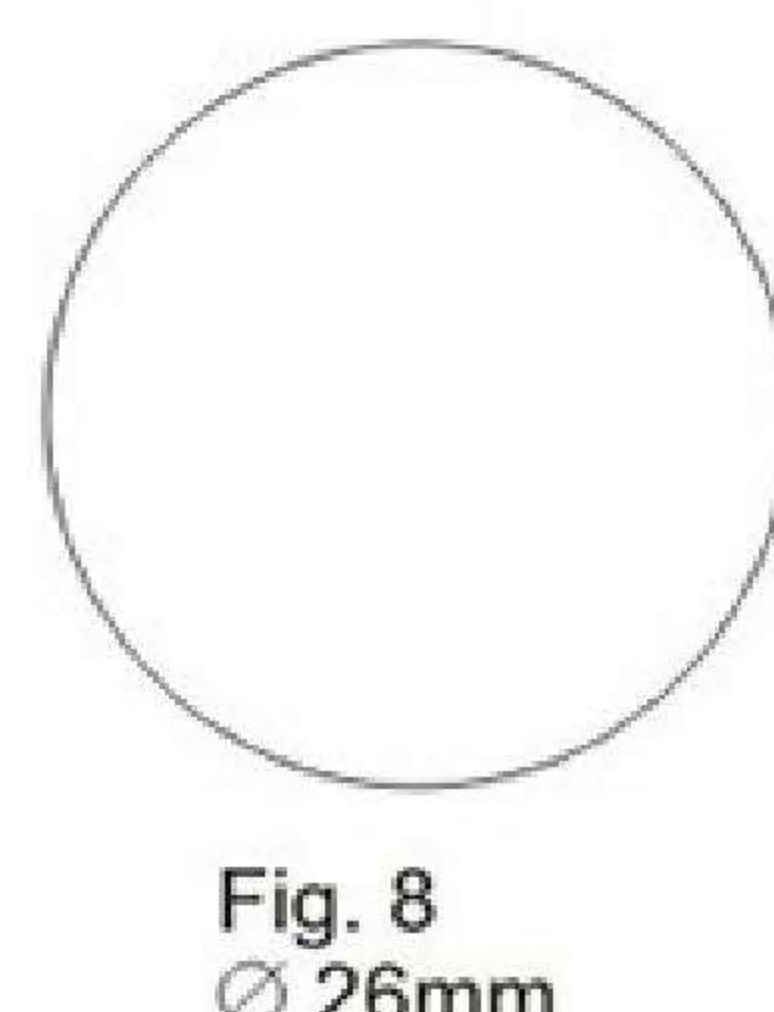
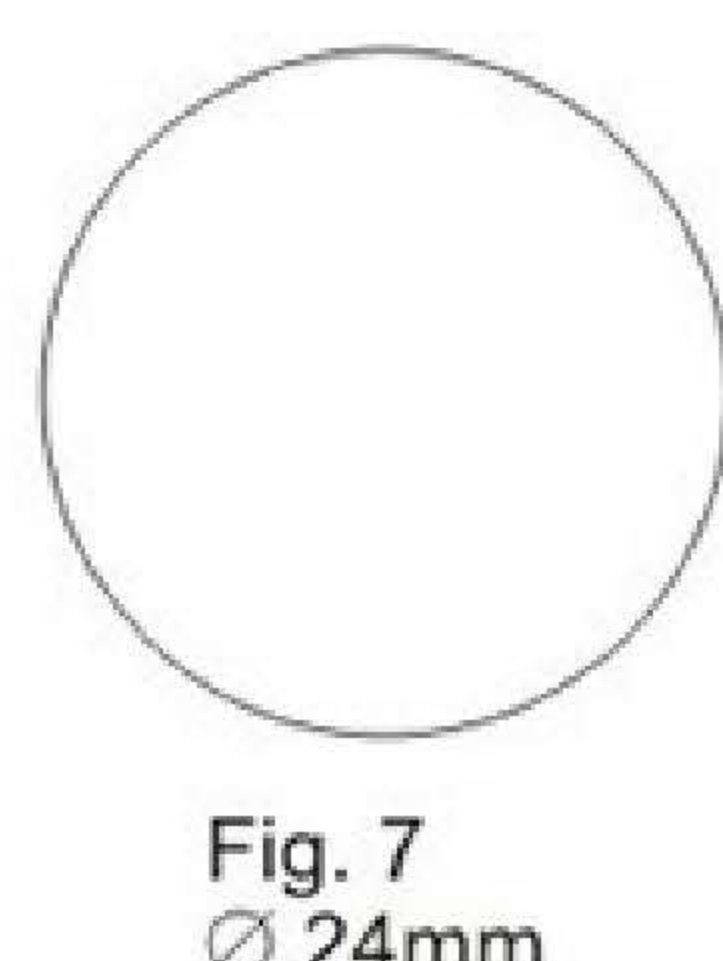
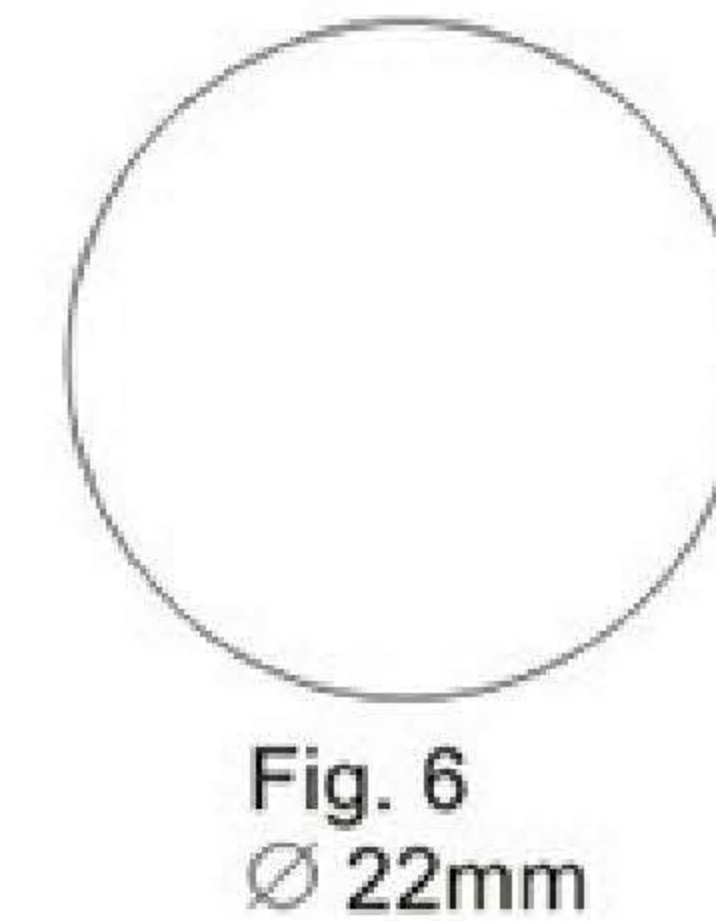
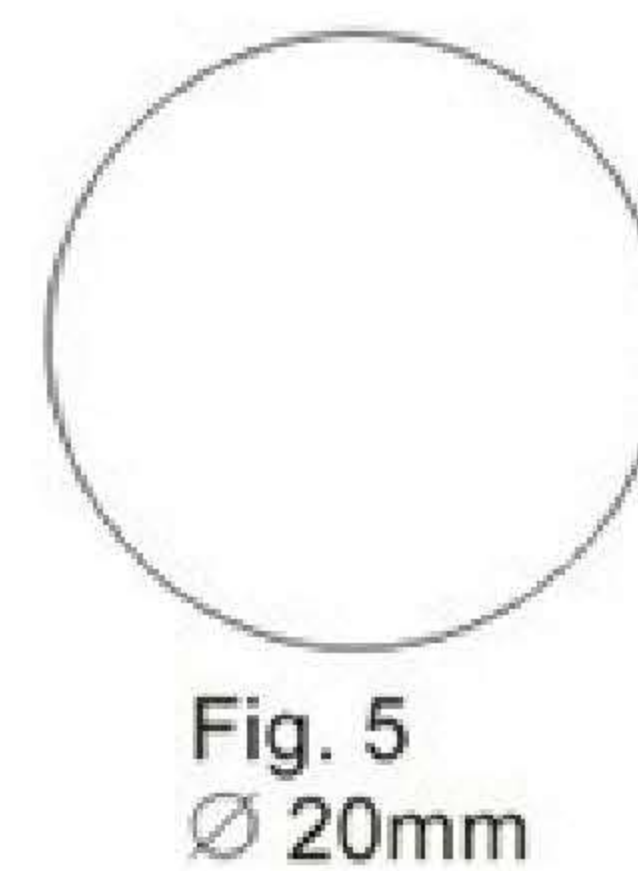
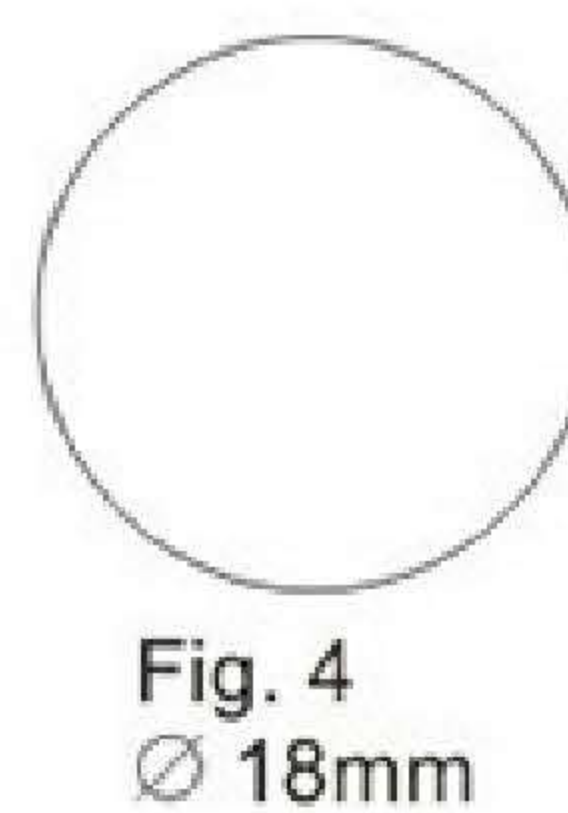
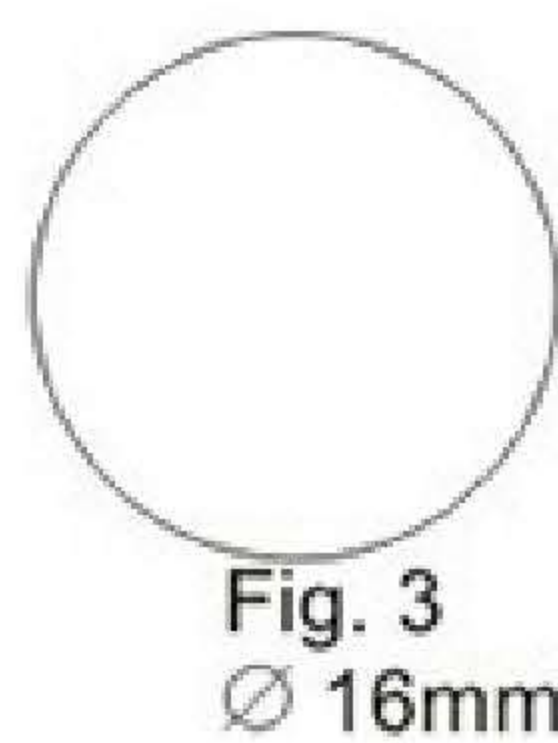
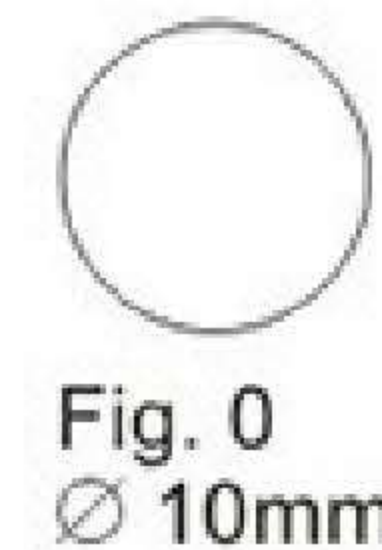

## Diagnostic Sets



1/2

**01-2074 - 01-2076**  
MAGILL  
Catheter Introducing  
Forceps



**01-2074**  
Infants  
Size: 150 mm



**01-2075**  
Children  
Size: 200 mm



**01-2076**  
Adults  
Size: 250 mm

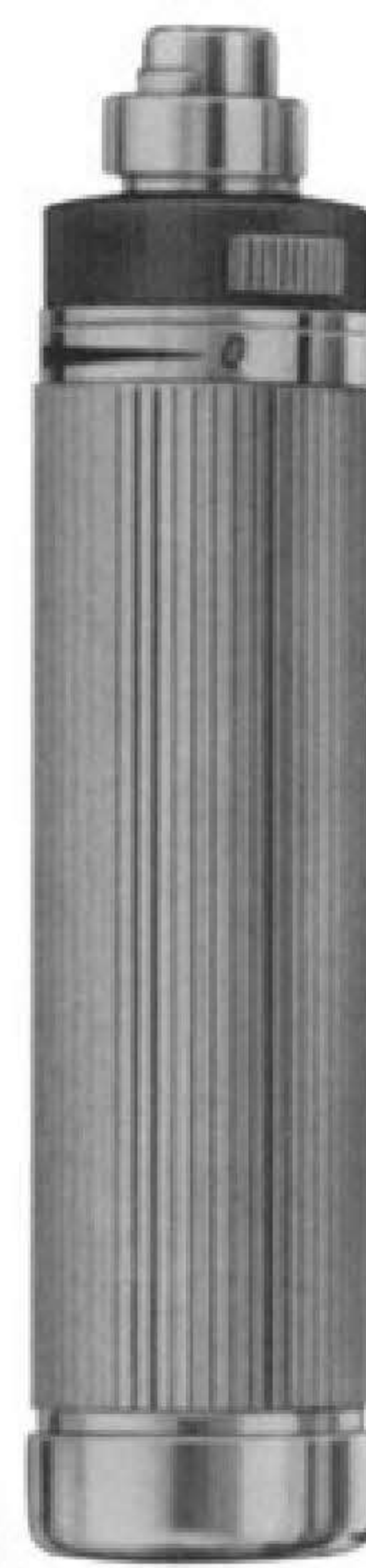

1/2

**01-2077**  
Medium battery handle  
only, 25 mm diam.

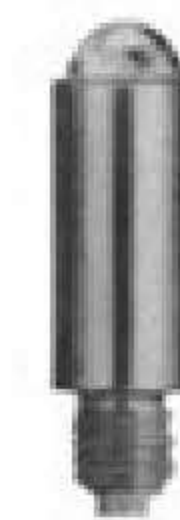

**01-2078**  
Spare bulb  
2.7 volt, for  
Otoscopes etc.



**01-2079**  
Spare bulb  
2.6 volt, for  
ophthalmoscopes



**01-2080**  
Otoscope Set, Consists Of  
Battery Handle Without Batteries,  
3 Ear Specula, 1 Bulb In Velvet Lined Case



**01-2081**  
Diagnostic Set, Otoscope With Three Specula,  
Nasal Speculum, Lamp Holder, Two Laryngeal  
Mirrors, Tongue Blade Holder



# Laryngoscopes



**01-2082**  
**MILLER**  
Laryngoscope Set, Consists Of Battery Handle ( Without Battery )  
With Five Miller Laryngoscope Blades, Fig 1 to 5

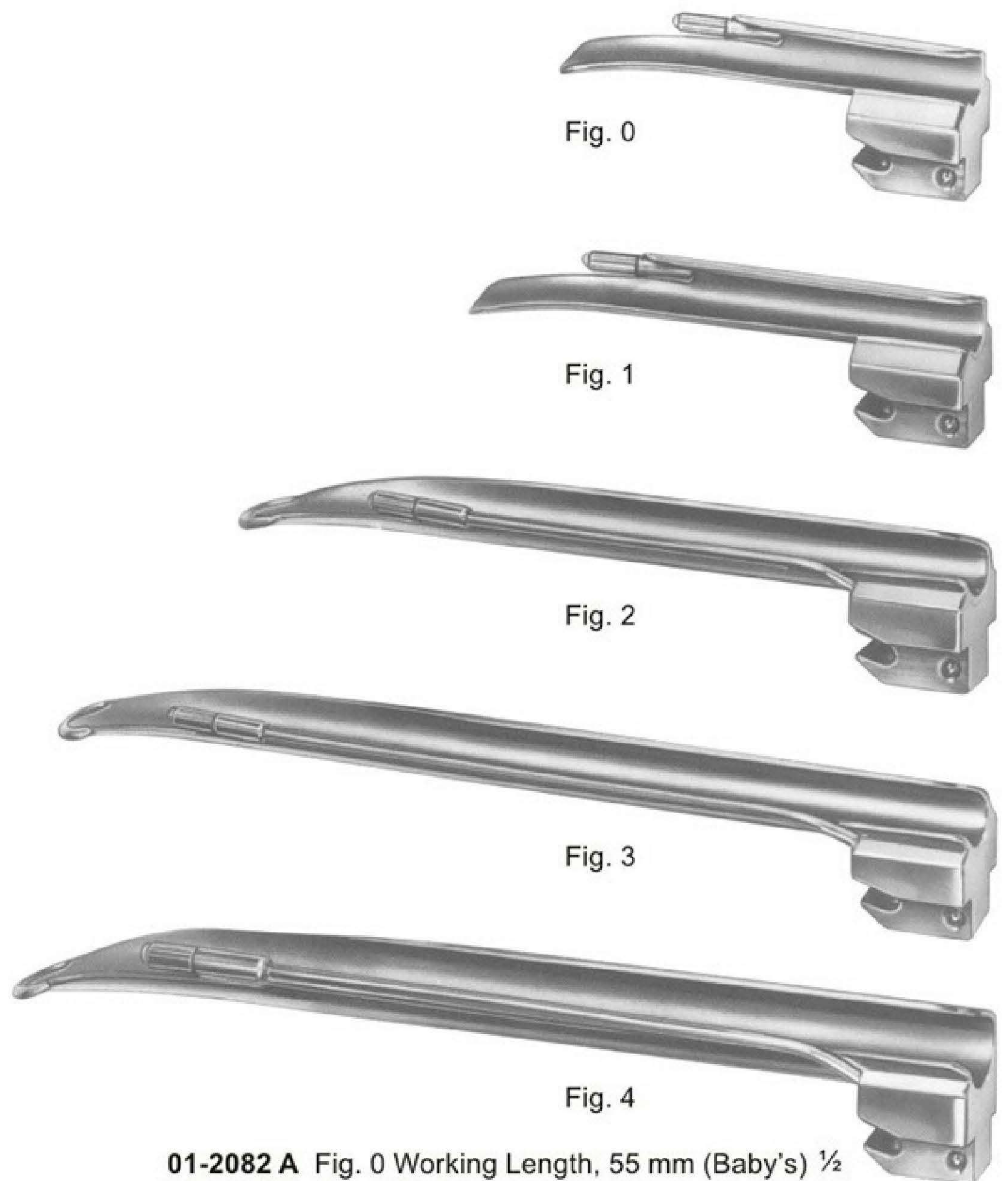

**01-2082 A** Fig. 0 Working Length, 55 mm (Baby's)  $\frac{1}{2}$   
**01-2082 B** Fig. 1 Working Length, 80 mm (Children's)  
**01-2082 C** Fig. 2 Working Length, 130 mm (Adolescent's)  
**01-2082 D** Fig. 3 Working Length, 170 mm (Women's)  
**01-2082 E** Fig. 4 Working Length, 180 mm (Men's)



**01-2083**  
**GUEDEL-NEGUS**  
Laryngoscope Set, Consists Of Battery Handle ( Without Battery )  
With Four Miller Laryngoscope Blades

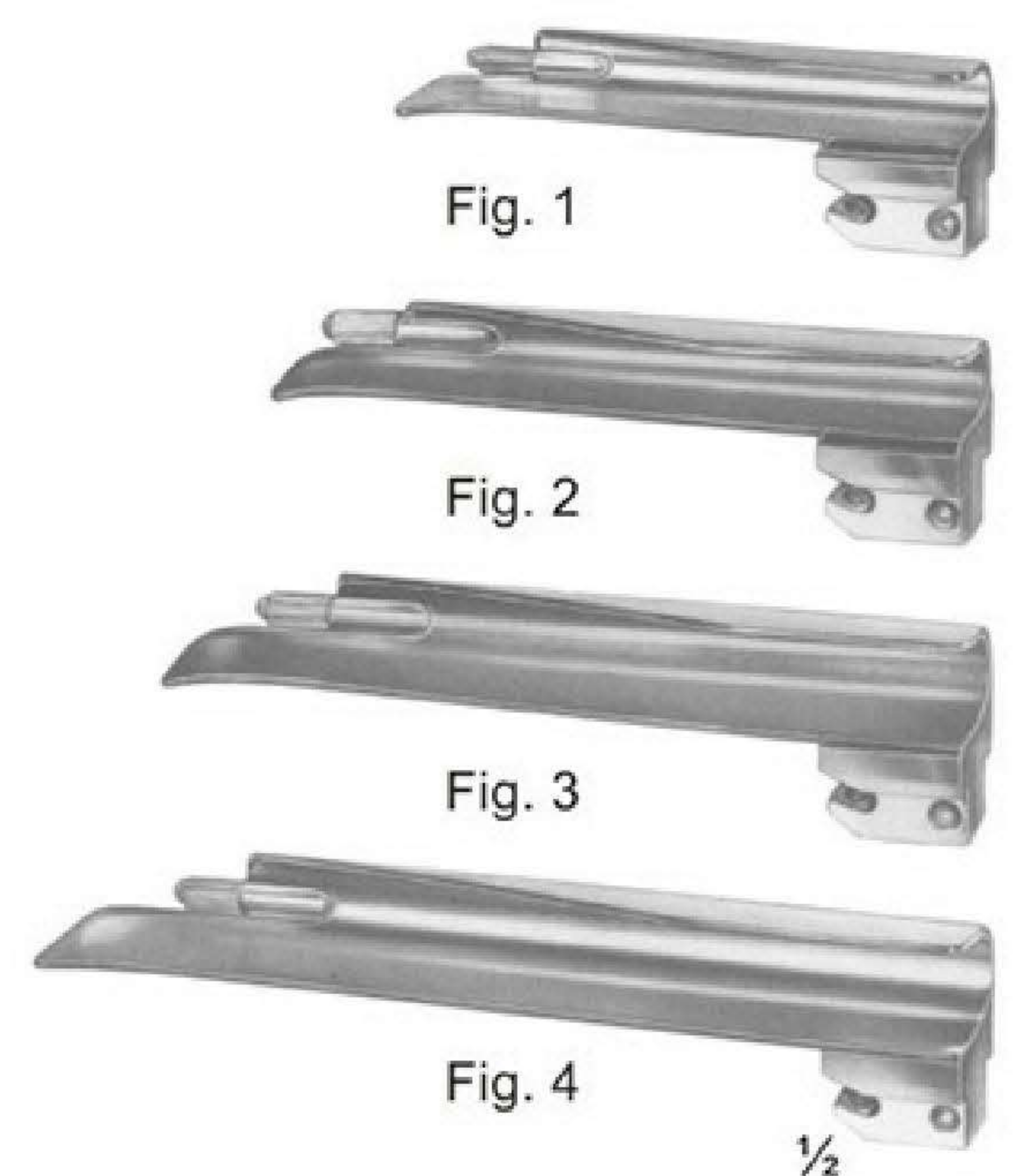

**01-2083 A** Fig. 1 Working Length, 70 mm (Children's)  
**01-2083 B** Fig. 2 Working Length, 90 mm (Adolescent's)  
**01-2083 C** Fig. 3 Working Length, 110 mm (Women's)  
**01-2083 D** Fig. 4 Working Length, 135 mm (Men's)

# Laryngoscopes



**01-2084**  
McINTOSH  
Laryngoscope Set, Consists Of Battery Handle ( Without Battery )  
With Three McIntosh Blades, Fig. 1, Fig. 2, Fig. 3

**01-2085**  
McINTOSH  
Laryngoscope Set, Consists Of Battery Handle ( Without Battery )  
With Five McIntosh Blades, Fig. 0, Fig. 1, Fig. 2, Fig. 3, Fig. 4



**01-2086**  
FOREGGER  
Laryngoscope Set, Consists Of  
Battery Handle ( Without Battery )  
With Three Foregger Blades,  
Fig. 1, Fig. 2, Fig. 3,

**01-2087**  
FOREGGER  
Laryngoscope Set, Consists Of  
Battery Handle ( Without Battery )  
With Four Foregger Blades,  
Fig. 1, Fig. 2, Fig. 3, Fig. 4,

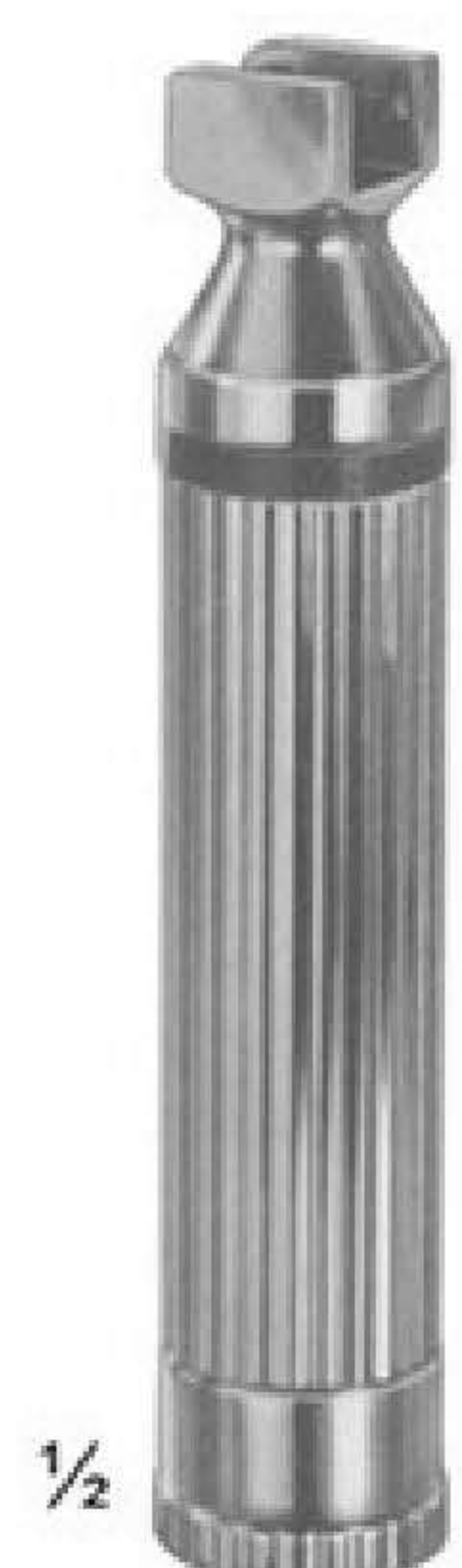

**01-2088**  
Fiber Optic  
Battery Handle  
30mm diam.

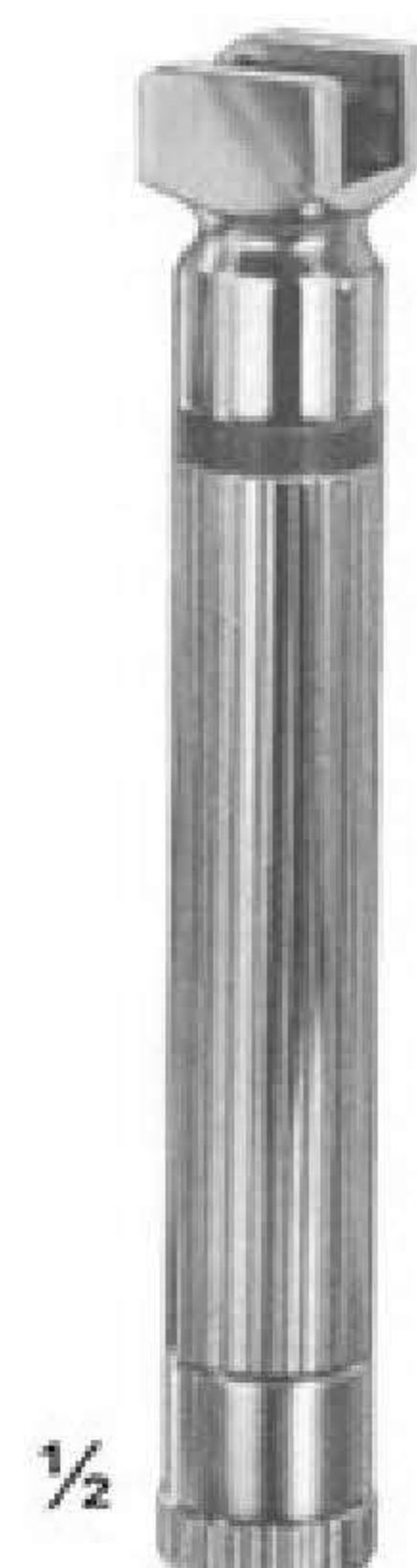

**01-2089**  
Fiber Optic  
Battery Handle  
18mm diam.



**01-2090**  
Replacement Lamp  
( Krypton ) 2.5 V

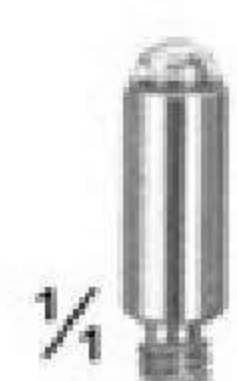

**01-2091**  
Replacement Lamp  
( Halogen ) 2.5 V



Fig. 0



Fig. 1

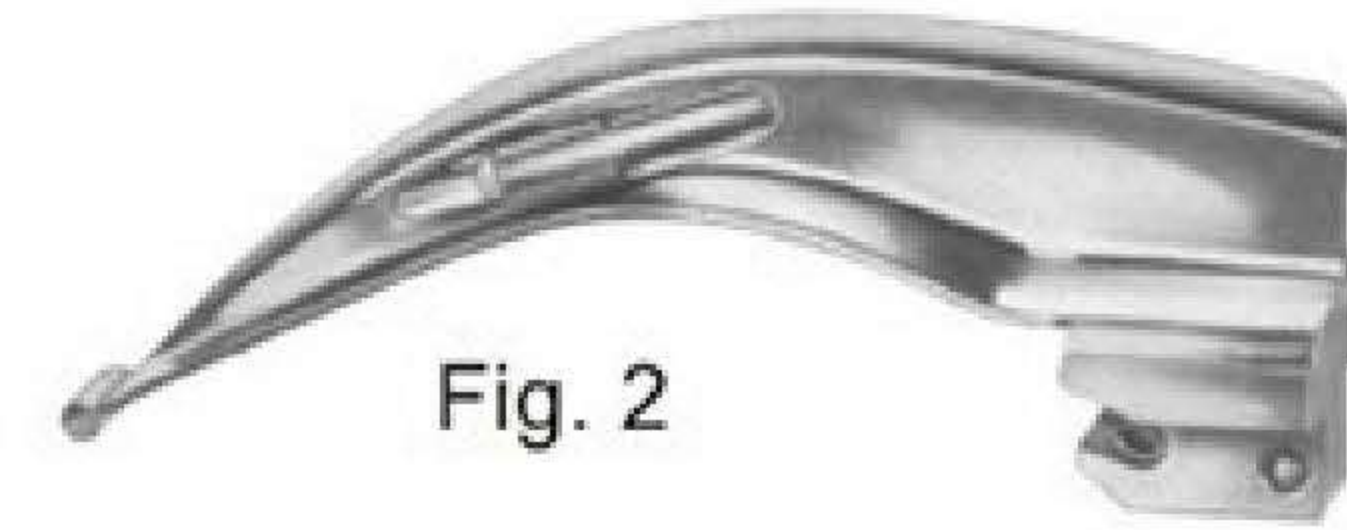

Fig. 2



Fig. 3



Fig. 4

**01-2085 A** Fig. 0 Working Length, 55 mm (Baby's)  
**01-2085 B** Fig. 1 Working Length, 75 mm (Children's)  
**01-2085 C** Fig. 2 Working Length, 90 mm (Adolescent's)  
**01-2085 D** Fig. 3 Working Length, 110 mm (Women's)  
**01-2085 E** Fig. 4 Working Length, 135 mm (Men's)



Fig. 1



Fig. 2



Fig. 3

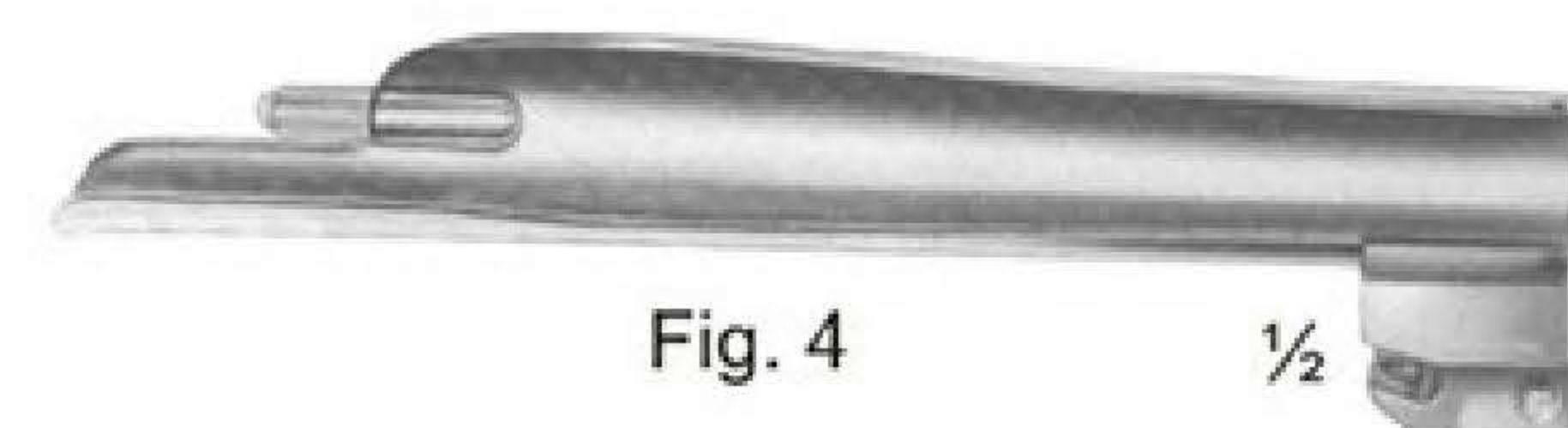

Fig. 4

**01-2086 A** Fig. 1 Working Length, 70 mm (Children's)  
**01-2086 B** Fig. 2 Working Length, 90 mm (Adolescent's)  
**01-2086 C** Fig. 3 Working Length, 110 mm (Women's)  
**01-2086 D** Fig. 4 Working Length, 135 mm (Men's)

# Examination & Measuring Instruments



**01-2092**  
Caliper Of Aluminium  
Graduated in mm & inches  
up to 180mm  
Measuring Range up to 139mm



**01-2093**  
VERNIER  
Universal Caliper Of Steel  
Graduated in mm & inches  
up to 180mm  
Measuring Range up to 120mm  
with Vernier in 1/10mm & 1/16"

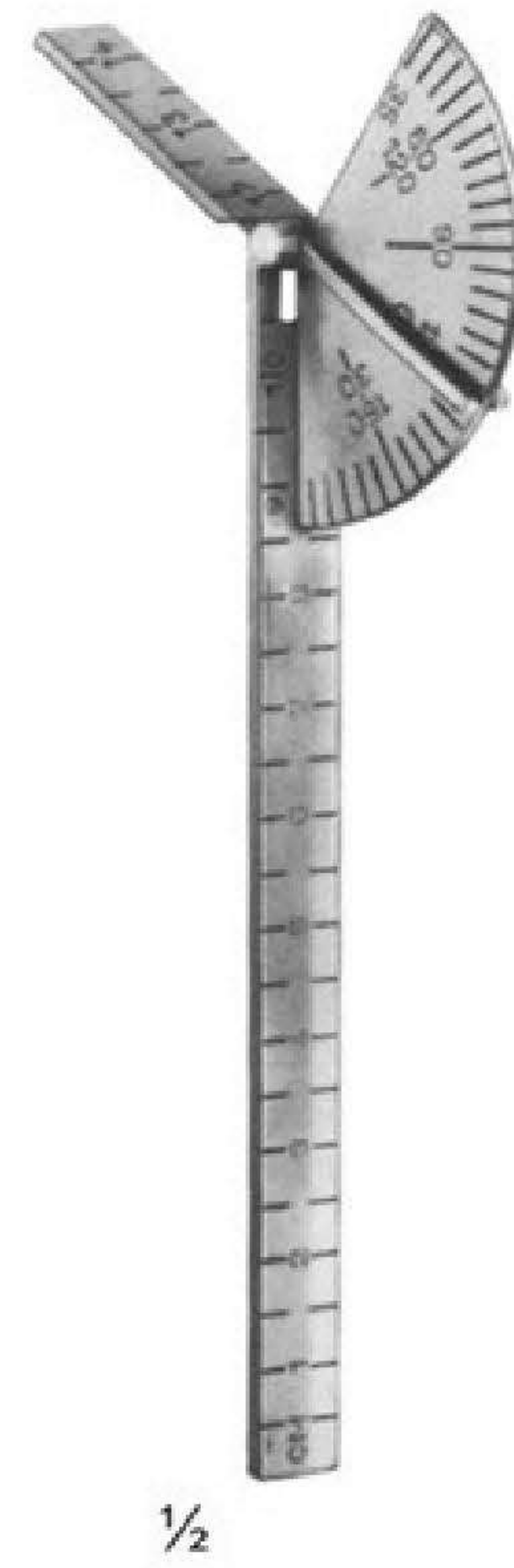

**01-2094**  
CARROLL  
Size: 145 mm  
Finger Goniometer



**01-2095**  
TOWNLEY  
Graduated in  
mm & inches  
Size: 115 mm

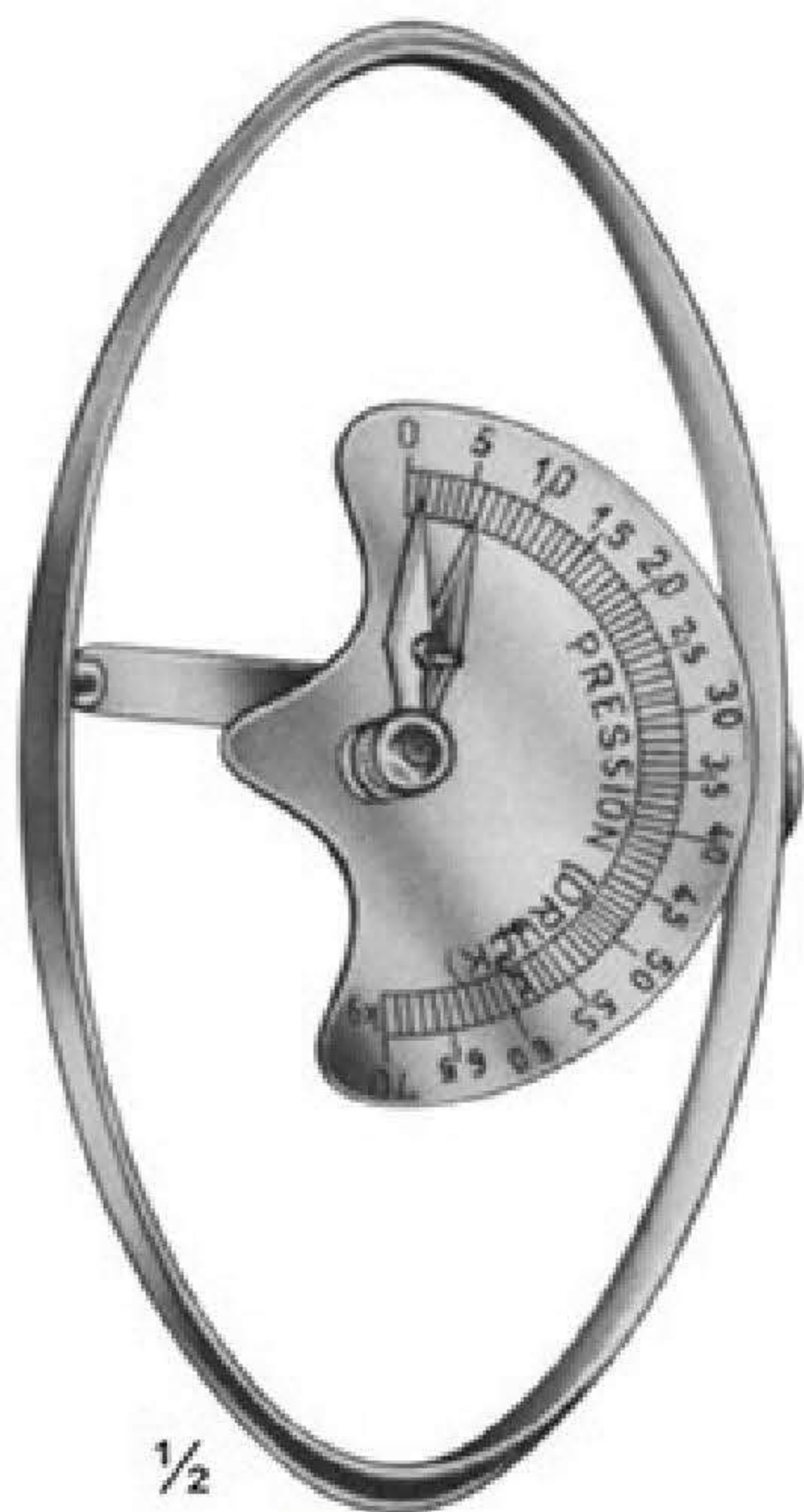

**01-2096**  
COLLIN  
Druck Pressure 72 kg  
Size: 125 mm



**01-2097**  
BERTILLON  
Caliper For Measuring The Head  
Size: 320 mm



**01-2098**  
CASTROVIEJO  
Caliper  
Size: 75mm



**01-2099**  
MOLTGEN  
Goniometer

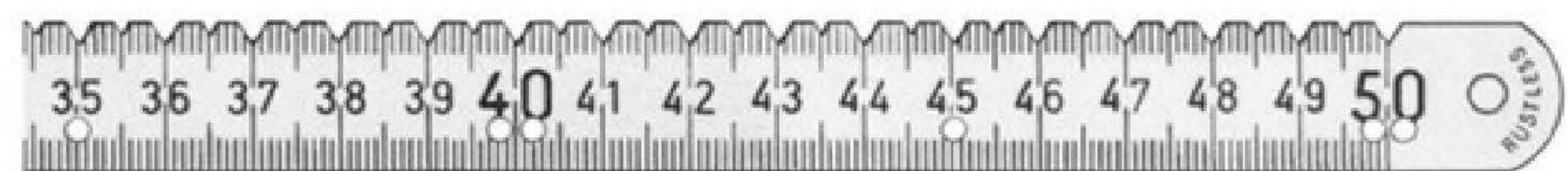
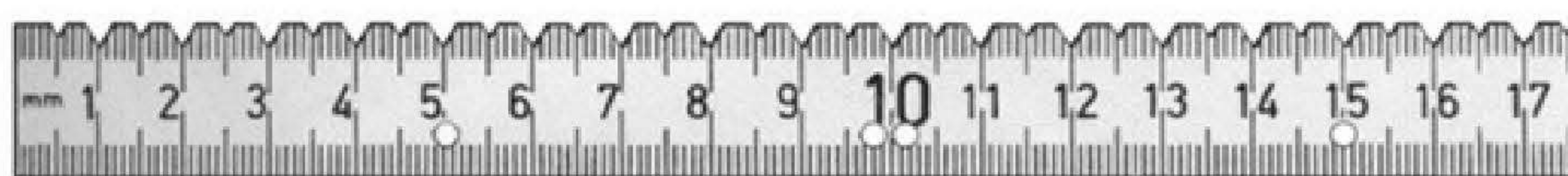

**01-2100A**  
Size: 150 mm

**01-2100**  
Size: 500 mm

# Dissecting Knives



**01-2101 - 01-2110**  
Fig. 1 - 10  
With Metal Handle



**01-2101**  
Fig. 1  
Size: 30mm  
15cm

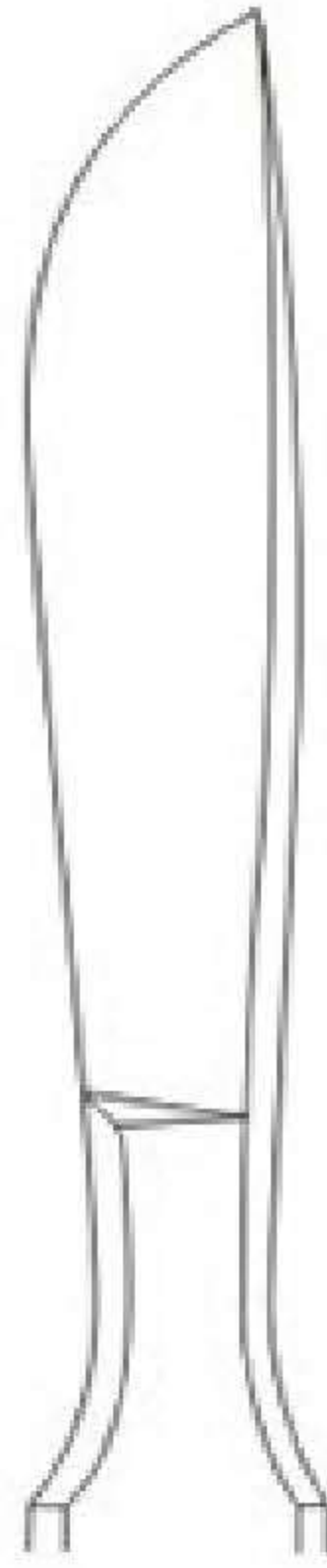

**01-2102**  
Fig. 2  
Size: 36mm  
15cm

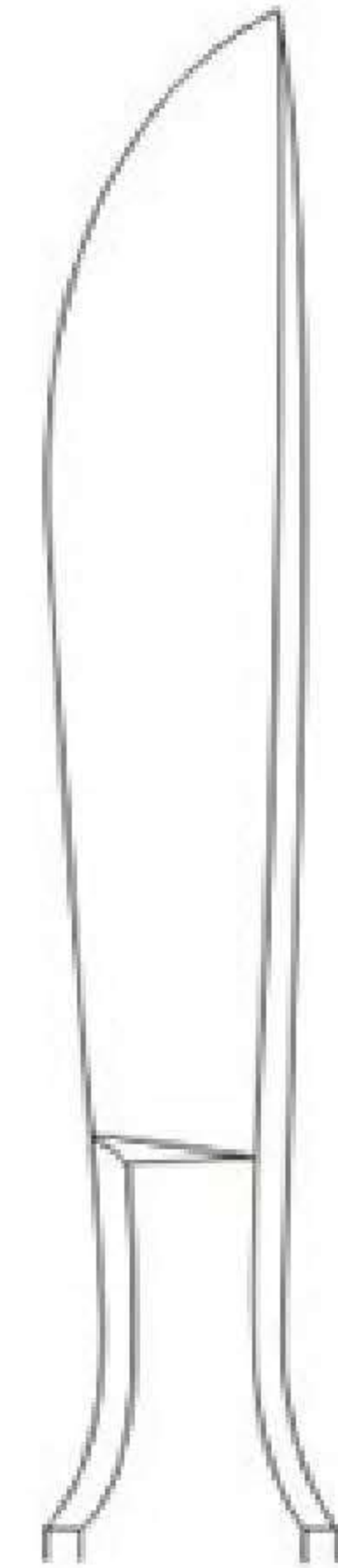

**01-2103**  
Fig. 3  
Size: 40mm  
15.5cm

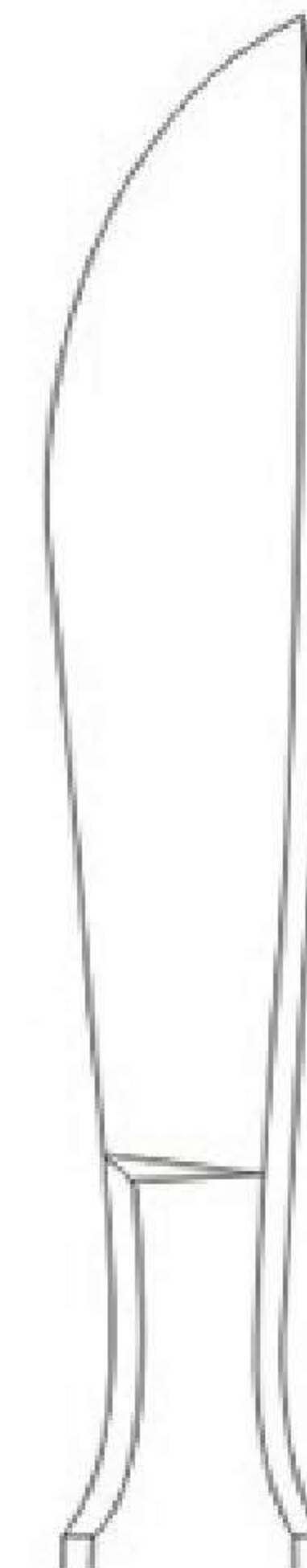

**01-2104**  
Fig. 4  
Size: 45mm  
16cm

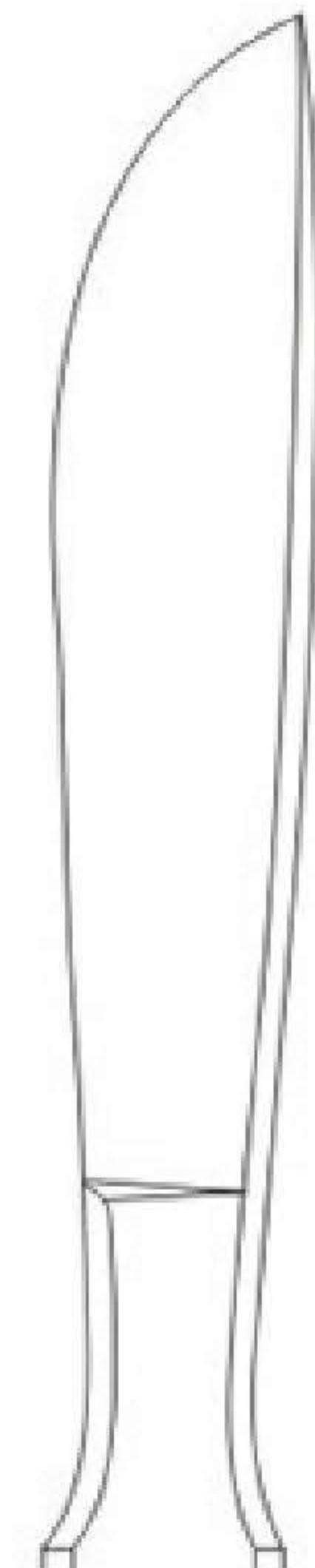

**01-2105**  
Fig. 5  
Size: 50mm  
16cm



**01-2106**  
Fig. 6  
Size: 27mm  
15cm

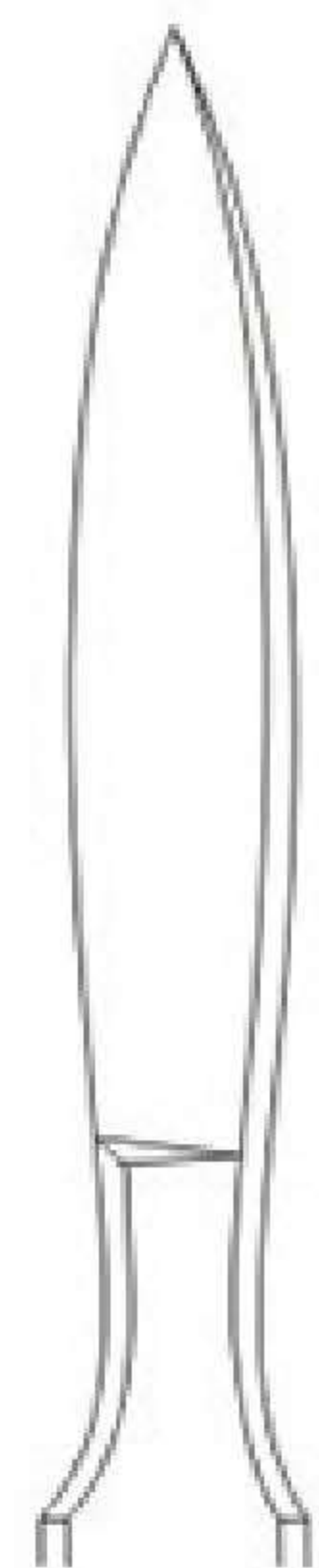

**01-2107**  
Fig. 7  
Size: 35mm  
15cm

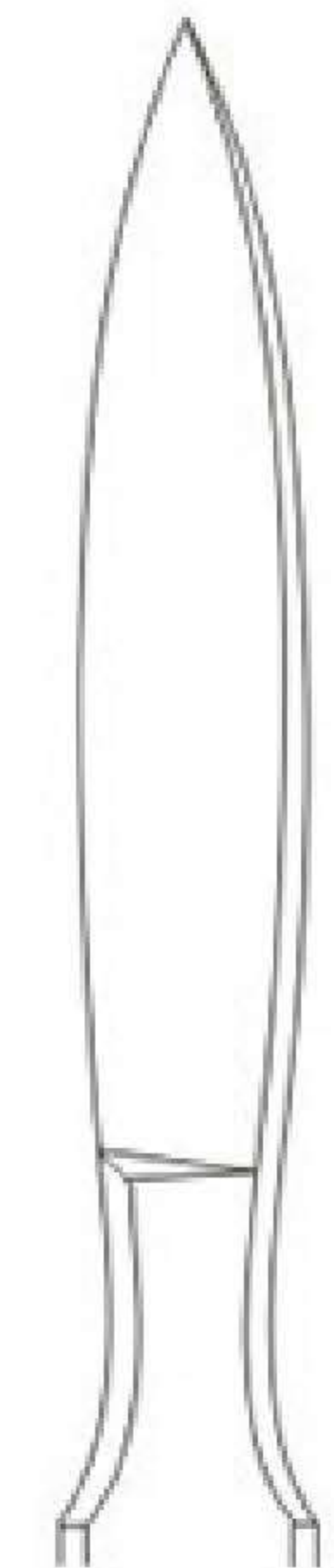

**01-2108**  
Fig. 8  
Size: 40mm  
16cm



**01-2109**  
Fig. 9  
Size: 47mm  
16cm

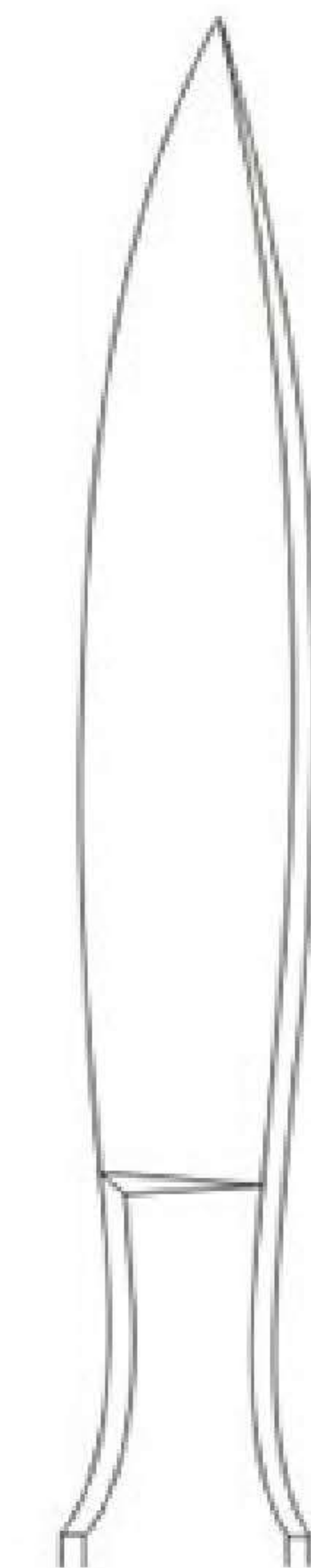

**01-2110**  
Fig. 10  
Size: 50mm  
17cm

# Autopsy & Cartilage Knives



$\frac{1}{2}$   
**01-2111**  
 Size: 255 mm  
 wooden handle.

**01-2112**  
 210mm  
 with wooden handle

**01-2113 - 01-2115**  
 WALB  
 with wooden handle

**01-2116 - 01-2118**  
 VIRCHOW  
 with hollow handle

$\frac{1}{4}$   
 Size: 100 mm

$\frac{1}{4}$   
 Size: 80 mm

**01-2113**  
 26cm  
 110mm

**01-2114**  
 29cm  
 140mm

$\frac{1}{2}$   
**01-2115**  
 31cm  
 170mm

**01-2116**  
 26cm  
 160mm

**01-2117**  
 33.5cm  
 200mm

$\frac{1}{2}$   
**01-2118**  
 38cm  
 240mm

# Scalpels, Tenotomes & Resection Knives

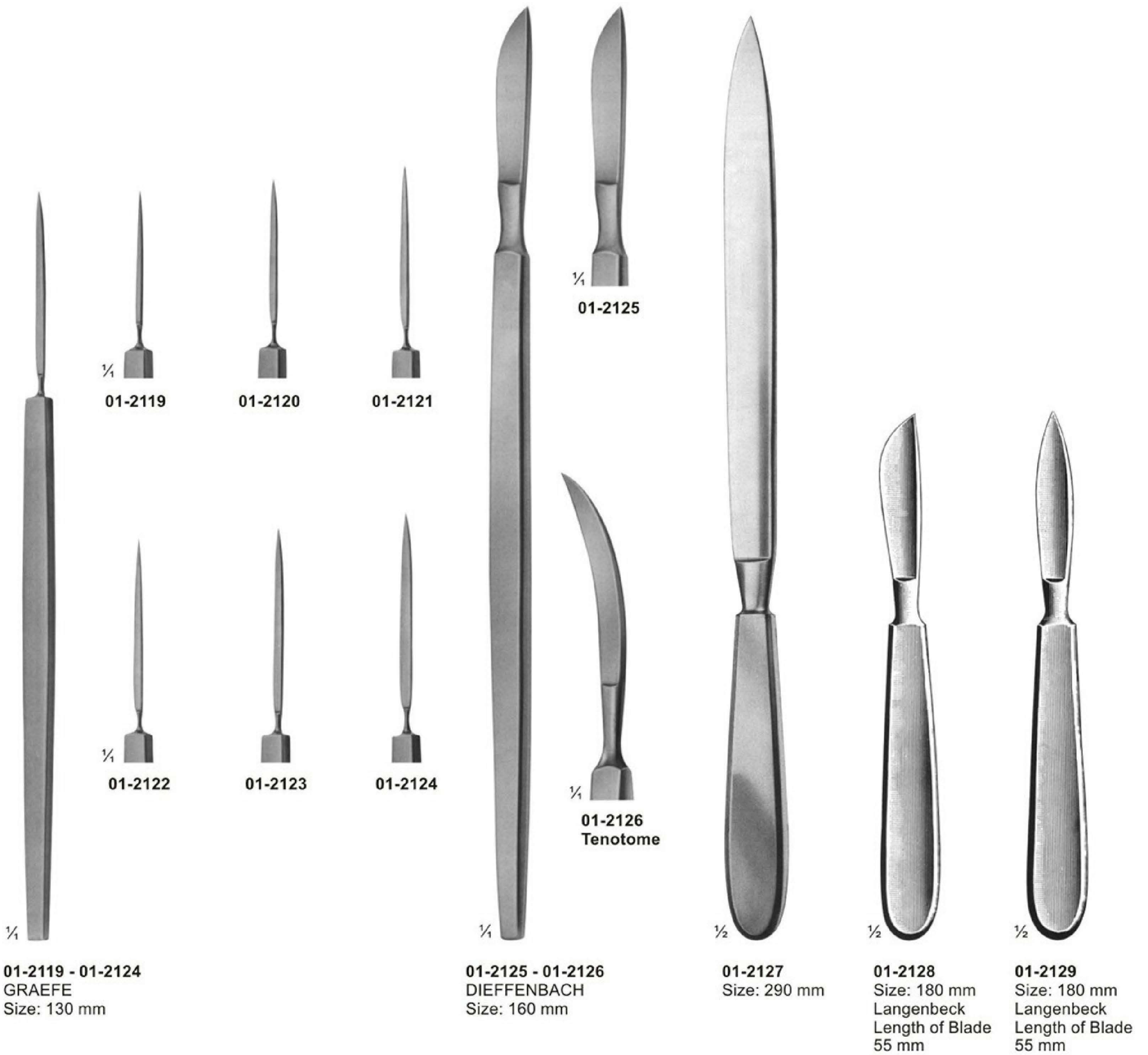

**01-2119 - 01-2124**  
 GRAEFE  
 Size: 130 mm

**01-2125 - 01-2126**  
 DIEFFENBACH  
 Size: 160 mm

**01-2127**  
 Size: 290 mm

**01-2128**  
 Size: 180 mm  
 Langenbeck  
 Length of Blade  
 55 mm

**01-2129**  
 Size: 180 mm  
 Langenbeck  
 Length of Blade  
 55 mm

# Scalpels, Tenotomes

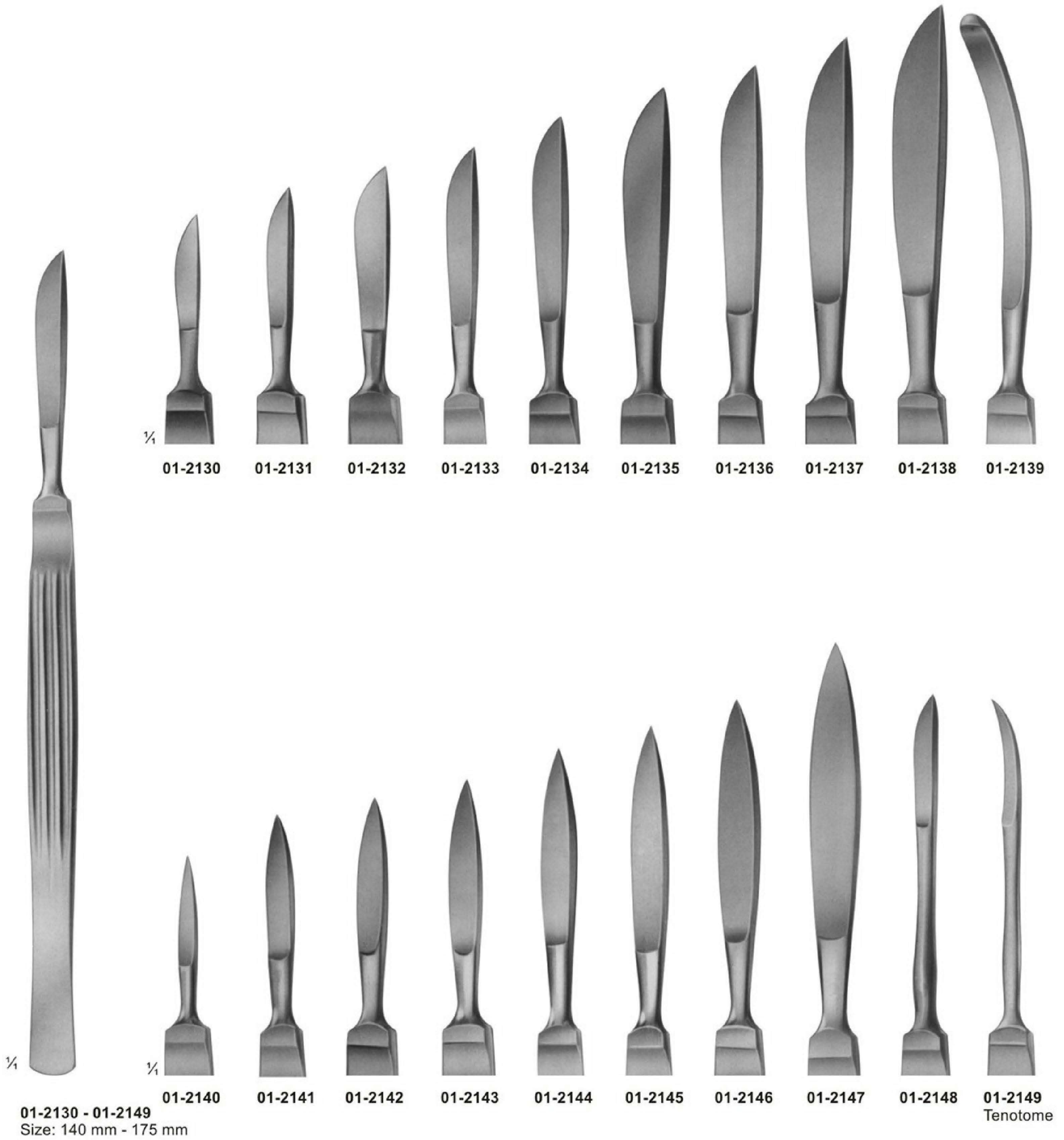

# Amputating Knives, Cartilage Knives, Autopsy Knives

Double Cutting

Double Cutting



<p>1/2</p> <p><b>LISTON</b>  <b>01-2150</b>          Size: 130 mm  <b>01-2151</b>          Size: 160 mm  <b>01-2152</b>          Size: 190 mm  <b>01-2153</b>          Size: 220 mm</p> <p>Blade Length          Amputating Knives</p>	<p>1/2</p> <p><b>01-2154</b>  <b>CATLIN</b>          Size: 160 mm          Blade Length          Amputating          Knives</p>	<p>1/2</p> <p><b>01-2155</b>  <b>LANGENBECK</b>          Size: 120 mm          Blade Length          Flap Knives</p>	<p>1/2</p> <p><b>01-2156</b>          Size: 110 mm          Blade Length          Interosseous          Knives</p>	<p>1/2</p> <p><b>01-2157</b>          Size: 55 mm          Blade Length          With Raspatory,          Wooden Handle</p>	<p>1/2</p> <p><b>01-2158</b>          Size: 70 mm          Blade Length          Wooden Handle</p>	<p>1/2</p> <p><b>01-2159</b>          Size: 80 mm          Blade Length          Metal Handle</p>	<p>1/2</p> <p><b>01-2160</b>          Size: 195 mm          Blade Length          Metal Handle</p>
--	---	--	--	---	--	---	--



# Cone Knives, Myomatome, Trigeminal & Tonsil Knives



**01-2161**  
 AYRE  
 Size: 235 mm  
 Cone Knife

**01-2162**  
 Size: 230 mm  
 Cone Knife

**01-2163**  
 SEGOND  
 Size: 270 mm  
 Myomatome

**01-2164**  
 OLIVECRONA  
 Size: 205 mm  
 Trigeminal  
 Knife

**01-2165**  
 Size: 230 mm  
 Trigeminal  
 Knife

**01-2166**  
 FOWLER  
 Size: 200 mm  
 Tonsil Knife

**01-2167**  
 ABRAHAM  
 Size: 215 mm  
 Tonsil Knife

**01-2168**  
 BRUENINGS  
 Size: 215 mm  
 Tonsil Knife

# Scalpels, Dura Knives & Comedone Extractors

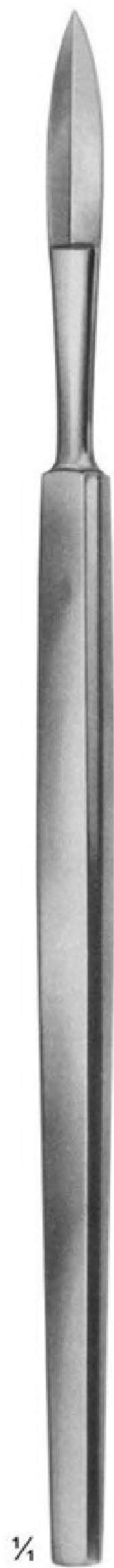

¼

**01-2169 - 01-2170**  
 JOSEPH  
 Size: 145 mm

Double Edged  
 Nasal Knives, Pointed



¼

**01-2169**  
 Straight

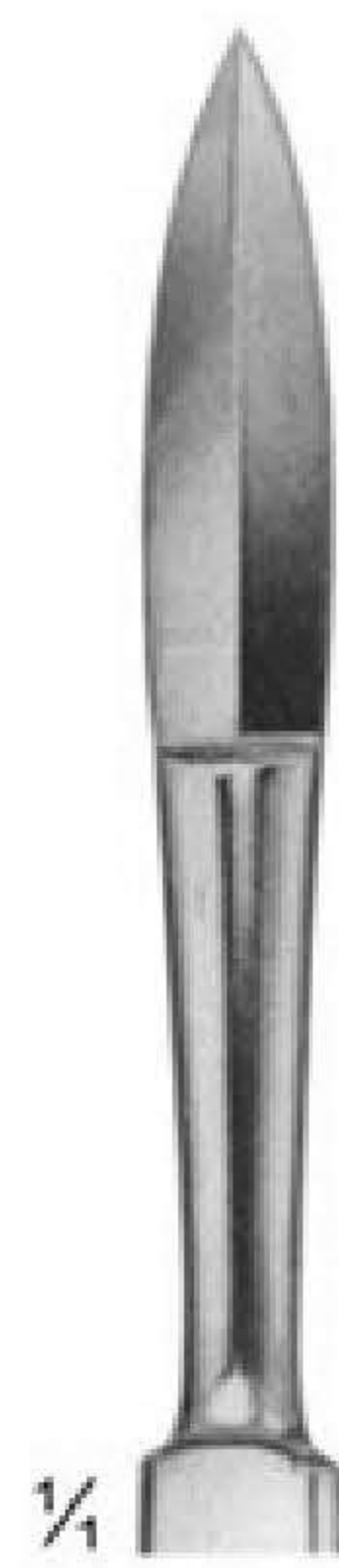

¼

**01-2170**  
 Curved



¼

**01-2171 - 01-2173**  
 ZIEGLER  
 Size: 120 mm  
 Milium Knives



¼

**01-2171**  
 Small

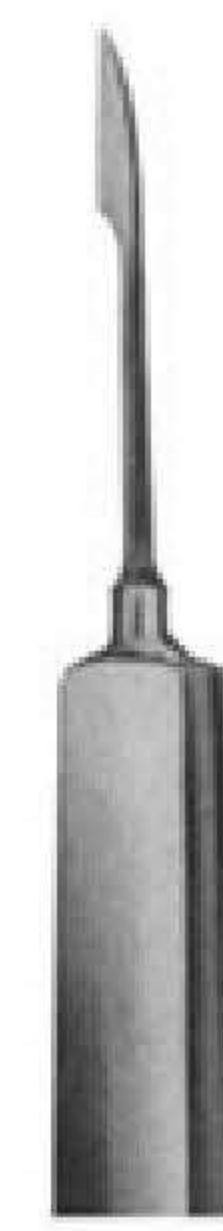

**01-2172**  
 Large



**01-2173**  
 Pointed



¼

**01-2174**  
 VIDAL  
 Lupus Scraper  
 Size: 135 mm

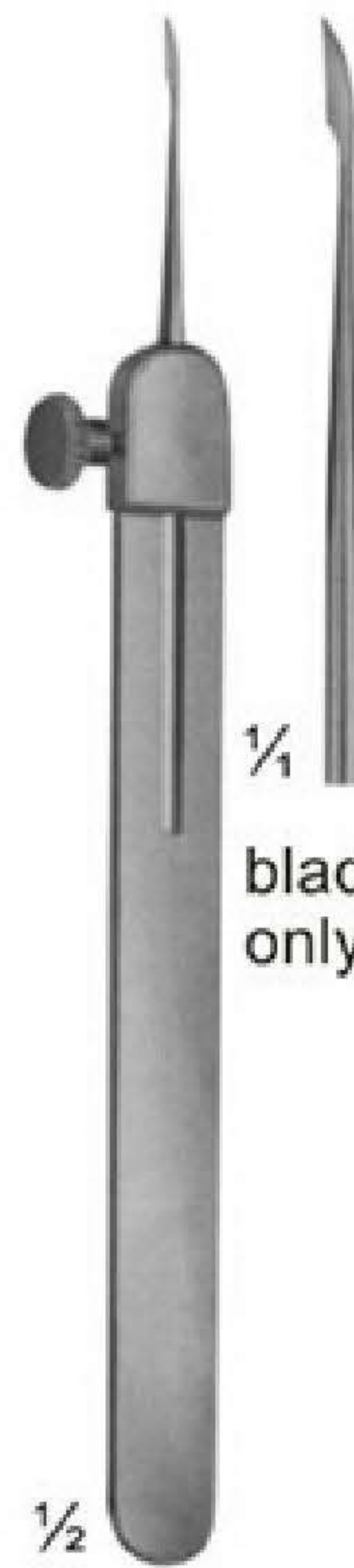

½

**01-2175**  
 MONCORPS  
 Milium Knives  
 Size: 130 mm

¼

blade  
 only

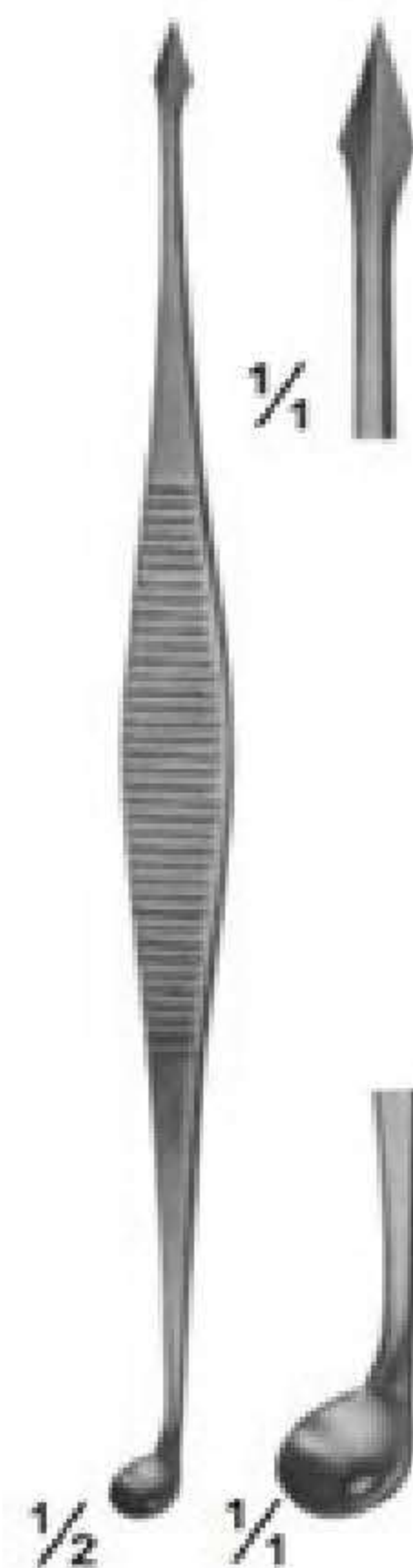

½

**01-2176**  
 SAALFELD  
 Size: 100 mm

¼



½

**01-2177**  
 HEBRA  
 Size: 180 mm

¼

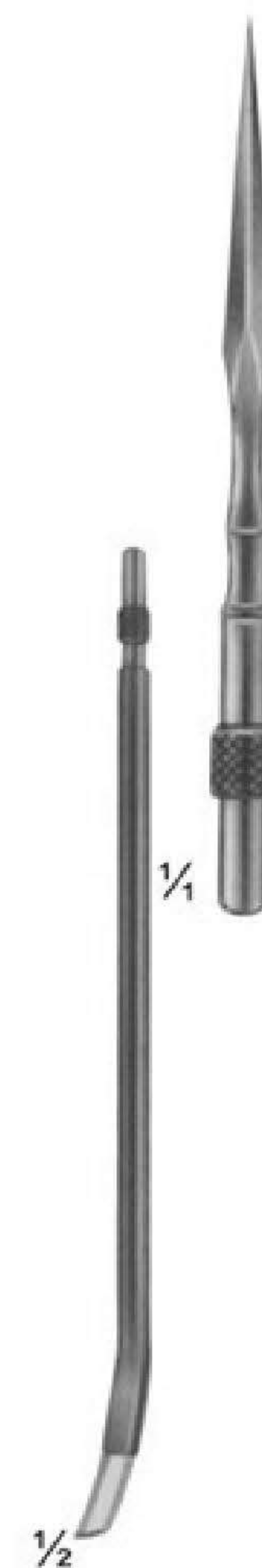

½

**01-2178**  
 Size: 145 mm

¼



¼

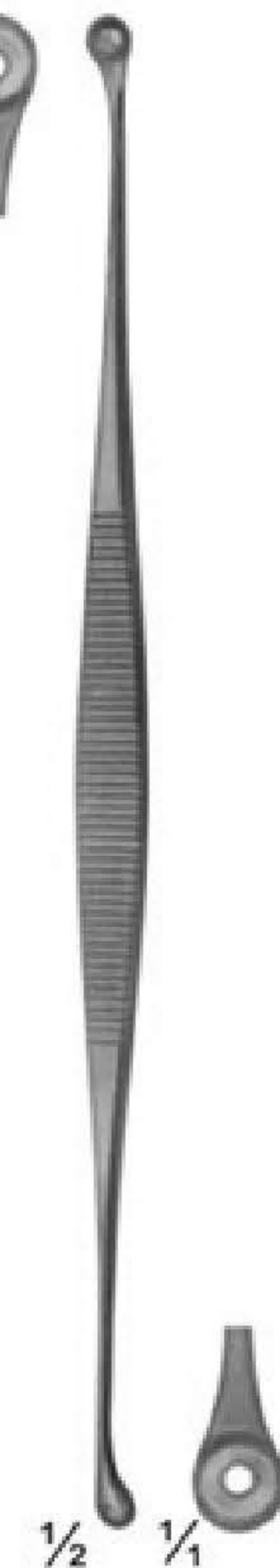

½

**01-2179**  
 UNNA  
 Size: 145 mm

¼

# Razor Blade Holders & Breakers

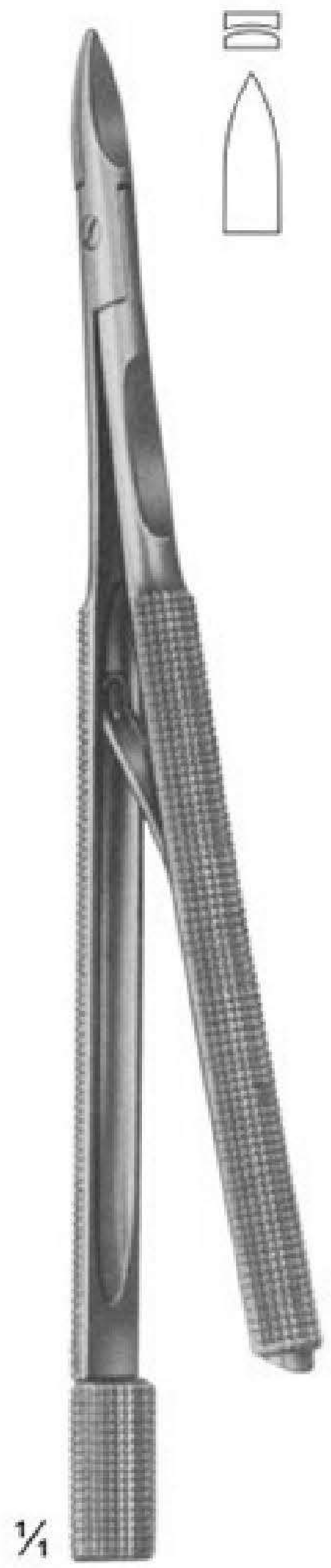

**01-2180**  
 TROUTMAN-CHRIS  
 Size: 90 mm  
 Handle Diameter 5.5 mm

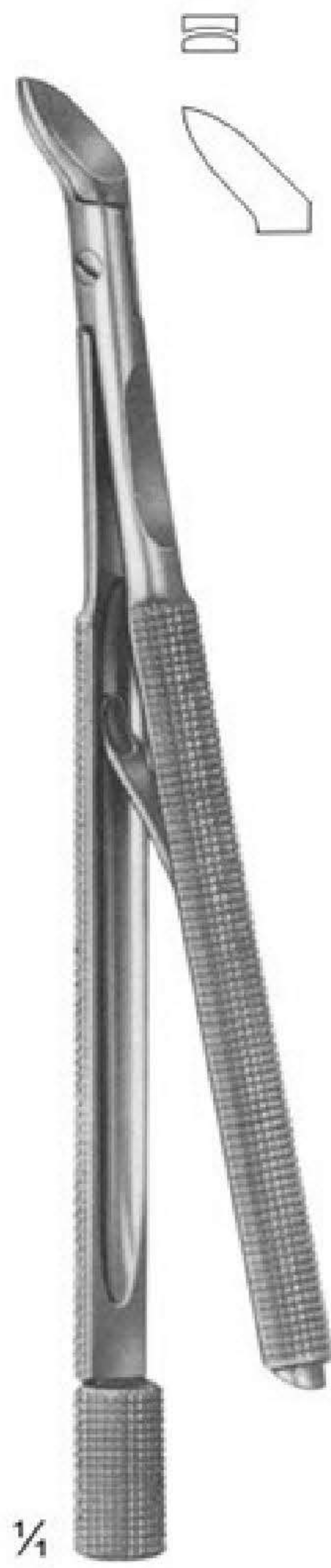

**01-2181**  
 TROUTMAN-CHRIS  
 Size: 90 mm  
 Handle Diameter 5.5 mm



**01-2182**  
 Size: 110 mm



**01-2183**  
 CASTROVIEJO  
 Size: 130 mm  
 Handle Diameter 8 mm



**01-2184**  
 Size: 185 mm  
 Razor Blade  
 Breaker & Holder,  
 Straight

# Scalpel Handles



**01-2185**  
 STANDARD  
 No. 4  
 Solid

**01-2186**  
 Double Handle  
 No. 4 + No. 3  
 Solid

**01-2187**  
 No. 4 L  
 Straight  
 Solid

**01-2188**  
 No. 4 L  
 Solid Angled

**01-2189**  
 COLLIN  
 No. 8  
 Hollow

**01-2190**  
 COLLIN  
 No. 9  
 Hollow

**01-2191**  
 Plastic  
 No.4

# Scalpel Handles

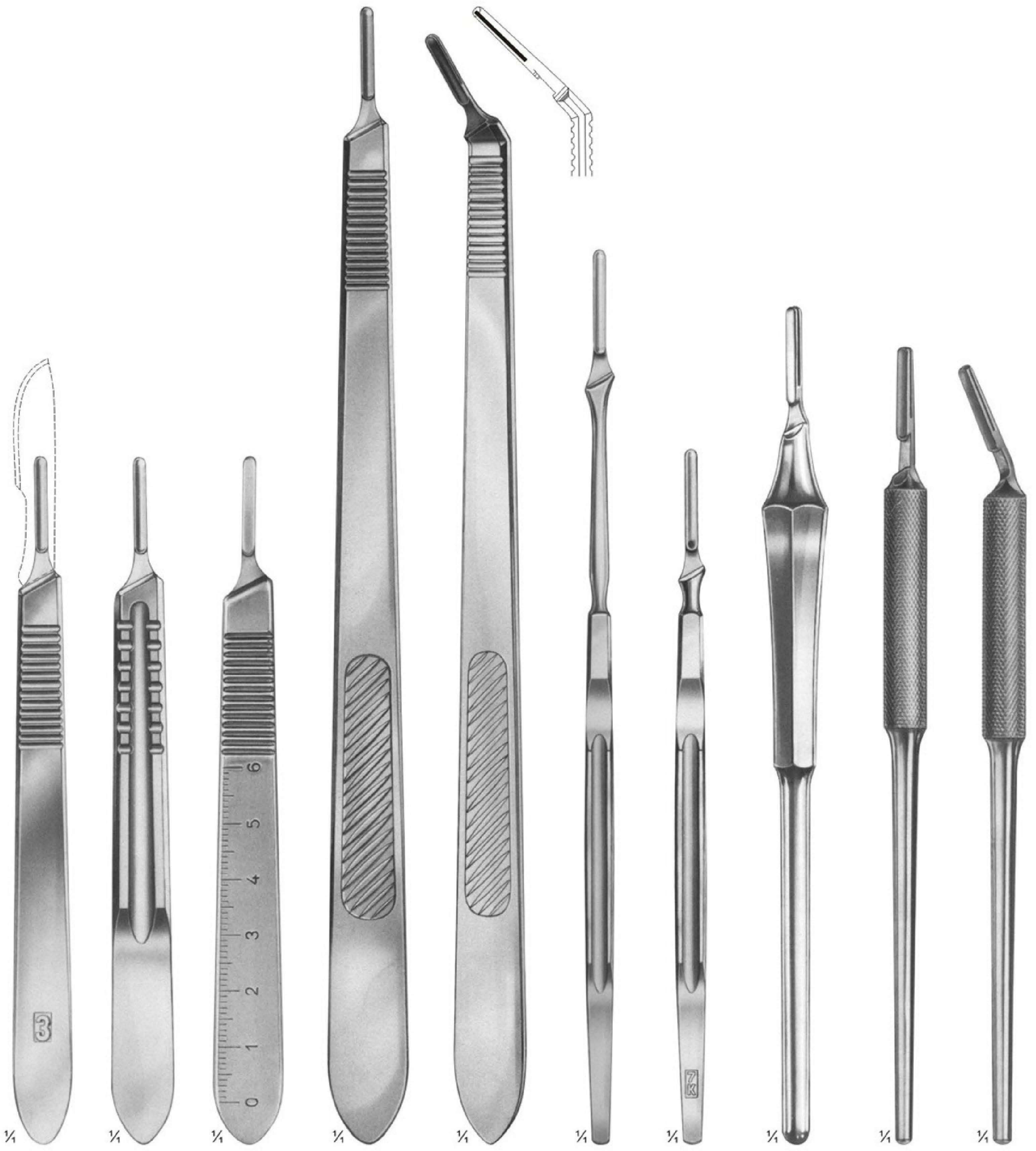

¼	¼	¼	¼	¼	¼	¼	¼	¼	¼
<b>01-2192</b> STANDARD No. 3 Solid Size:12cm	<b>01-2193</b> No. 3 Solid Size:12cm solid handle style as No.4	<b>01-2194</b> No. 3 Solid Size:12cm cm-graduation	<b>01-2195</b> No. 3 L Straight Solid, long Size:21.5cm	<b>01-2196</b> No. 3 L Angled Solid, long Size:21cm	<b>01-2197</b> No. 7 Solid Size:16cm	<b>01-2198</b> No. 7 K Solid, short Size:12.5cm	<b>01-2199</b> No.3 Size:15.5cm with round hollow handle	<b>01-2200</b> No. 3 Straight Solid, Round Size:14.5cm	<b>01-2201</b> No. 3 Angled Solid, Round Size:14cm

# Razors & Dermatomes



**01-2202**  
 SCHINK  
 Size: 310 mm  
 Complete with 2  
 skin fixing plates  
 and 1 blade.  
 Adjustable from  
 0.1 to 2.0mm



**01-2203**  
 SCHINK  
 Spare Blade

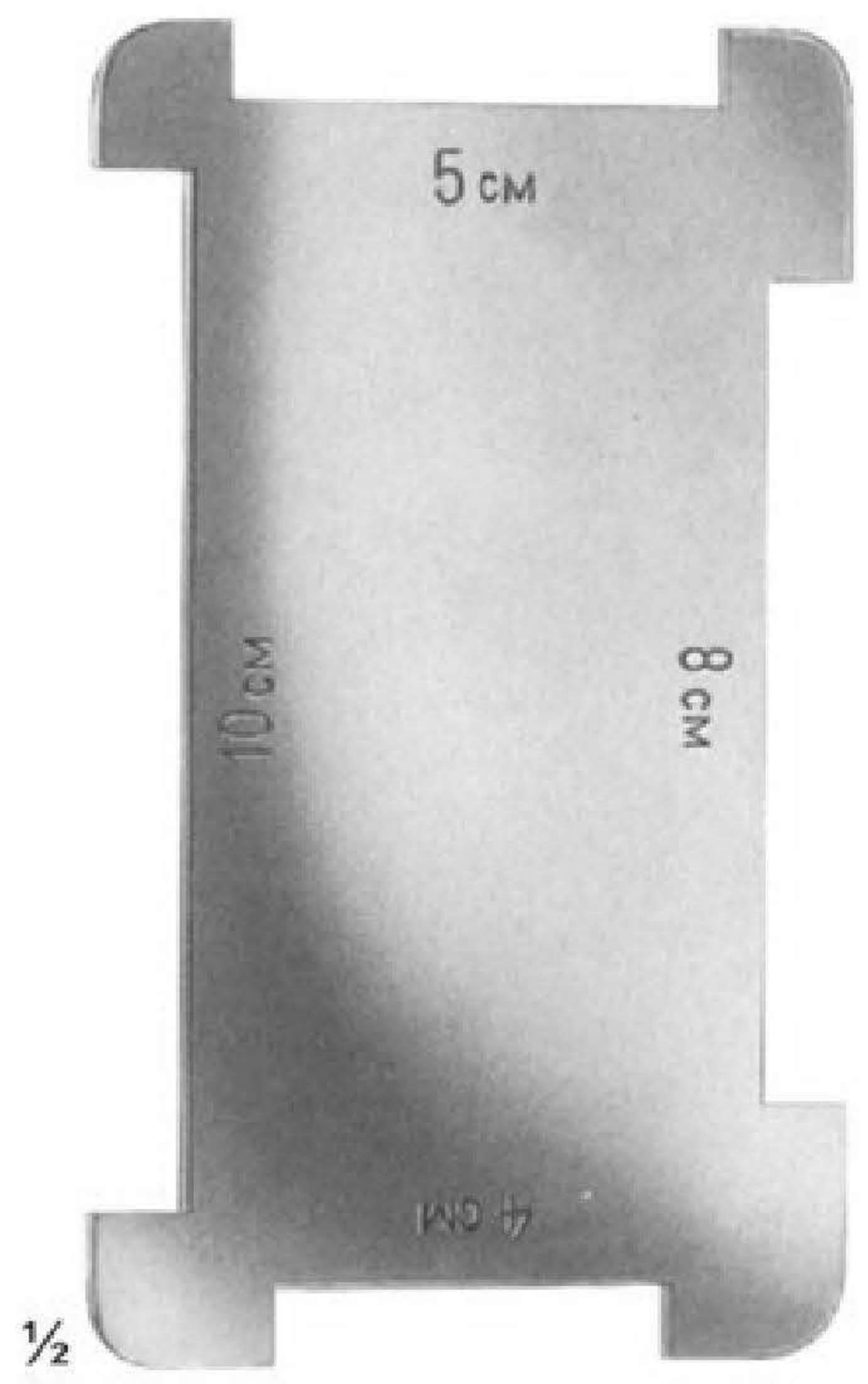

**01-2204**  
 SCHINK  
 Skin Fixing Plate



**01-2205**  
 SILVER  
 Size: 190 mm  
 For Usual  
 Razor Blades



**01-2206**  
 Size: 75 mm  
 Cutting Length



**01-2207**  
 Size: 80 mm  
 Cutting Length