

Micro Forceps, Jeweler Types and Micro Suture Tying Forceps

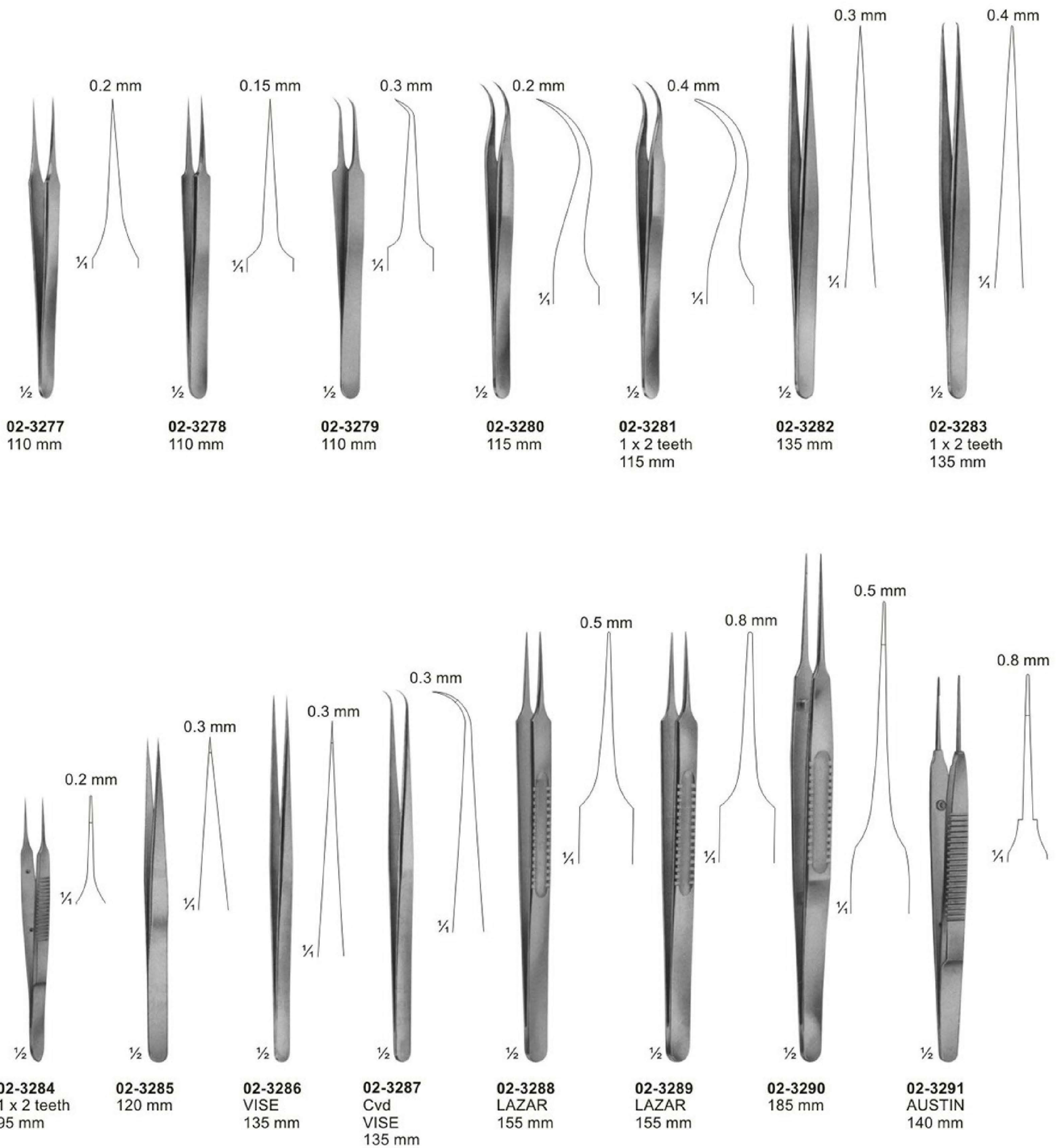

Micro Forceps, Ligature Forceps (Light Patterns) Bayonet - Shaped

0.15 mm 0.20 mm 0.30 mm 0.50 mm

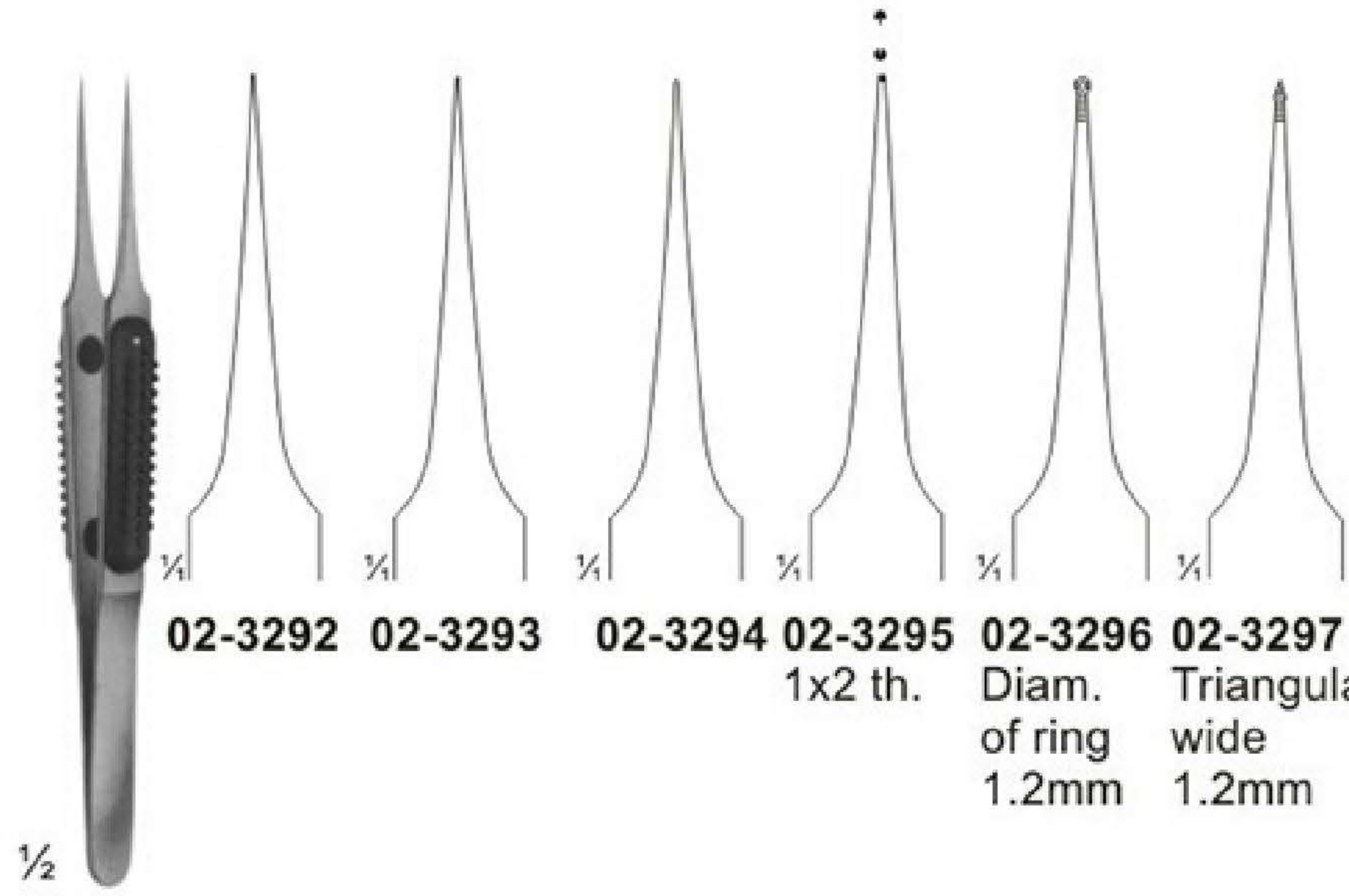

02-3292 02-3293 02-3294 02-3295 02-3296 02-3297
1x2 th. Diam. Triangular
of ring wide
1.2mm 1.2mm

02-3292 - 02-3297
MULLER
110 mm

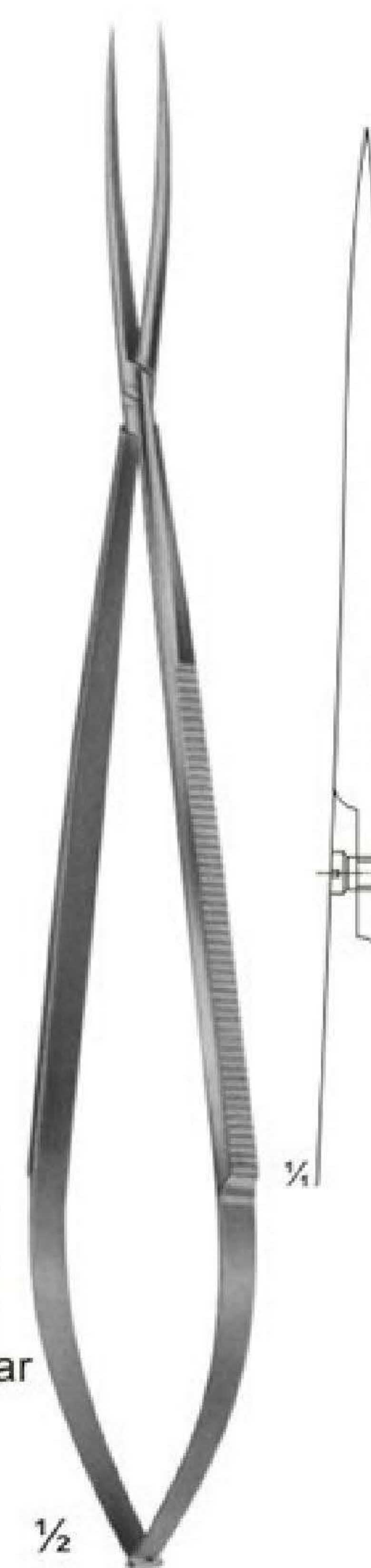

02-3298
LIGATURE
FORCEPS
220 mm



02-3299
YASARGIL
Ligature forceps
185 mm

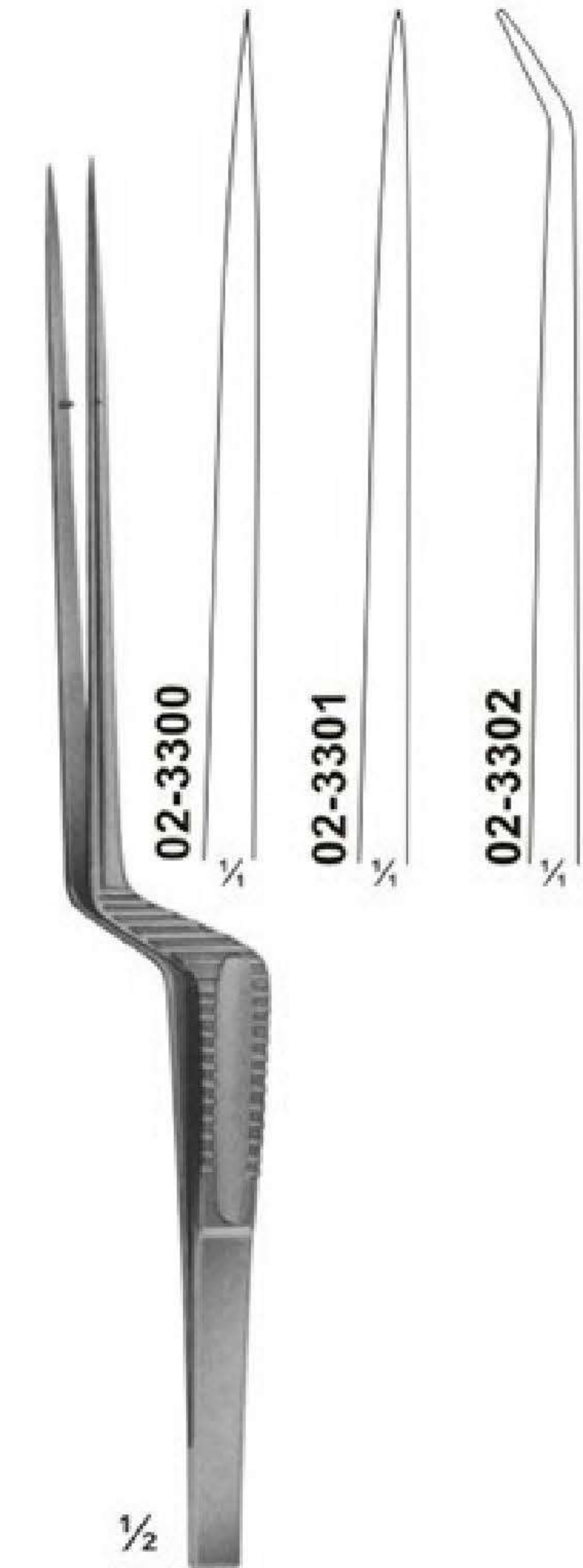

02-3300 - 02-3302
MICRO FORCEPS
Ligature pattern
185 mm

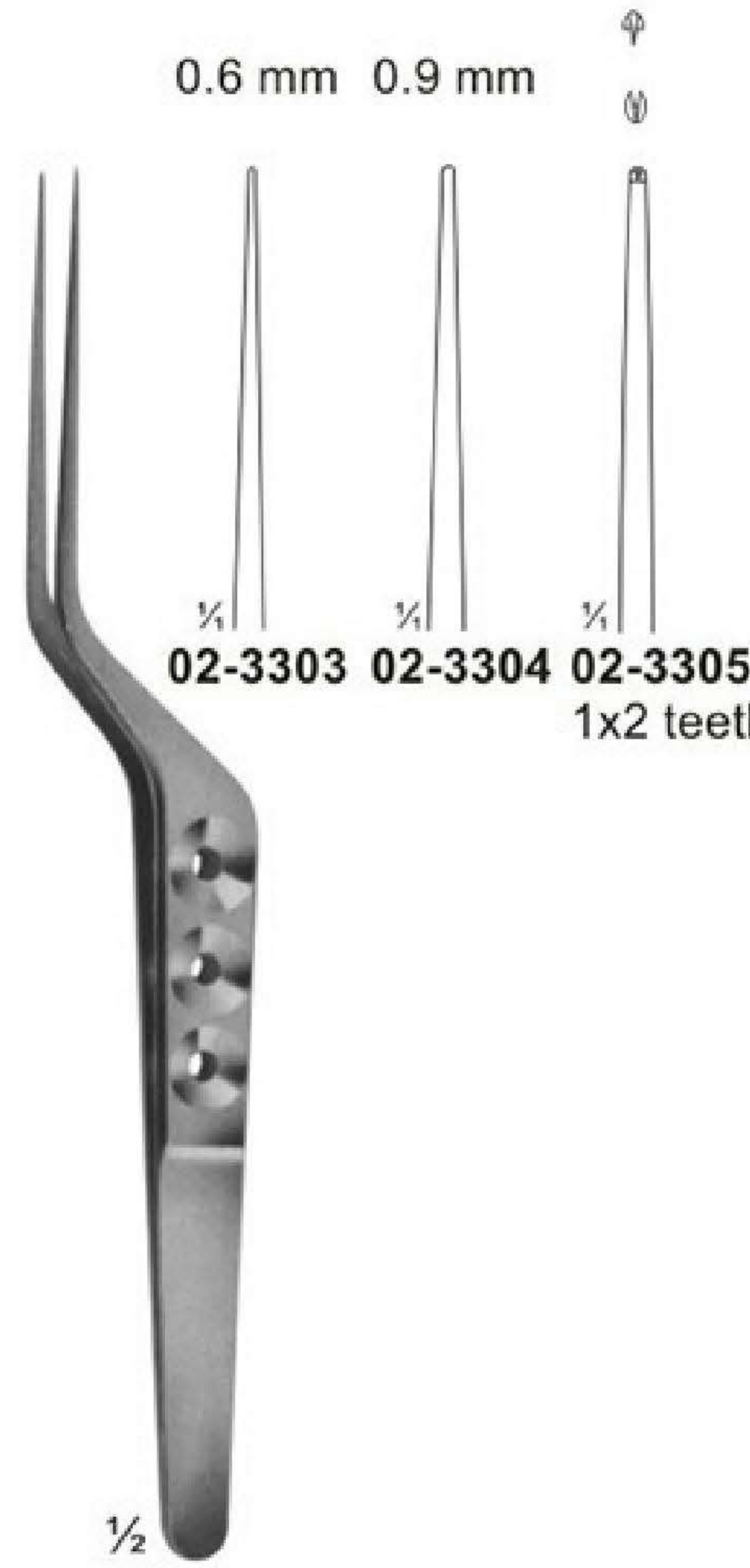

0.6 mm 0.9 mm
02-3303 02-3304 02-3305
1x2 teeth

02-3303 - 03-3305
YASARGIL
180 mm

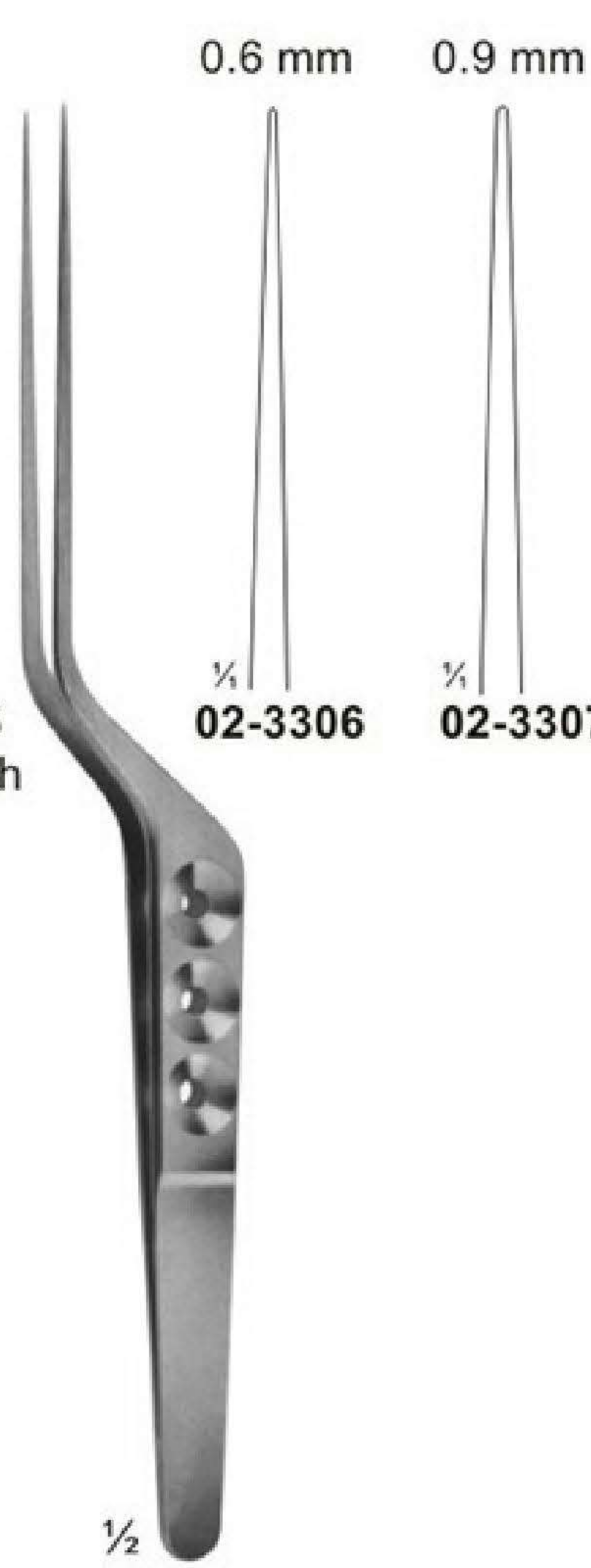

0.6 mm 0.9 mm
02-3306 02-3307

02-3306 - 02-3307
YASARGIL
200 mm



0.6 mm 0.9 mm
02-3308

02-3308 - 03-3309
YASARGIL
220 mm



0.6 mm 0.9 mm
02-3309



0.6 mm 0.9 mm
02-3310 02-3311

02-3310 - 02-3311
YASARGIL
240 mm

Forceps for Grasping Tissue, Tumors, Bayonet Shaped



02-3312 - 02-3314
YASARGIL-SAMII
Jaws Spoon-Shaped
240 mm



02-3315 - 02-3316
YASARGIL
Jaws Spoon-Shaped
220 mm



02-3317 - 02-3319
SAMII
Jaws Spoon-Shaped
230 mm



02-3320 - 02-3322
SAMII
Jaws Spoon-Shaped
230 mm

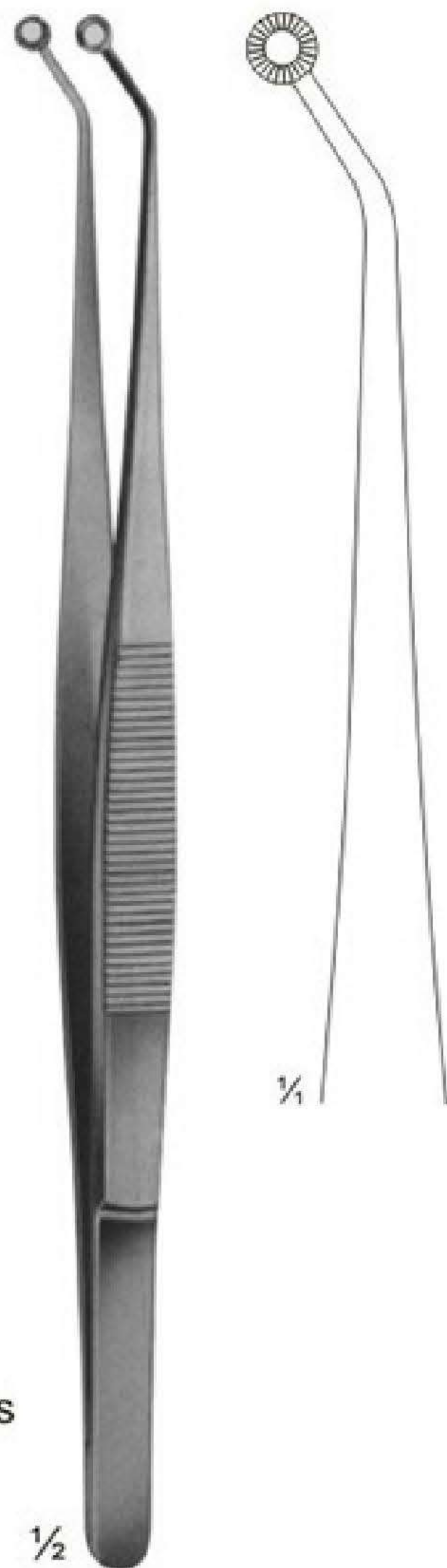

02-3323
HUNT
Tumor-and
Vessel Forceps
200 mm

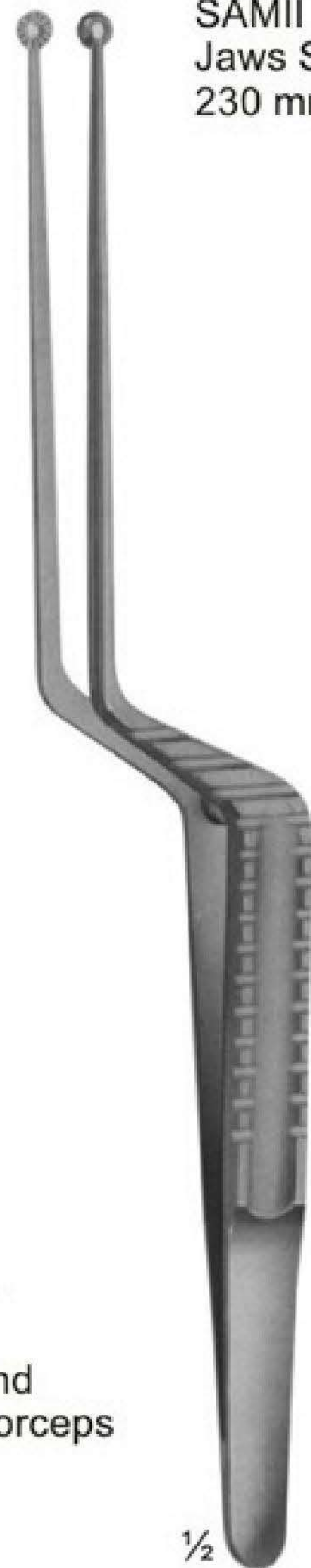

02-3324
HUNT
Tumor-and
Vessel Forceps
200 mm



02-3325
YASARGIL
Tumor-and
Vessel Forceps
200 mm



Delicate Dissecting, Microscopic, Sterilizing Forceps

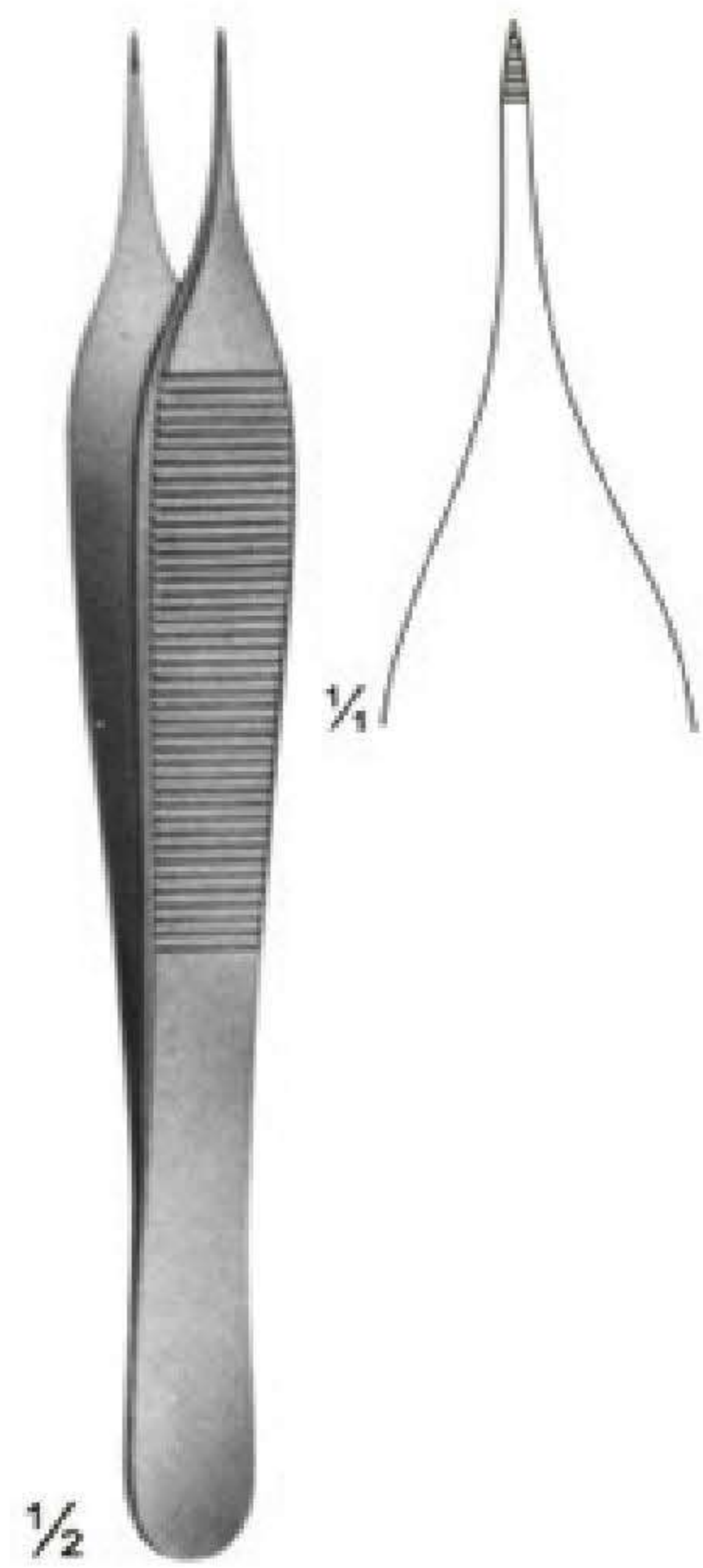

02-3326
THORPE
Corneal forceps
120 mm

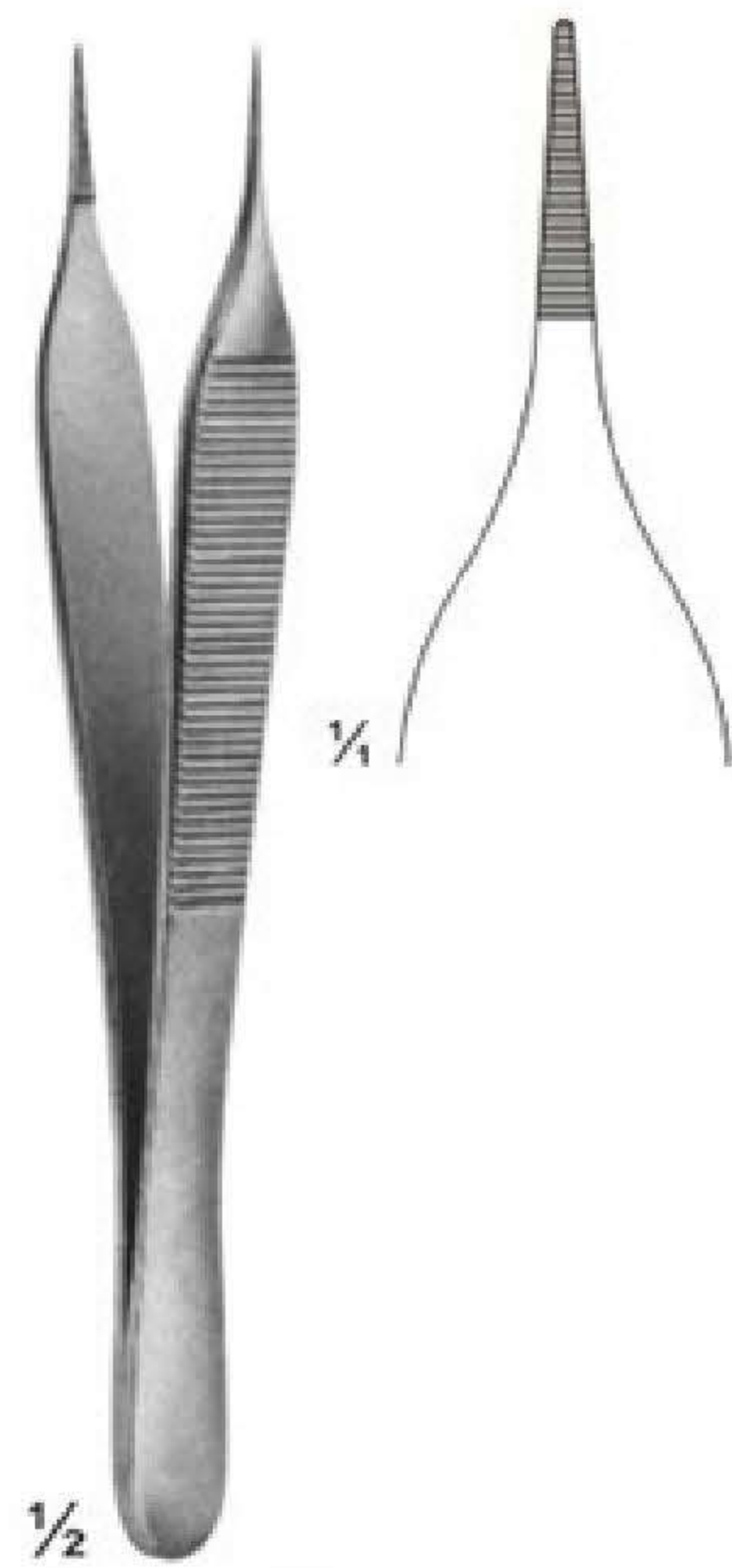

02-3327
MICRO-ADSON
120 mm

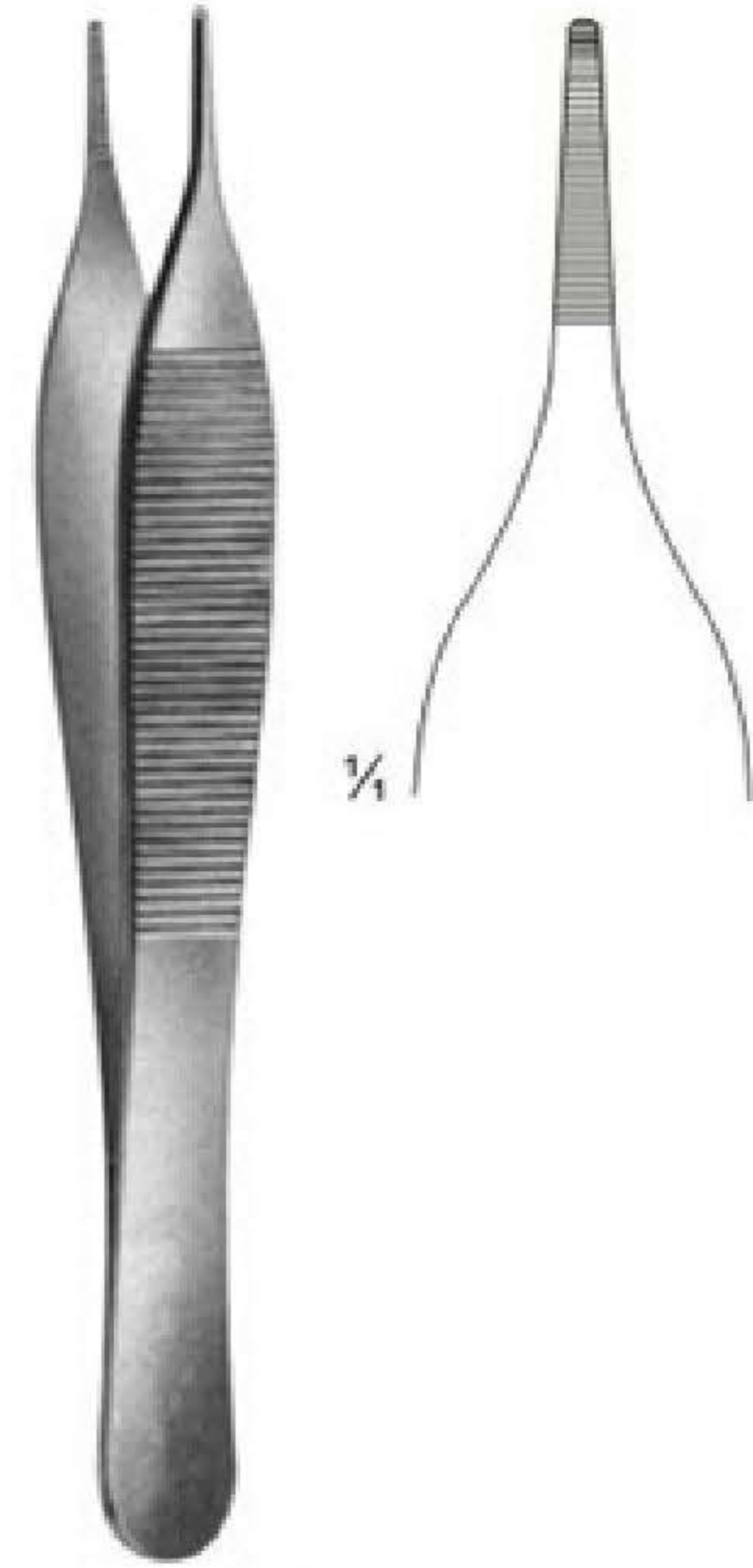

02-3328
ADSON
120 mm



02-3329
MICRO-ADSON
150 mm

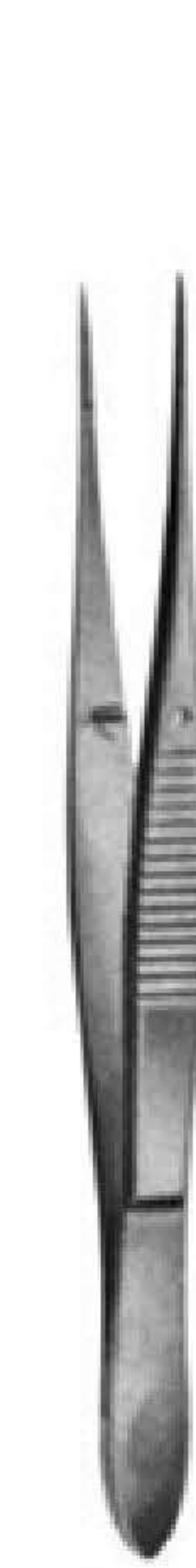

02-3330 - 02-3332
100 mm



02-3330



02-3331



02-3332

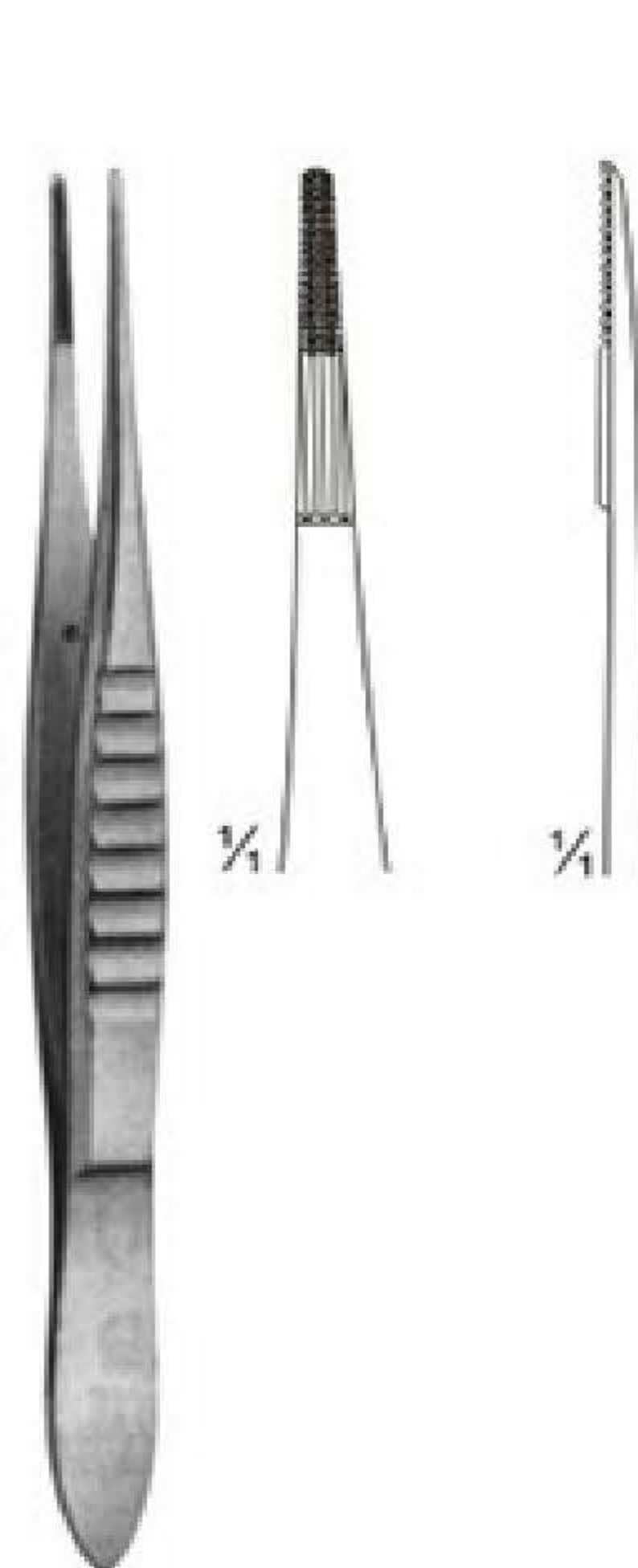

02-3333
BONACCOLTO
110 mm

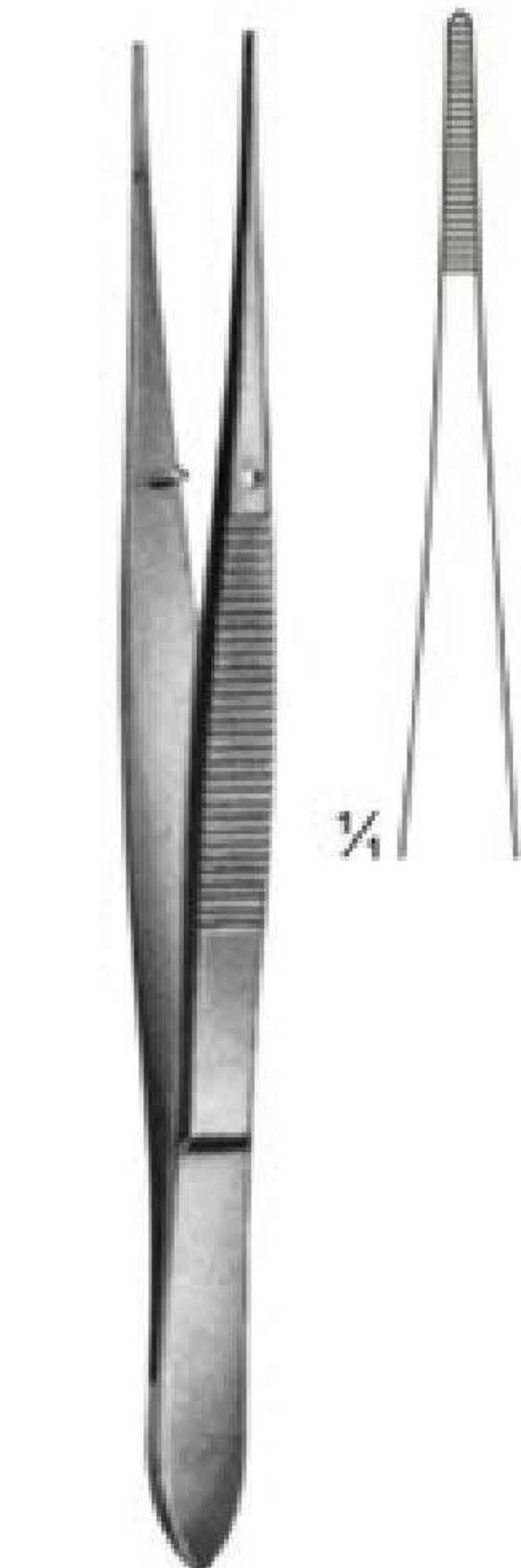

02-3334
115 mm

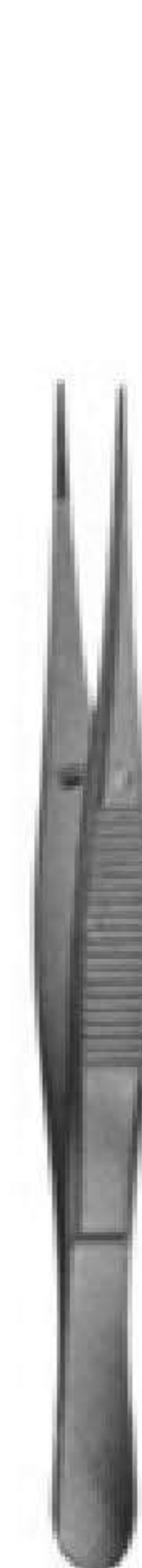

02-3335 - 02-3344



02-3335
90 mm



02-3336
105 mm



02-3337
115 mm



02-3338
130 mm



02-3339
145 mm



02-3340
90 mm



02-3341
105 mm



02-3342
115 mm



02-3343
130 mm



02-3344
145 mm



02-3345
100 mm



02-3346
100 mm

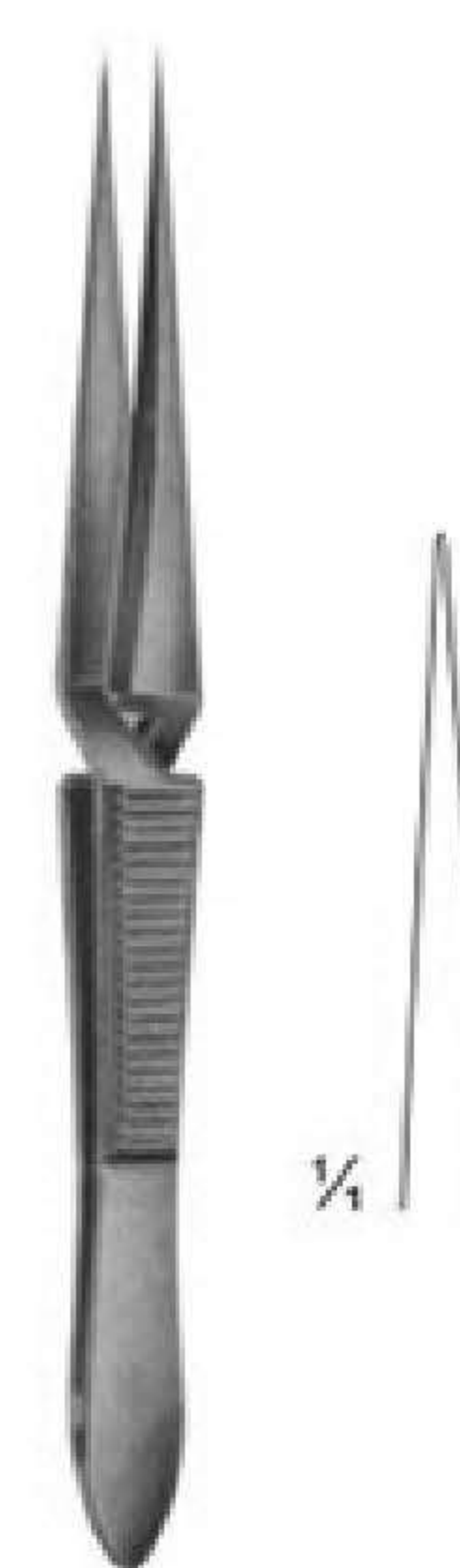

02-3347
100 mm



02-3348
KUHNE
Cover glass forceps
105 mm

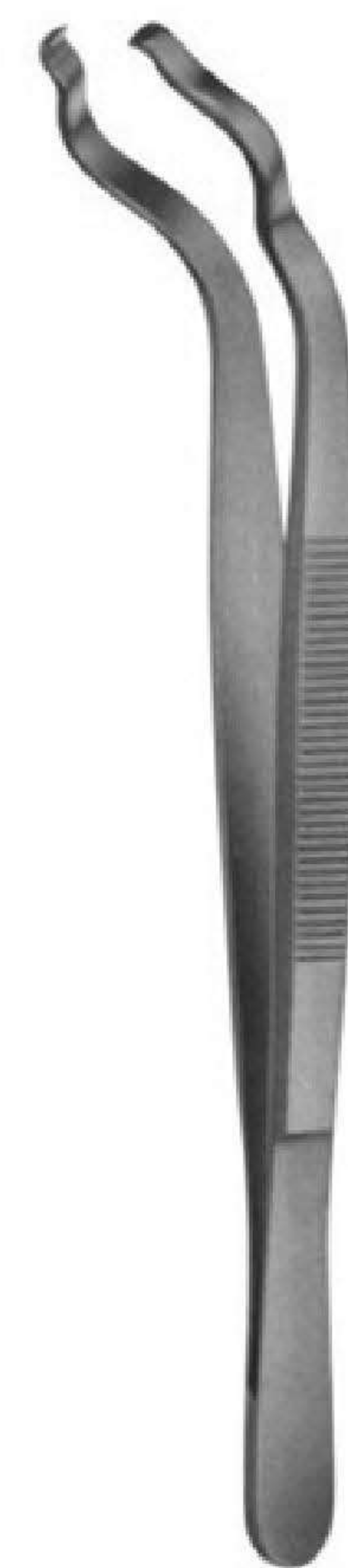

02-3349
160 mm

Delicate Dissecting Forceps

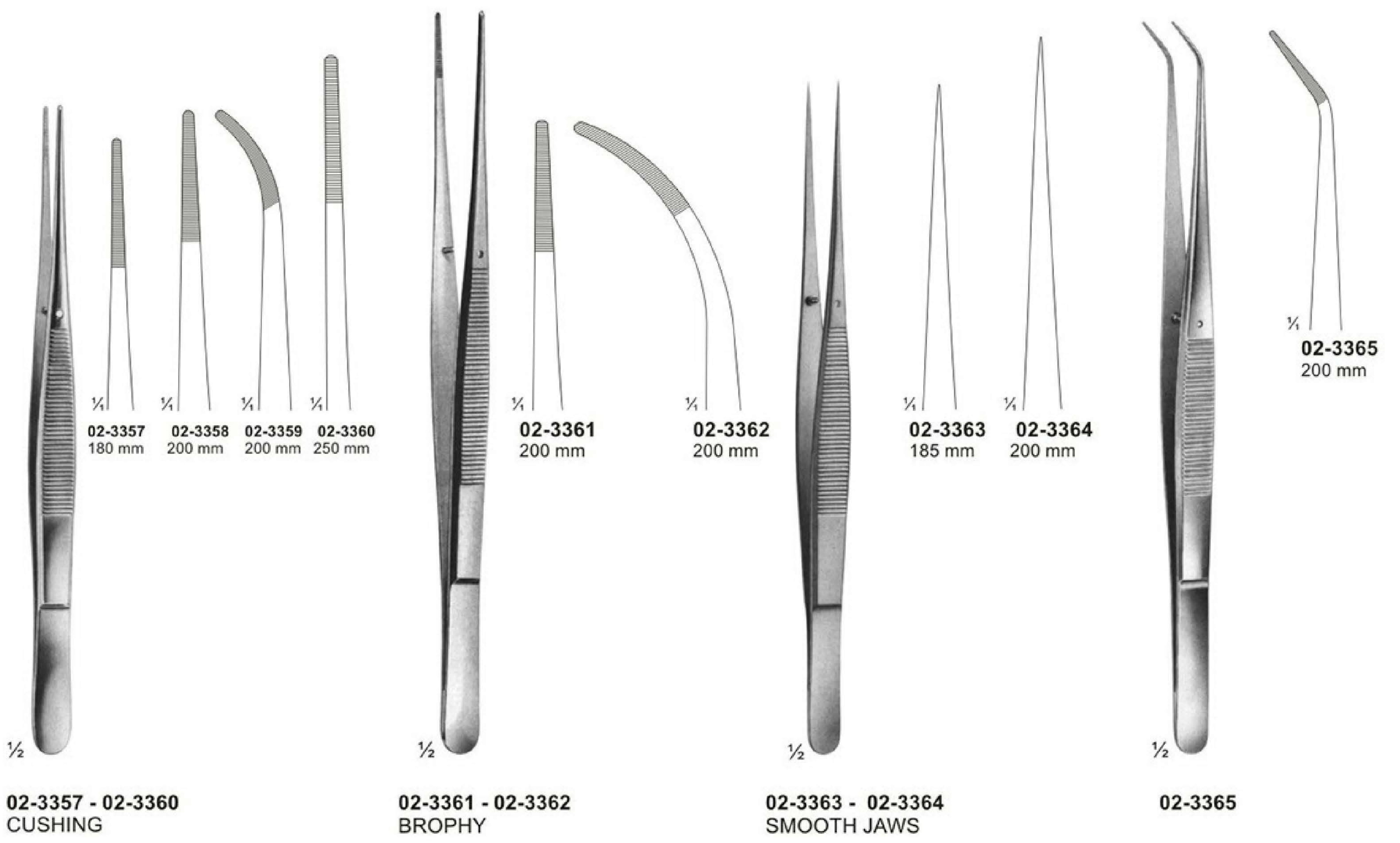
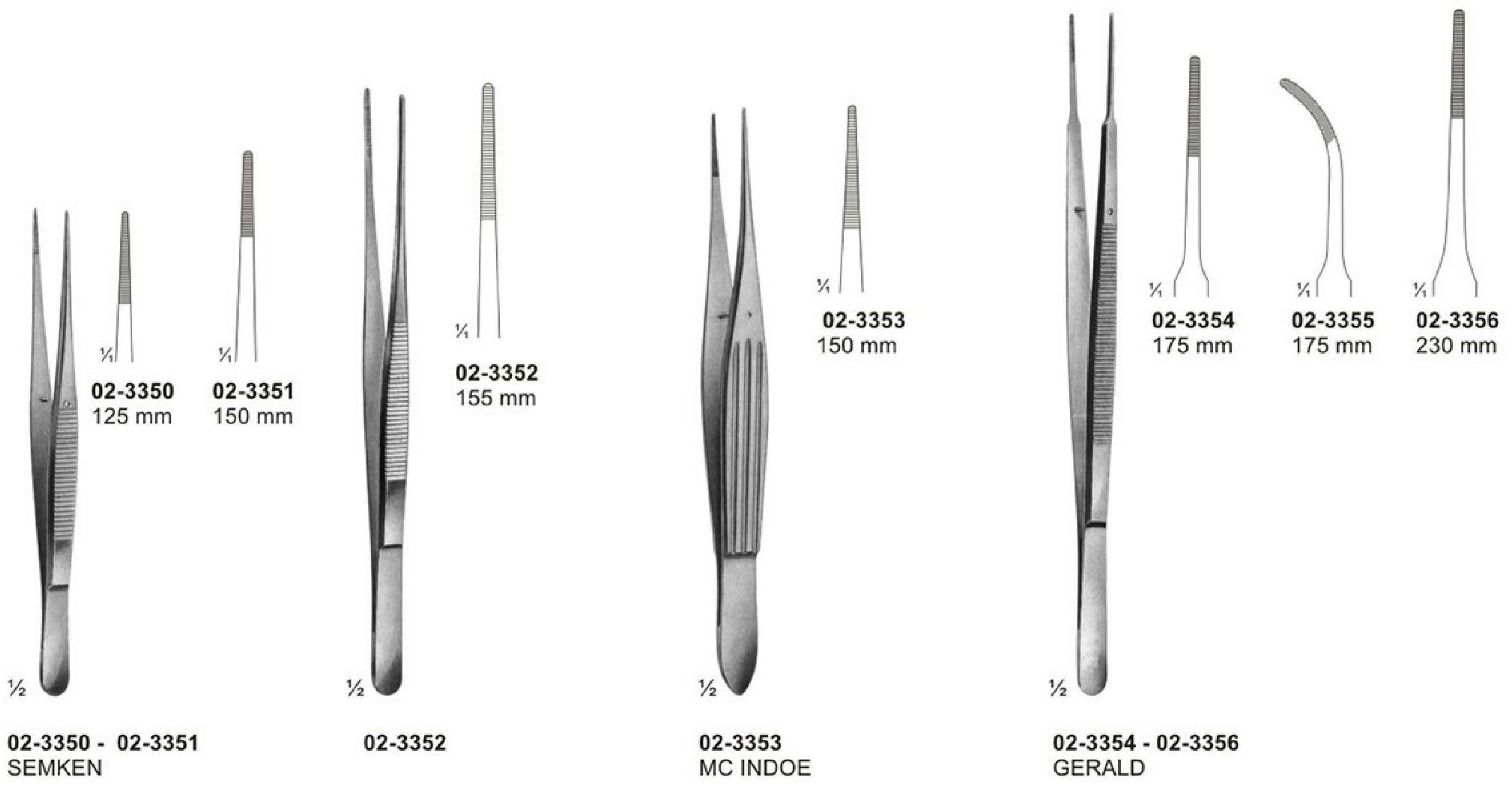

Dissecting Forceps

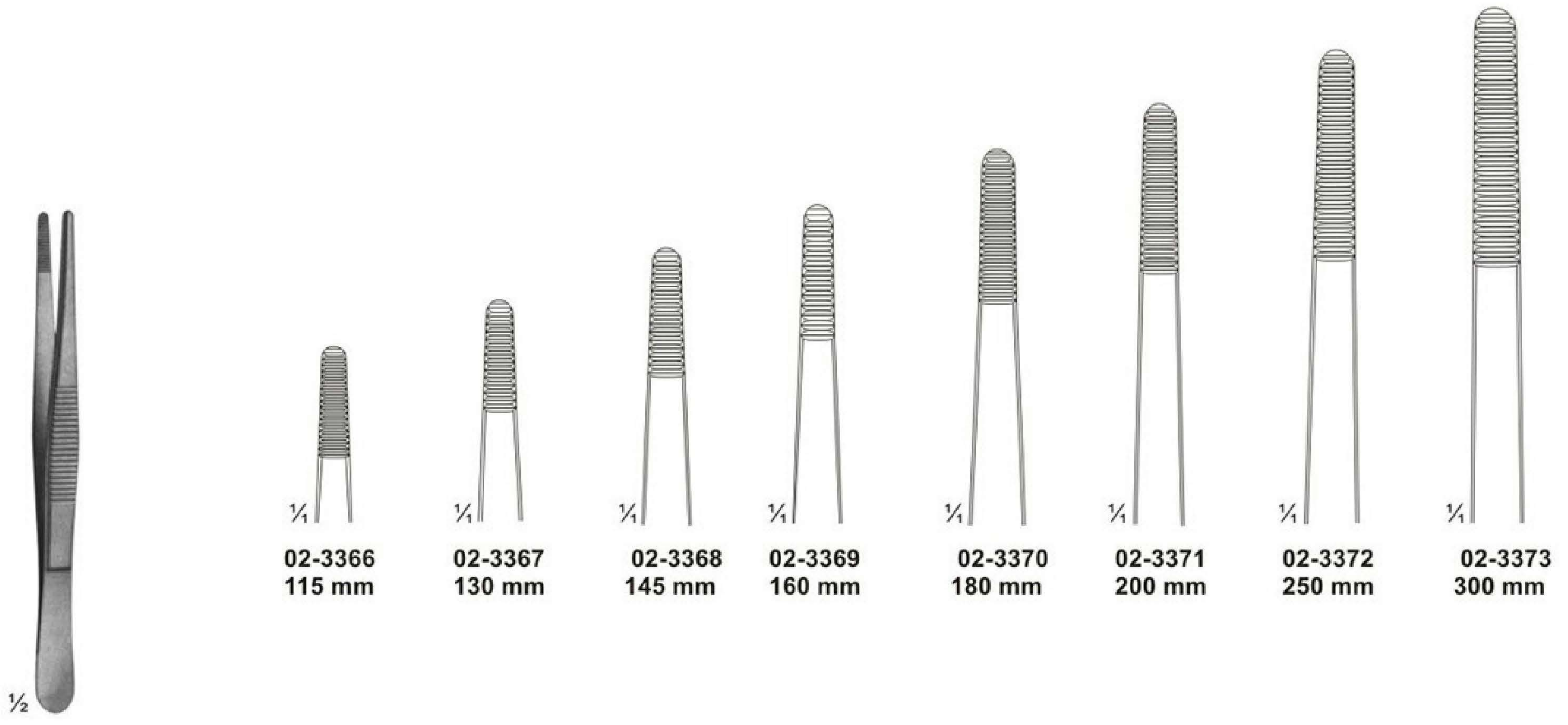

02-3366 - 03-3373
 STANDARD

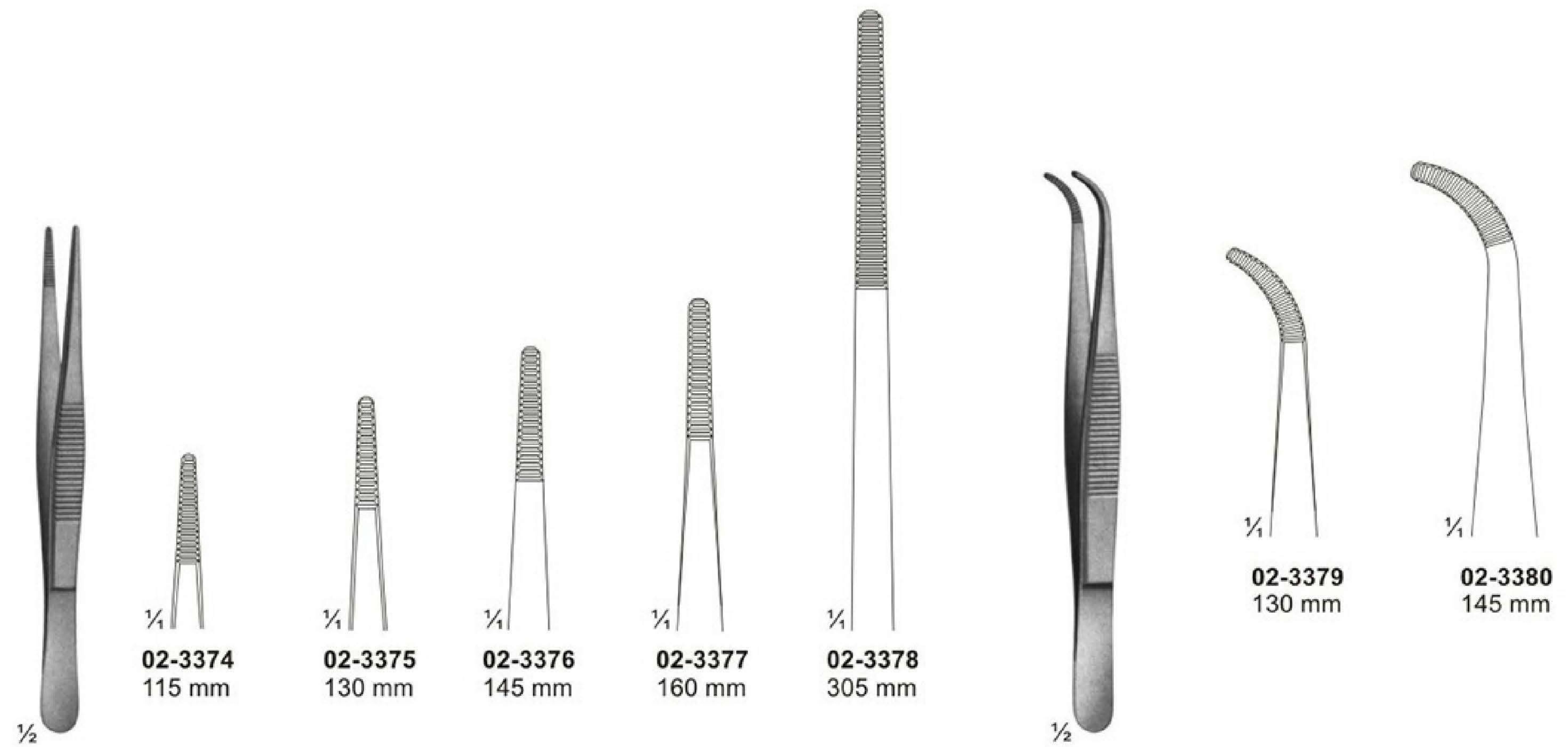

02-3374 - 02-3378
 MEDIUM

02-3379 - 02-3380
 MEDIUM

Dissecting Forceps

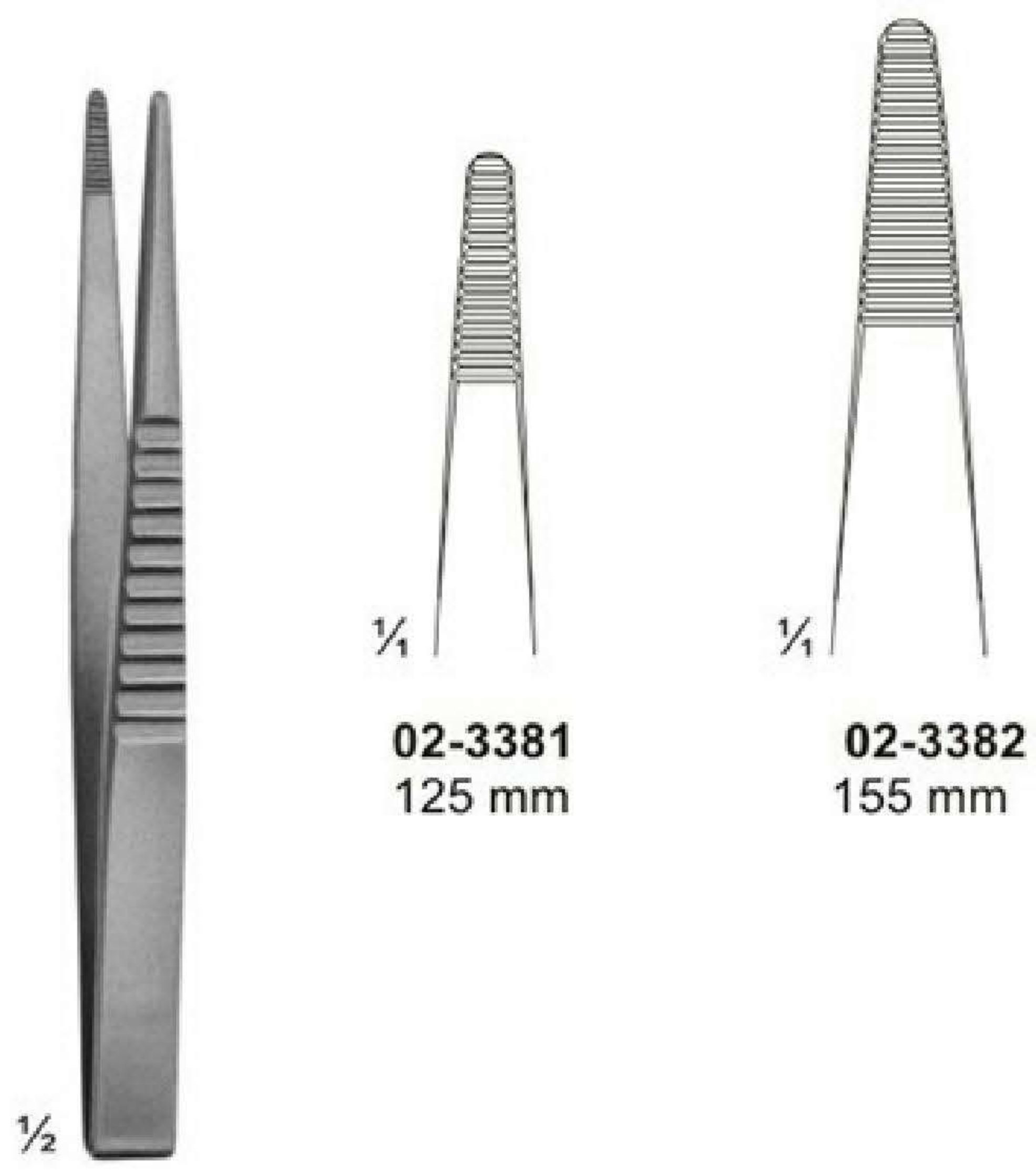

02-3381
125 mm

02-3382
155 mm

02-3381 - 02-3382

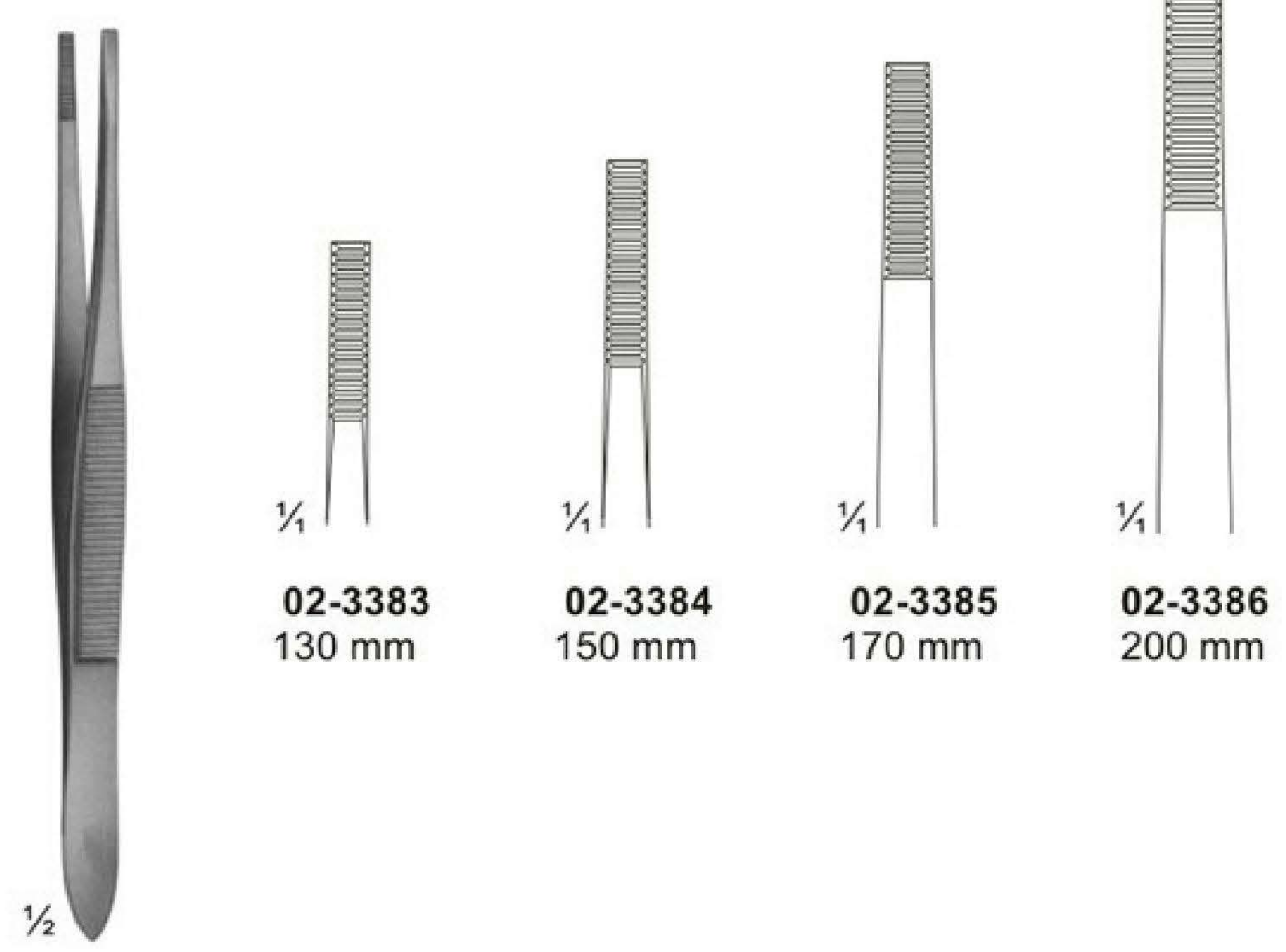

02-3383
130 mm

02-3384
150 mm

02-3385
170 mm

02-3386
200 mm

02-3383 - 02-3386
Swedish pattern

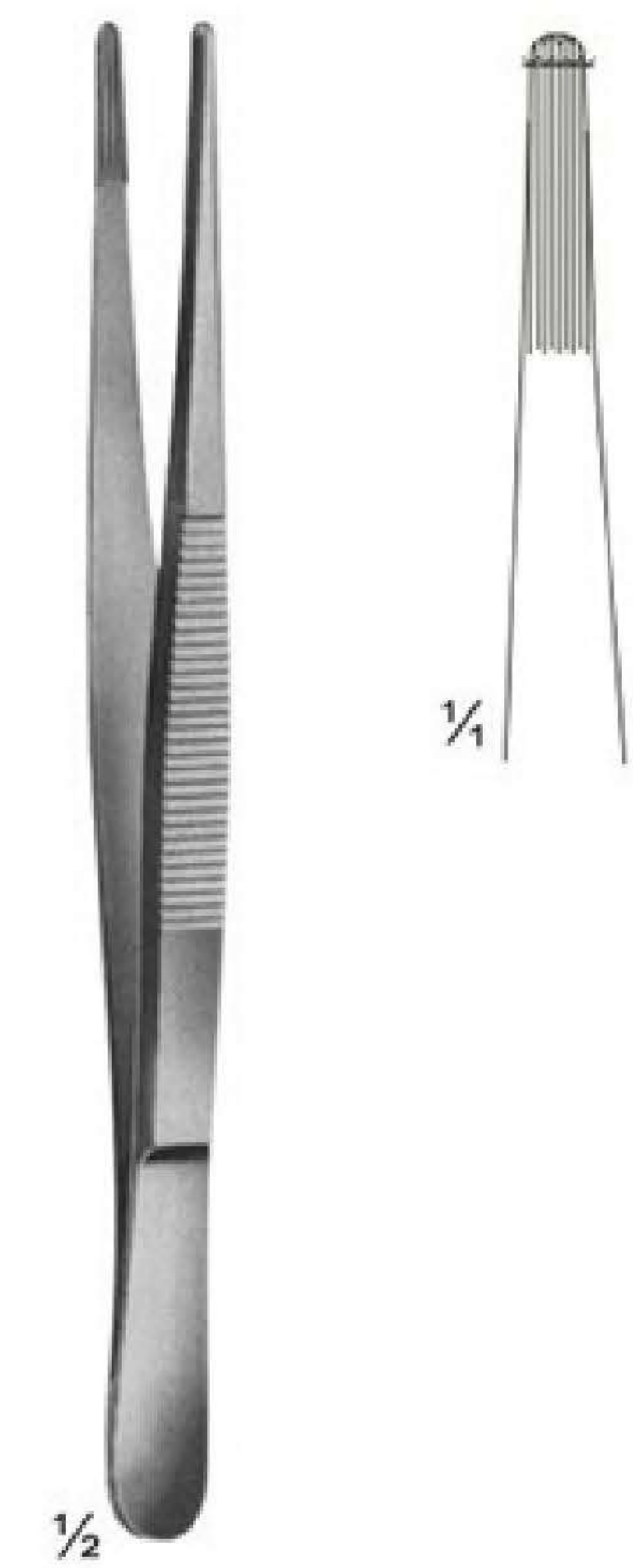

02-3387
OCHSNER
Ligature forceps
145mm

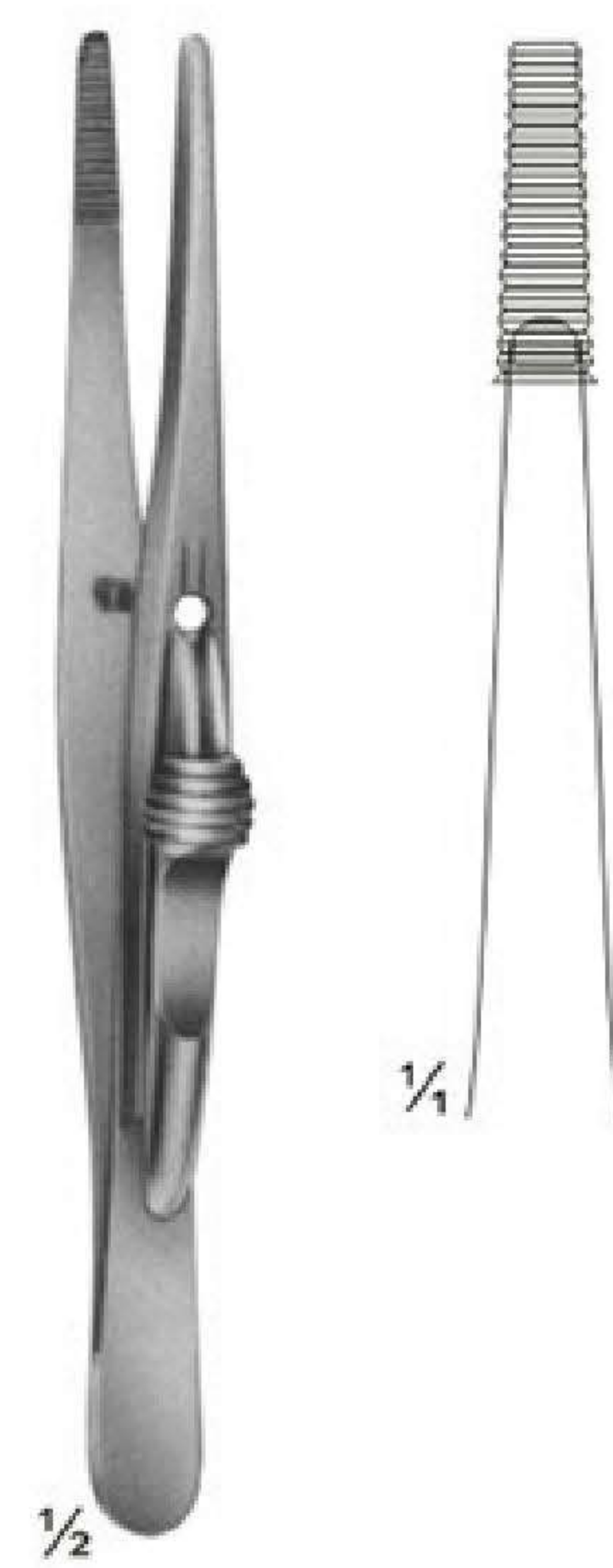

02-3388
FRICKE
Artery forceps
130mm

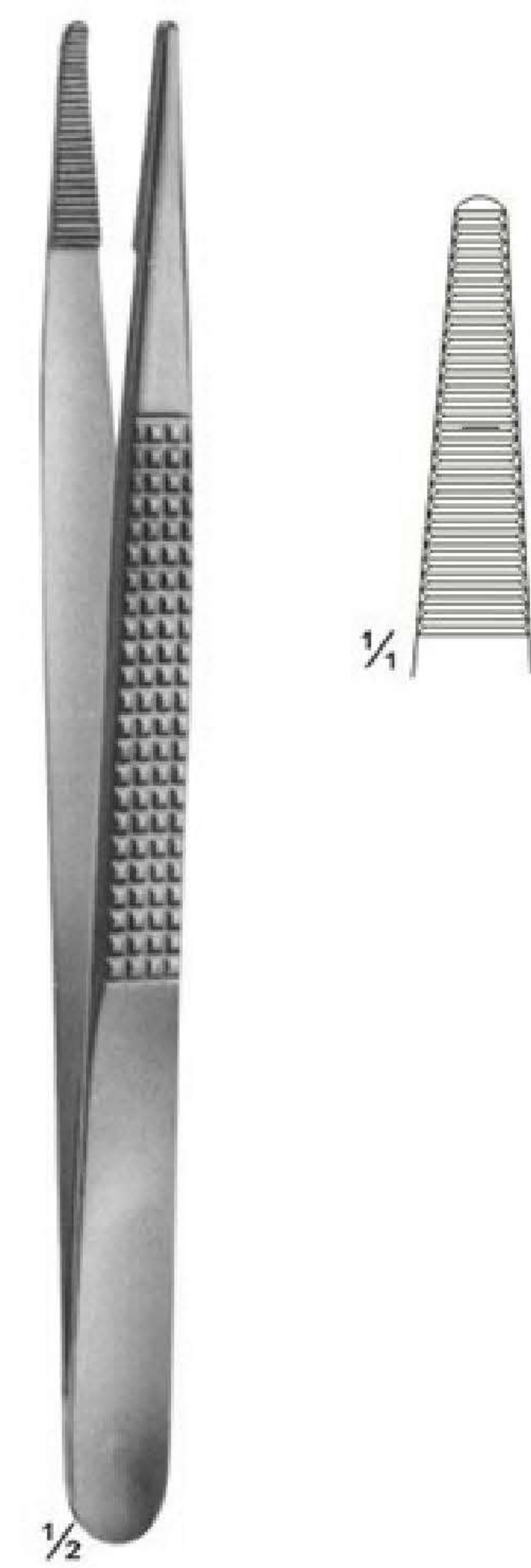

03-3389
BONNEY
175mm

Ultra-Light Forceps ATRAUMATA

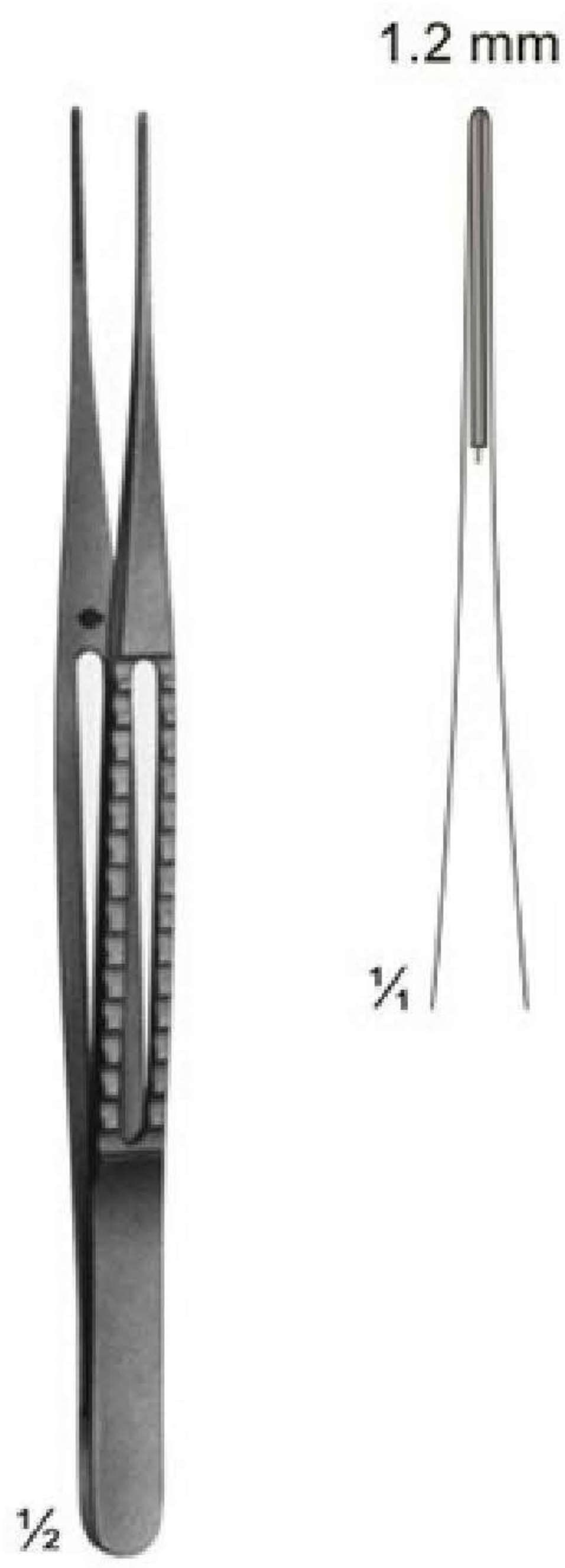

02-3390
150 mm

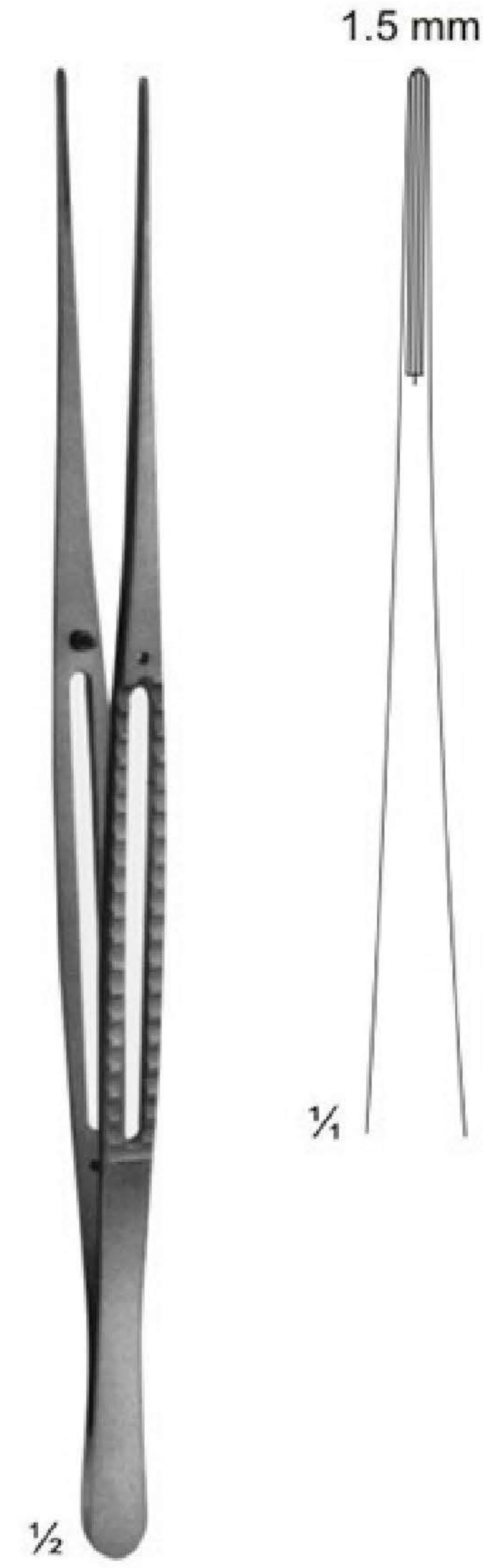

02-3391
200 mm

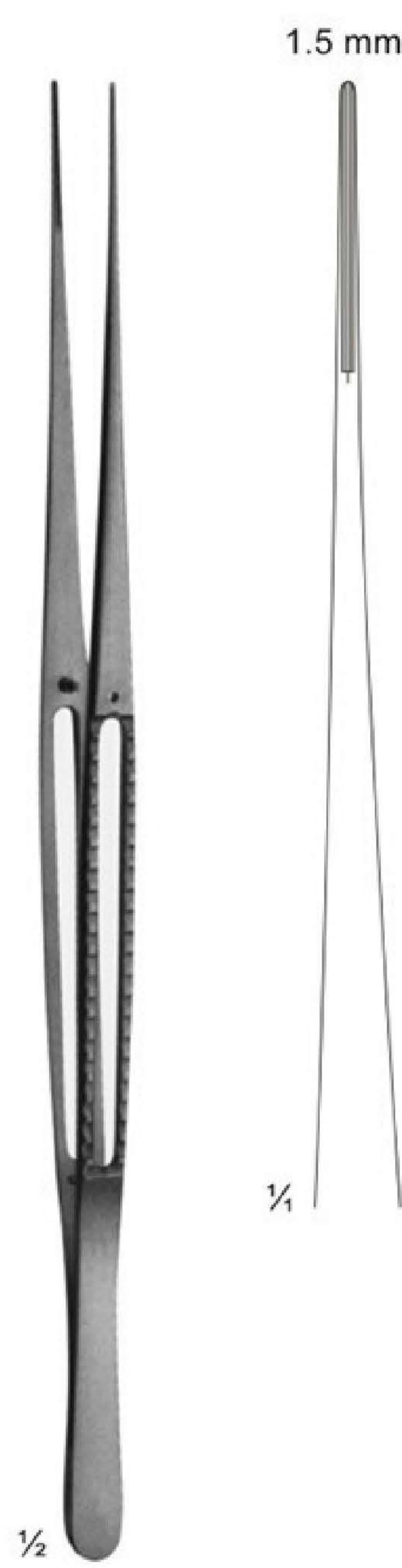

02-3392
240 mm

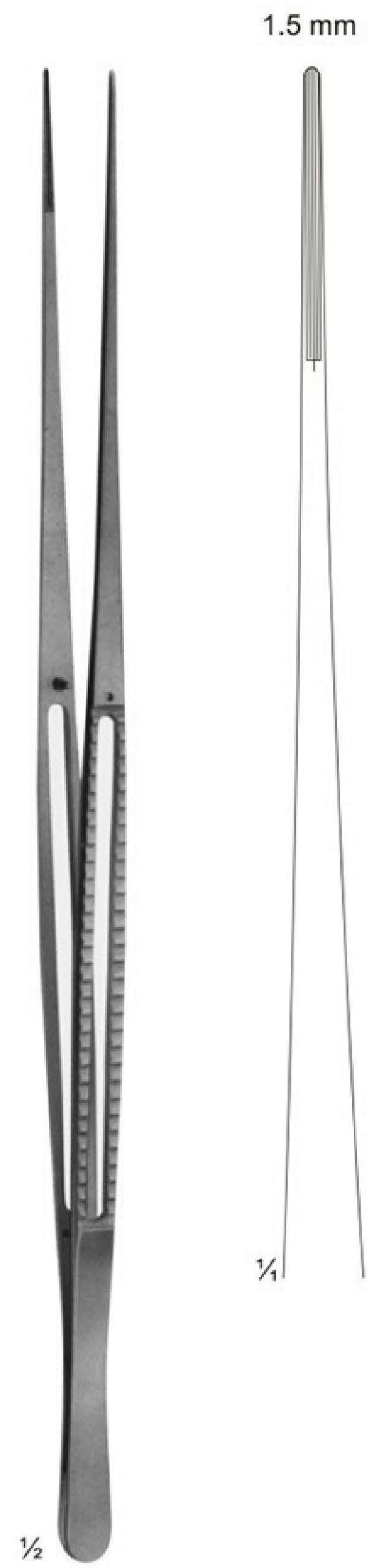

02-3393
300 mm

Forceps ATRAUMATA

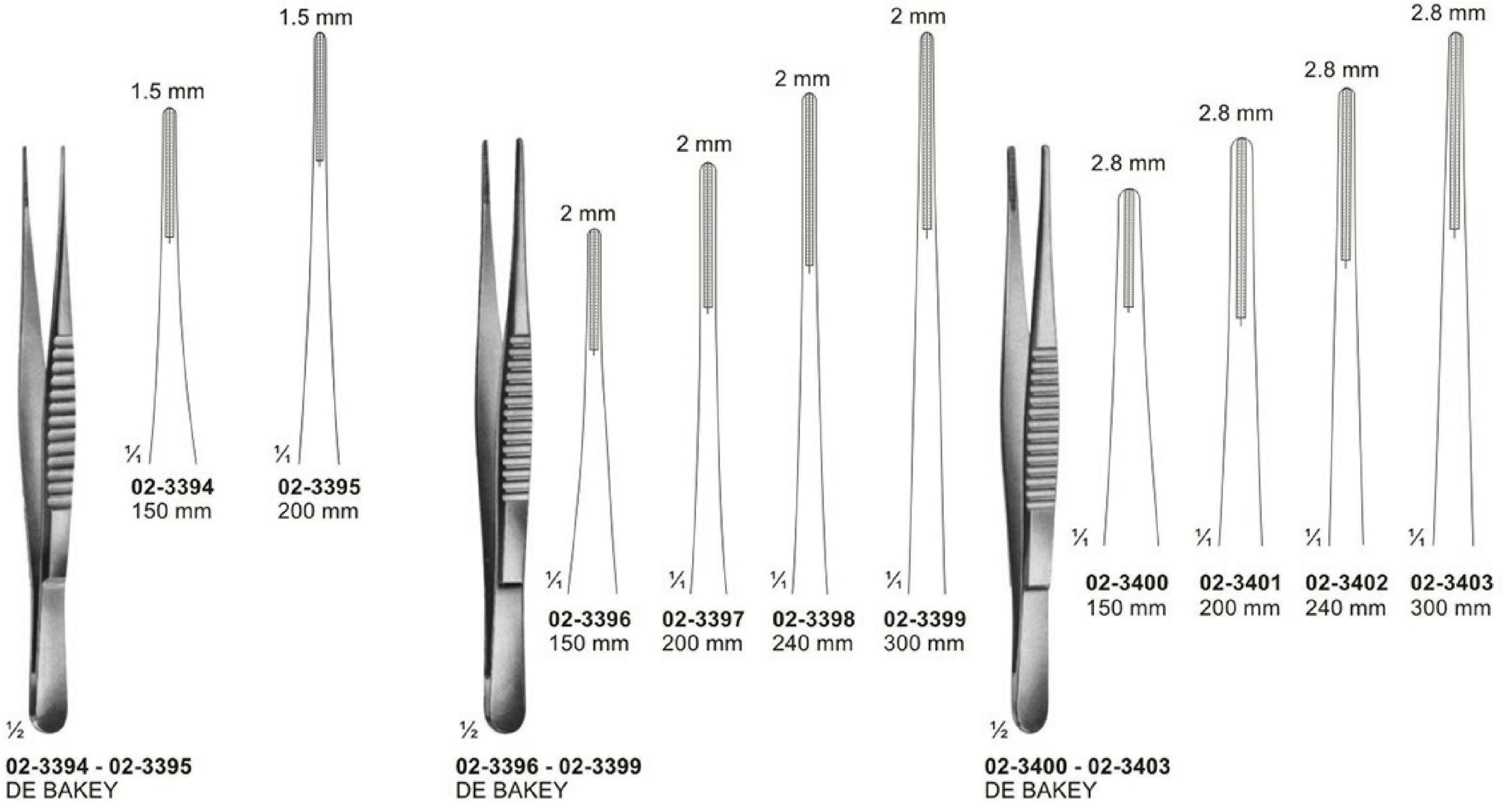

Forceps, Bayonet - Shaped, Angular

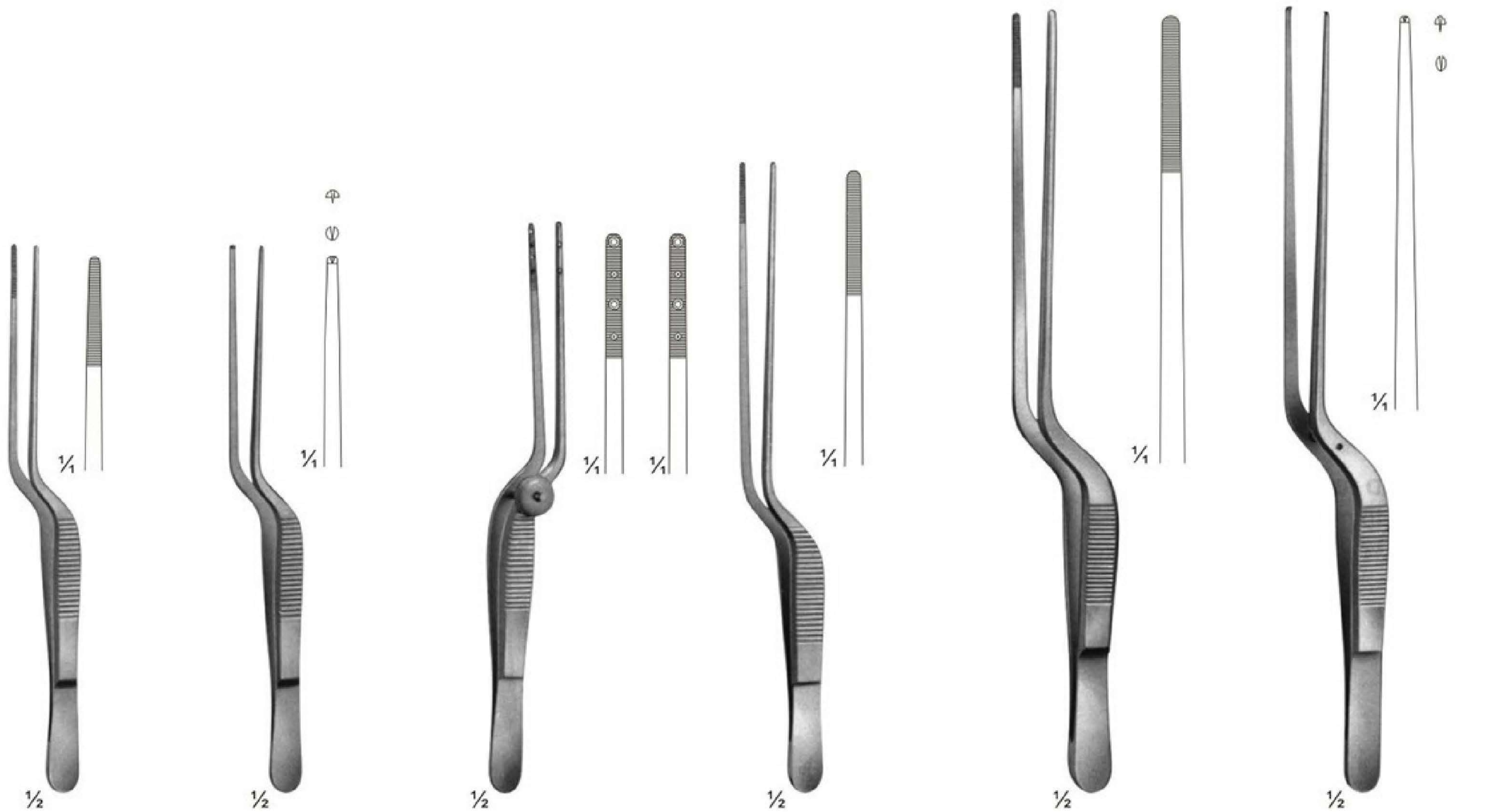

02-3409
LUCAE
140 mm

02-3410
LUCAE
1x2 teeth
140 mm

02-3411
COTTLE
Forceps with
jaws toothed
and serrated
140 mm

02-3412
JANSEN
160 mm

02-3413
GRUENWALD
200 mm

02-3414
1x2 teeth
200 mm

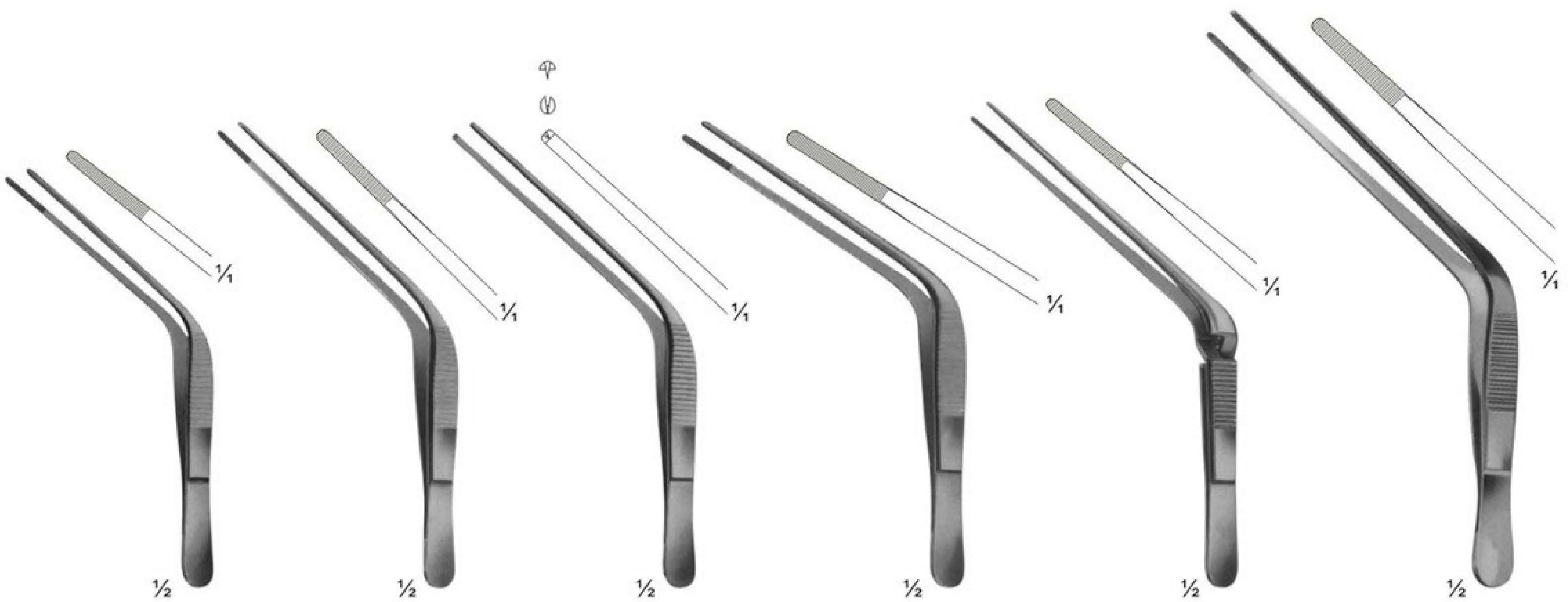

02-3415
TROELTSCH
100 mm

02-3416
TROELTSCH
115 mm

02-3417
TROELTSCH
1X2 teeth
115 mm

02-3418
WILDE
115 mm

02-3419
TROELTSCH
Cross action
120 mm

02-3420
TROELTSCH
140 mm

Delicate Tissue Forceps

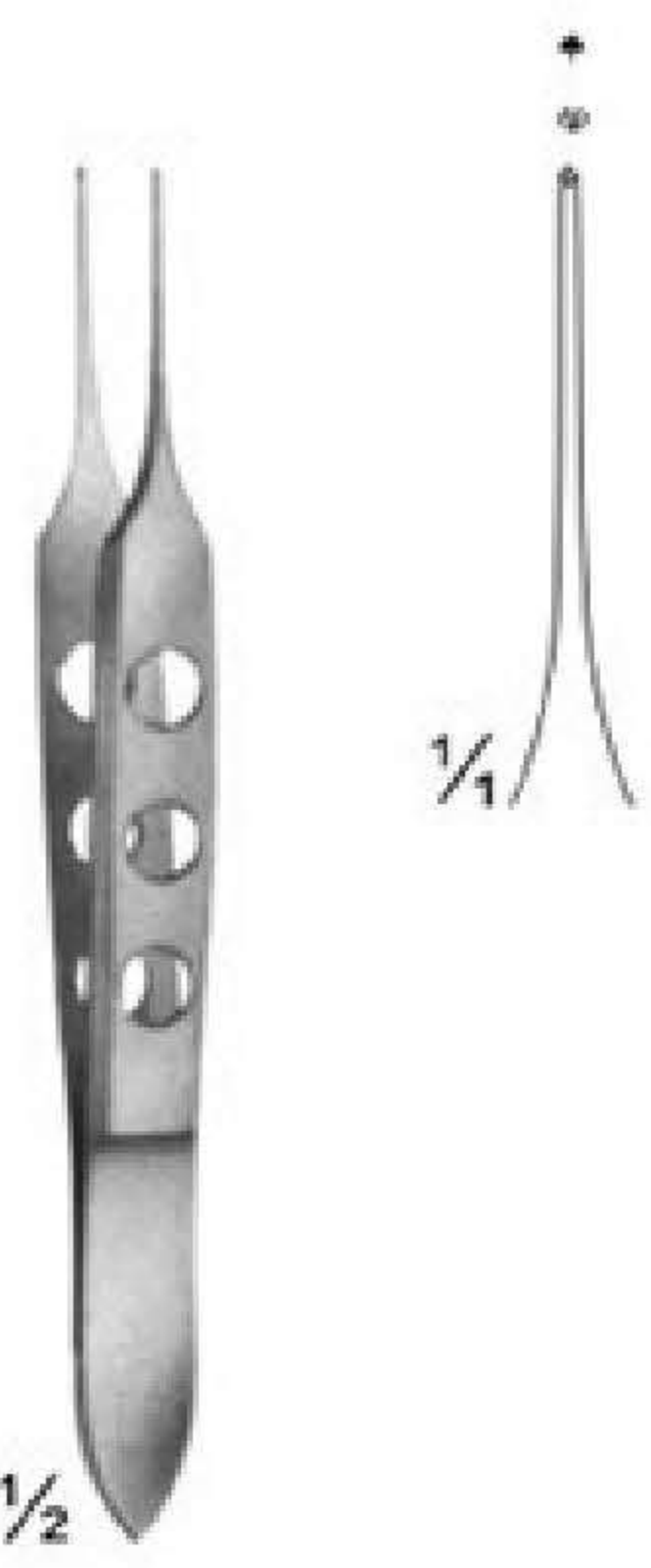

02-3421
BISHOP-HARMON
85 mm

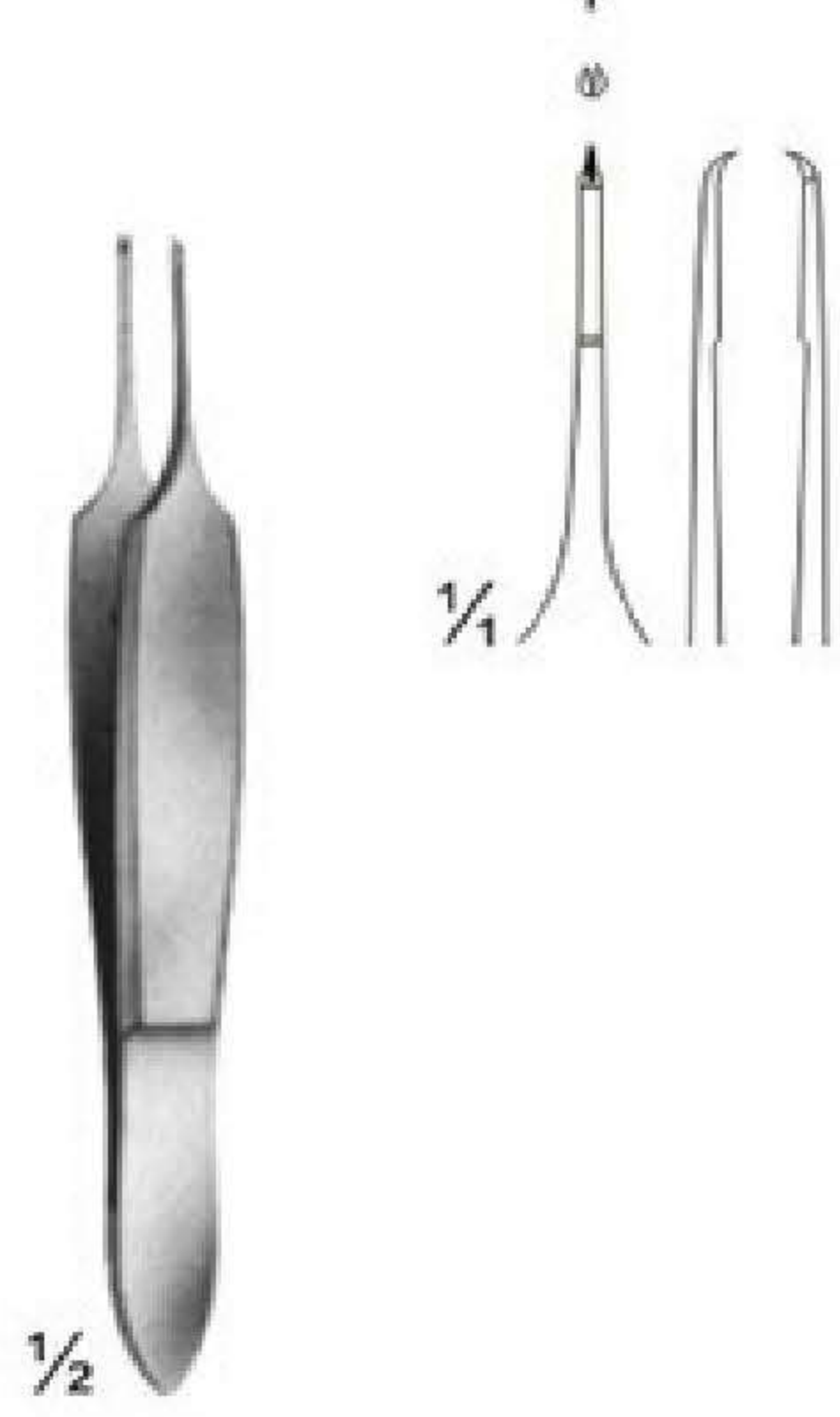

02-3422
ST.MARTIN
80 mm

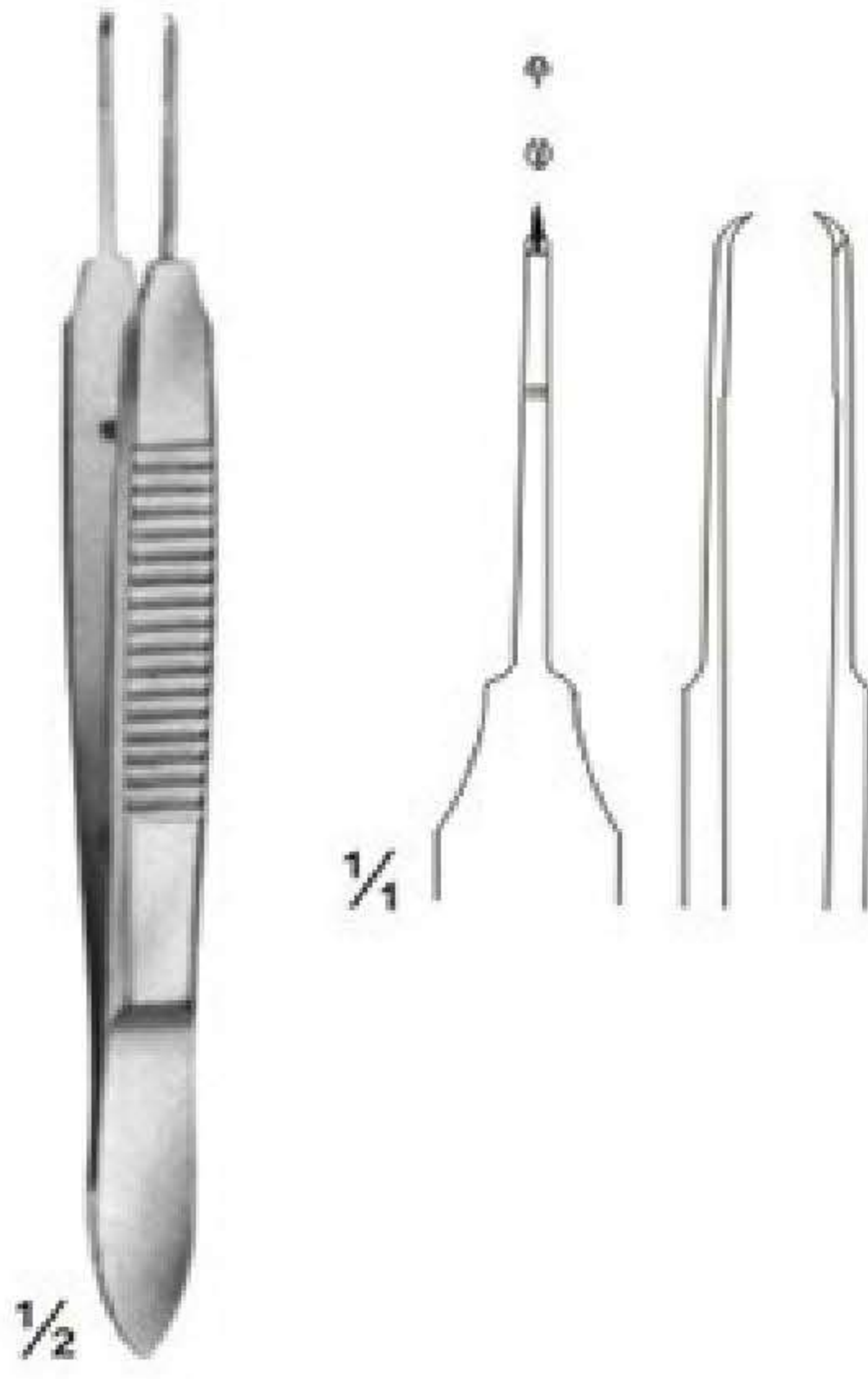

02-3423
CASTROVIEJO
teeth 0.9 mm
100 mm

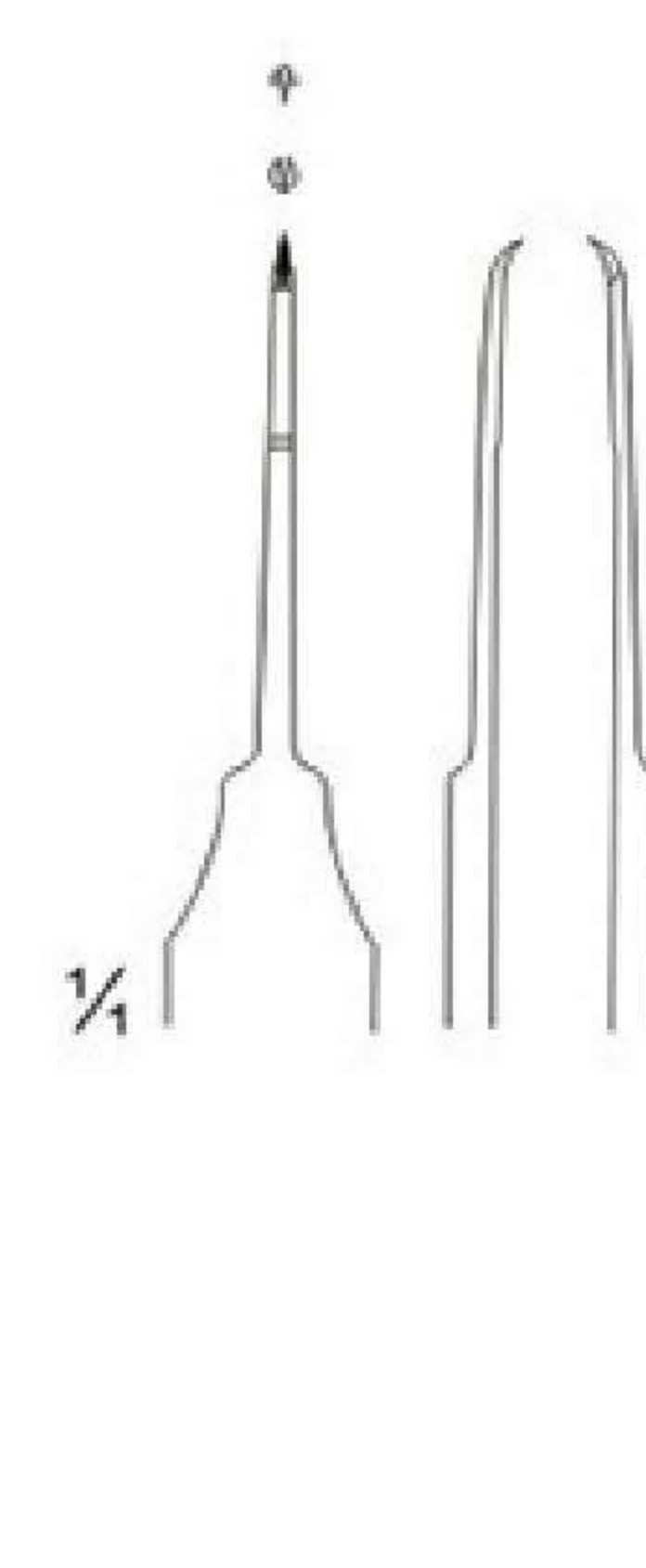

02-3424
CASTROVIEJO
teeth 0.5 mm
100 mm

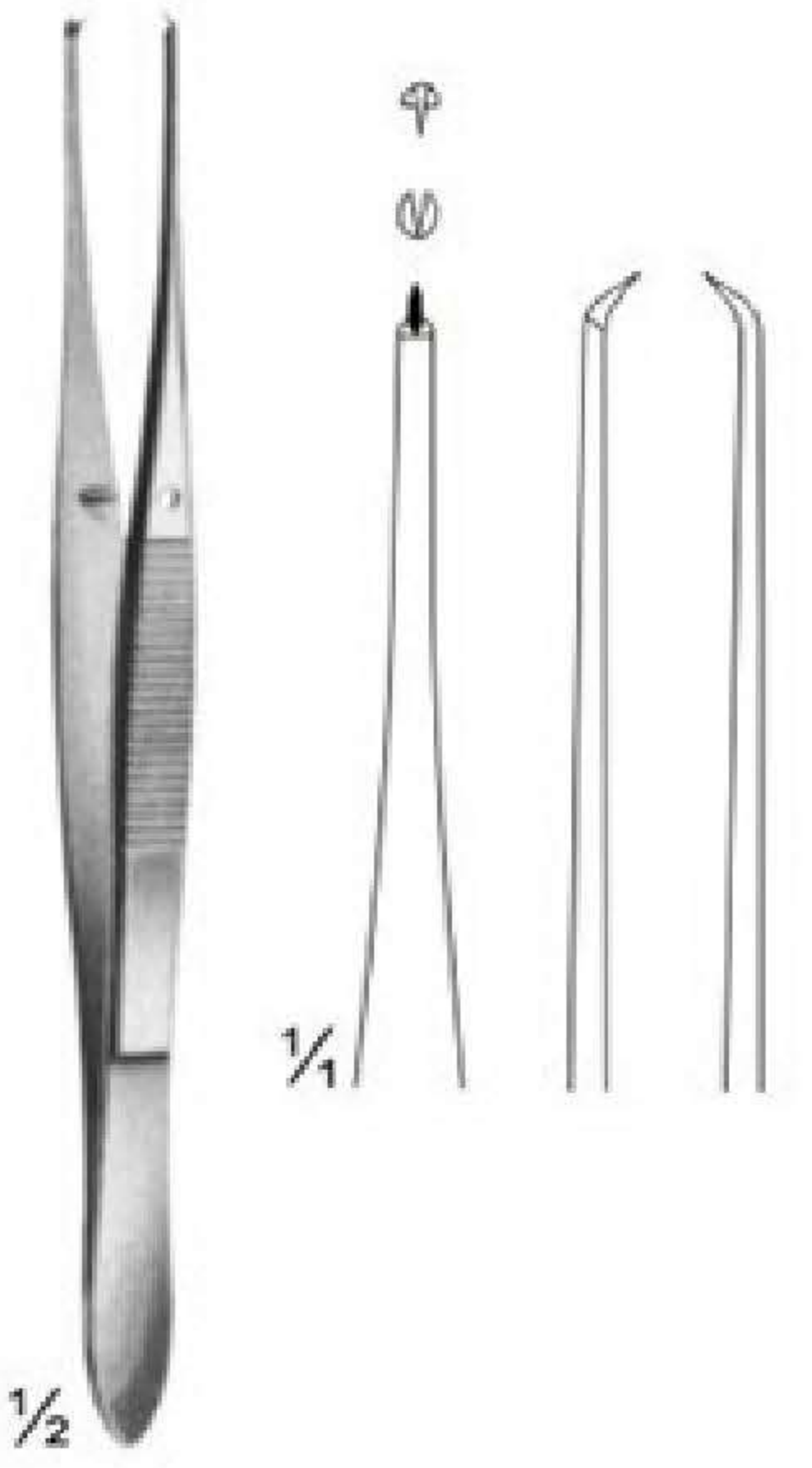

02-3425
ELSCHING
110 mm

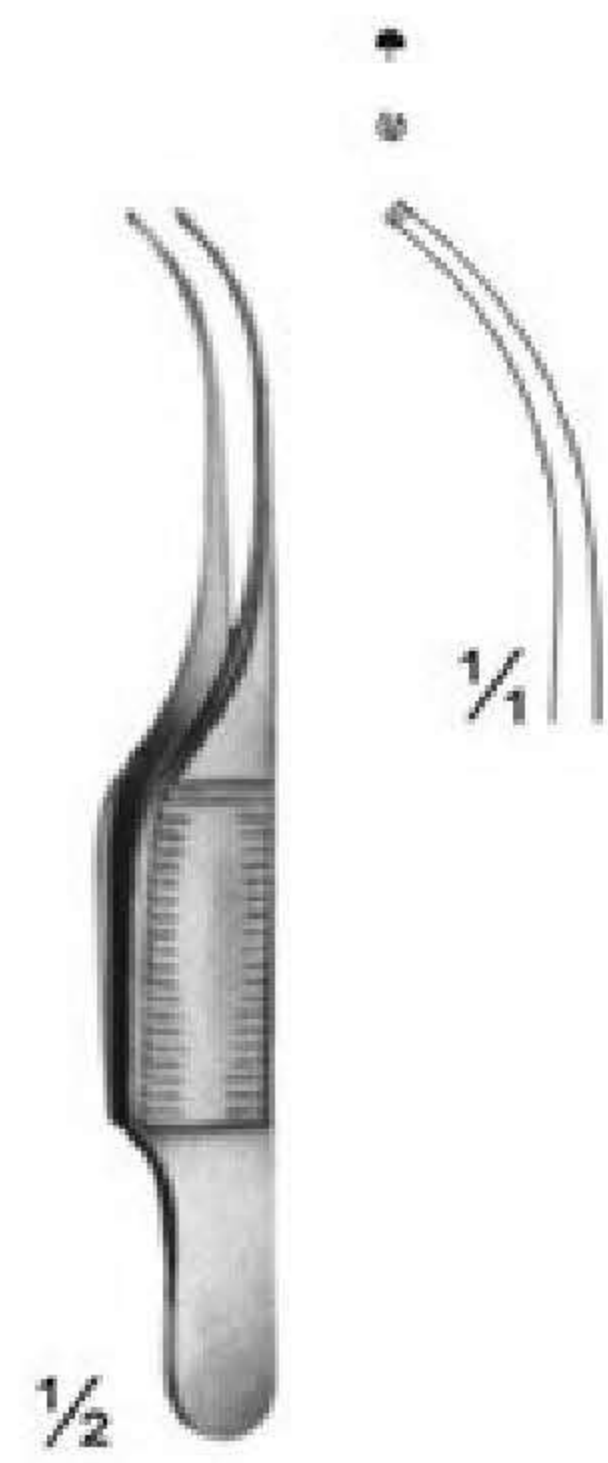

02-3426
GILL
75 mm

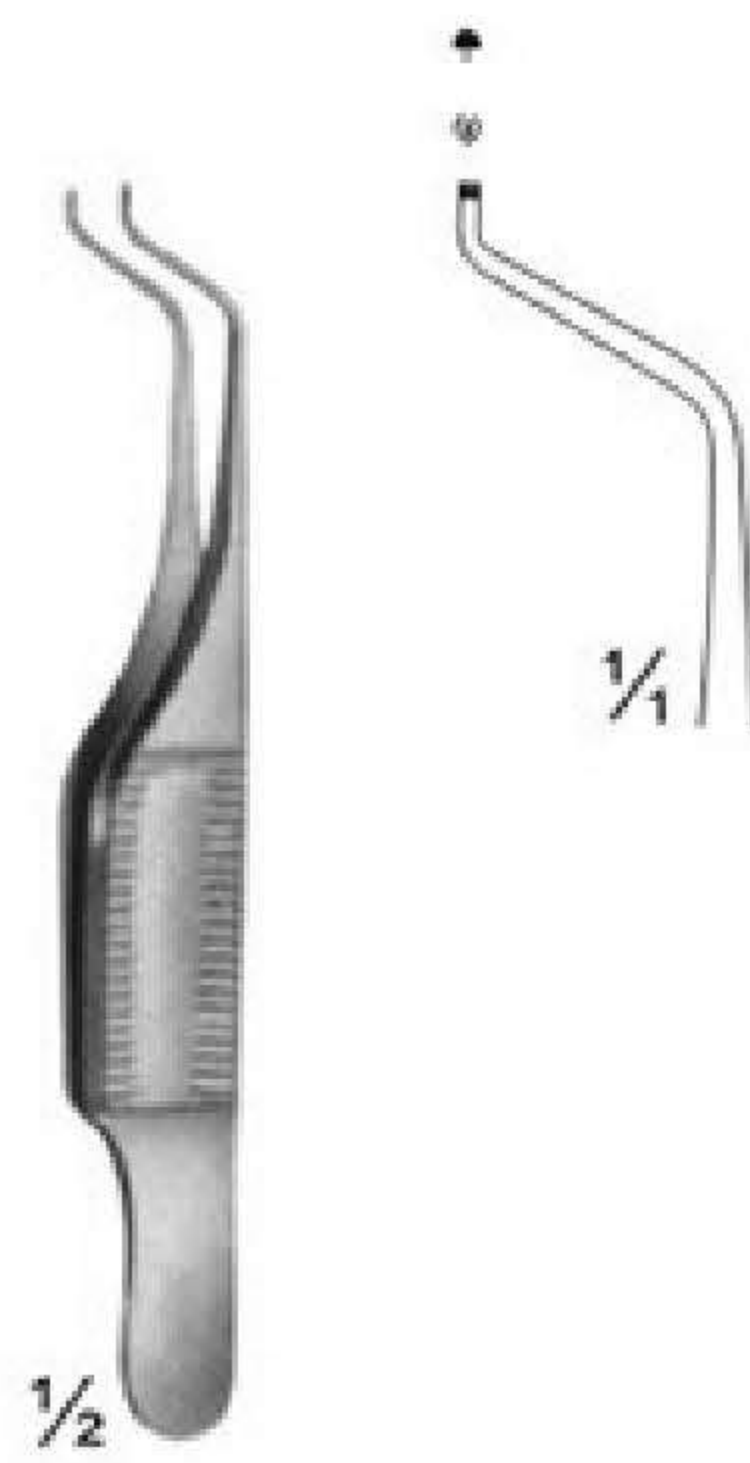

02-3427
GILL - HESS
75 mm

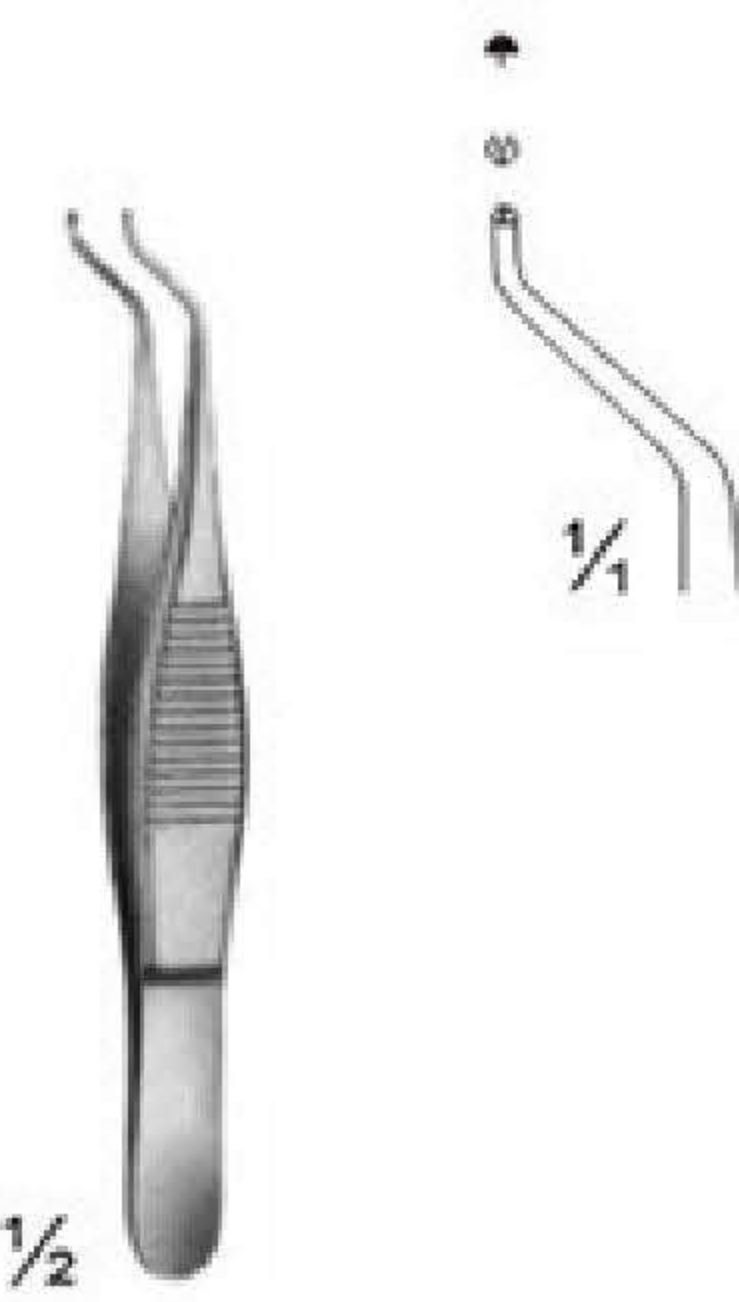

02-3428
HESS
70 mm

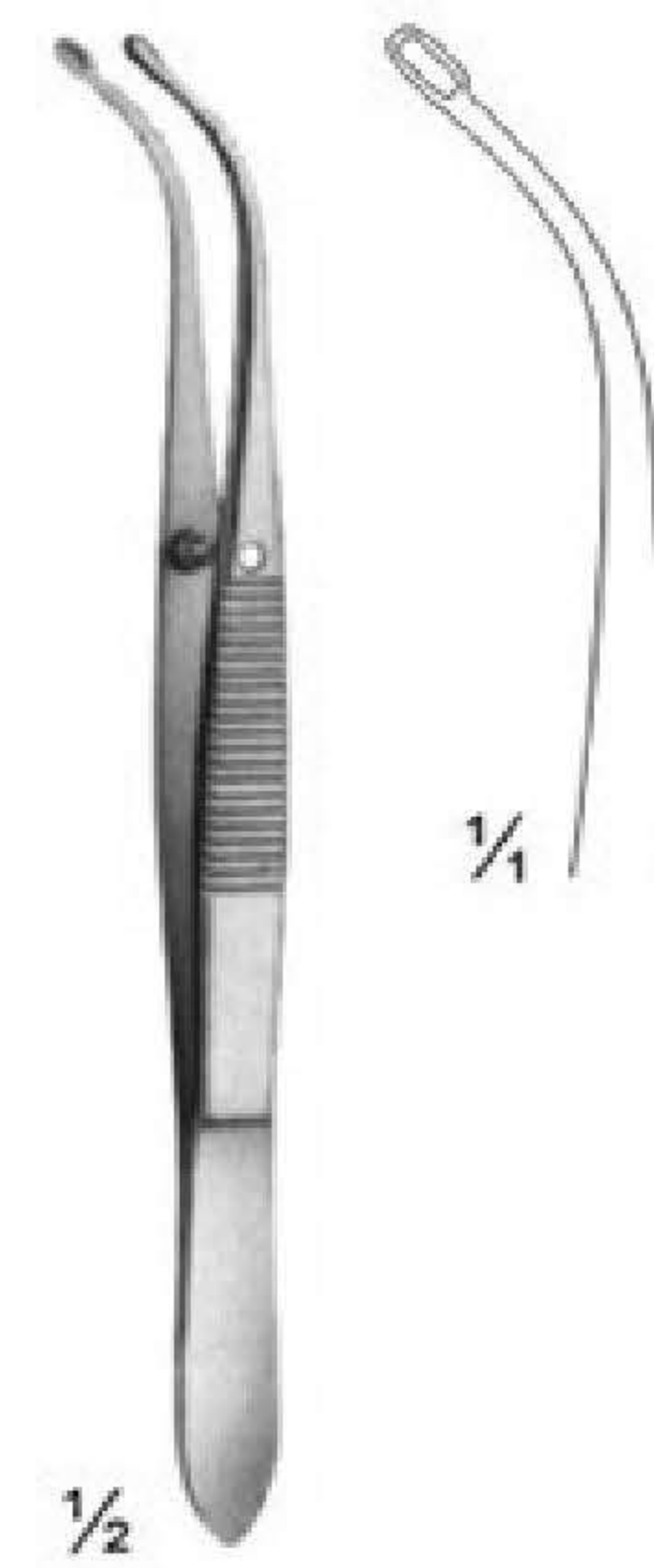

02-3429
ARRUGA
100 mm

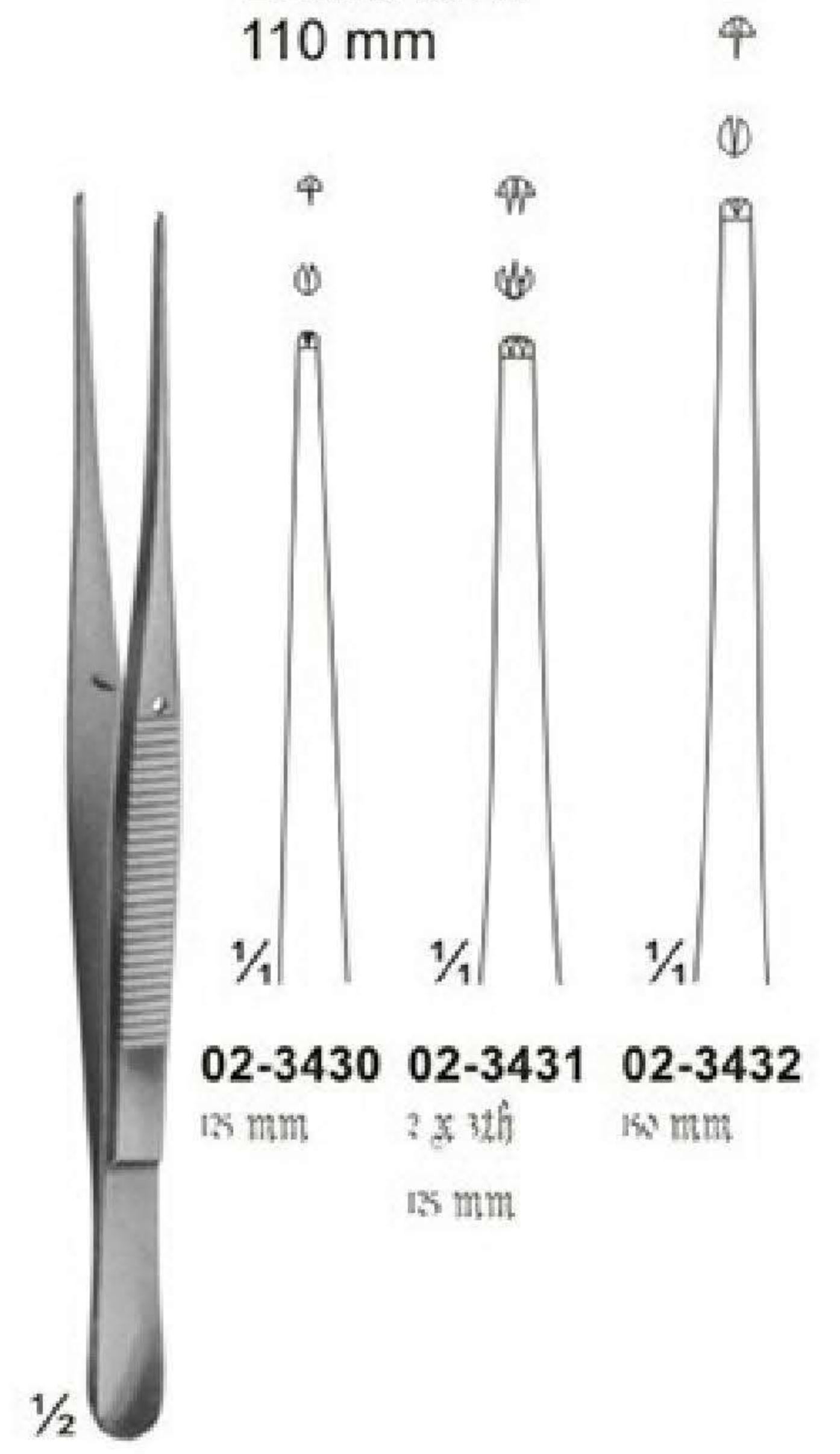

02-3430 - 02-3432
SEMKEN

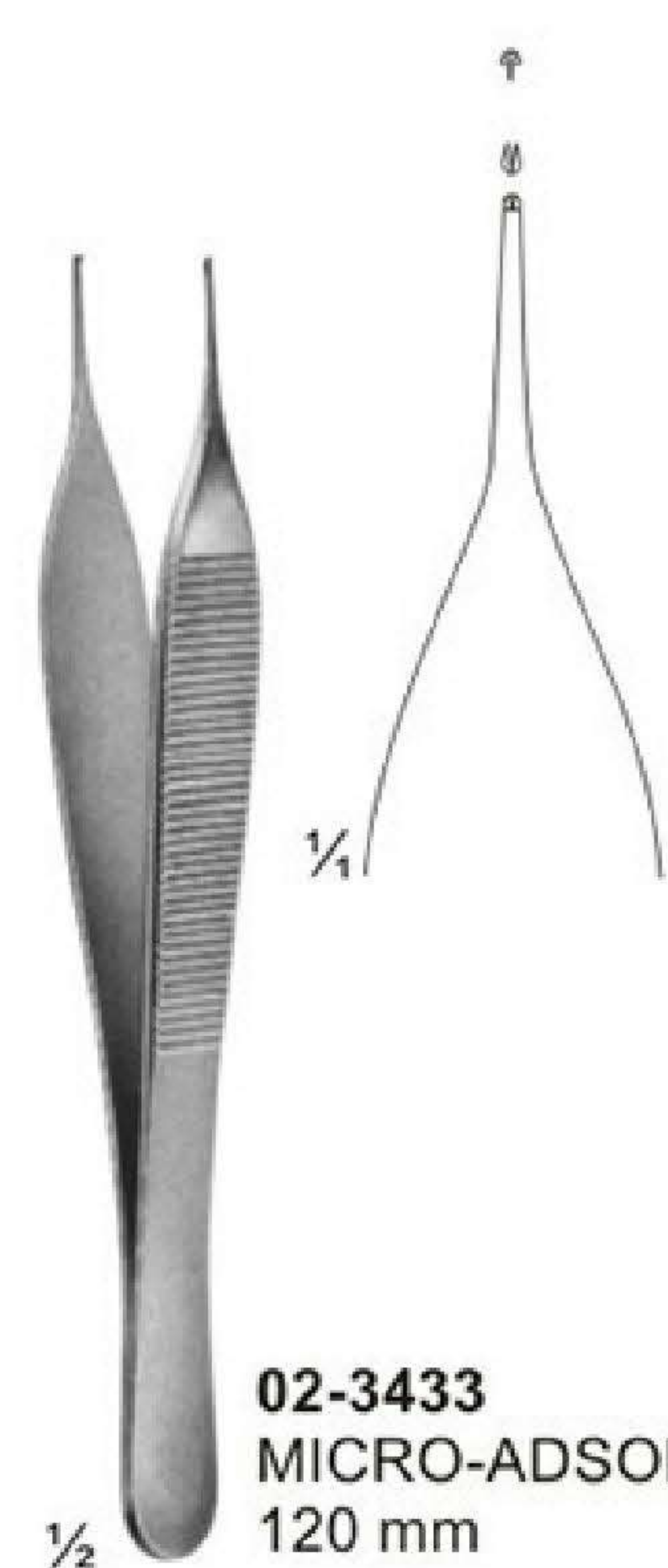

02-3433
MICRO-ADSON
120 mm

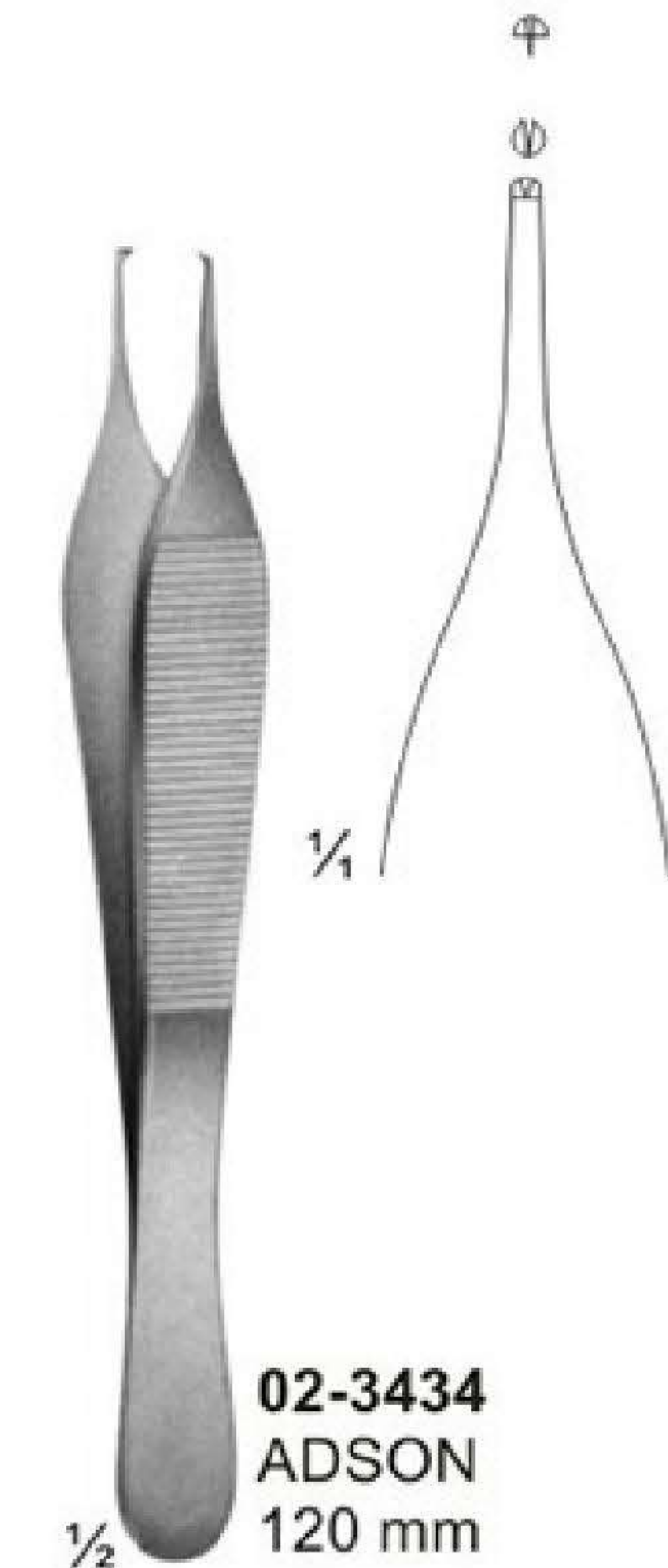

02-3434
ADSON
120 mm

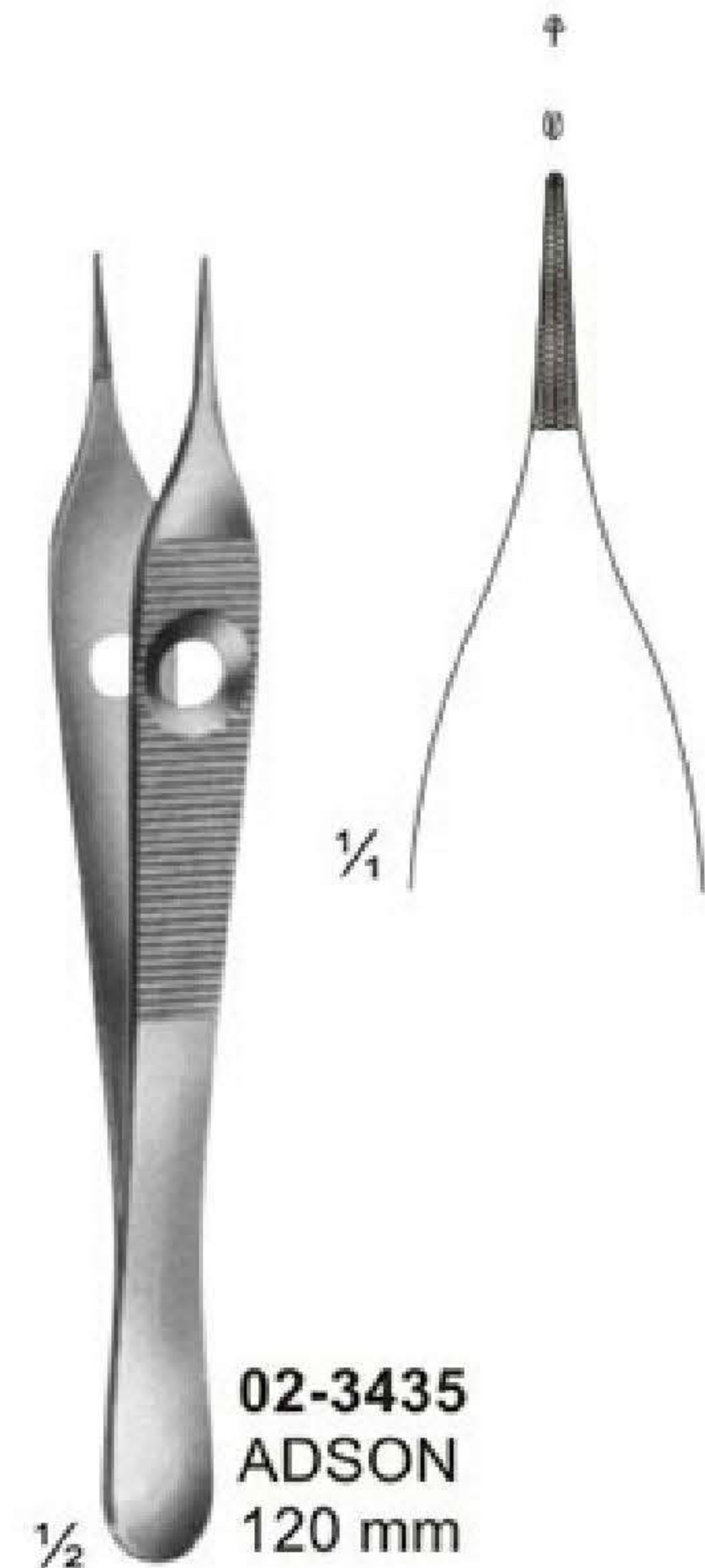

02-3435
ADSON
120 mm

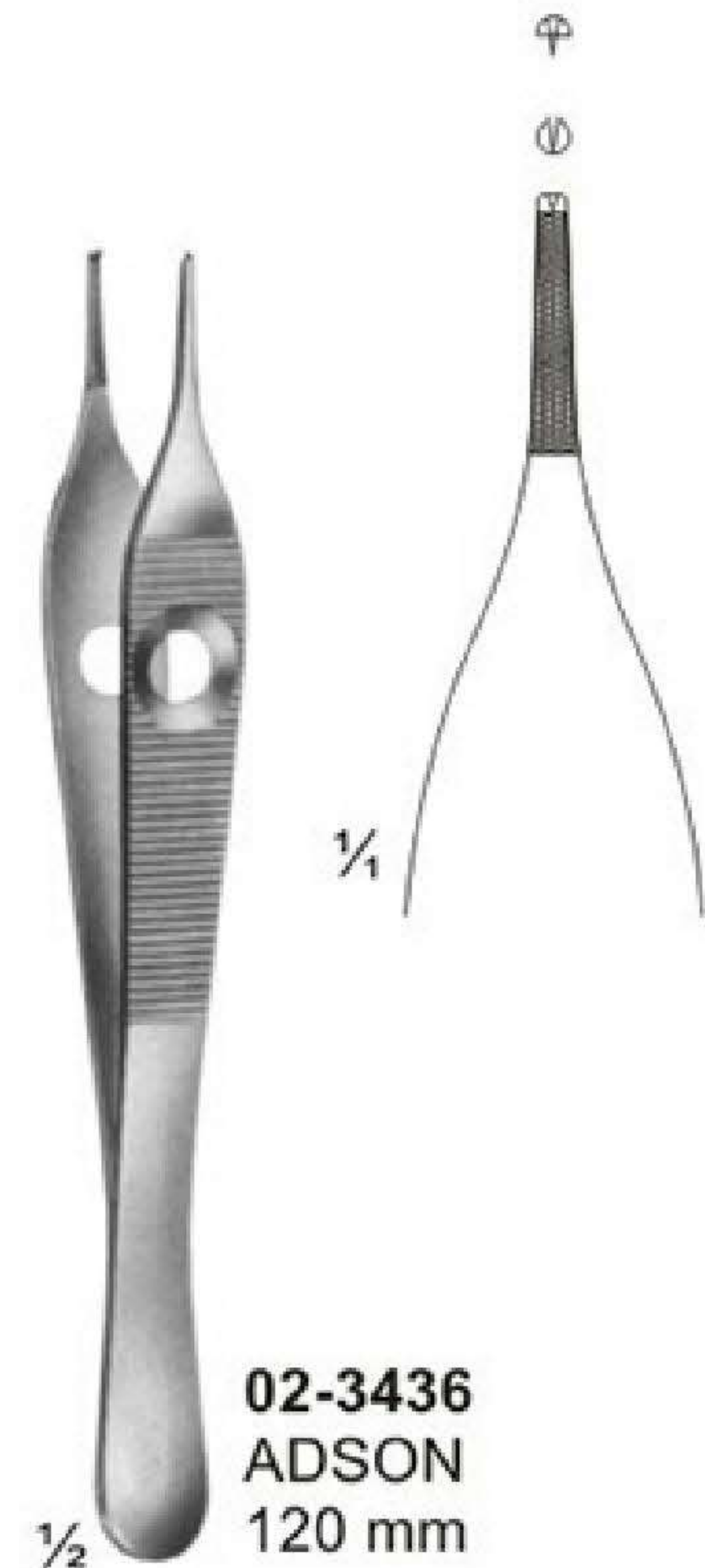

02-3436
ADSON
120 mm

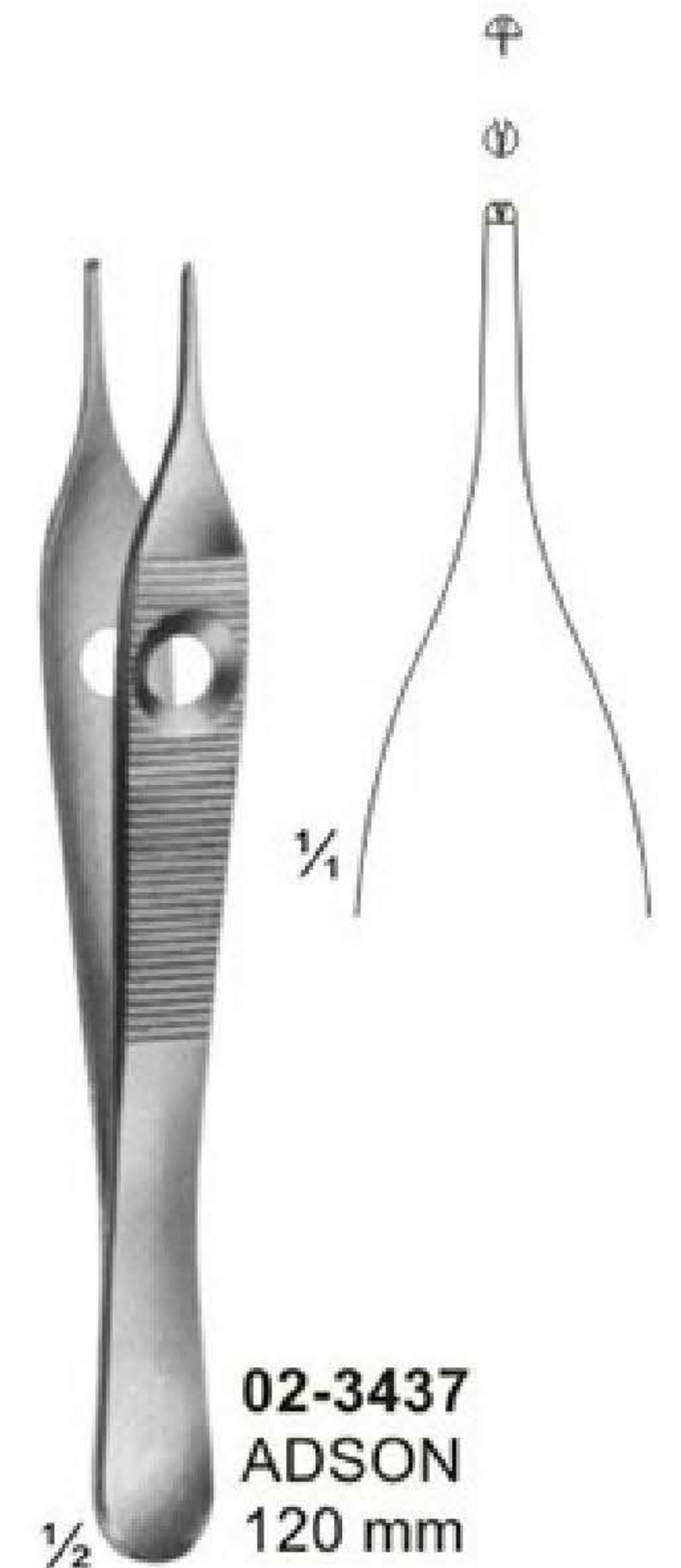

02-3437
ADSON
120 mm

Tissue Forceps

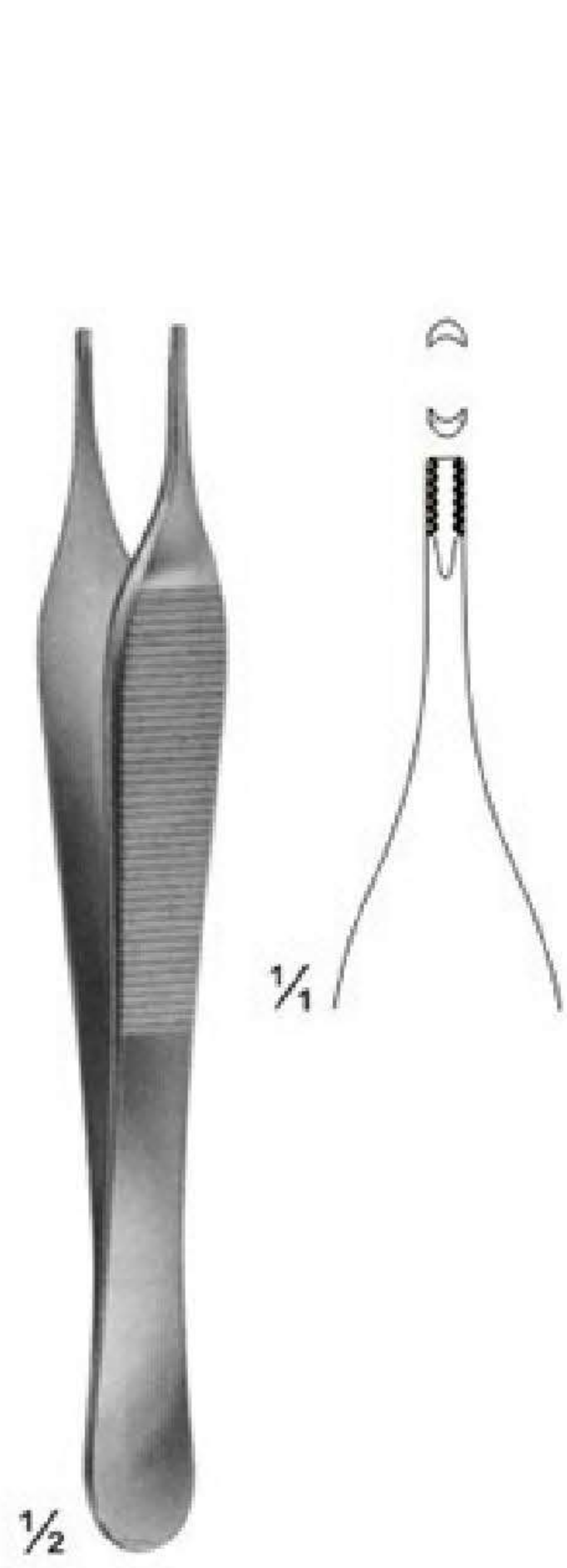

02-3438
 ADSON - BROWN
 Non-traumatic
 120 mm



02-3439
 BROWN
 150 mm



02-3440
 GRAEFE
 110 mm

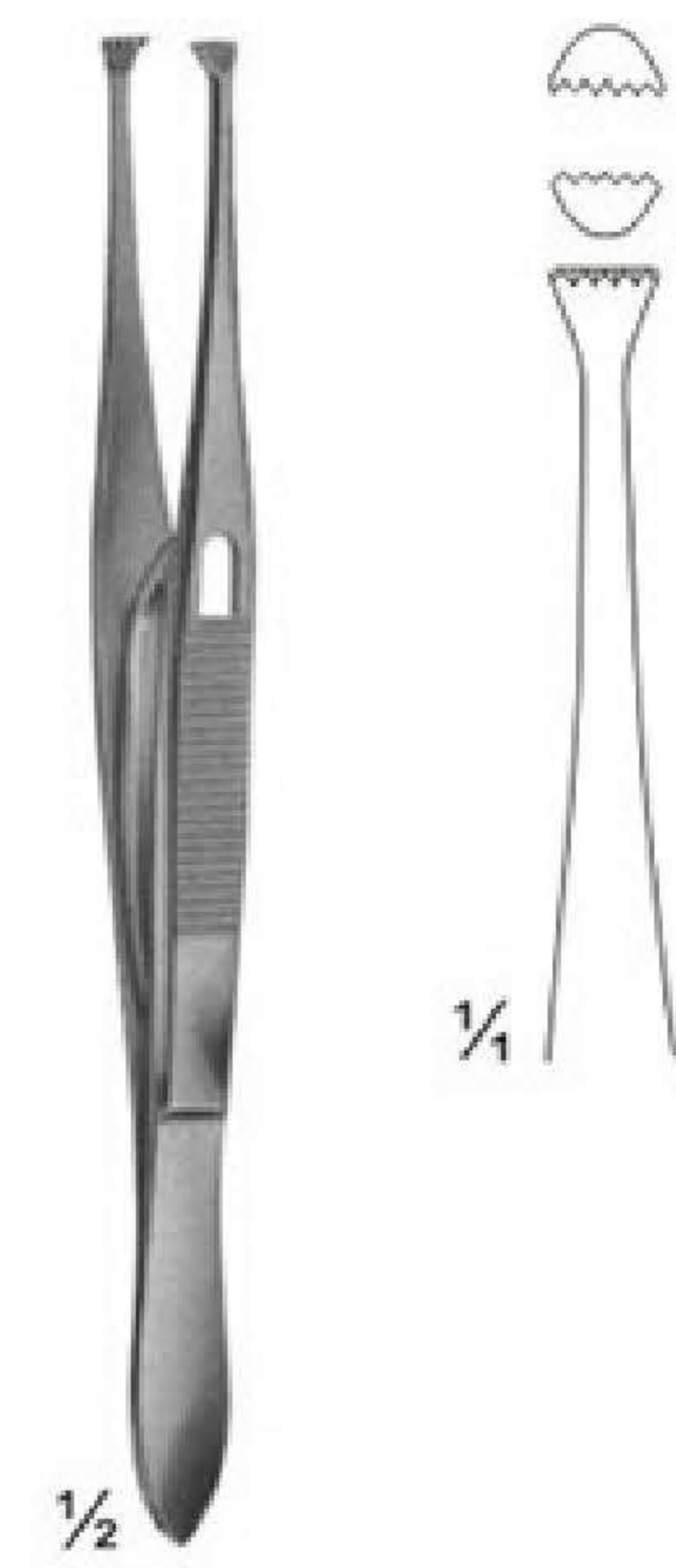

02-3441
 GRAEFE
 With Catch
 110 mm

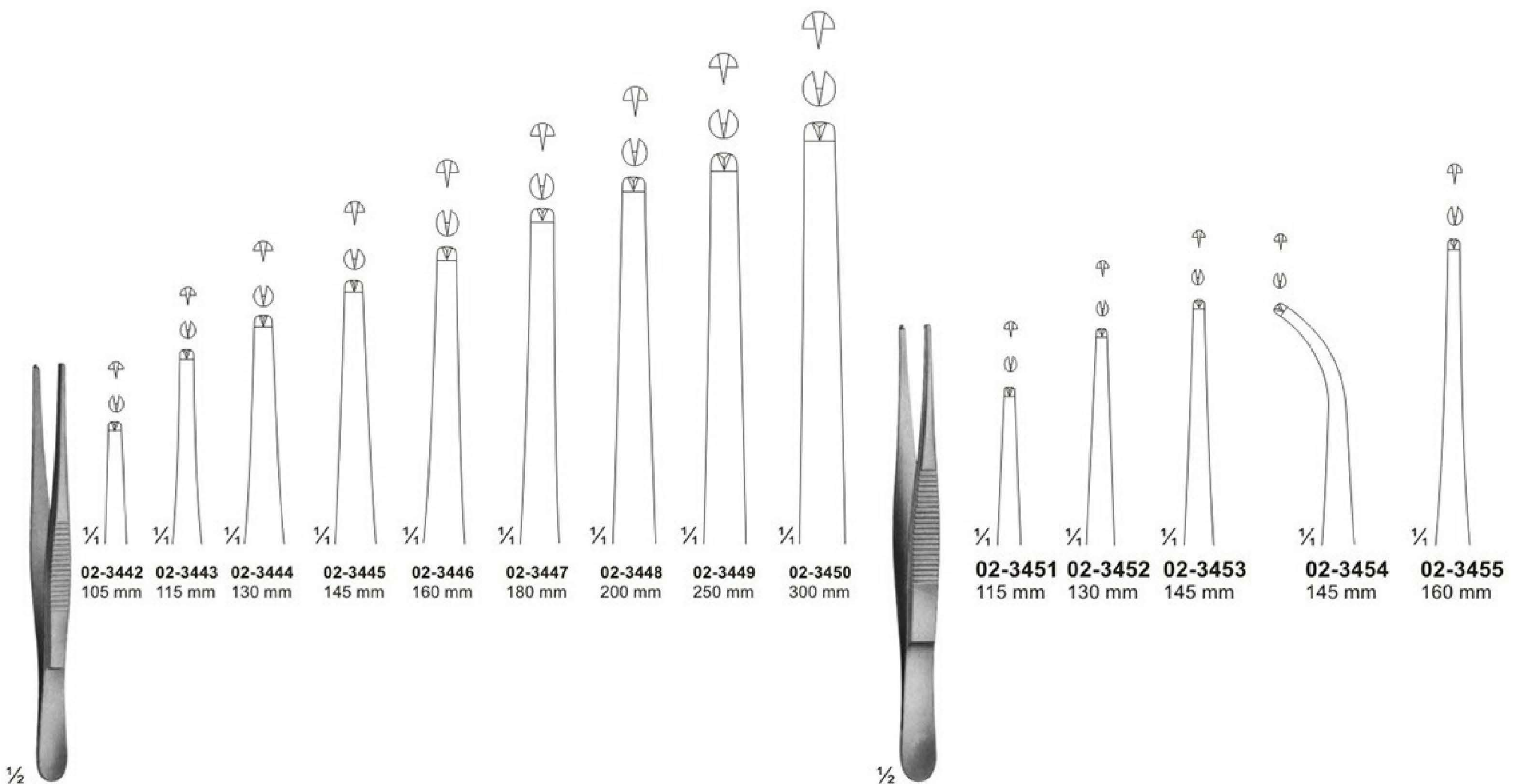

02-3442 - 02-3450
 STANDARD

02-3451 - 02-3455
 Medium

Tissue Forceps

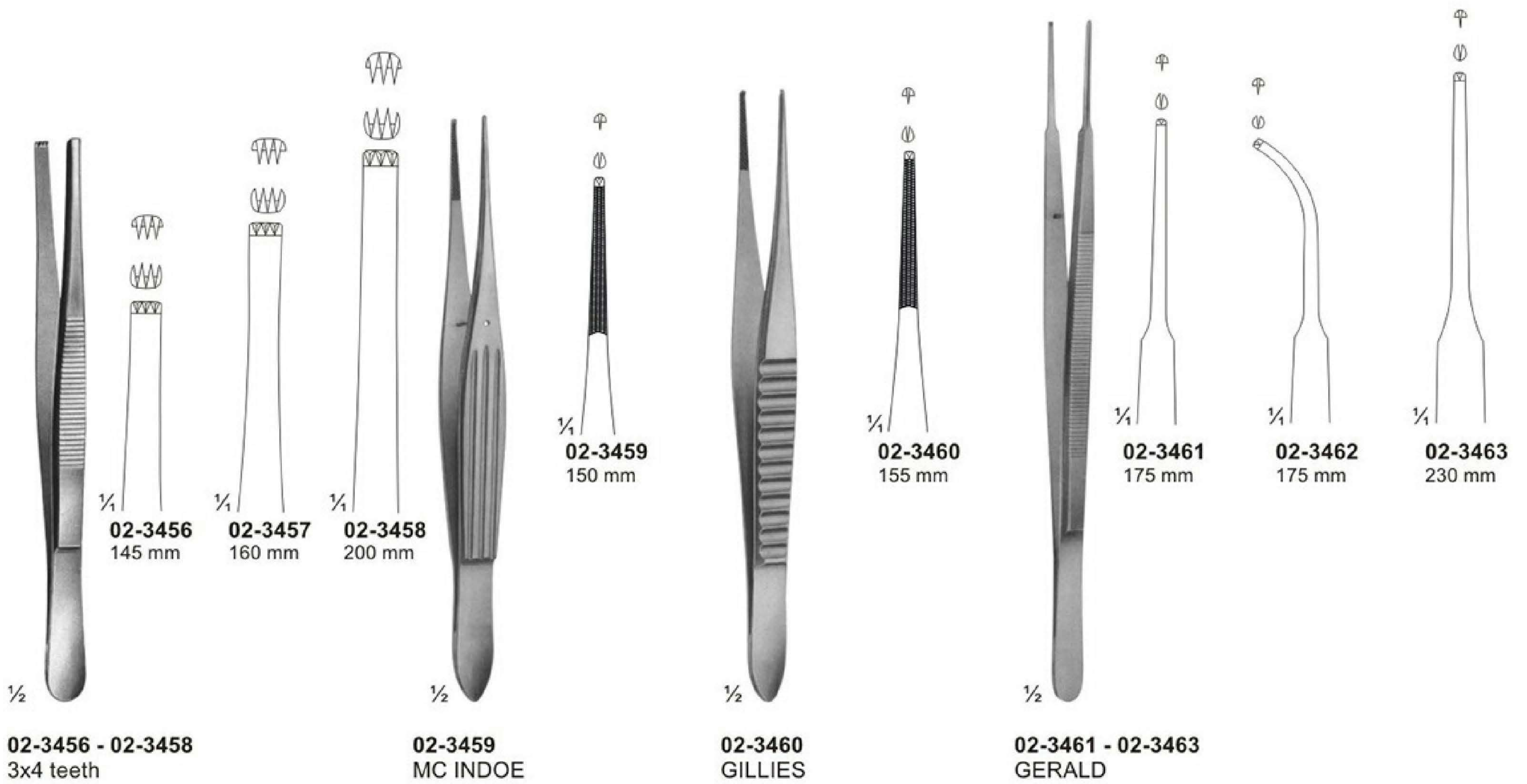

Tissue Forceps, Lung Dissecting Forceps, Intestinal Forceps

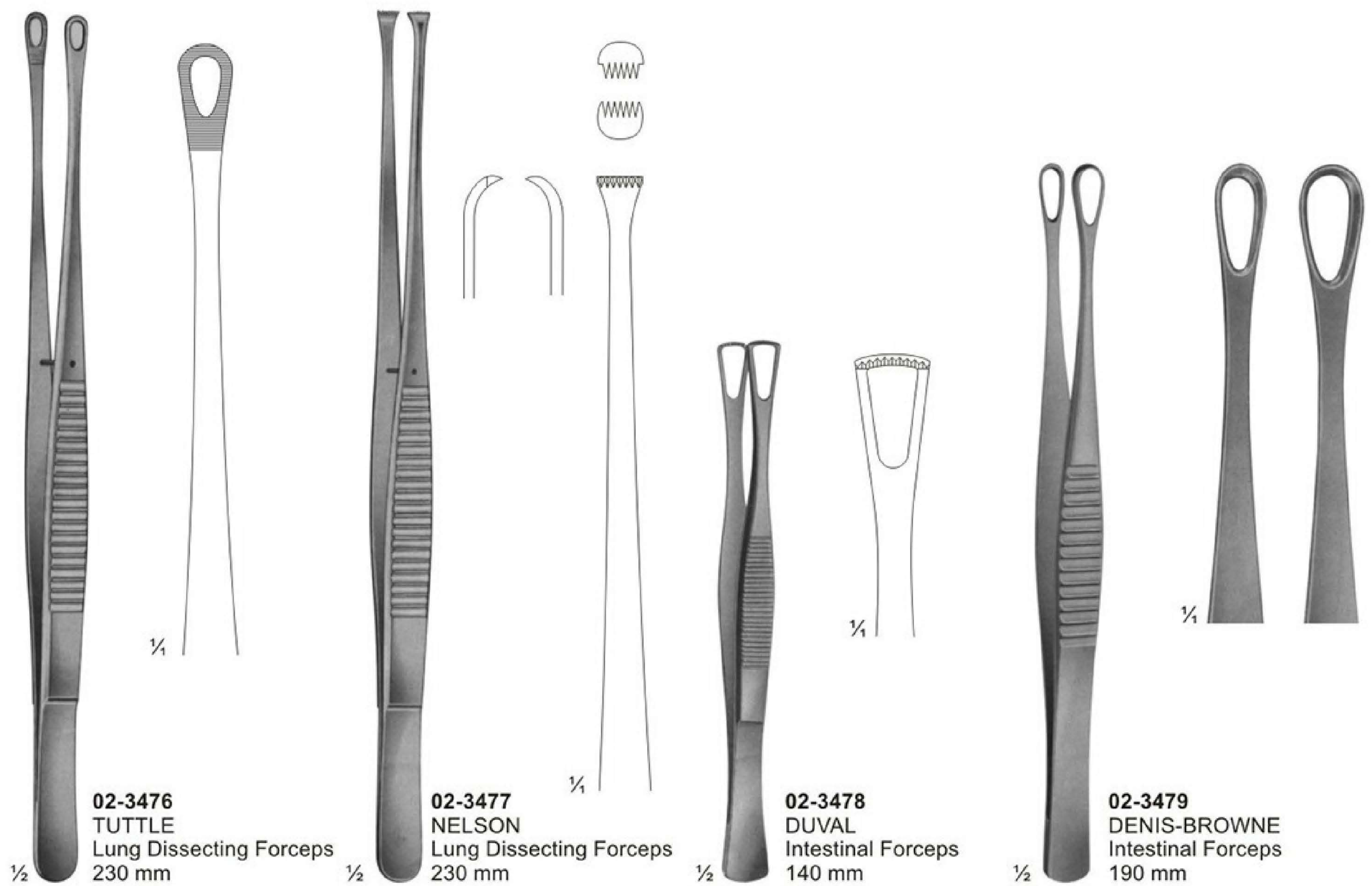
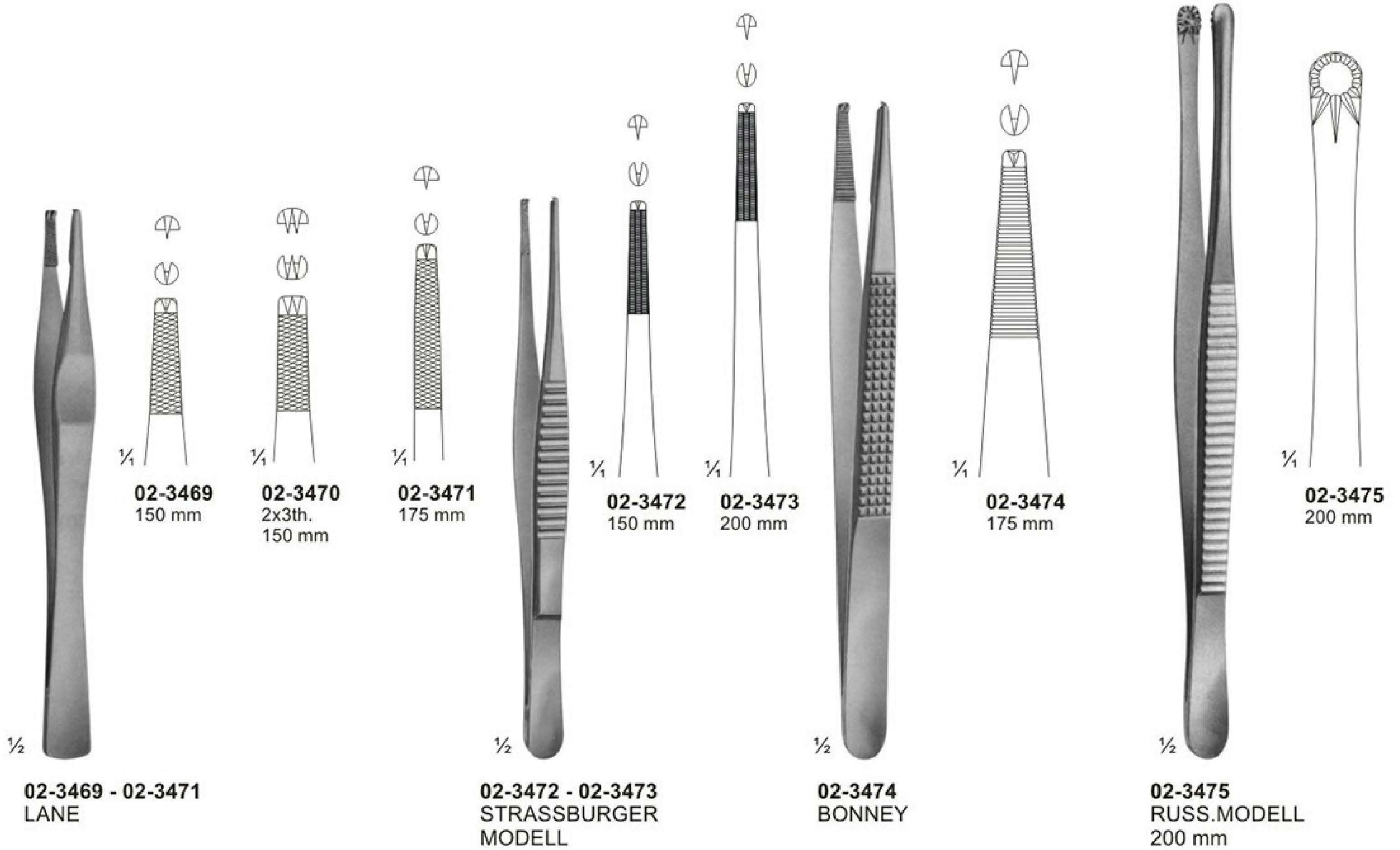

Splinter and Cilia Forceps

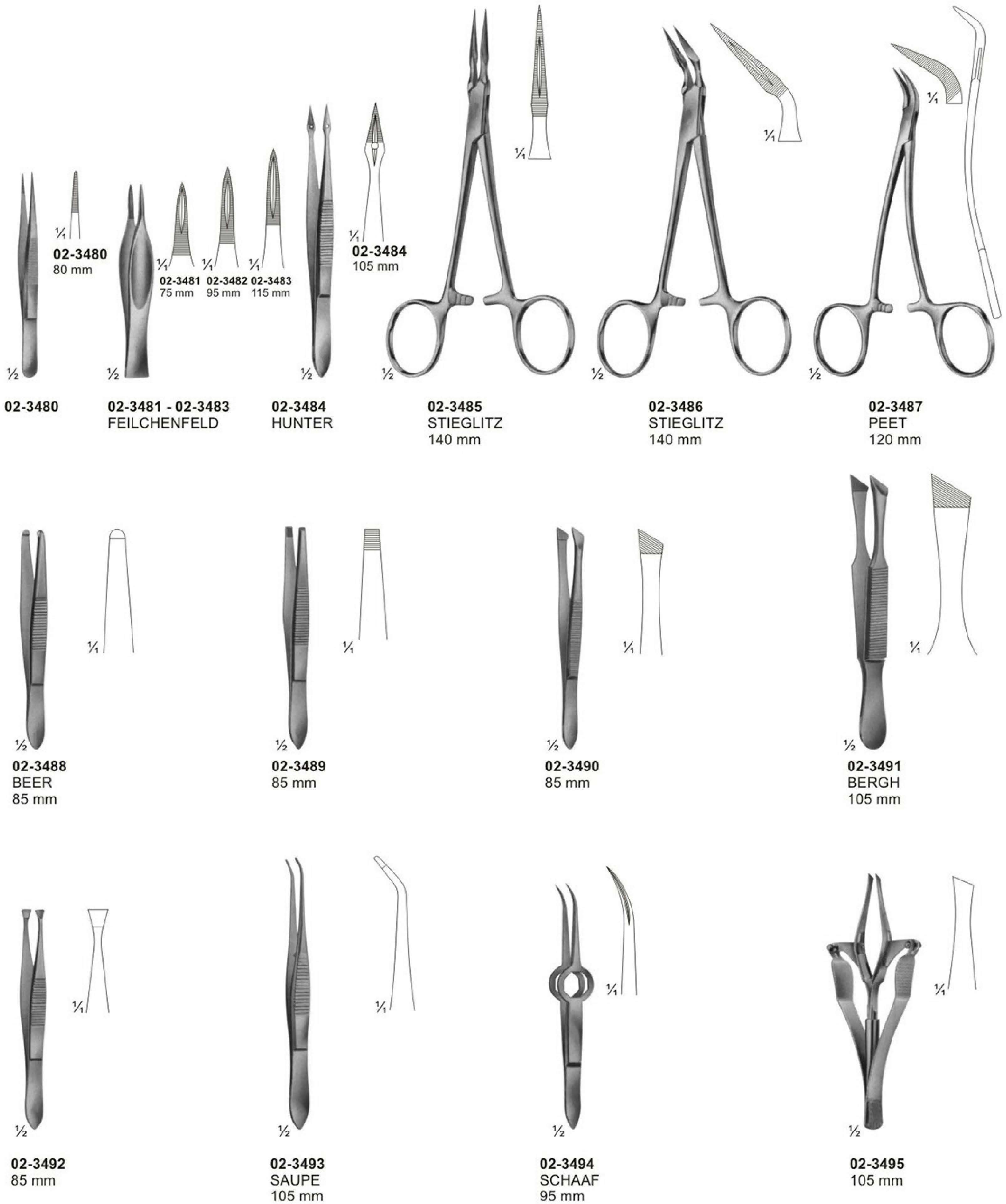

Sponge and Dressing Forceps

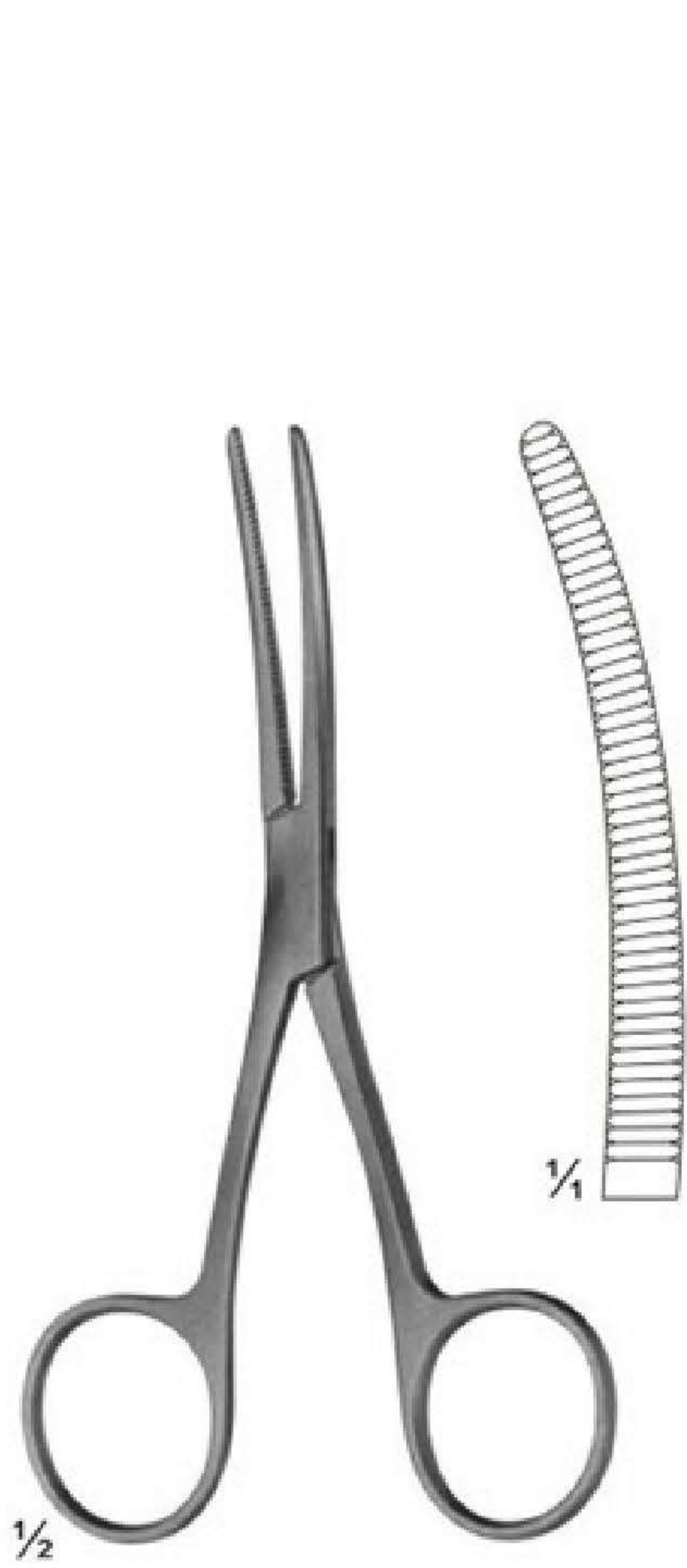

02-3496
BRYANT
130 mm



02-3497 - 02-3499
LISTER
Sinus Forceps

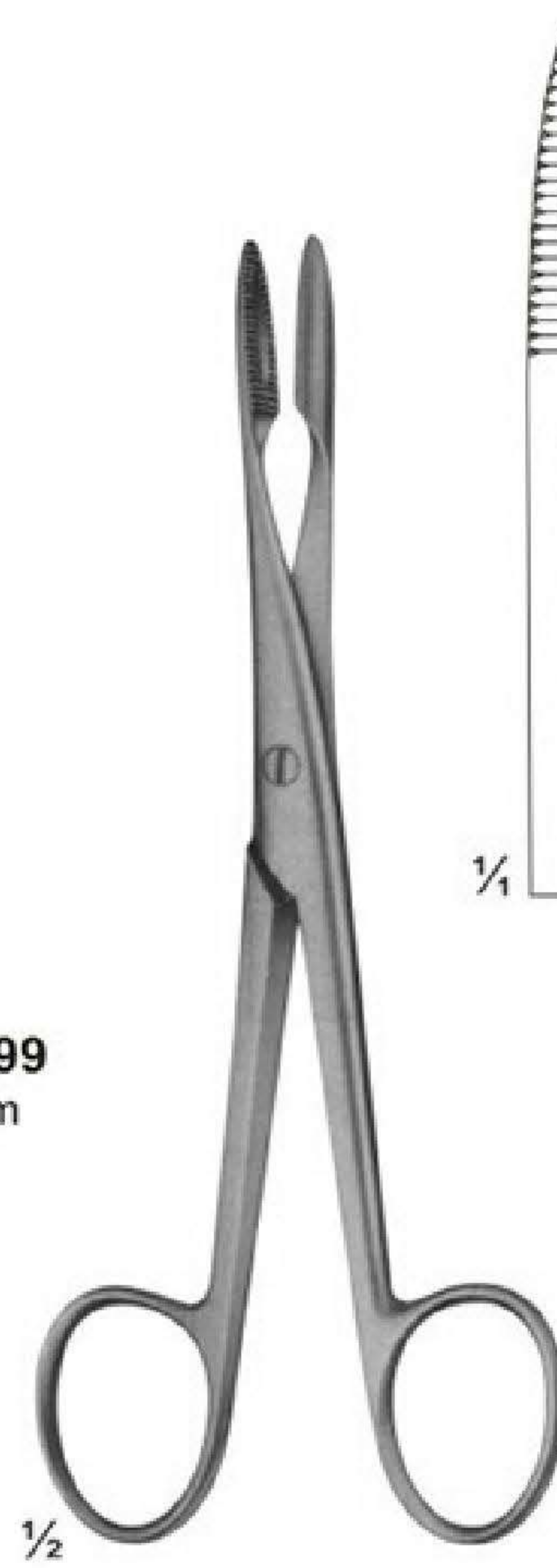

02-3500
Without Ratchet
145 mm

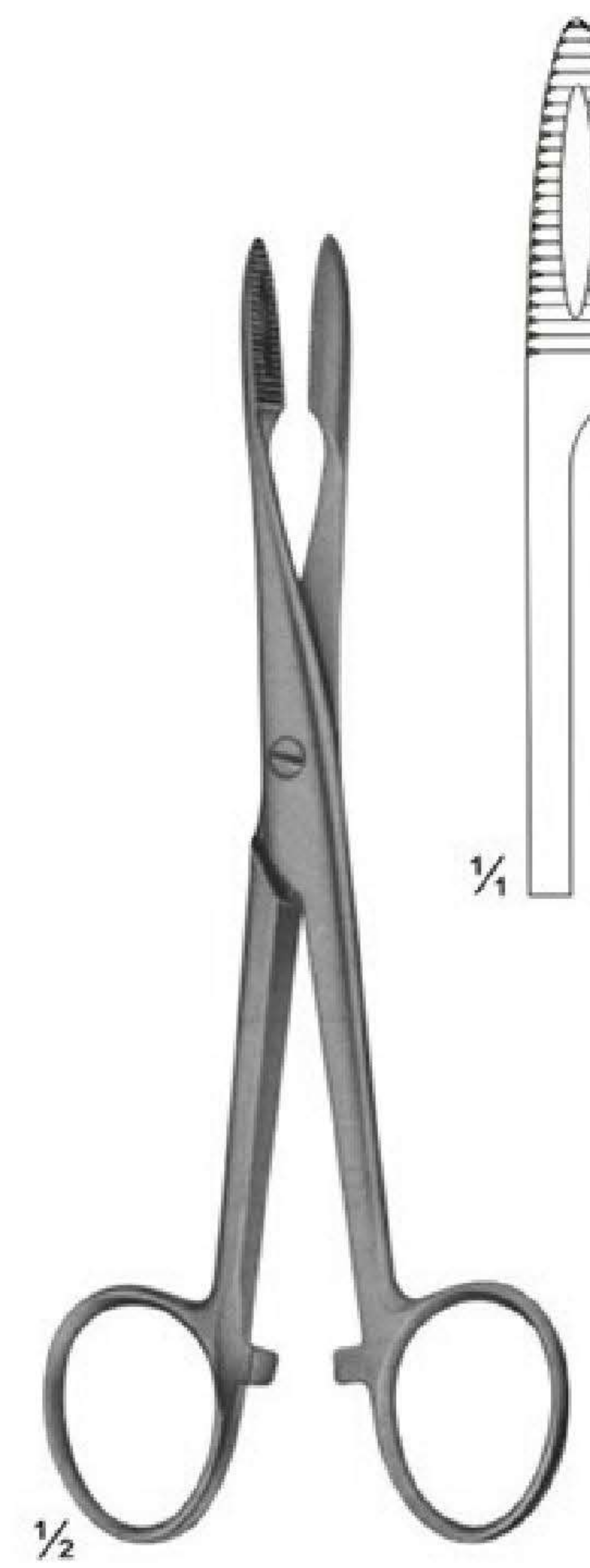

02-3501
With Ratchet
145 mm

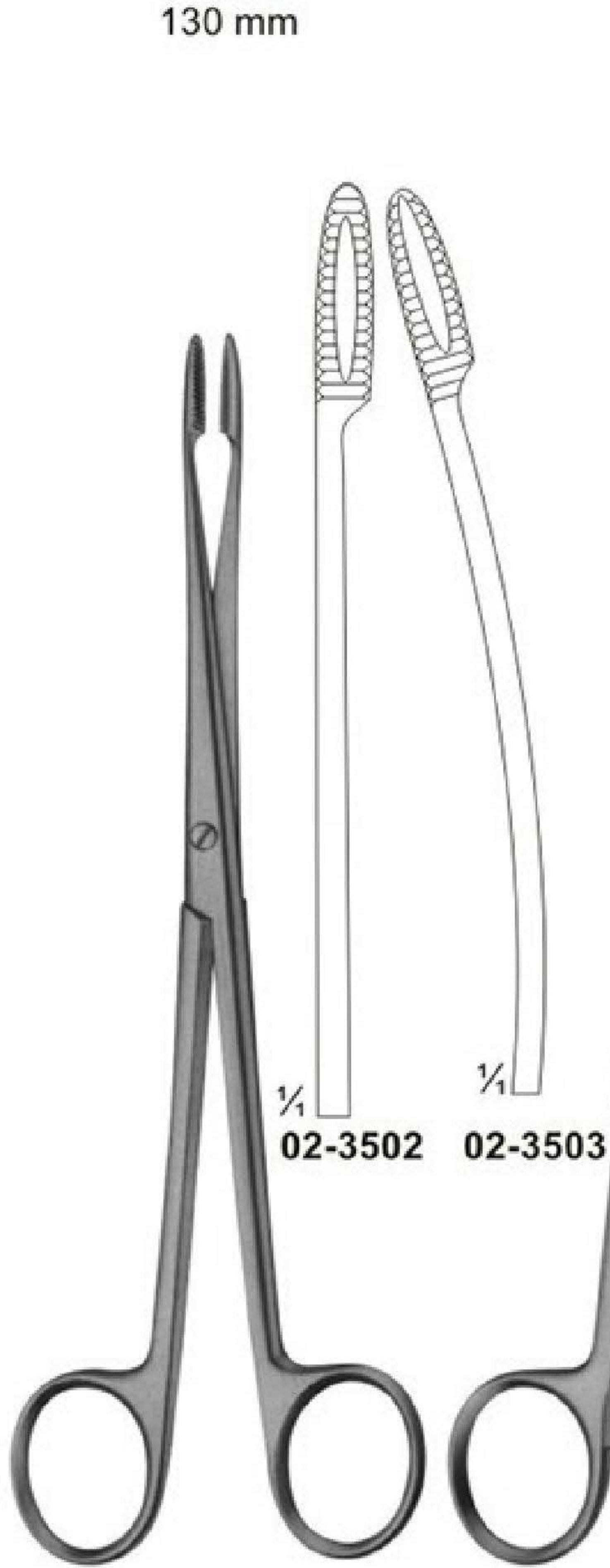

02-3502 - 02-3503
GROSS
Without Ratchet
180 mm

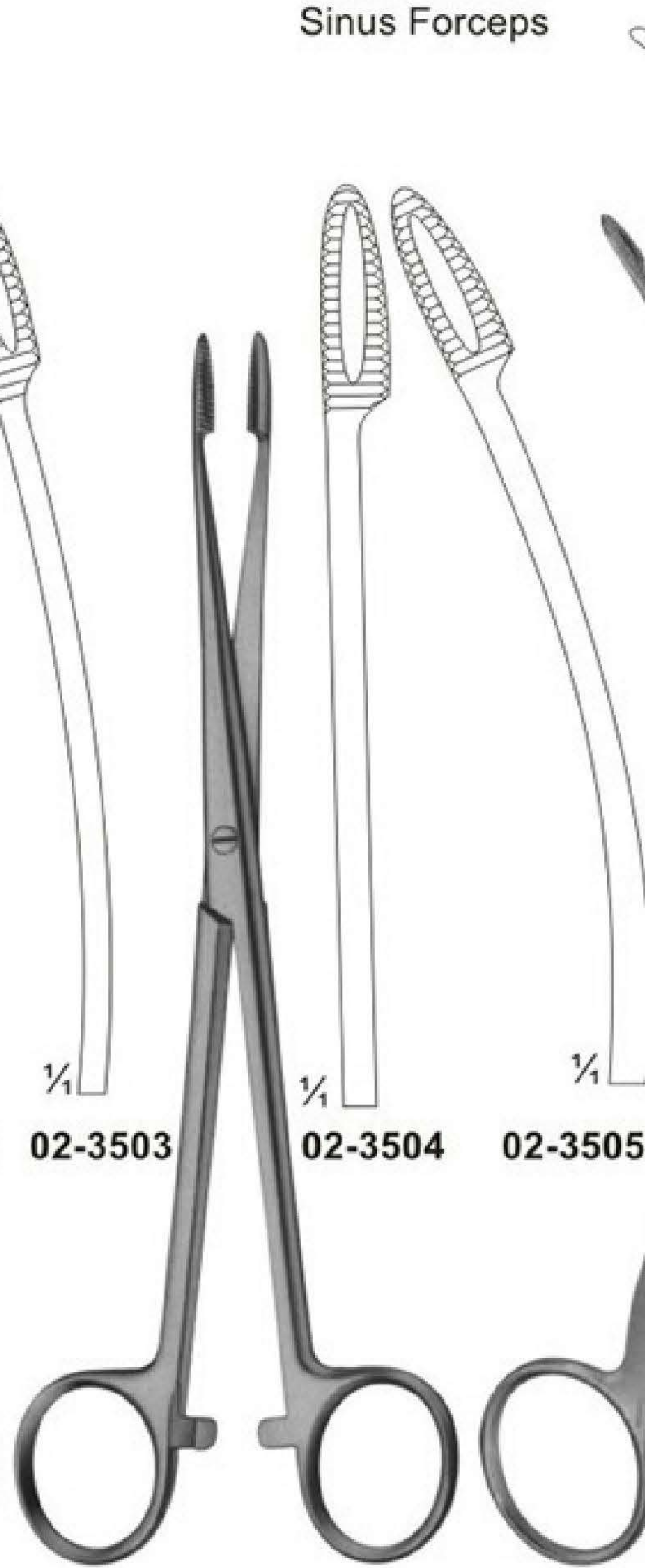

02-3504 - 02-3505
GROSS
With Ratchet
180 mm

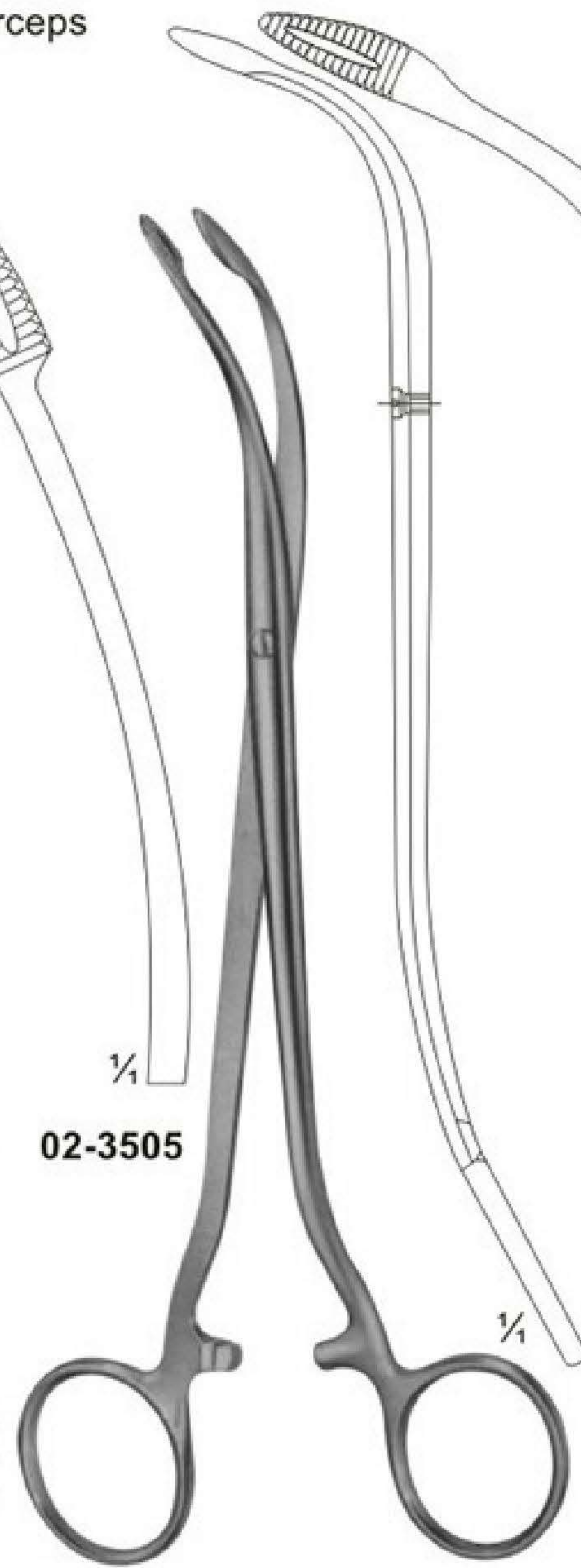

02-3506
DUPLAY
190 mm

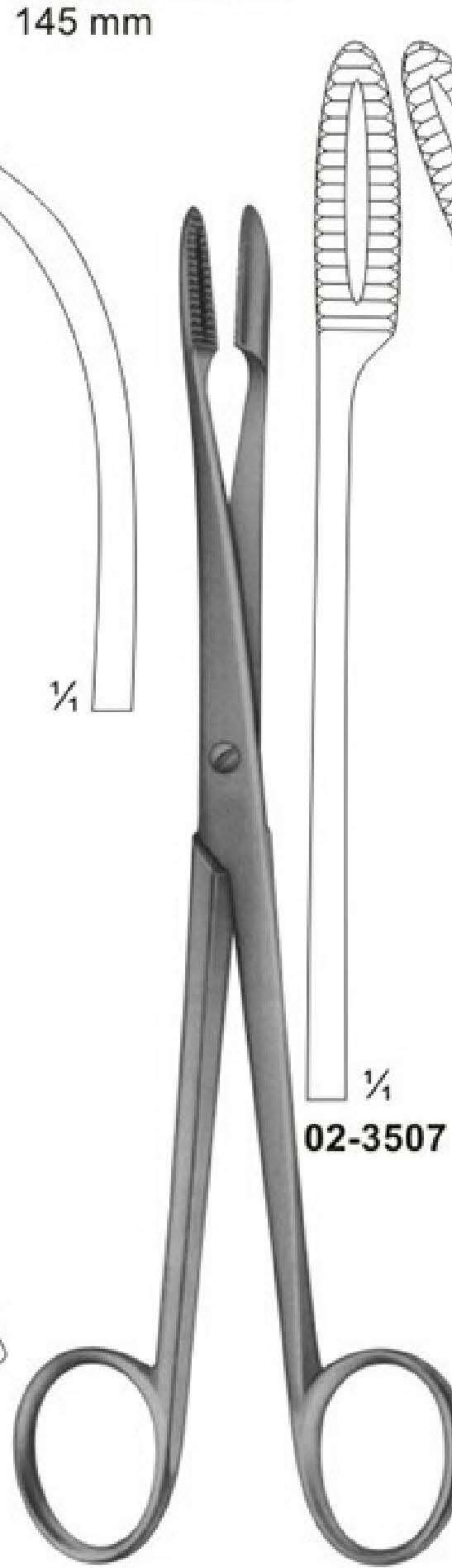

02-3507 - 02-3508
GROSS
Without Ratchet
200 mm

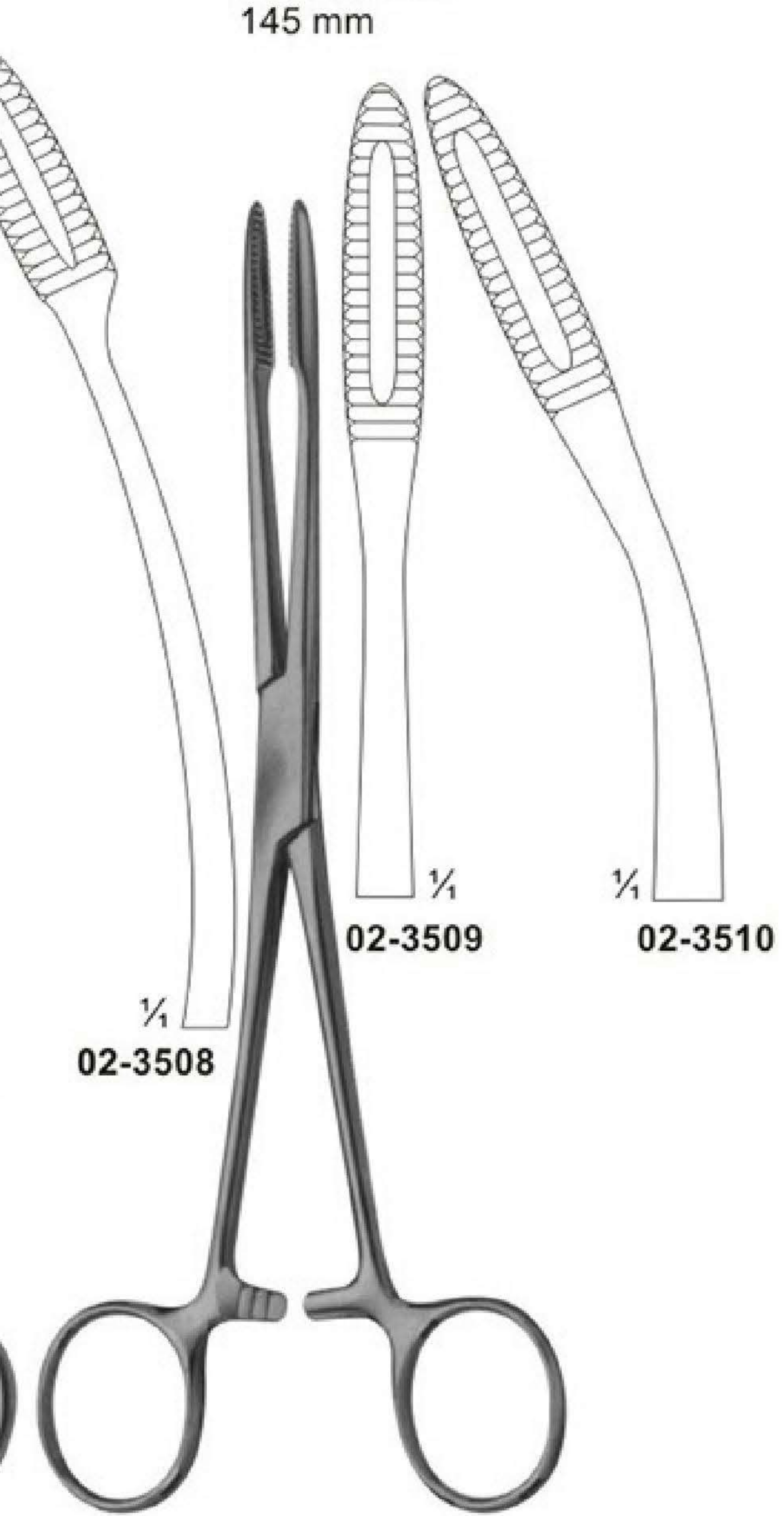

02-3509 - 02-3510
GROSS
With Ratchet
200 mm

Sponge and Dressing Forceps



02-3511 - 03-3512
ALM
220 mm

02-3513 - 02-3514
MAIER
Without Ratchet
265 mm

02-3515 - 02-3516
MAIER
With Ratchet
265 mm

Sponge and Dressing Forceps

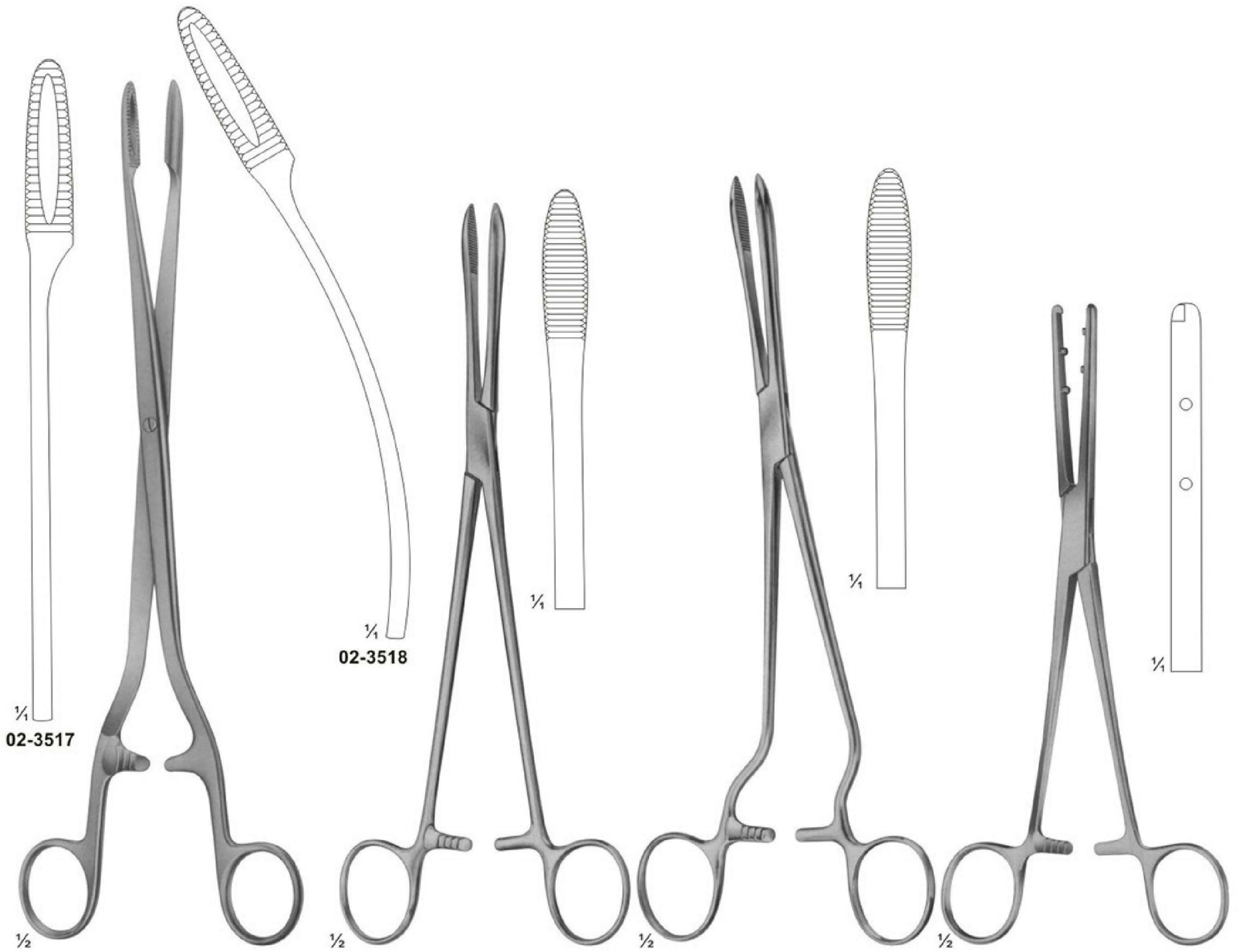

02-3517 - 02-3518
 SIMS-MAIER
 280 mm

02-3519
 COLLIN
 240 mm

02-3520
 CHERON
 Handles Laterally Angled
 240 mm

02-3521
 EMMET
 210 mm

Dressing, Sponge Holding, Organ and Tissue Grasping Forceps and Haemostatic Forceps

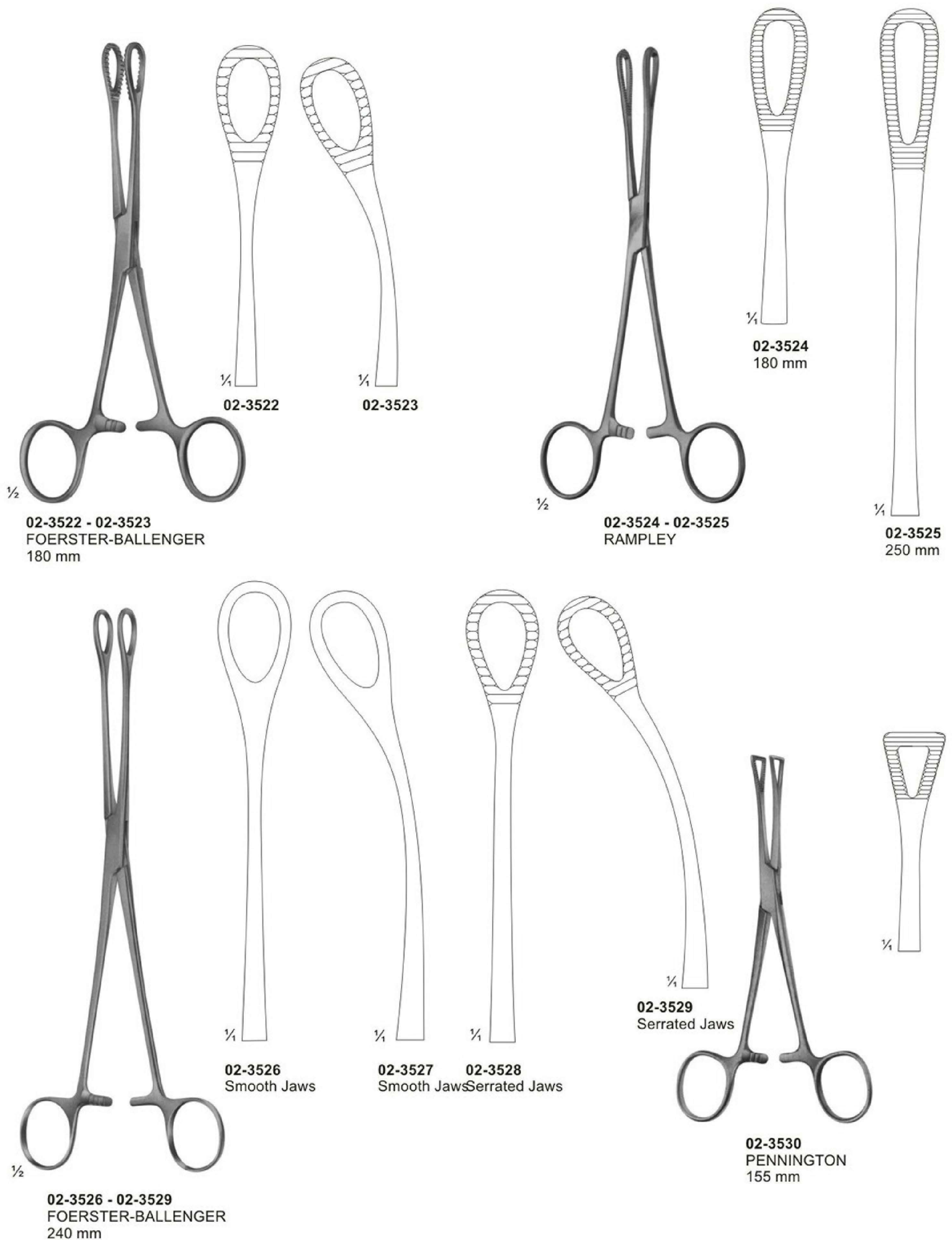

Dressing, Sponge holding, Organ and Tissue Grasping Forceps

ATRAUMATA

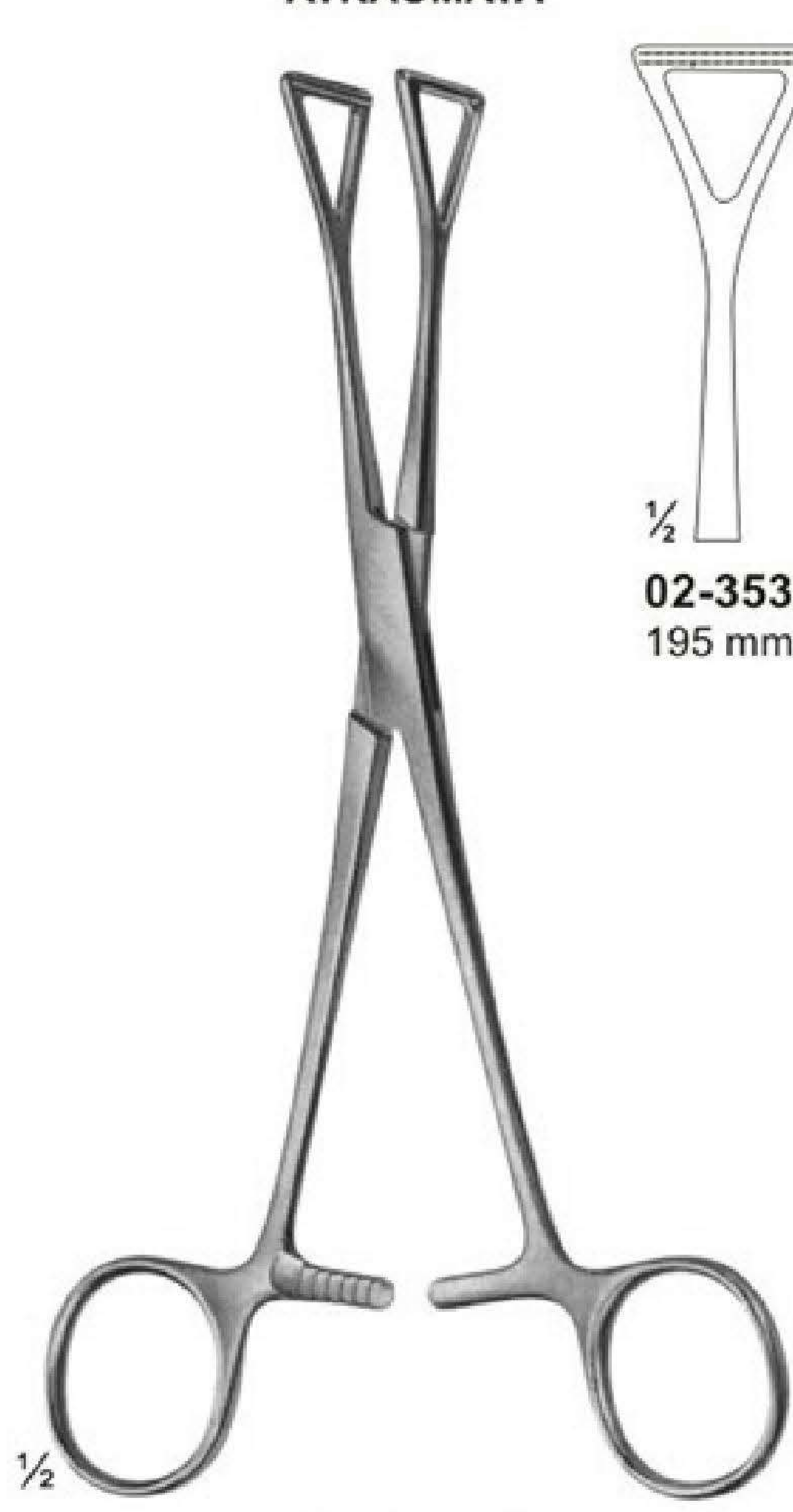

02-3531 - 02-3532
COLLIN



02-3531
195 mm



02-3532
230 mm

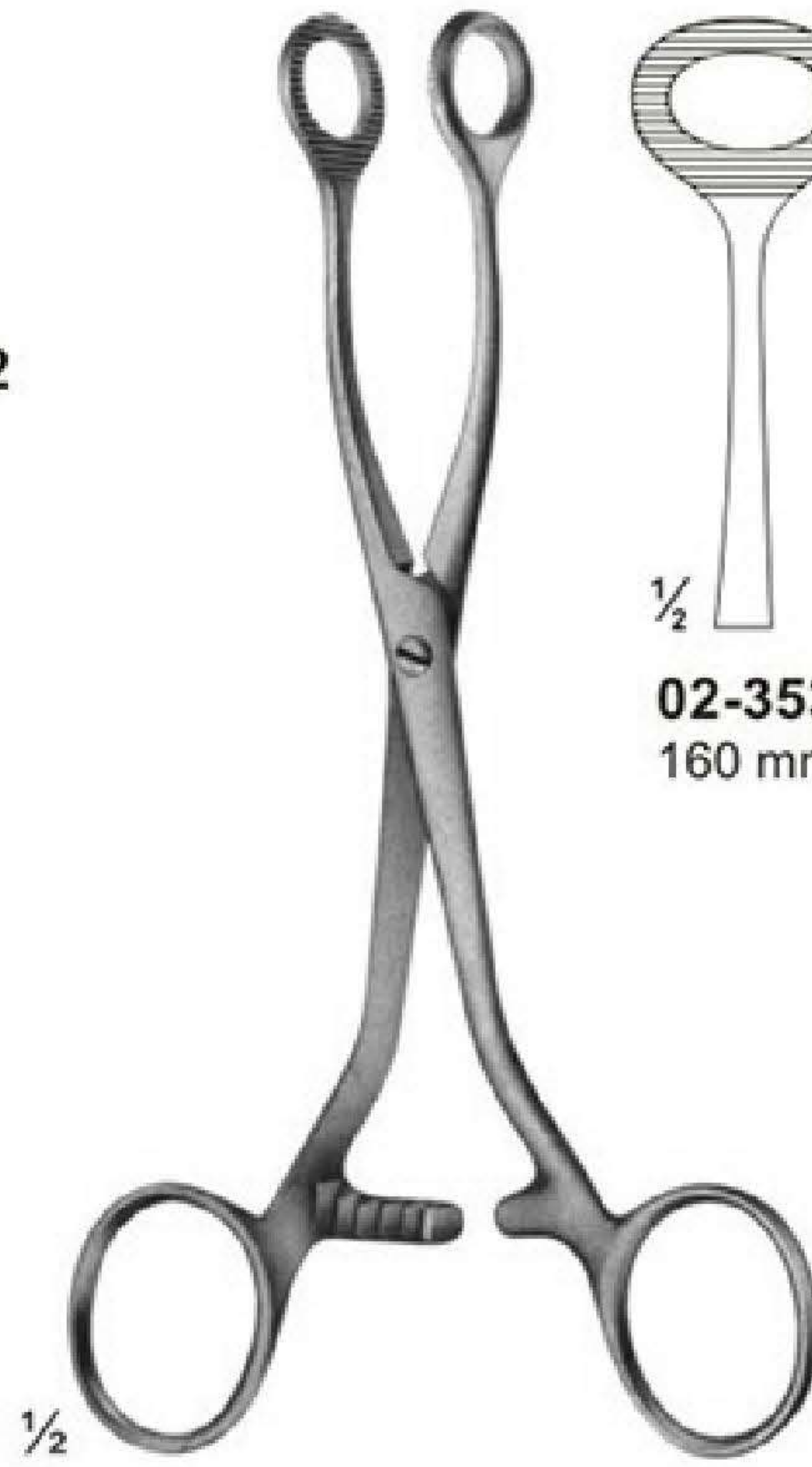

02-3533 - 02-3535
COLLIN



02-3533
160 mm



02-3534
160 mm



02-3535
170 mm

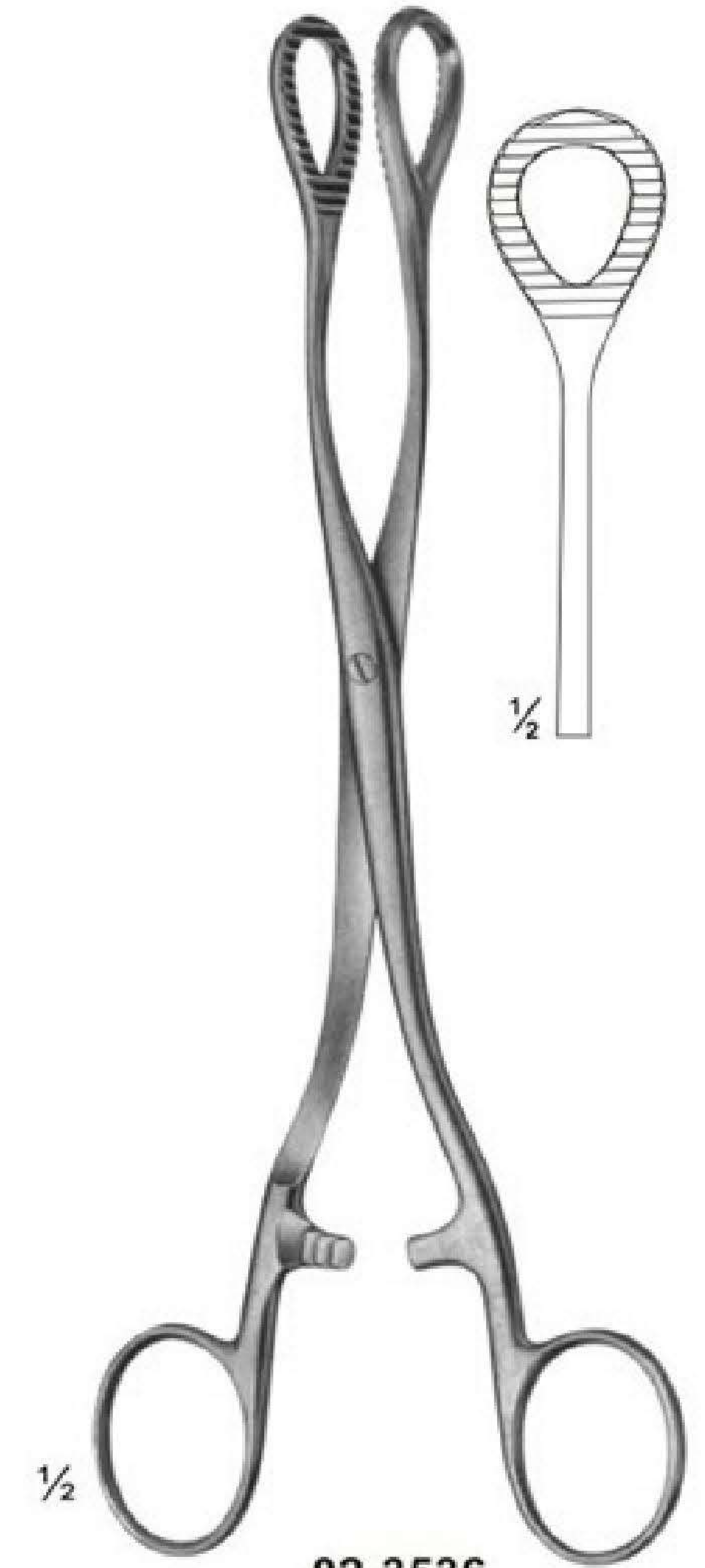

02-3536
HEYWOOD-
SMITH
200 mm

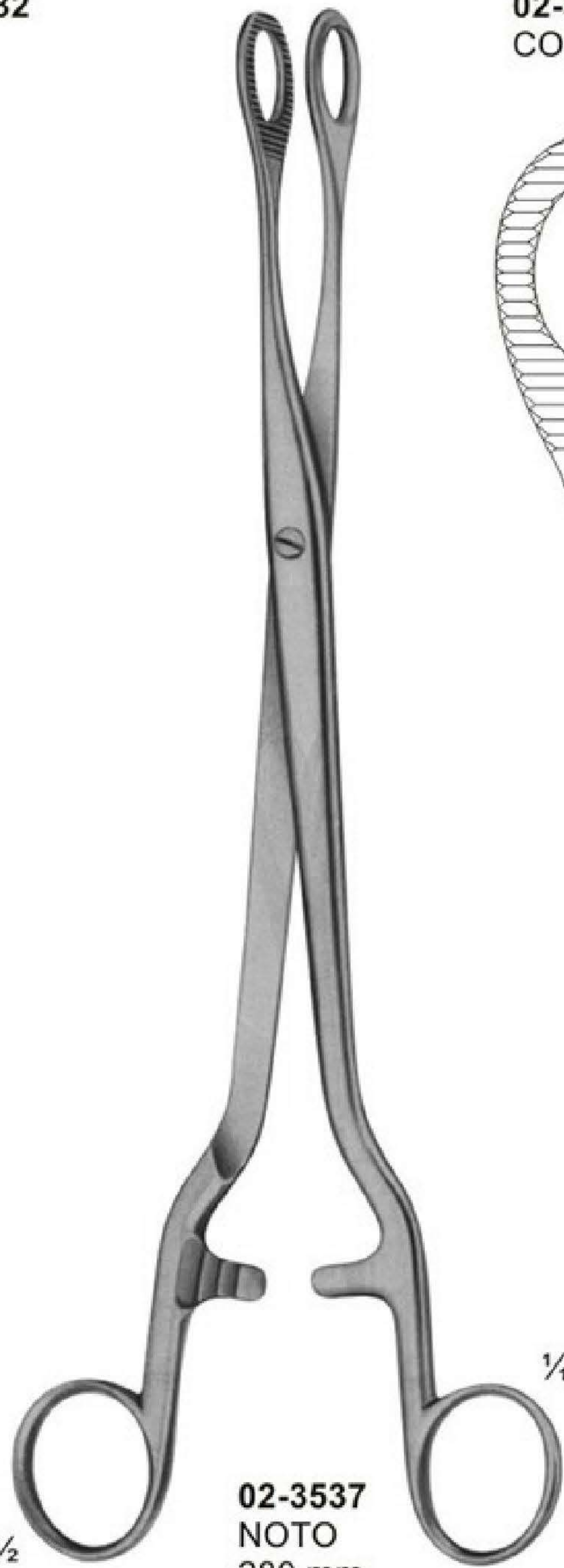

02-3537
NOTO
280 mm

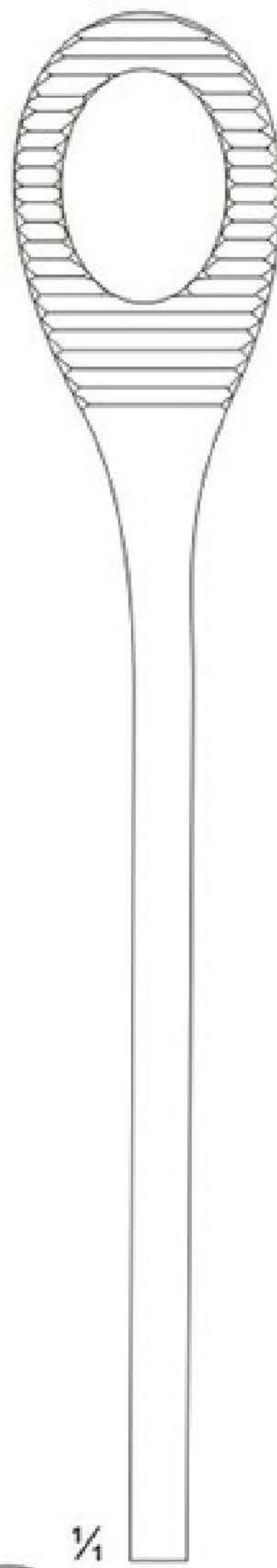

1/4

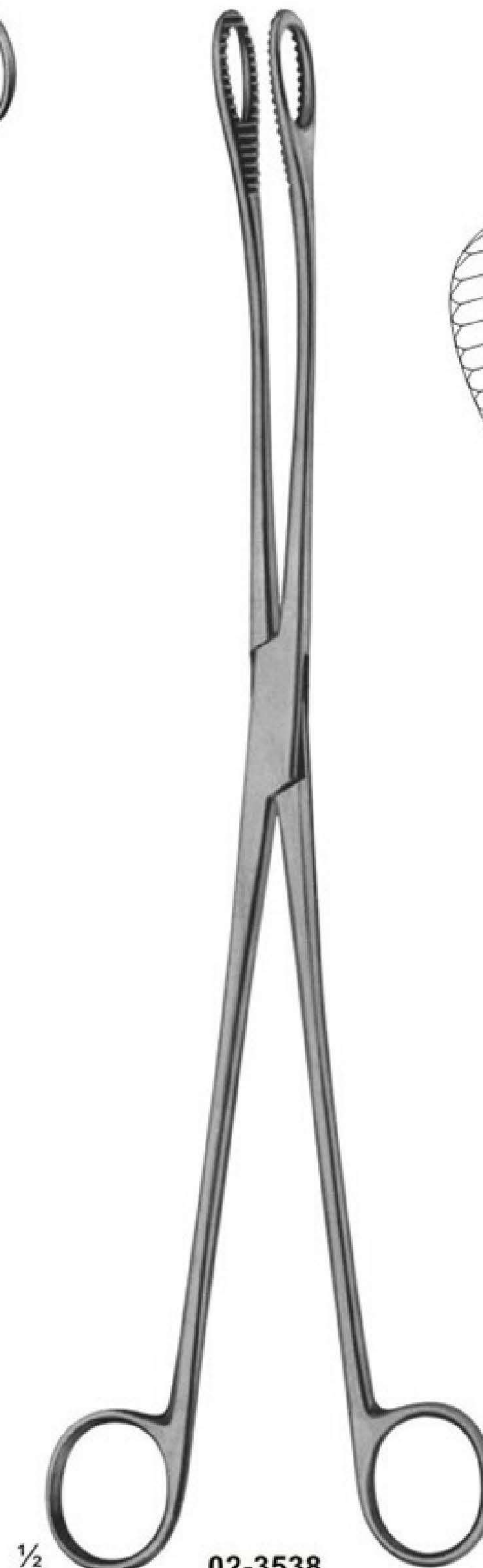

02-3538
KELLY
320 mm

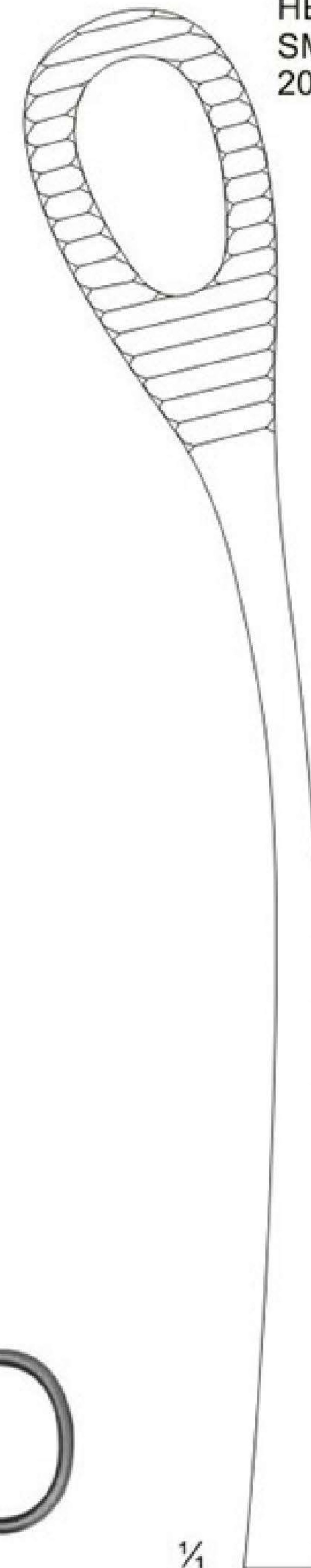

1/4

Tendon Seizing Forceps

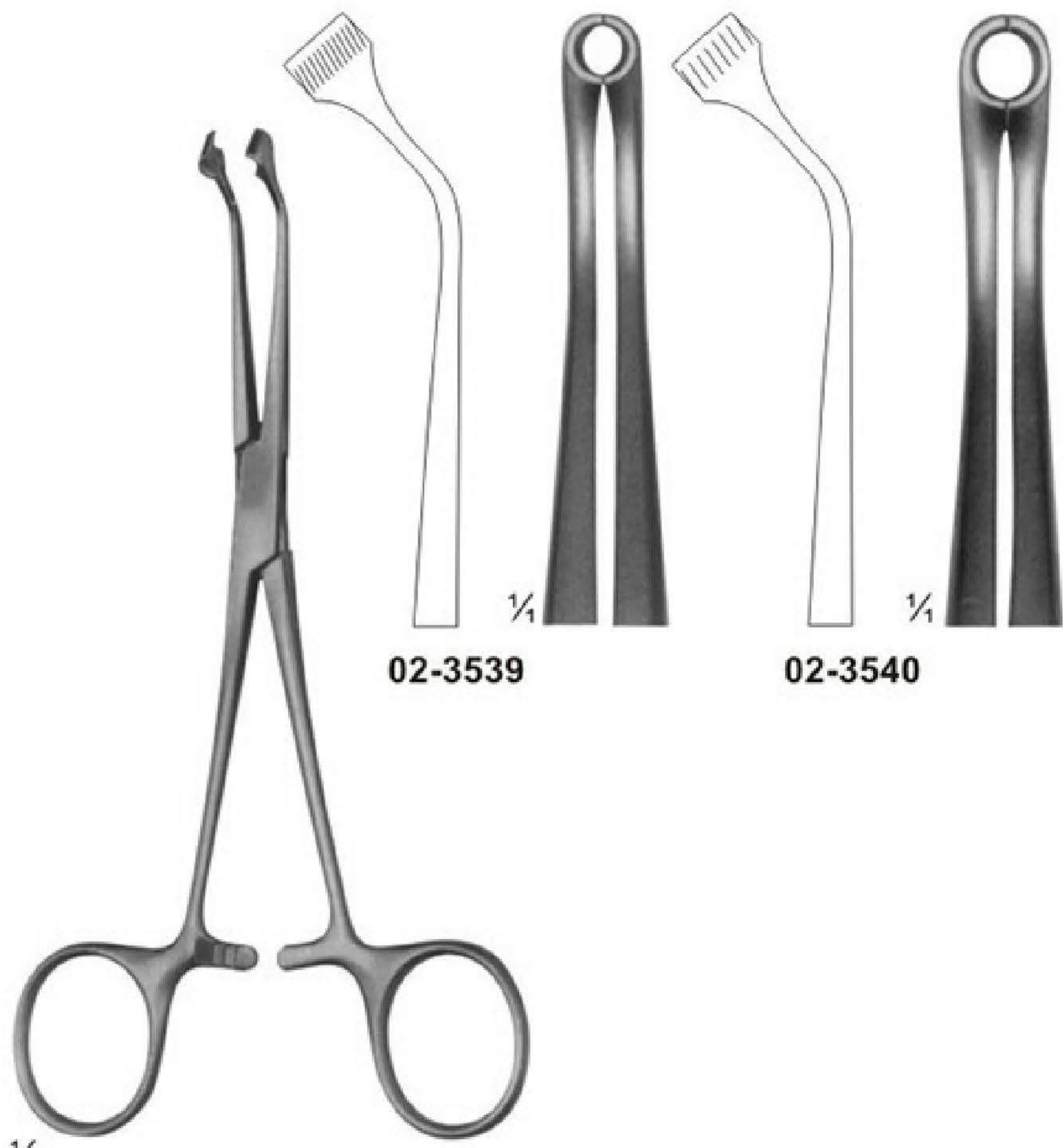

02-3539

02-3540

1/2
02-3539 - 02-3540
HERZ
155 mm



02-3541

1/2
02-3541
JACKSON
4 x 5 teeth
150 mm

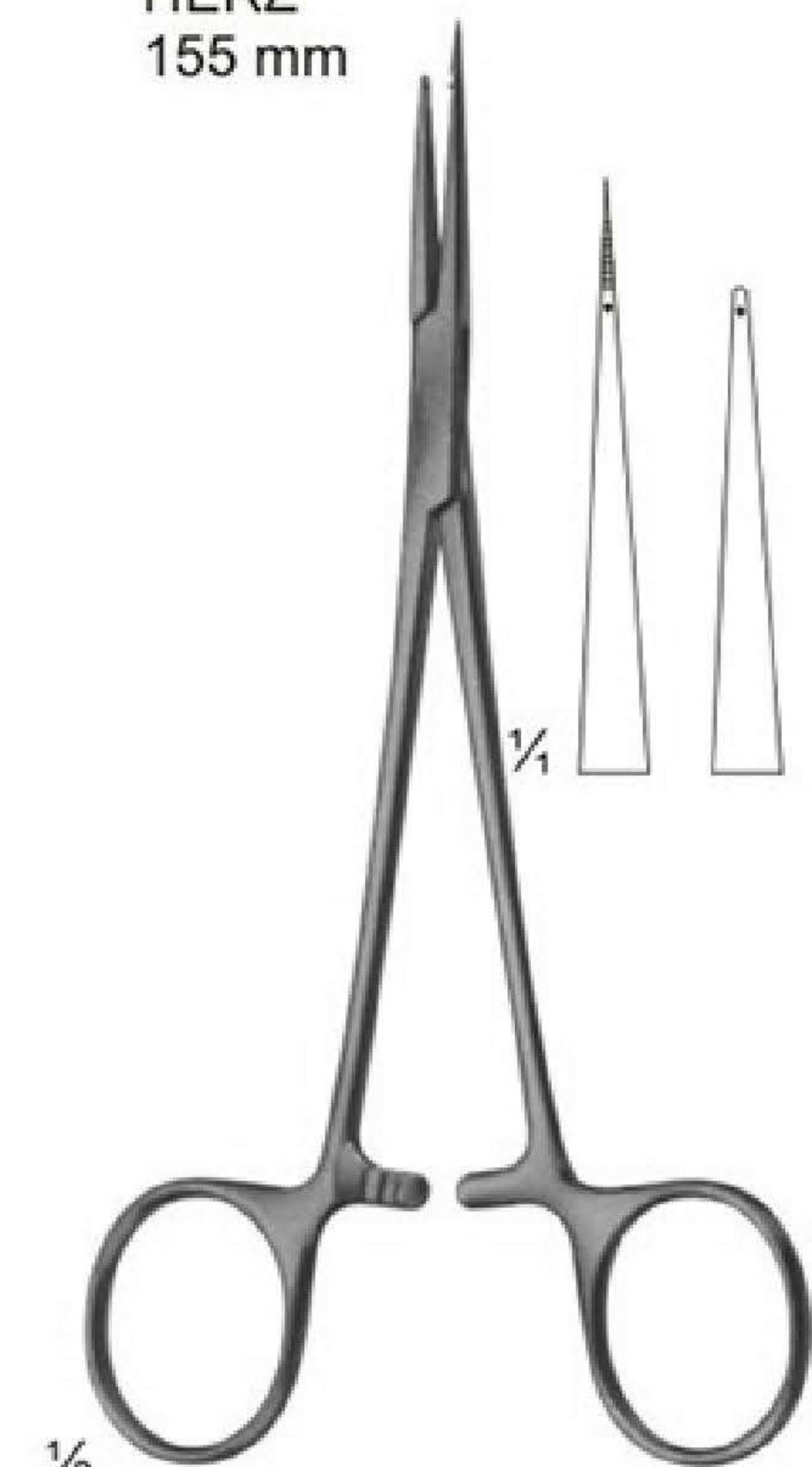

1/2
02-3542
Tendon interlacing
forceps
150 mm



1/2
02-3543
Tendon interlacing
forceps
150 mm



1/2
02-3544
Tendon seizing
forceps
120 mm

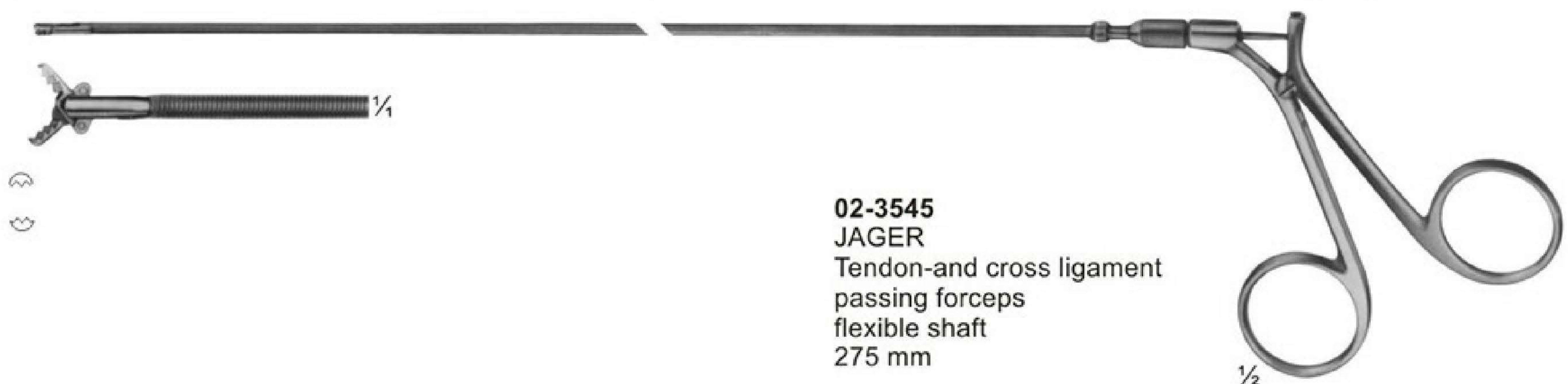

1/2
02-3545
JAGER
Tendon-and cross ligament
passing forceps
flexible shaft
275 mm

Artery Traction - and Tissue Grasping Forceps

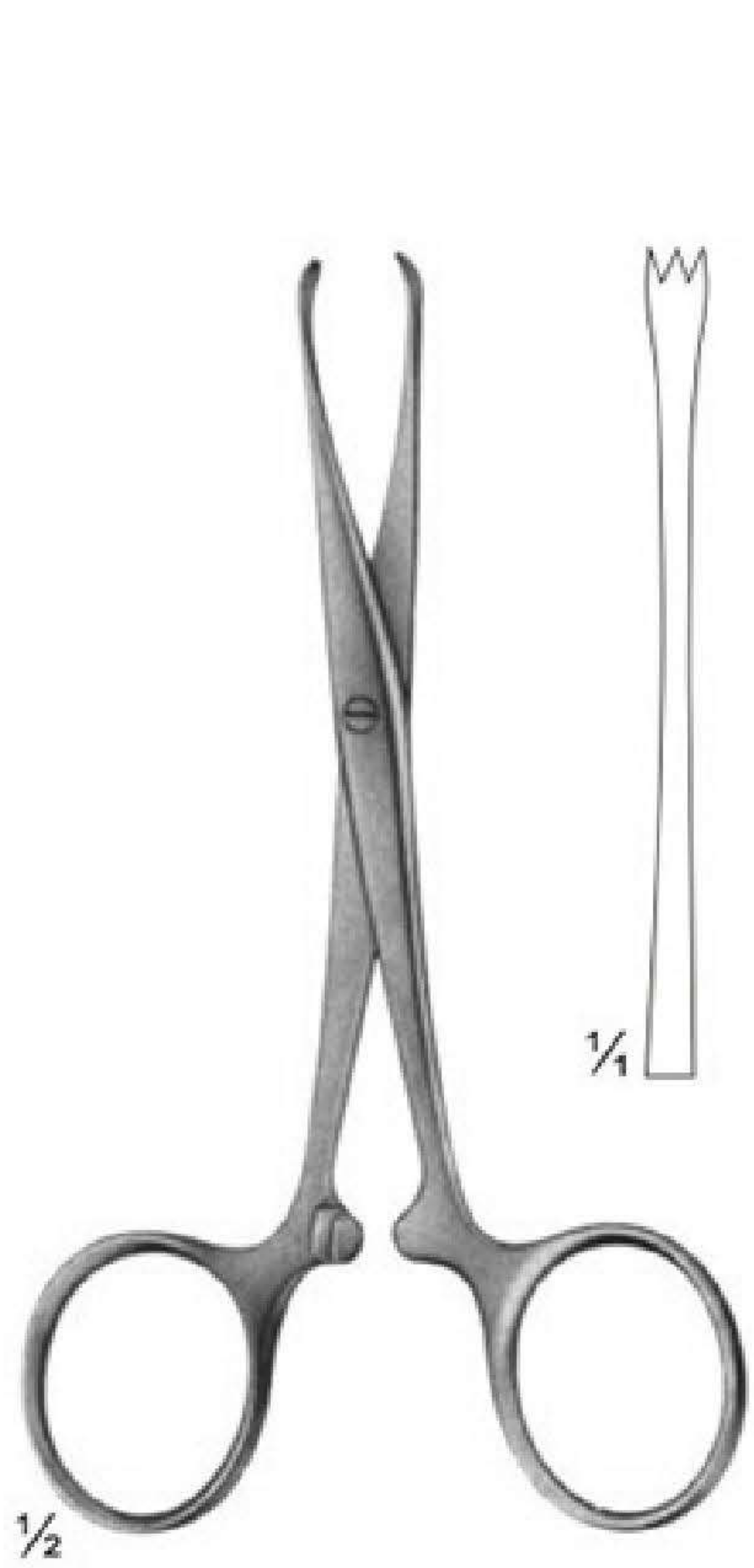

02-3546
 CHAPUT
 2 x 3 teeth sharp
 125 mm

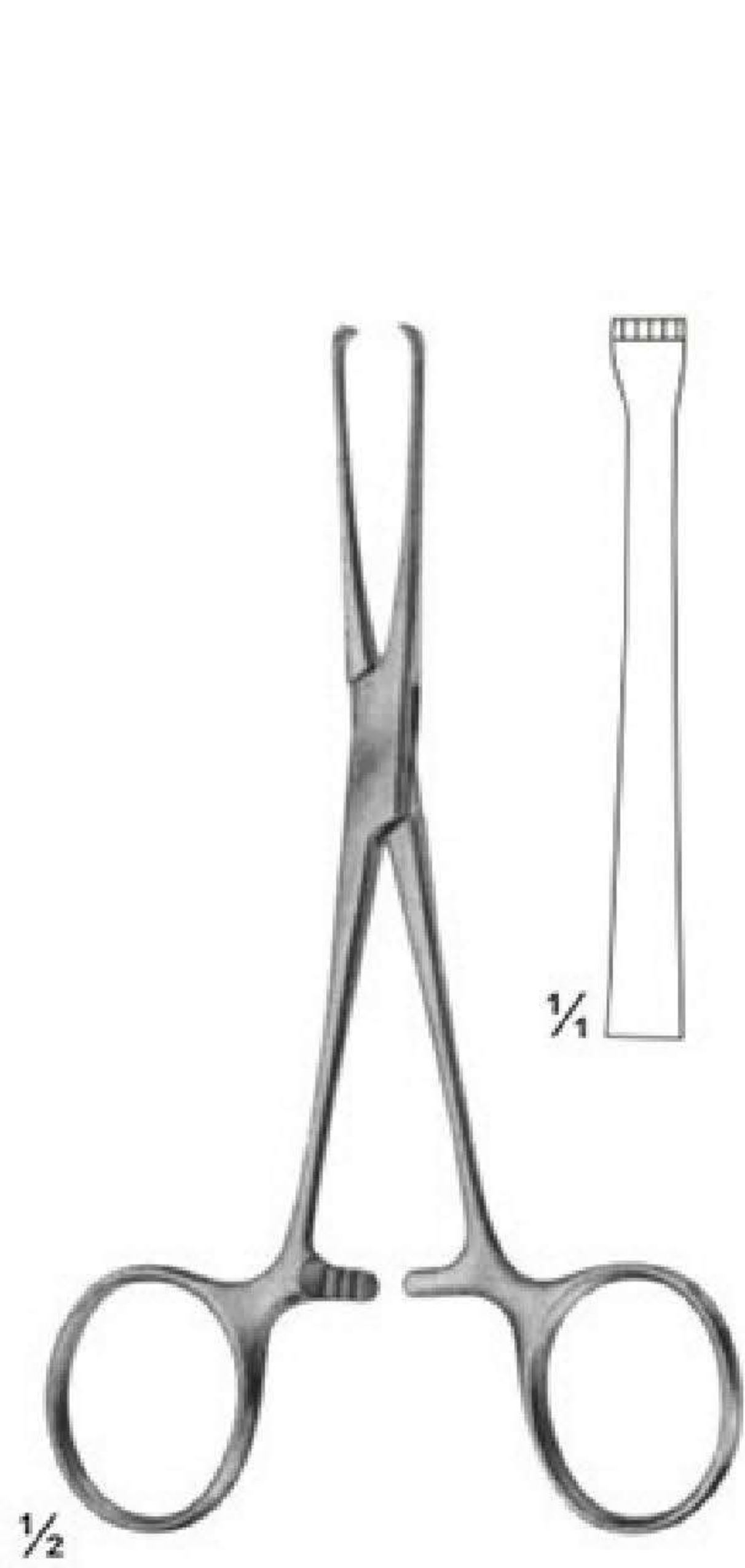

02-3547
 BABY-ALLIS
 4 x 5 teeth
 130 mm

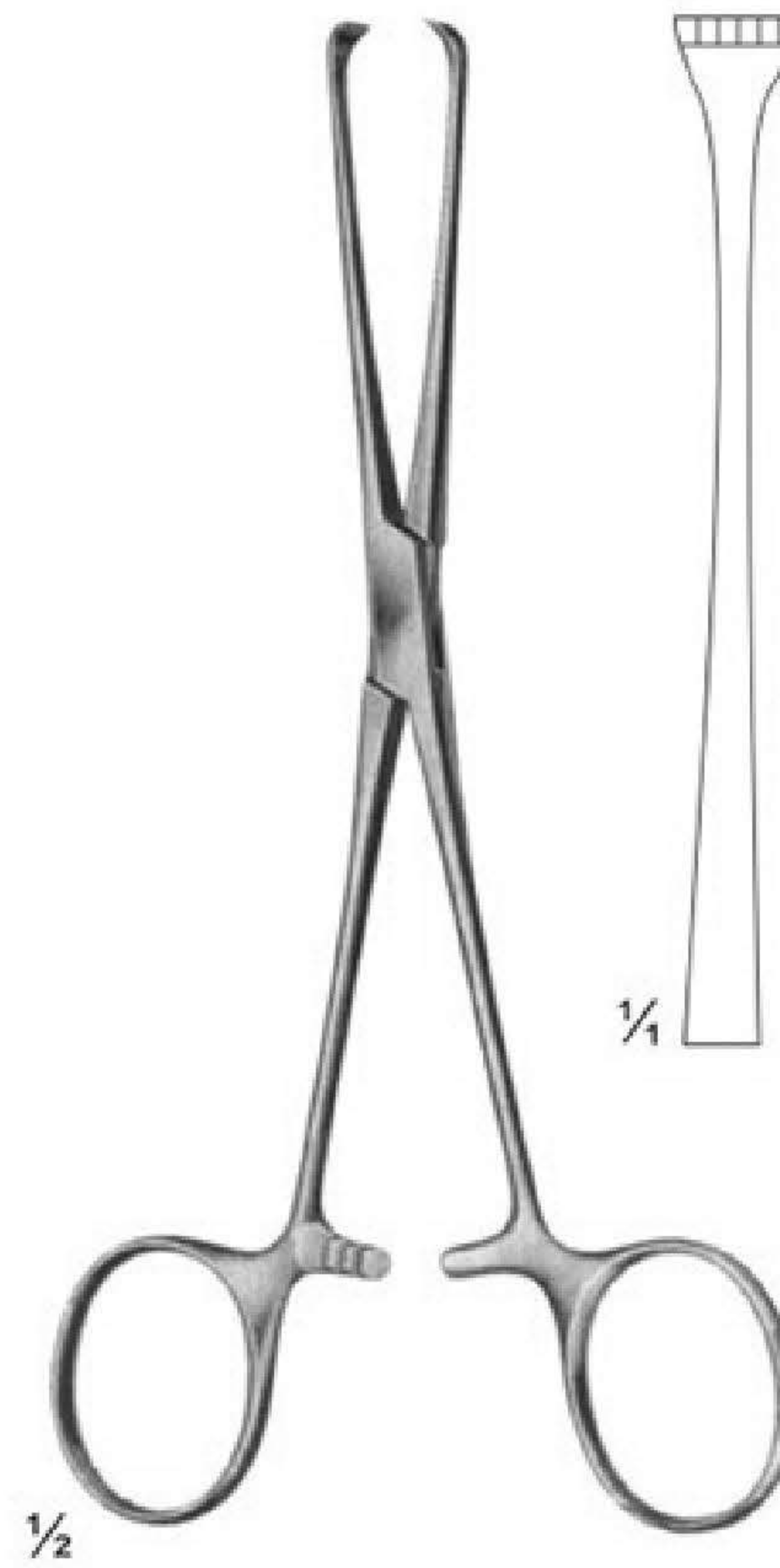

02-3548
 BOYS-ALLIS
 5 x 6 teeth sharp
 155 mm

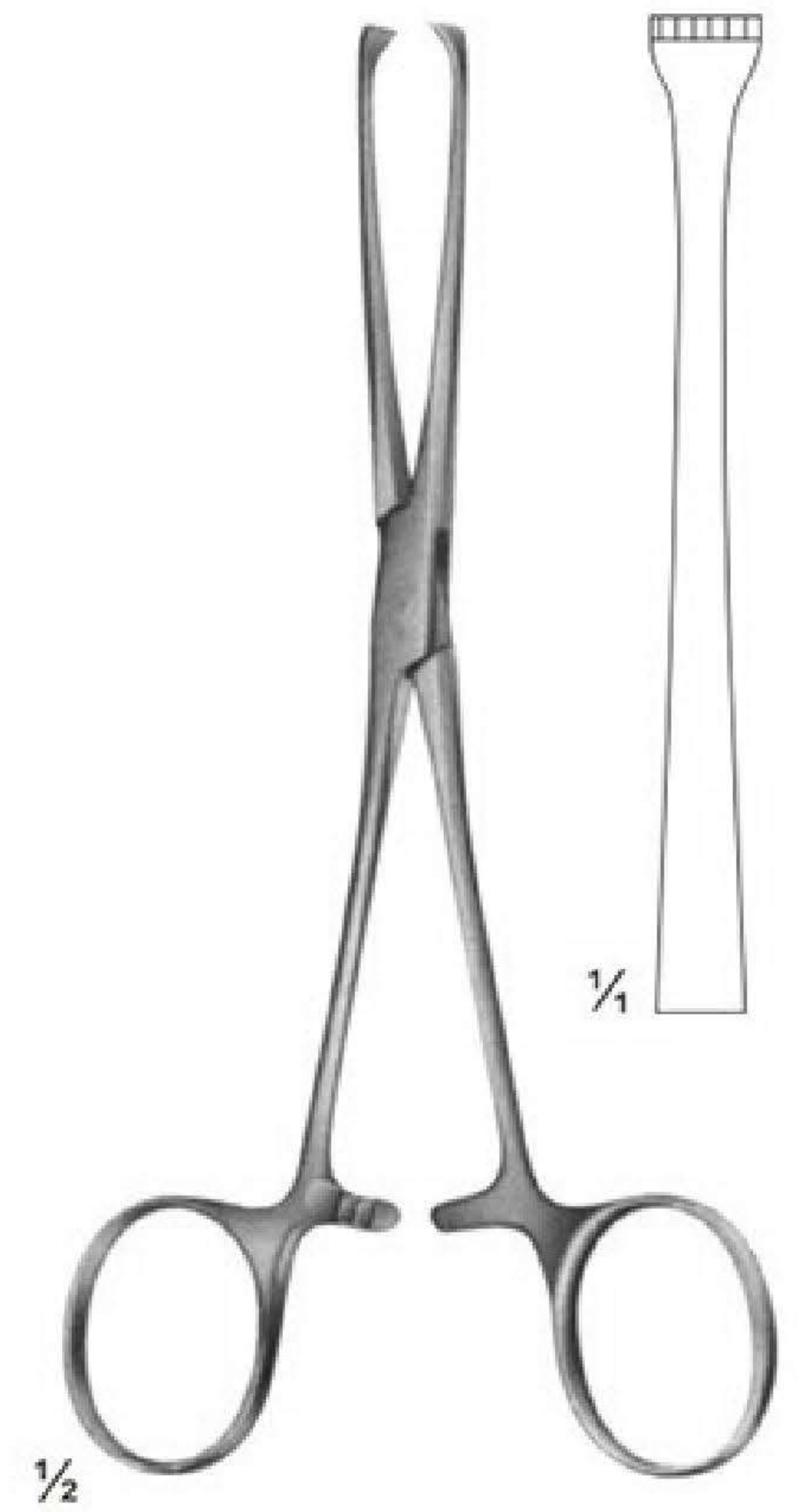

02-3549
 ALLIS
 5 x 6 teeth blunt
 155 mm



02-3550
 LAHEY
 155 mm

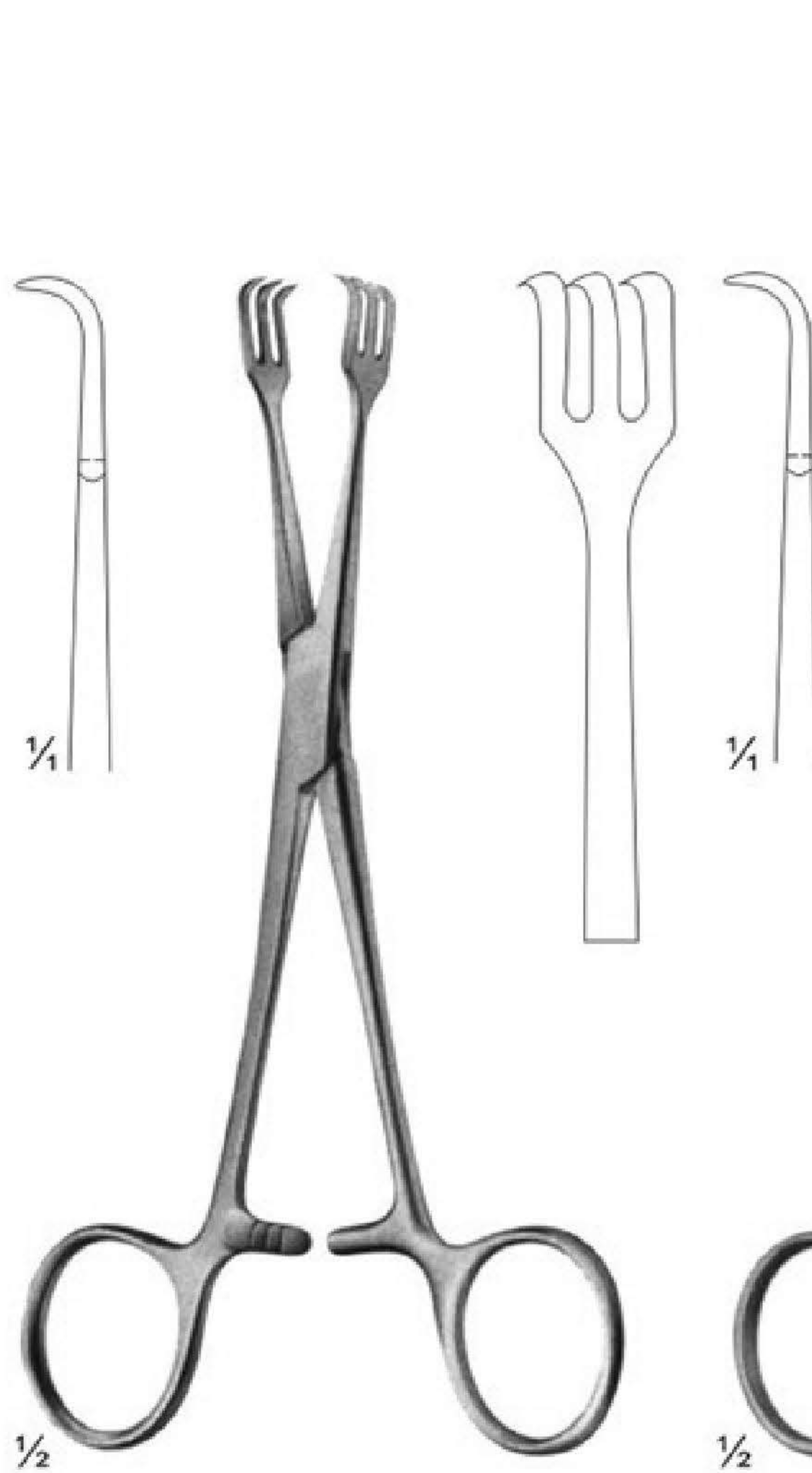

02-3551
 LAHEY
 155 mm

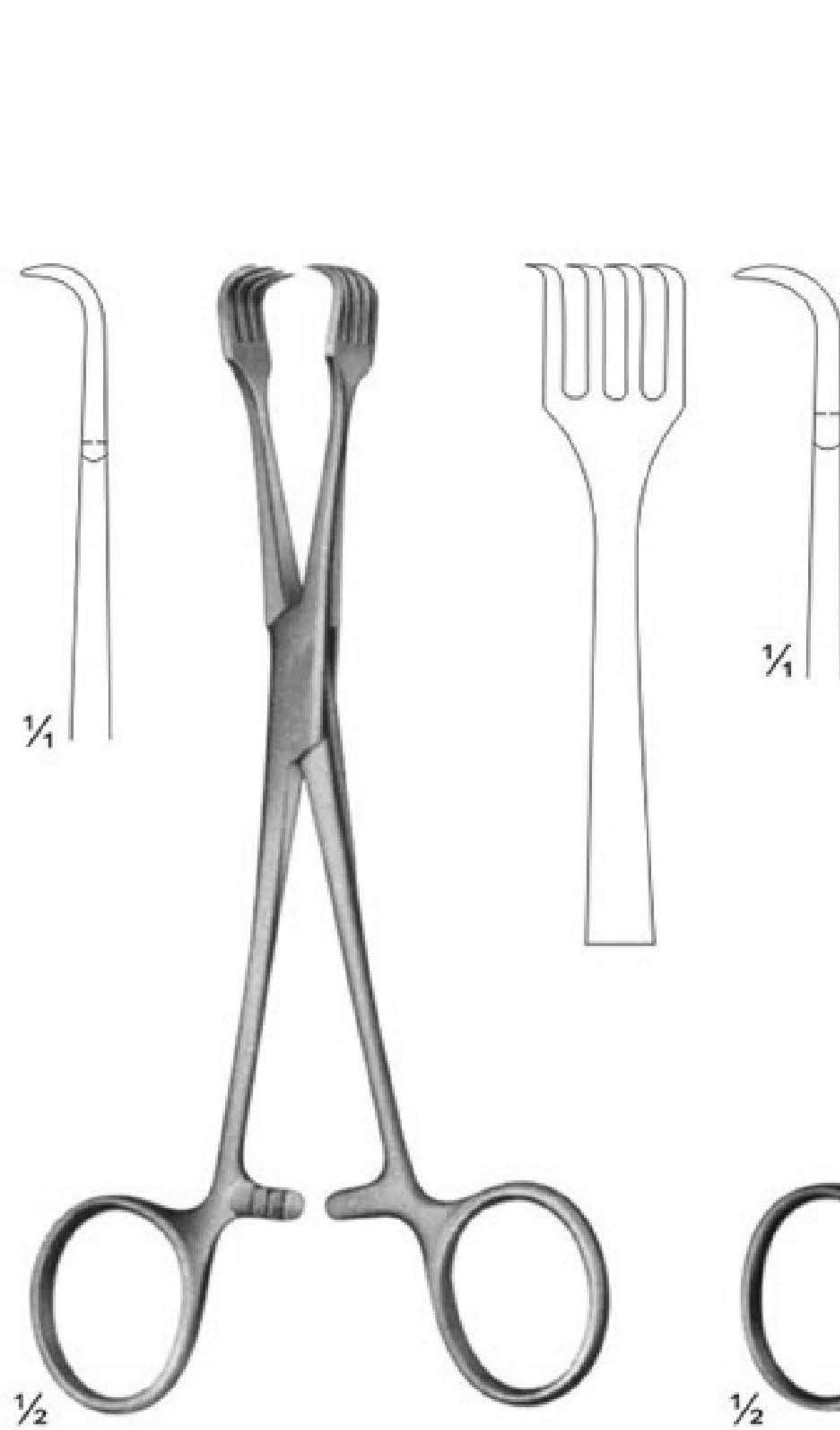

02-3552
 BRAUN
 155 mm

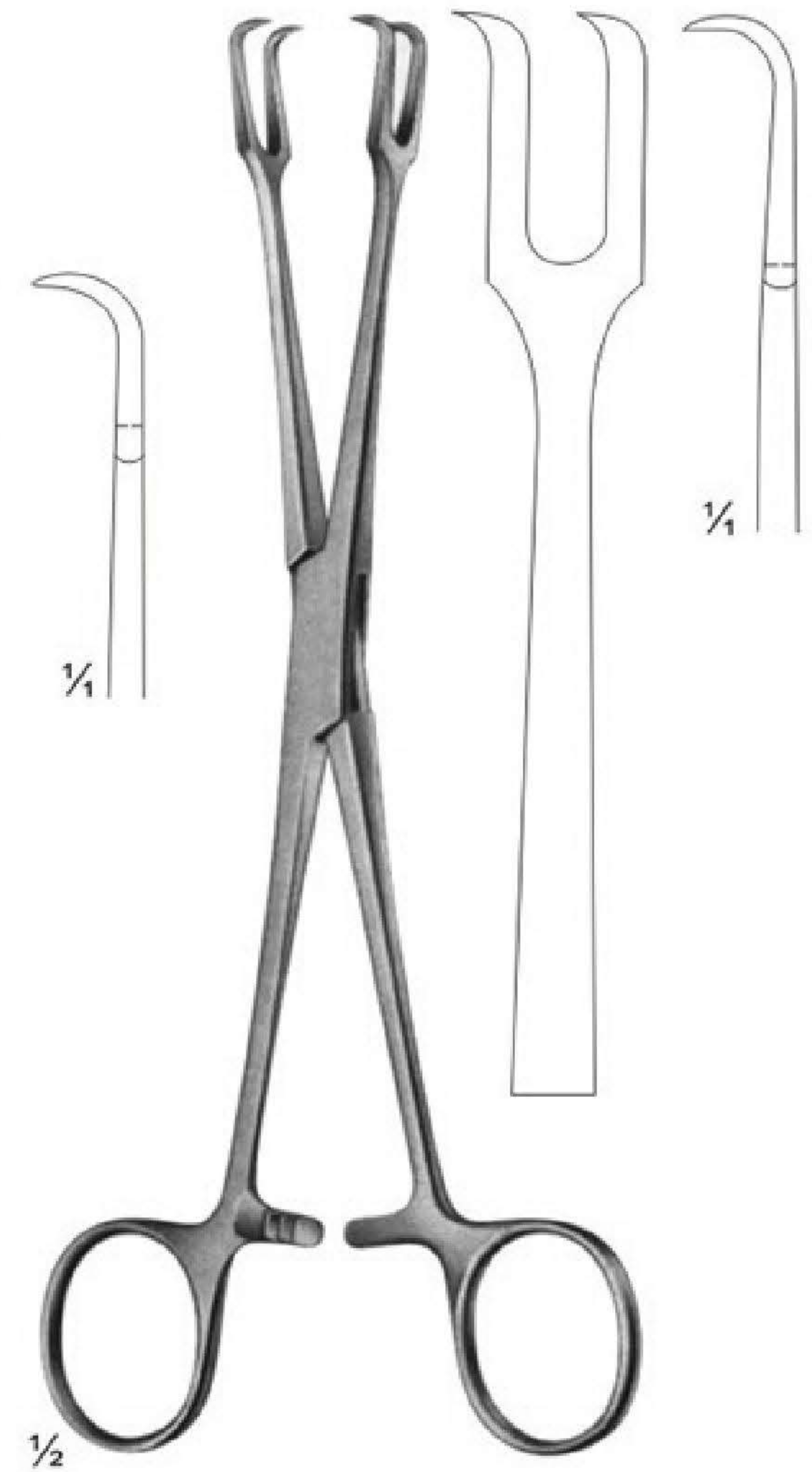

02-3553
 MUSEUX
 200 mm

Organ - and Tissue Grasping Forceps

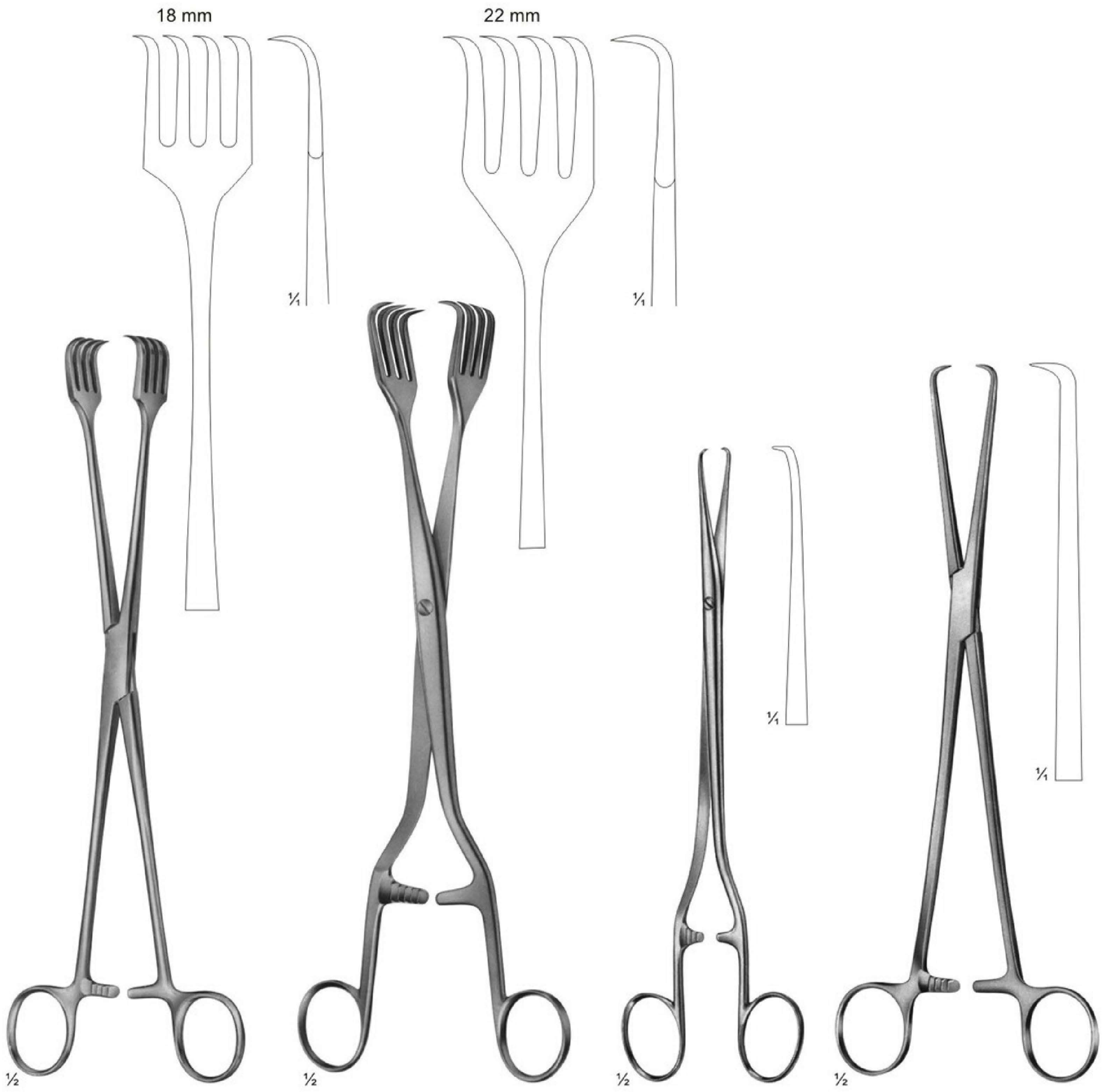

02-3554
 ALM
 260 mm

02-3555
 PRATT
 270 mm

02-3556
 TIEMANN
 Bullet forceps
 220 mm

02-3557
 SCHROEDER
 250 mm

Towel Clamps

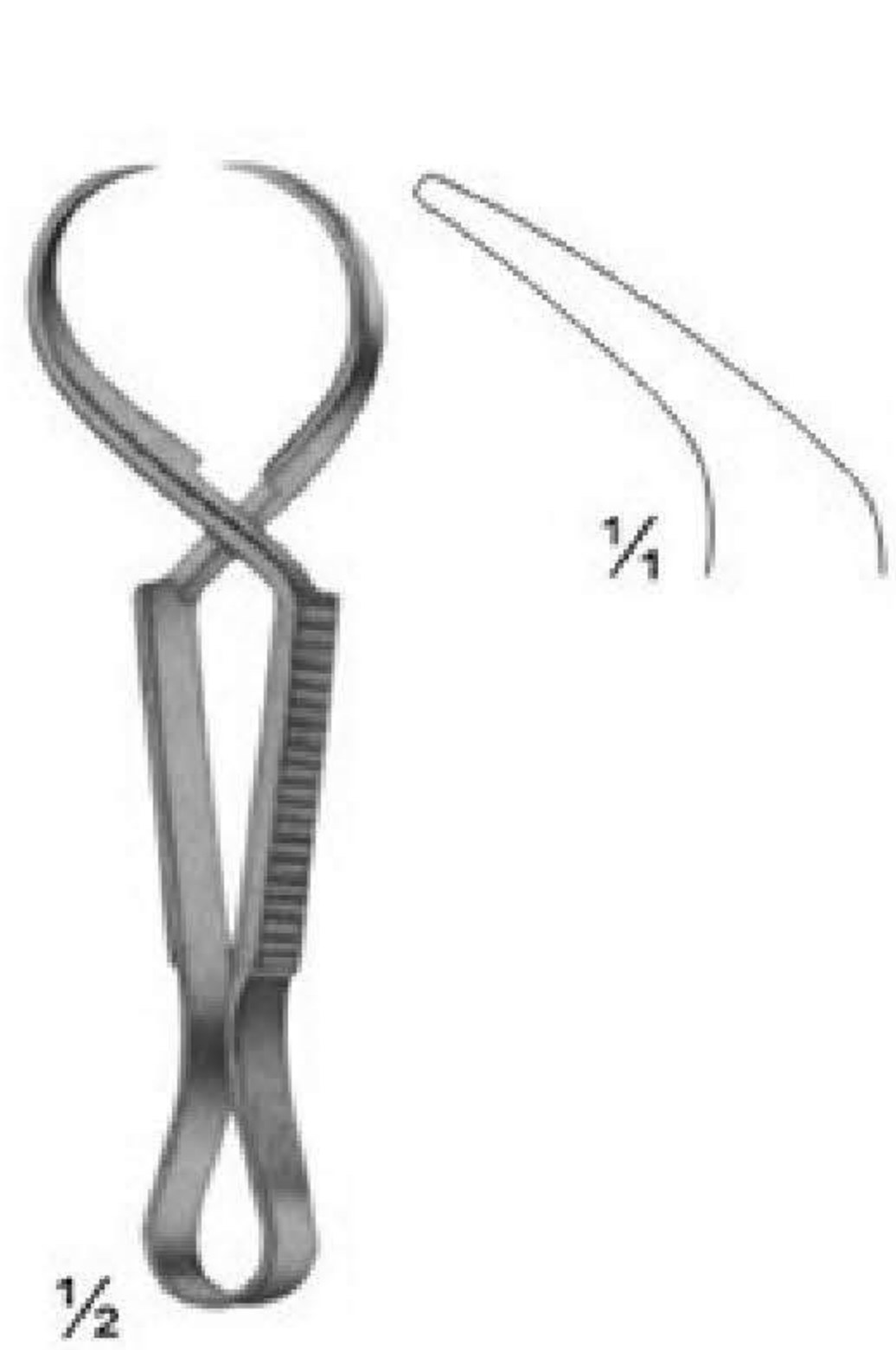

02-3558
JONES
85 mm

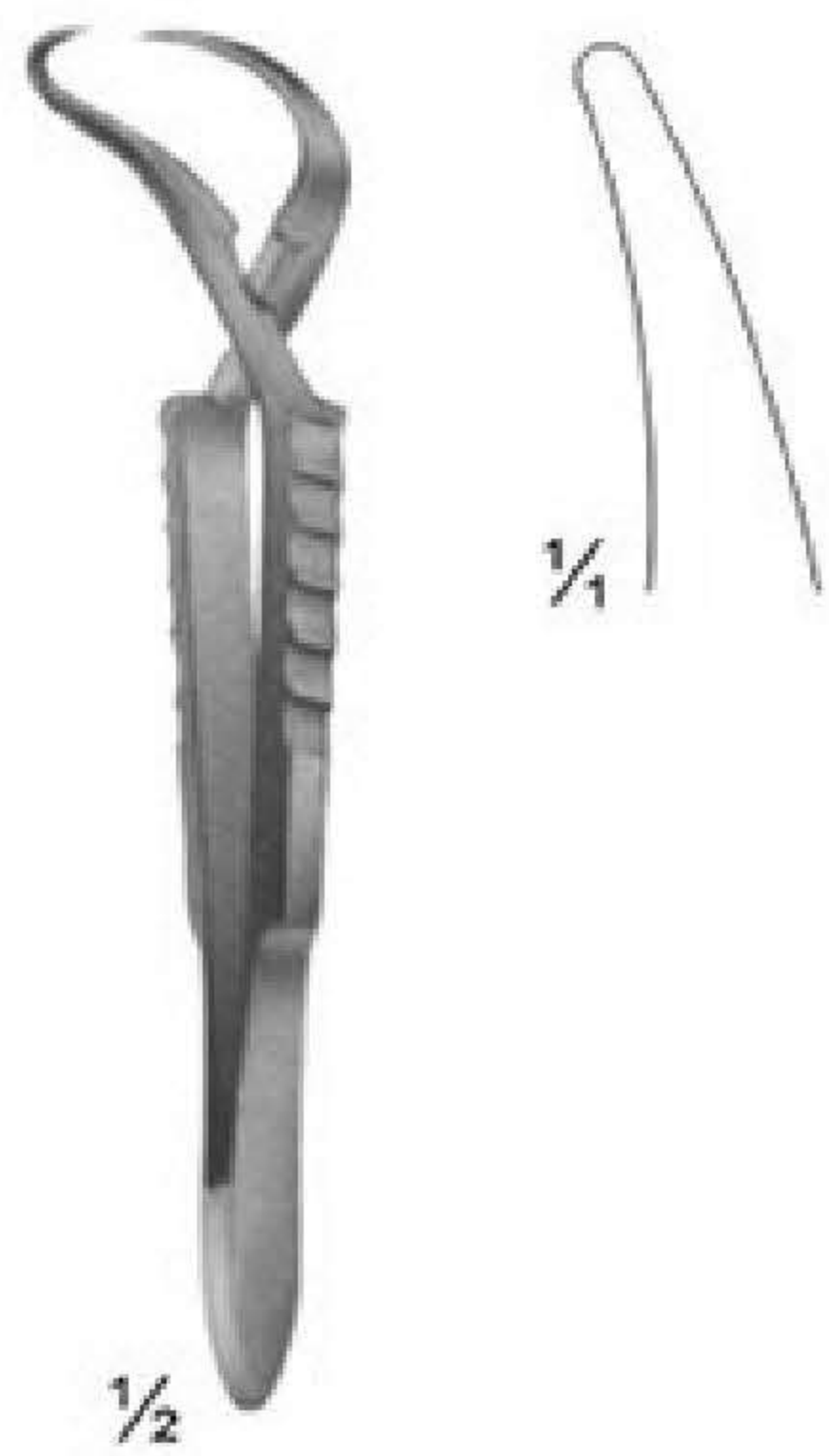

02-3559
ENGL.MOD.
85 mm

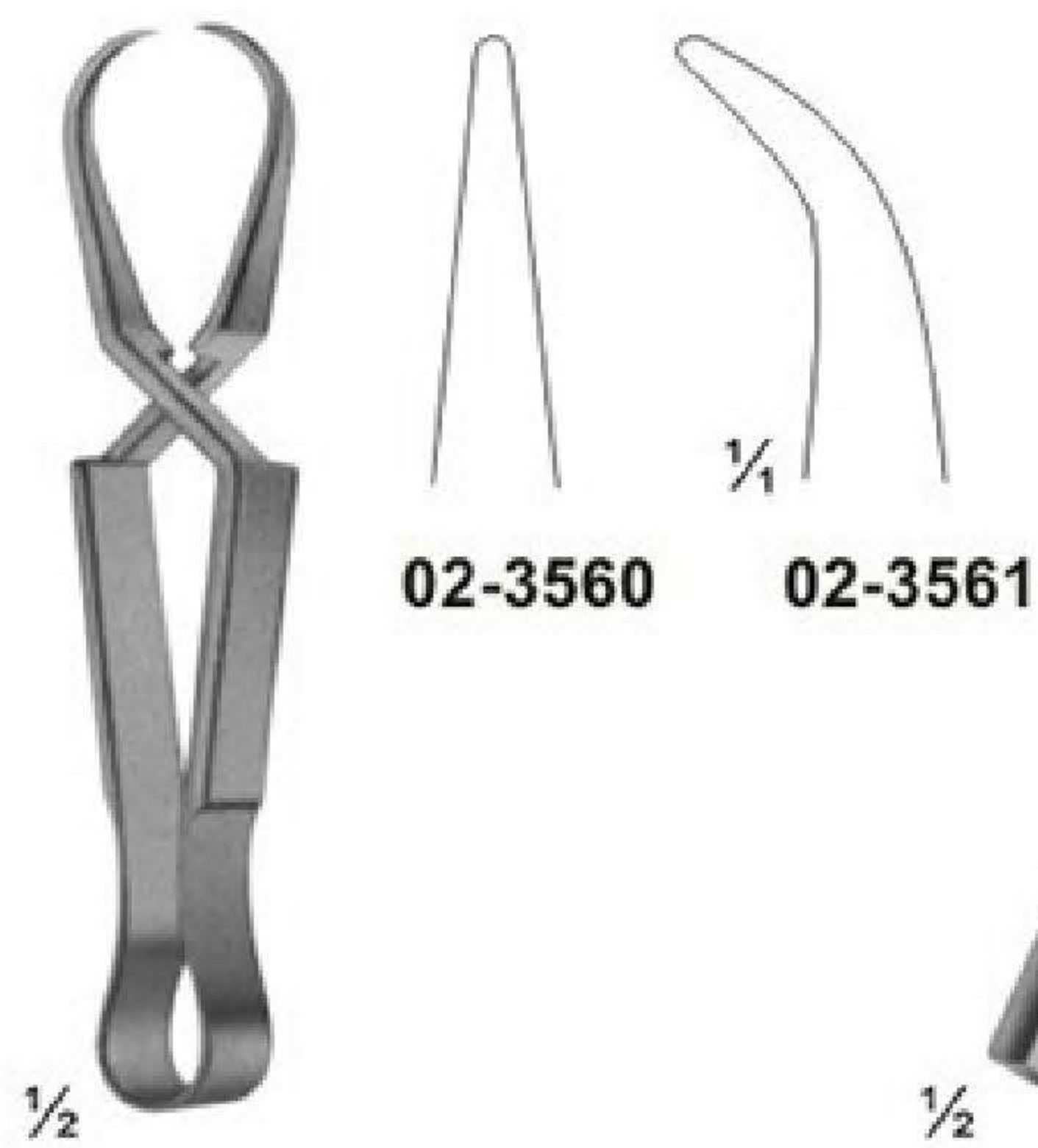

02-3560 - 02-3561
SCHAEDEL
85 mm

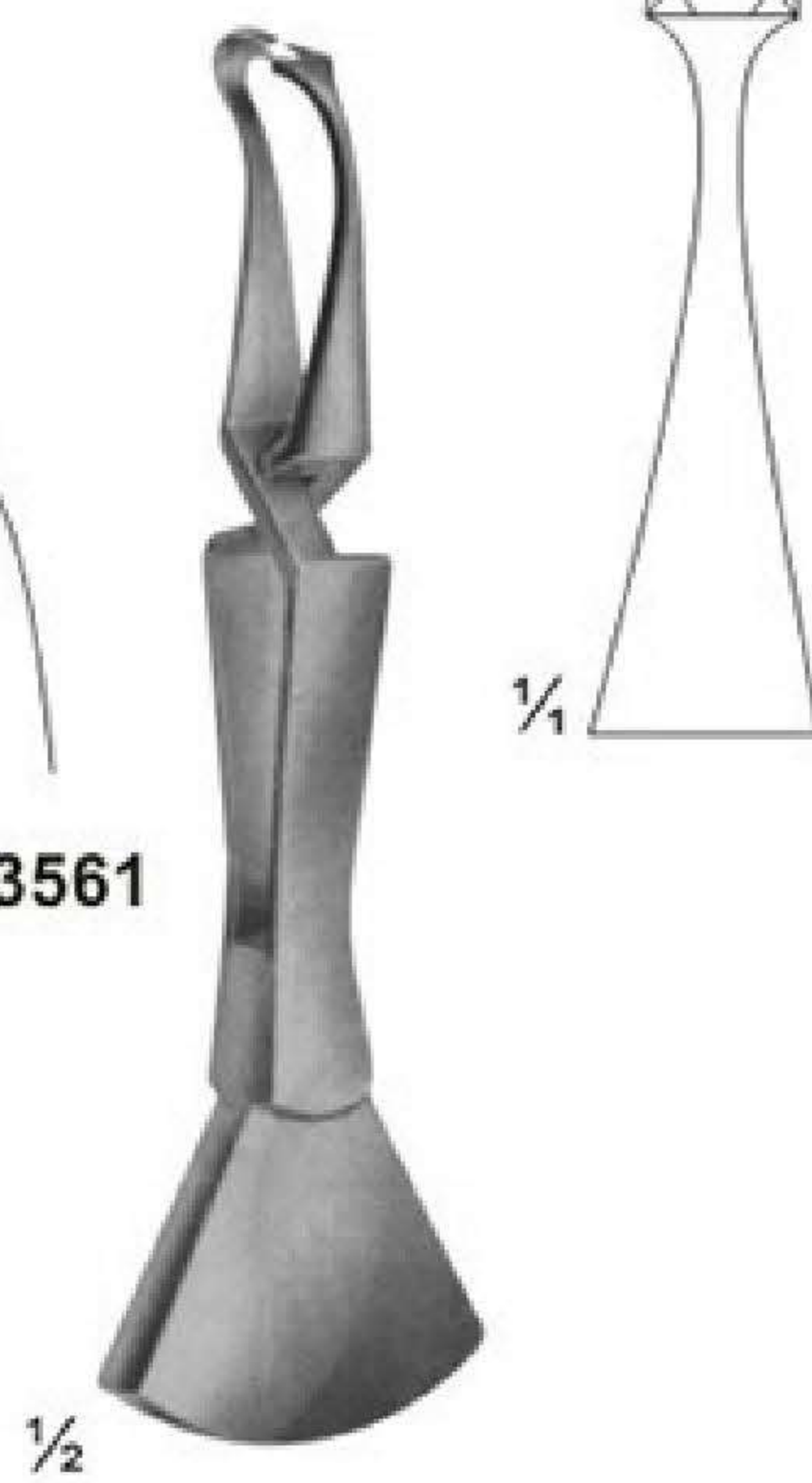

02-3562
DOYEN
110 mm



02-3563
DOYEN
180 mm

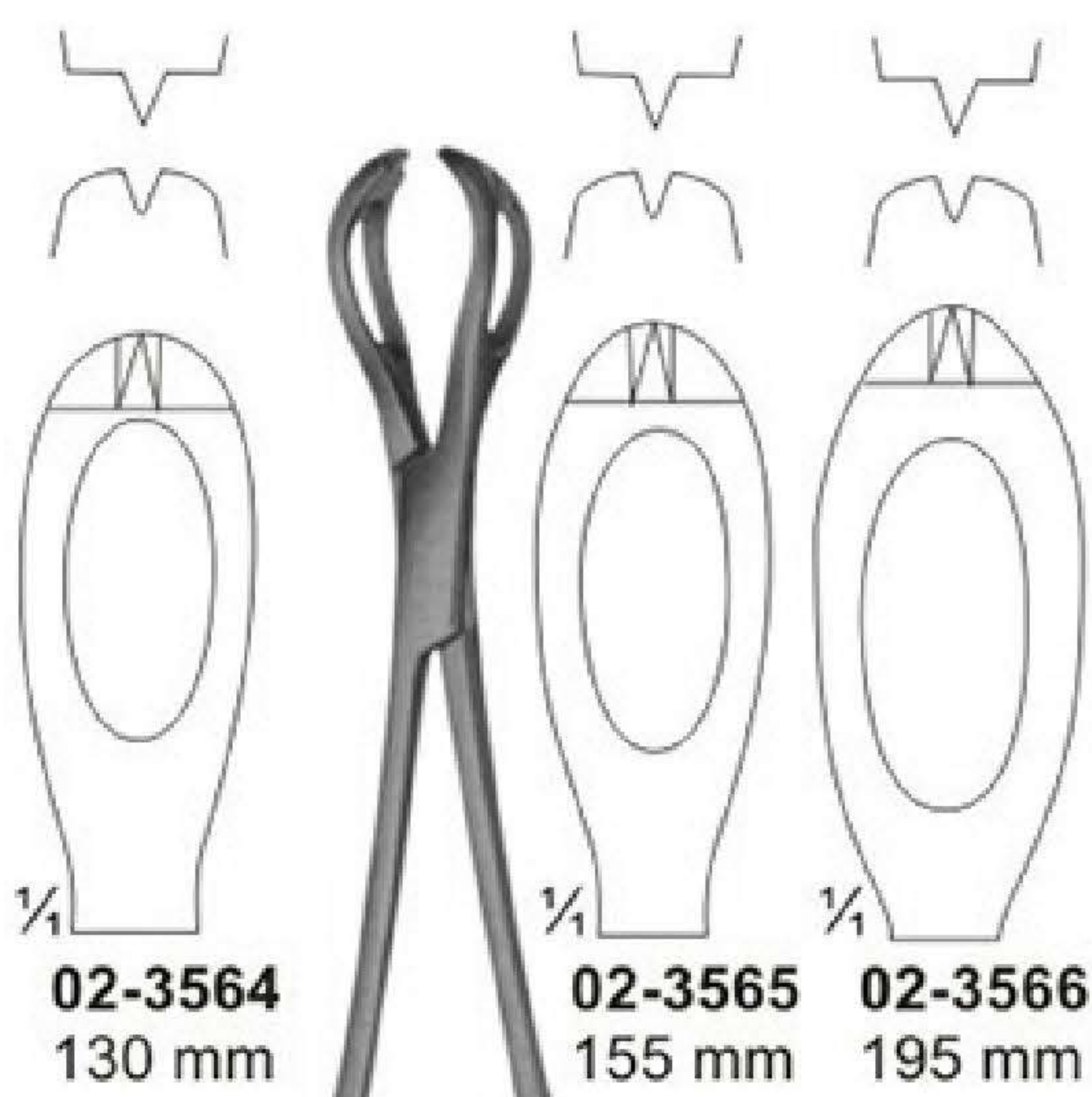

02-3564 - 02-3566
LANE
130 mm



02-3567 - 02-3568
BACKHAUS
80 mm 105 mm

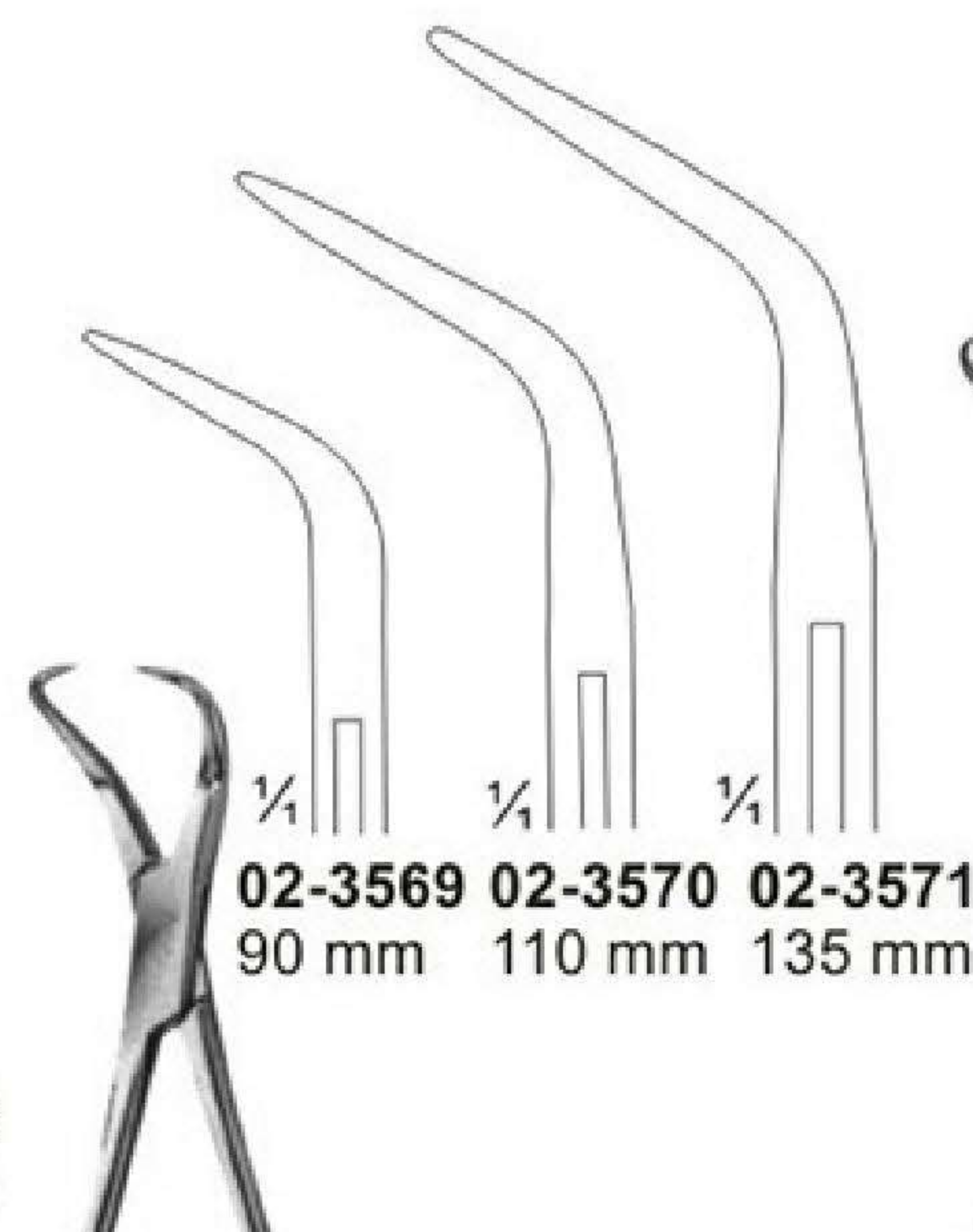

02-3569 - 02-3571
BACKHAUS
90 mm 110 mm 135 mm



02-3572
BACKHAUS-KOCHER
135 mm

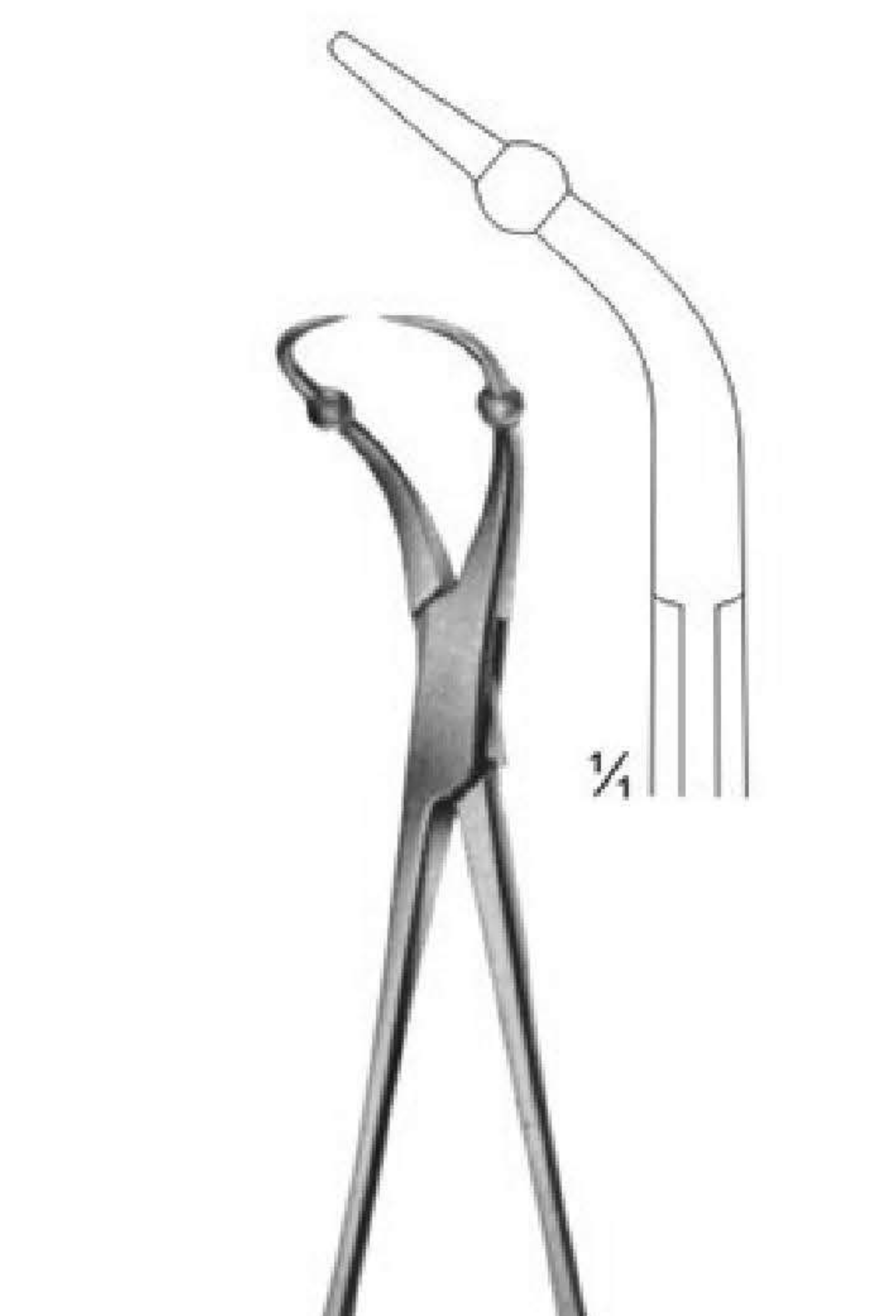

02-3573
ROEDER
160 mm

Towel Clamps and Safety Pins.

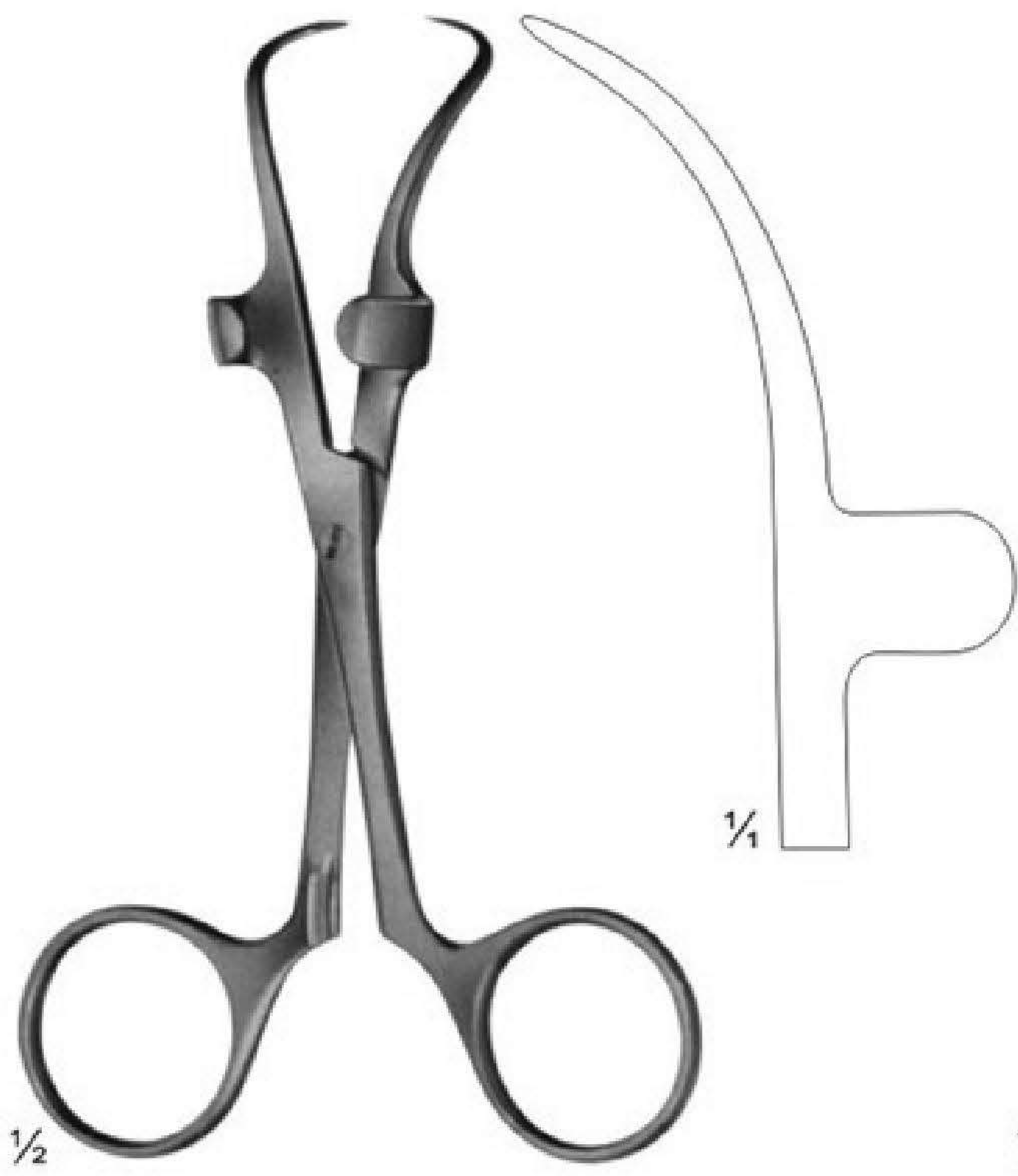

02-3574
 ROBIN
 with holders for tubing
 up to 13 mm
 135 mm



02-3575
 with clip for tubing
 up to 15 mm
 110 mm



02-3576
 LORNA
 non perforating
 130 mm



02-3577
 for paper cloths
 140 mm



02-3578
 BUNT
 105 mm

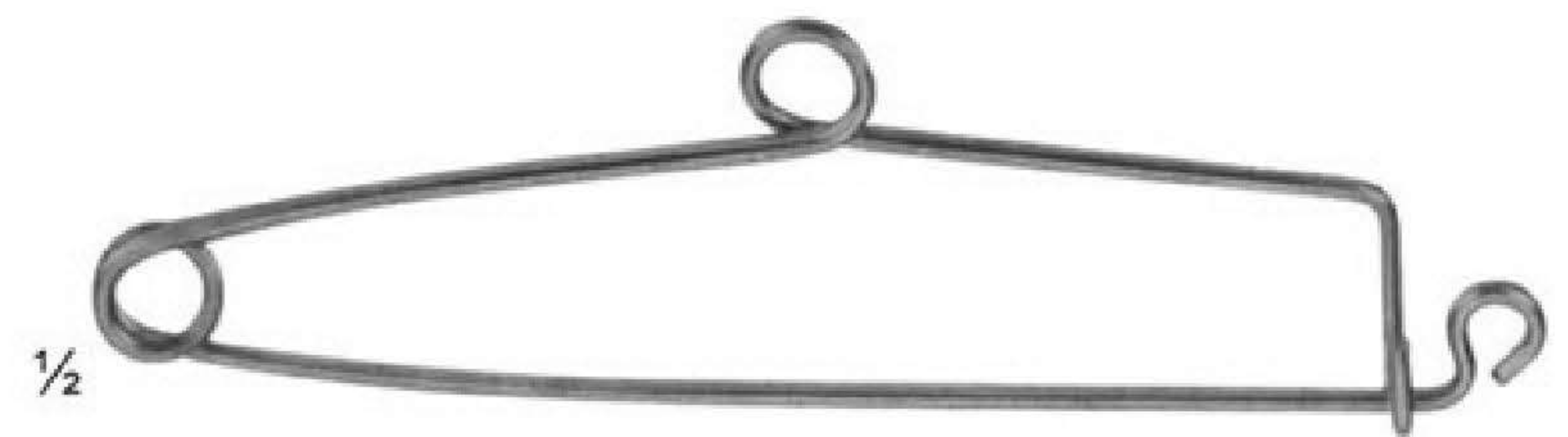

02-3579
 MAYO
 140 mm

Muller Vessel Clips and Bulldog Clamps

Closing force



02-3580
Straight
50g



02-3581
80g



02-3582
Curved
50g

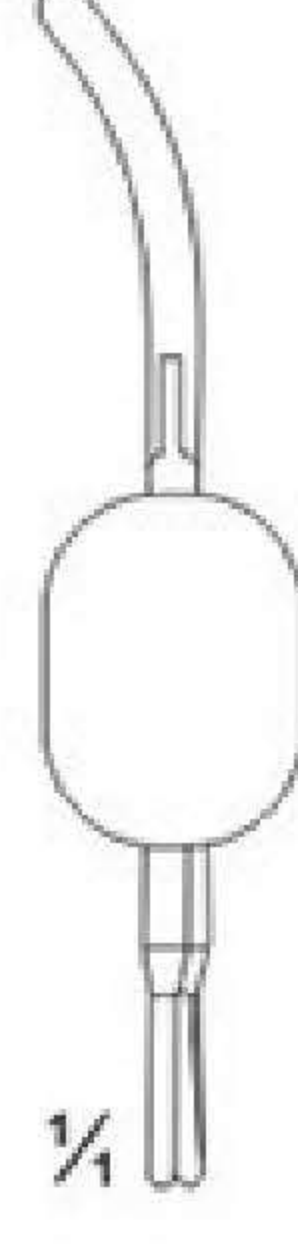

02-3583
80g



02-3584
Curved tips
50g



02-3585
80g



02-3586
Angled
Shaped
50g



02-3587
80g



02-3588
Muller
Knee-bent
50g

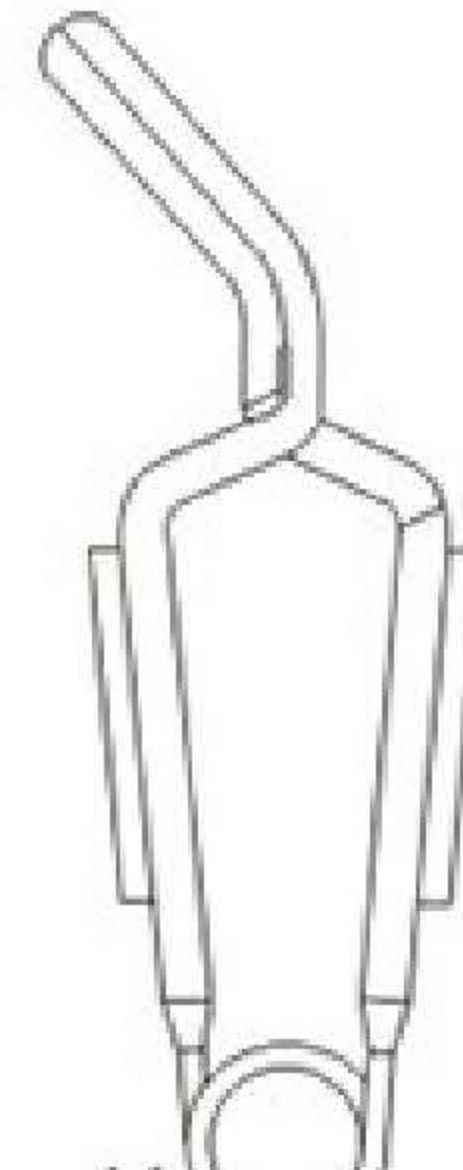

02-3589
80g



02-3590
Muller
Ligature Forceps



Jaw, cross
serrated
Jaws profiles
finally cross-
serrated.

Non-traumatic vessel clips, temporary.



DIEFFENBACH

1/4

02-3591
38 mm
48 mm

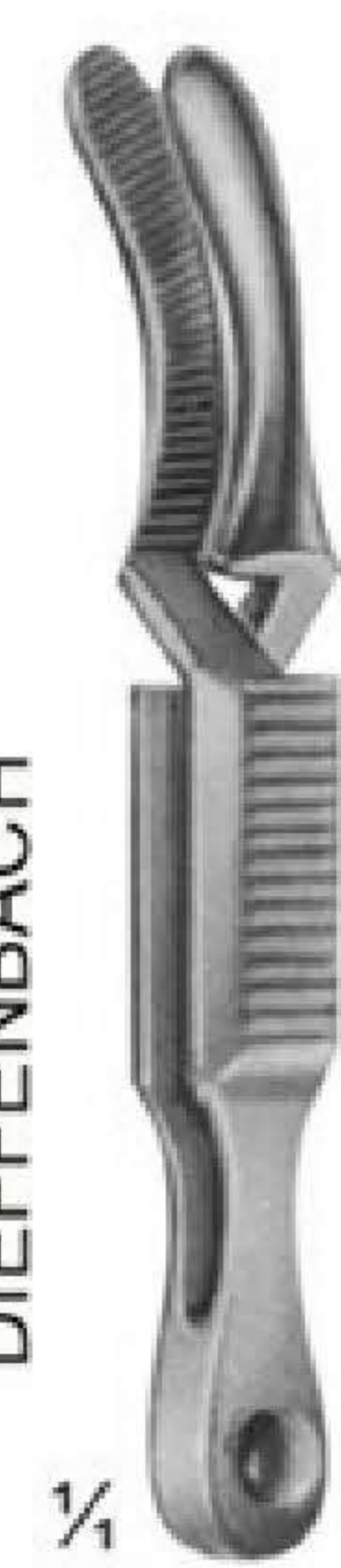

DIEFFENBACH

1/4

02-3592
38 mm
48 mm

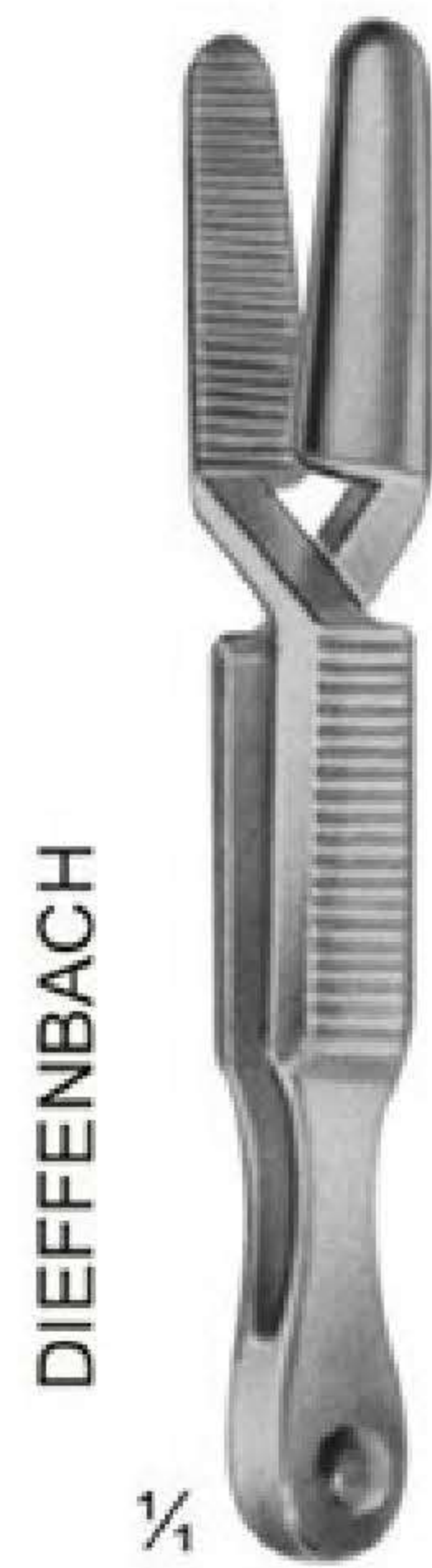

DIEFFENBACH

1/4

02-3593
58 mm

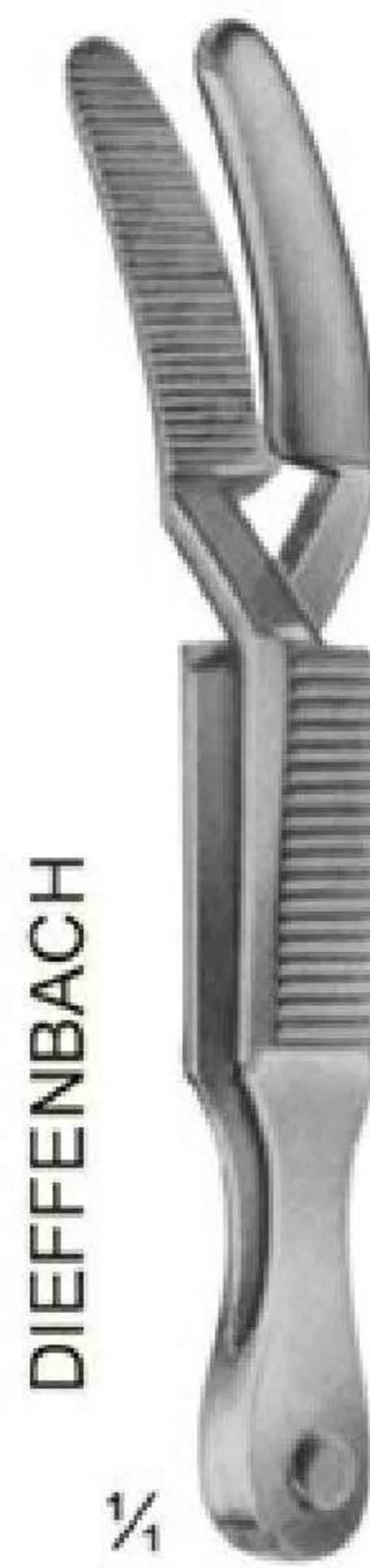

DIEFFENBACH

1/4

02-3594
58 mm



JOHNS-HOPKINS

1/4

02-3595 - 02-3601

- 02-3595 38 mm
- 02-3596 48 mm
- 02-3597 56 mm
- 02-3598 63 mm
- 02-3599 70 mm
- 02-3600 80 mm
- 02-3601 91 mm



1/4

02-3602
DE BAKEY-
HESS
Length of
Jaws 20 mm

Bulldog Clamps

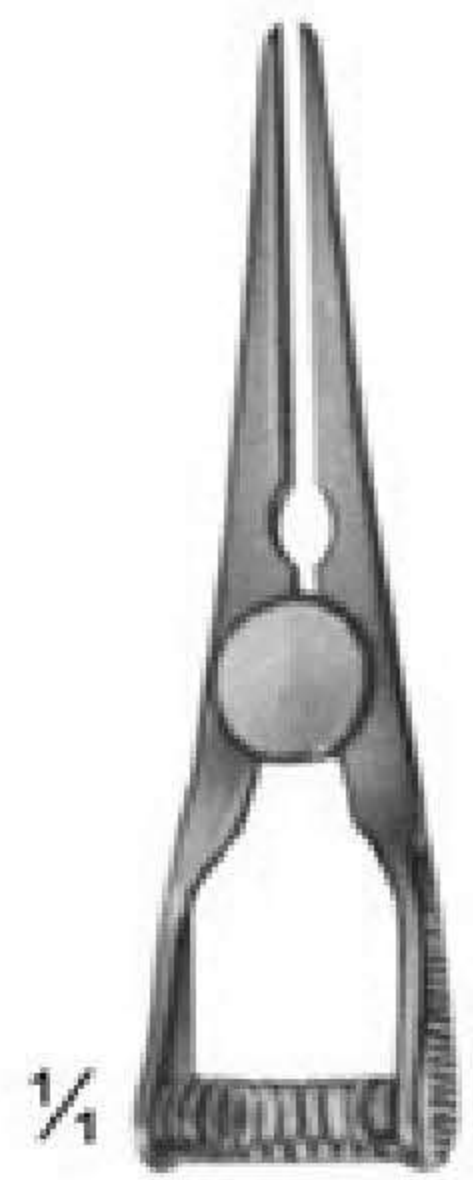

02-3603
35 mm

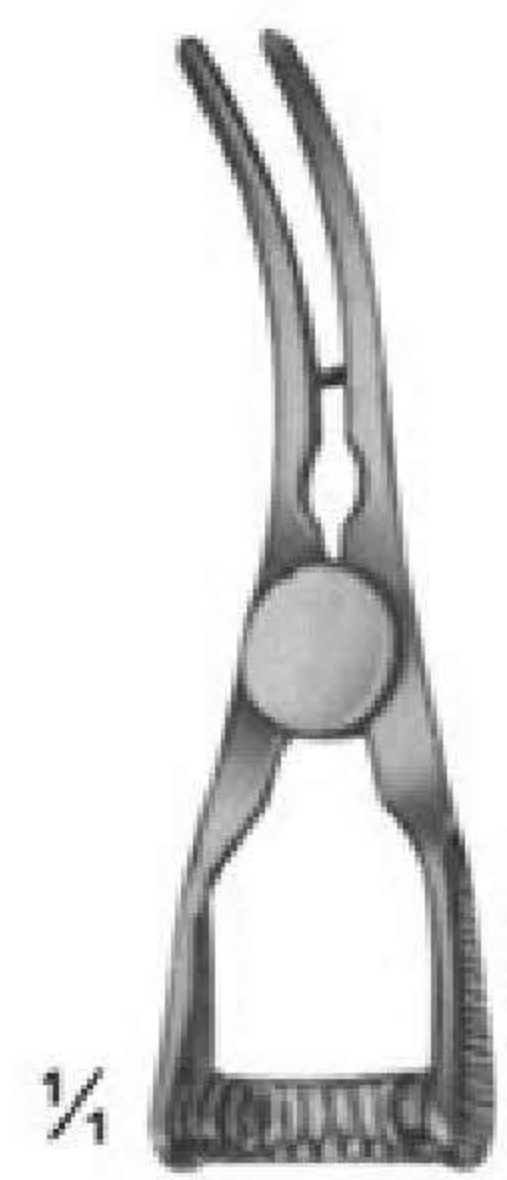

02-3604
35 mm

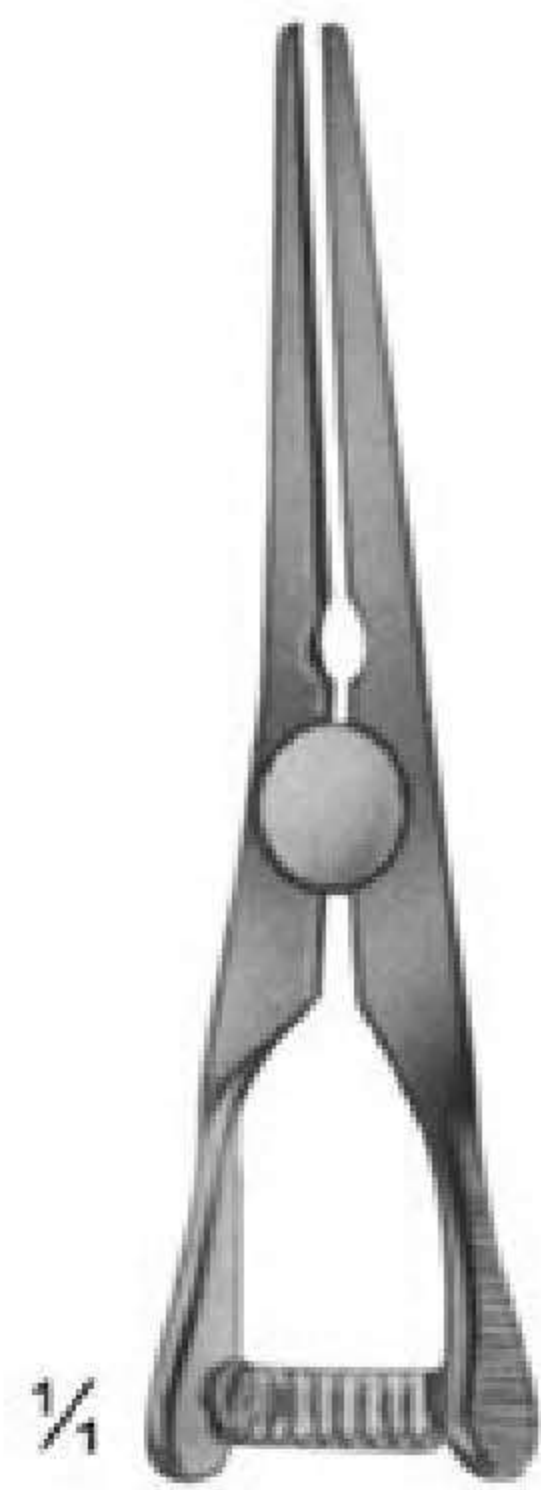

02-3605
45 mm



02-3606
45 mm

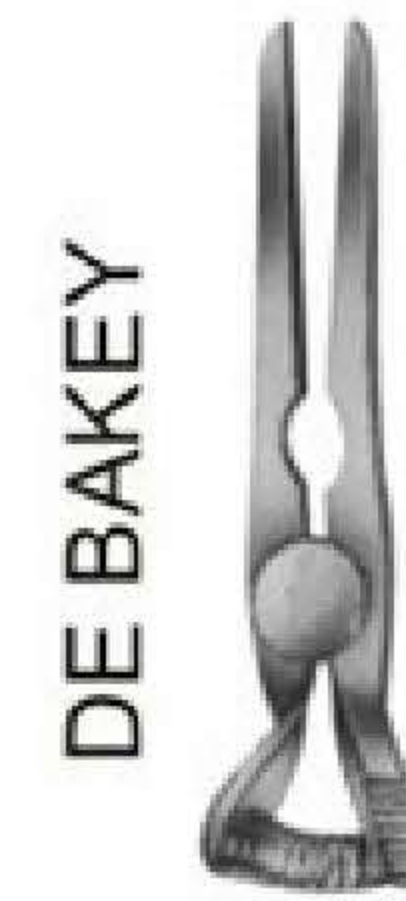

DE BAKEY

02-3607
Length
50 mm
Jaws
27 mm



DE BAKEY

02-3608
Length
48 mm
Jaws
27 mm



75°

02-3609
GLOVER
Length
57 mm
Jaws 35 mm



02-3610
DE BAKEY
Length 73 mm
Jaws 38 mm

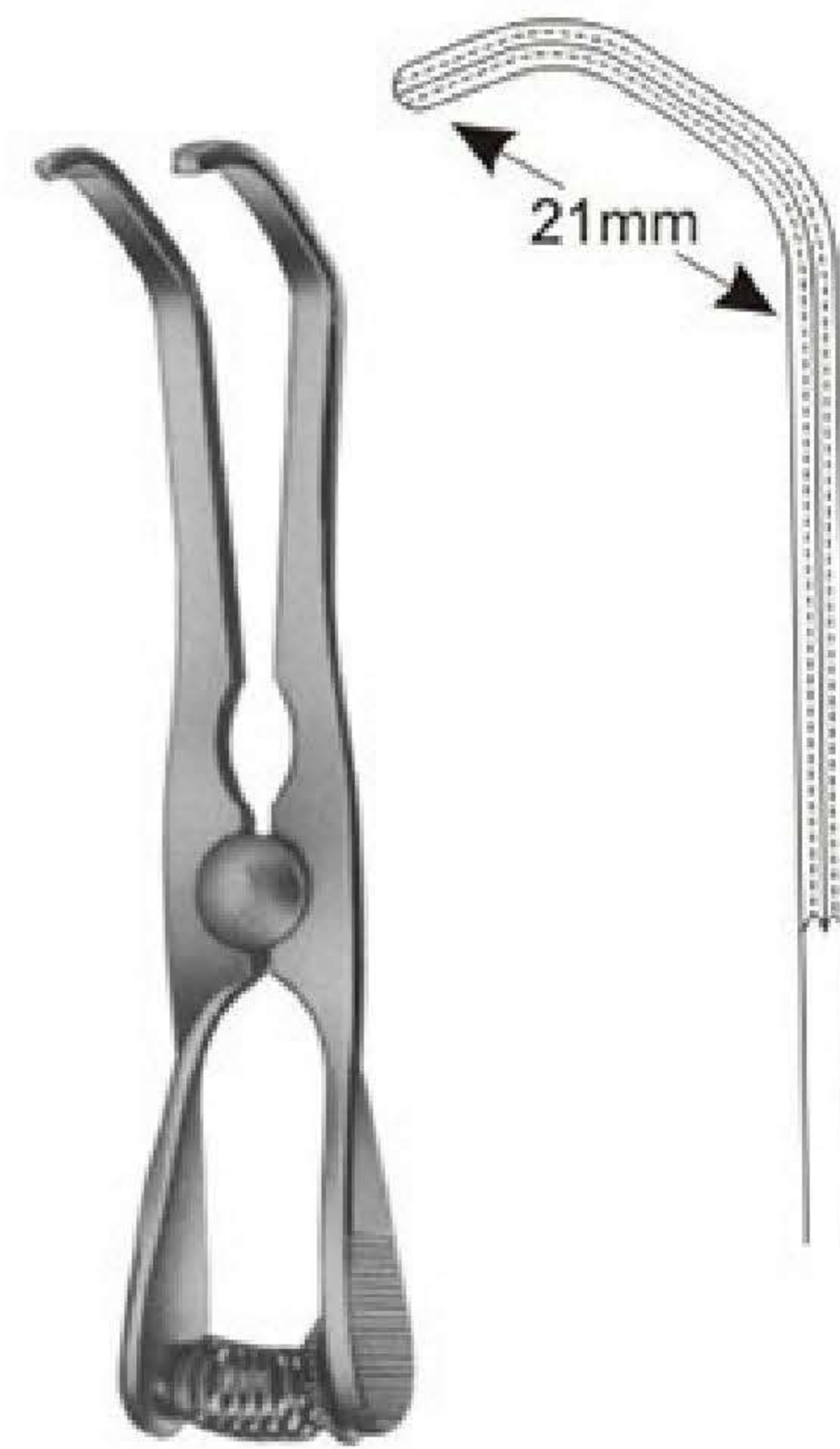

02-3611
DE BAKEY
Length 99 mm
Jaws 63 mm



02-3612
DE BAKEY
Length 95 mm
Jaws 54 mm

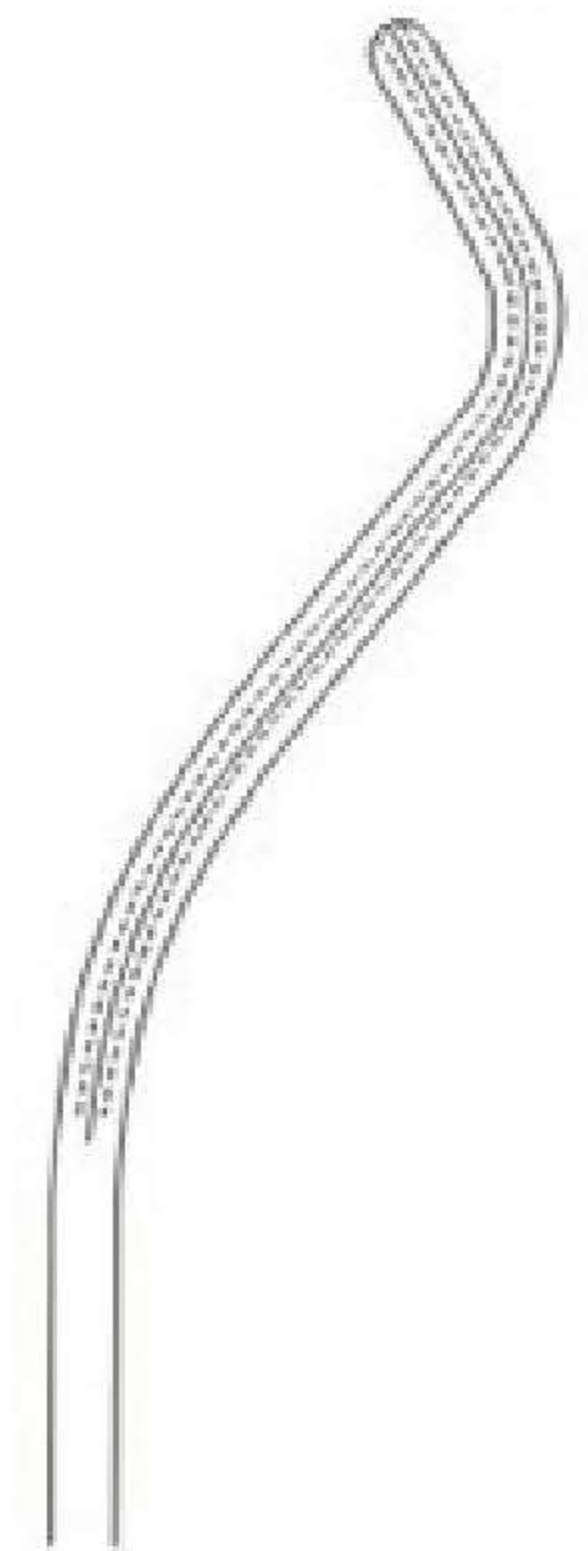

DE BAKEY

	Total length	Length of jaw
02-3613	80mm	25mm
02-3614	90mm	35mm
02-3615	105mm	50mm
02-3616	124mm	68mm



DE BAKEY

	Total length	Length of jaw
02-3617	78mm	25mm
02-3618	86mm	35mm
02-3619	97mm	50mm
02-3620	114mm	68mm

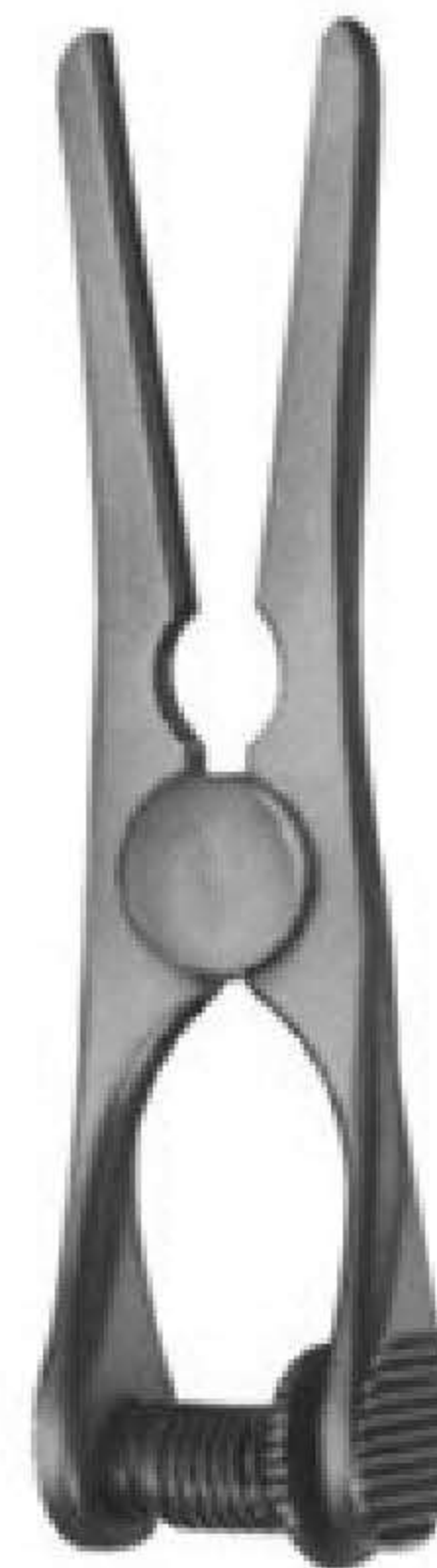

GLOVER

	Total length	Length of jaw
02-3621	68mm	33mm
02-3622	96mm	50mm
02-3623	117mm	69mm



GLOVER

	Total length	Length of jaw
02-3624	65mm	33mm
02-3625	91mm	50mm
02-3626	110mm	69mm

Delicate Haemostatic Forceps



02-3627
CARREL
85 mm



02-3628 - 02-3631
BABY-MOSQUITO
(HARTMANN)
100 mm

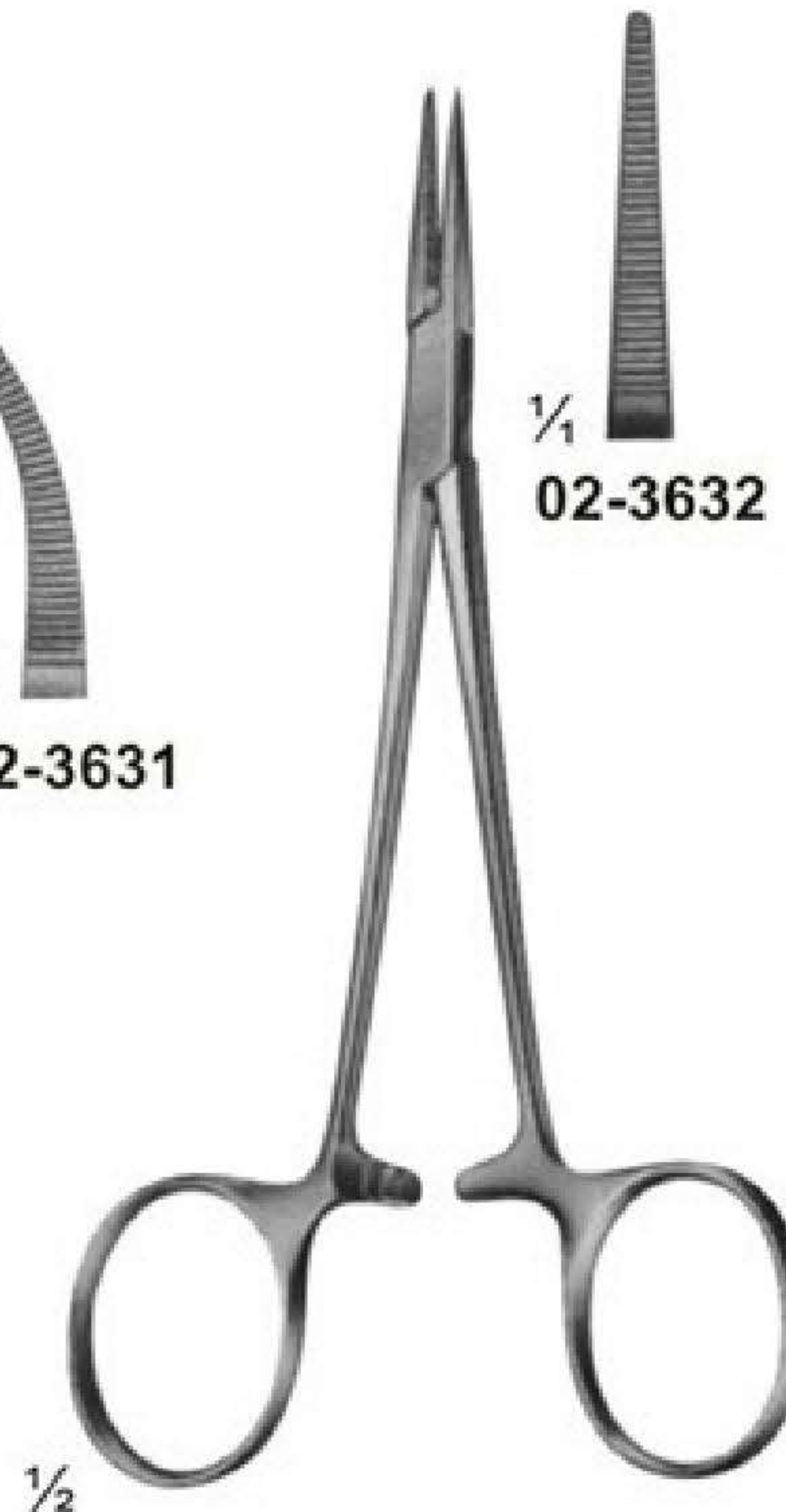

02-3632 - 02-3635
MICRO-HALSTED
125 mm



02-3636 - 02-3639
HALSTED-MOSQUITO
125 mm

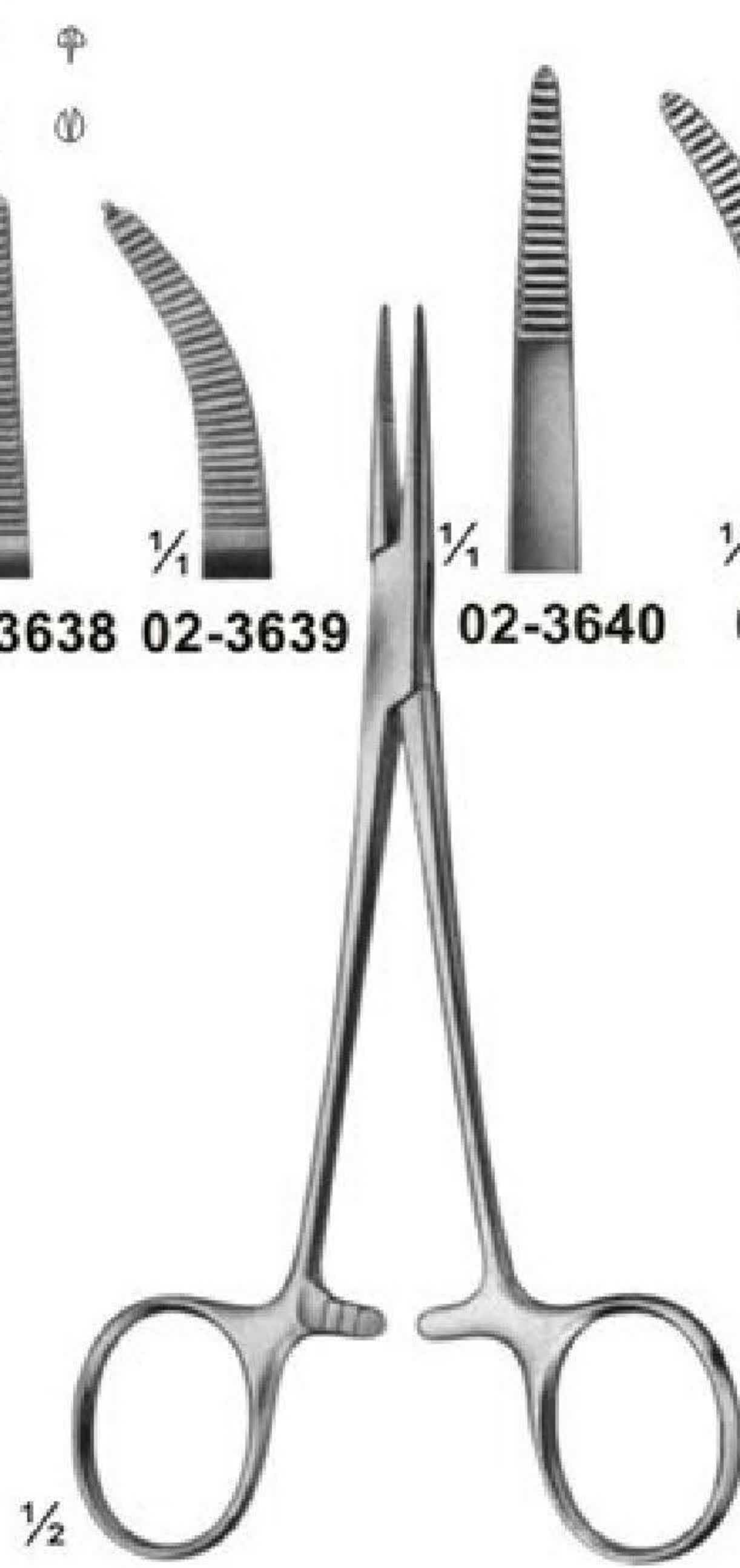

02-3640 - 02-3641
PROVIDENCE-HOSPITAL
140 mm



02-3642 - 02-3643
KELLY
140 mm

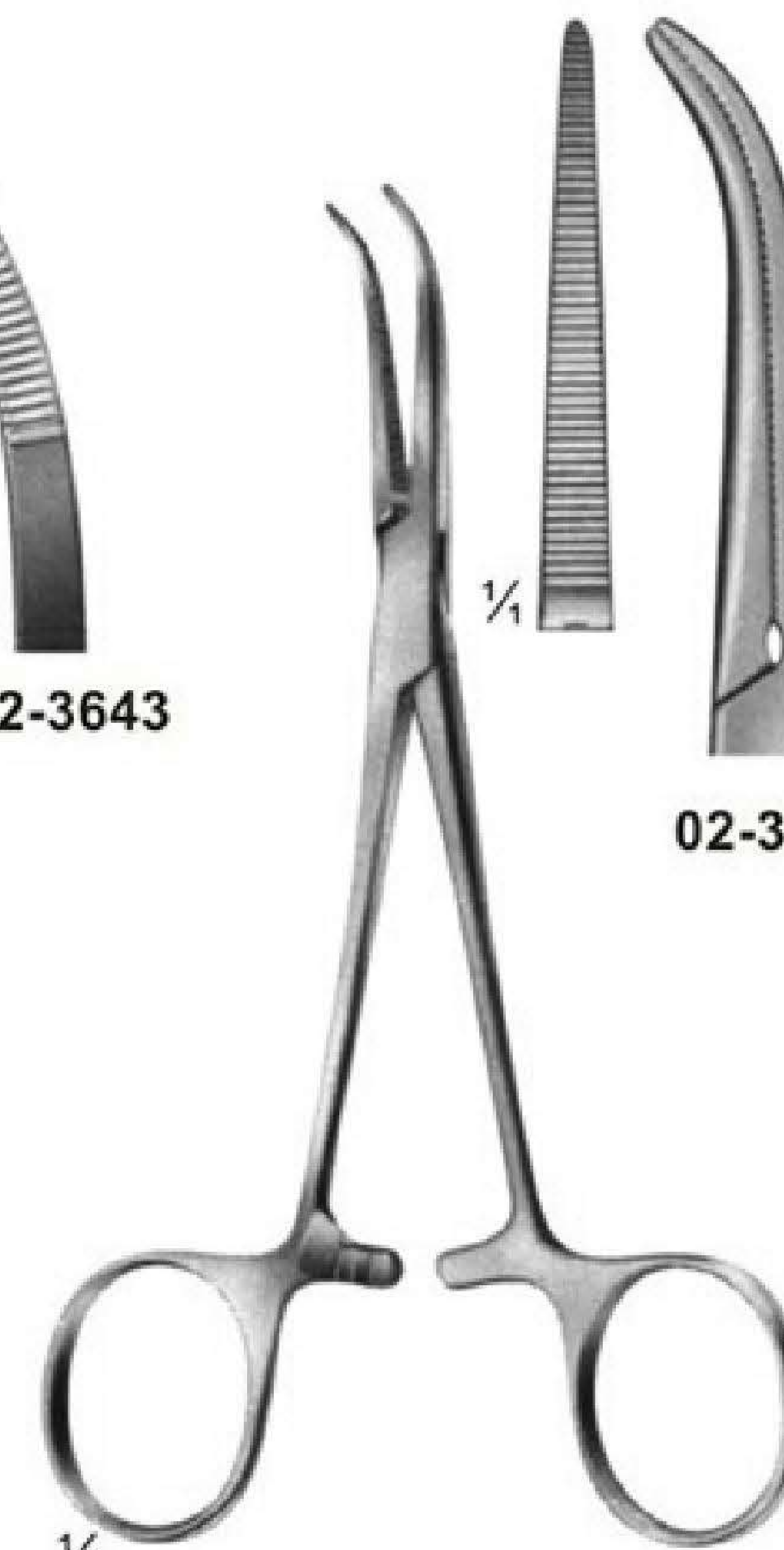

02-3644 - 02-3645
DANDY
Curved sideways
140 mm

Delicate Haemostatic Forceps

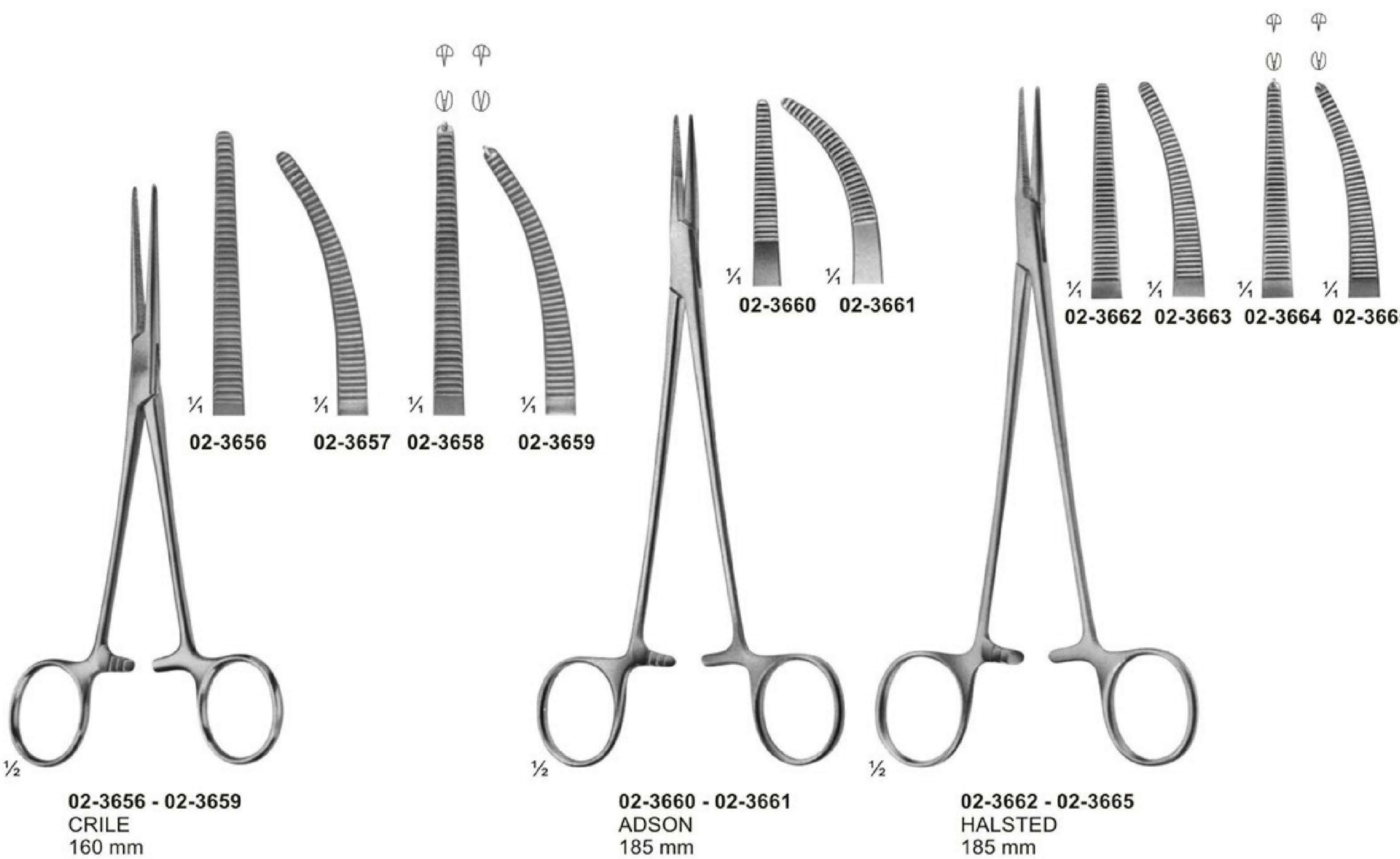
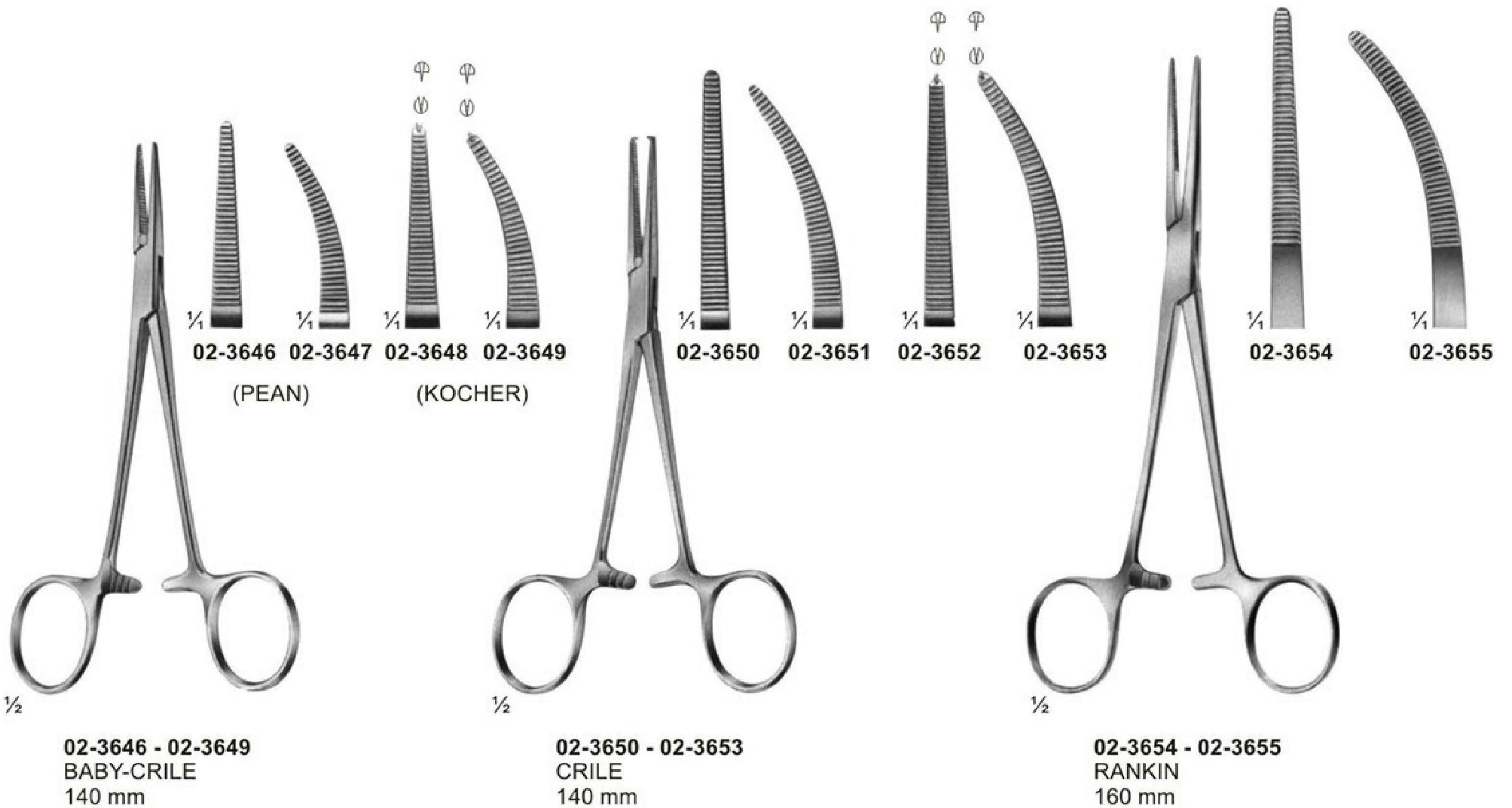

Delicate Haemostatic Forceps

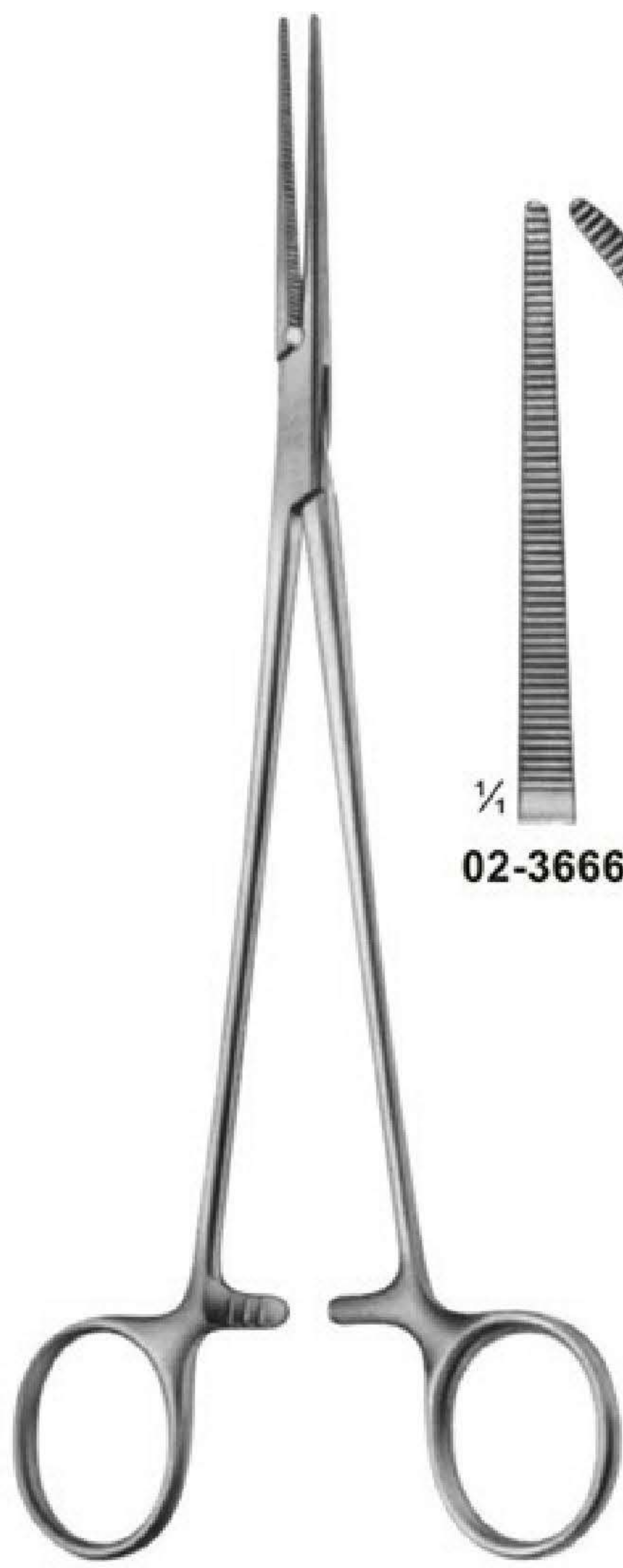

$\frac{1}{2}$
02-3666 - 02-3669
 HALSTED-MOSQUITO
 200 mm

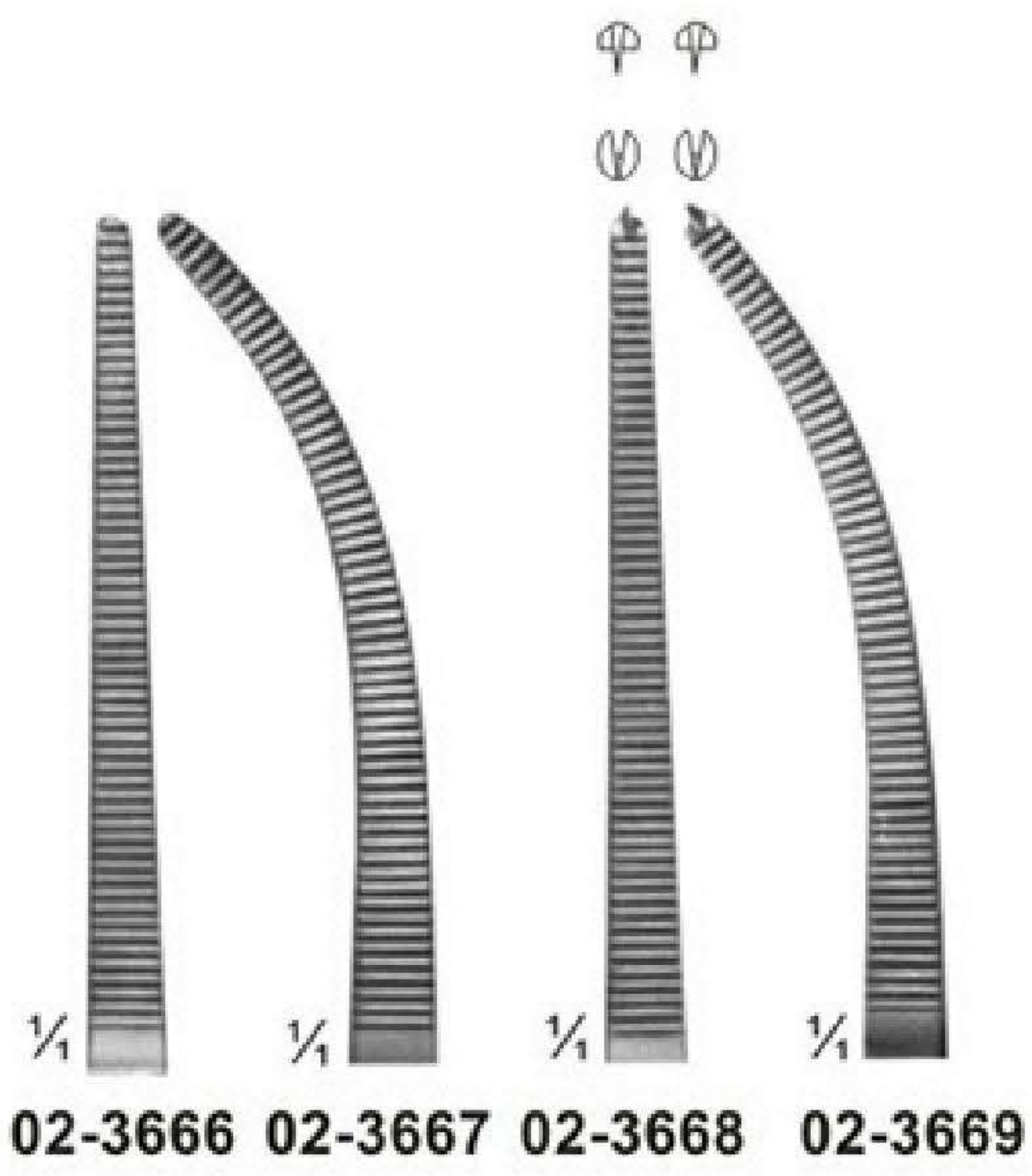

$\frac{1}{4}$ $\frac{1}{4}$ $\frac{1}{4}$ $\frac{1}{4}$
02-3666 02-3667 02-3668 02-3669



02-3670 - 02-3674
 HEISS

$\frac{1}{2}$

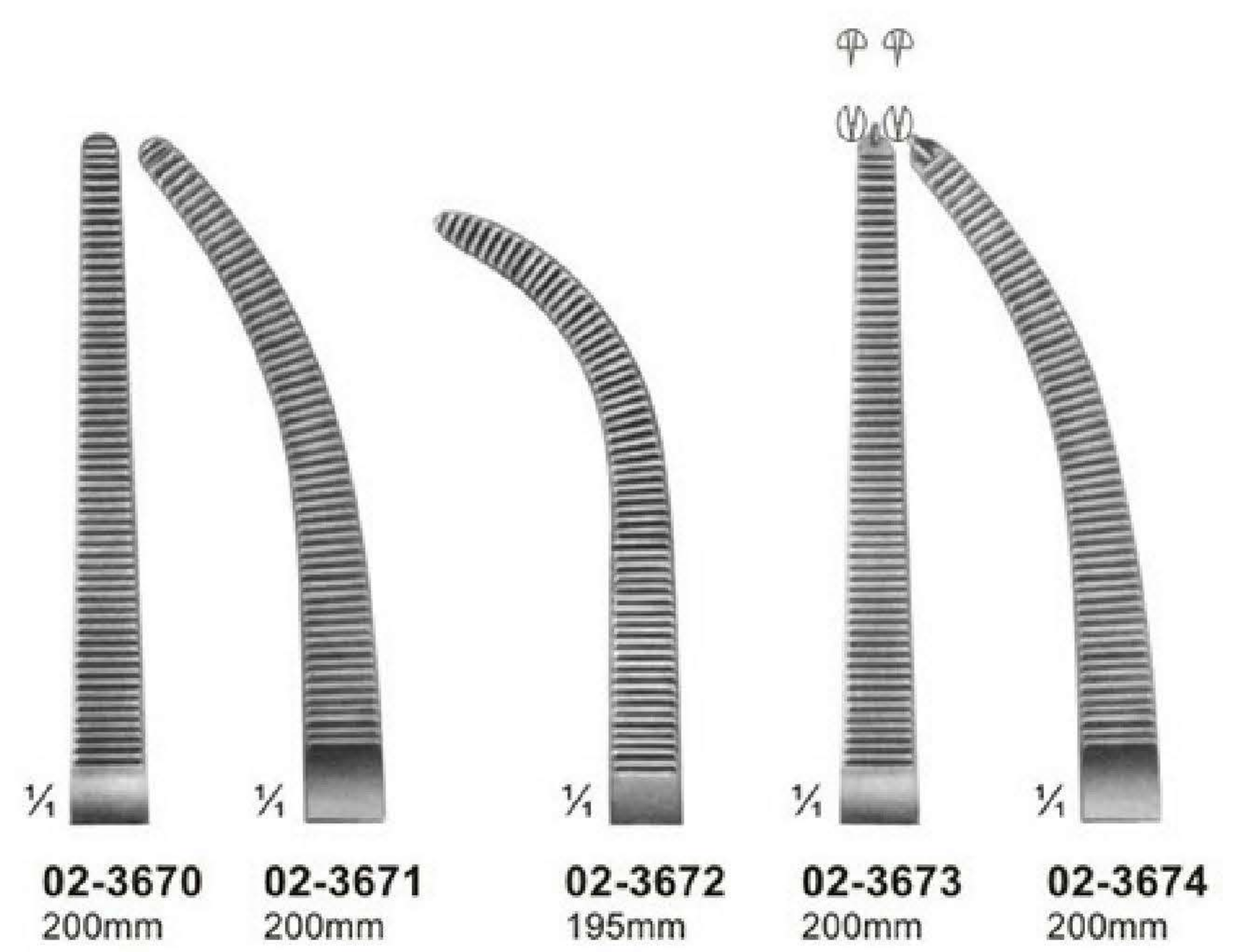

$\frac{1}{4}$ $\frac{1}{4}$ $\frac{1}{4}$ $\frac{1}{4}$ $\frac{1}{4}$
02-3670 02-3671 02-3672 02-3673 02-3674
 200mm 200mm 195mm 200mm 200mm



$\frac{1}{2}$

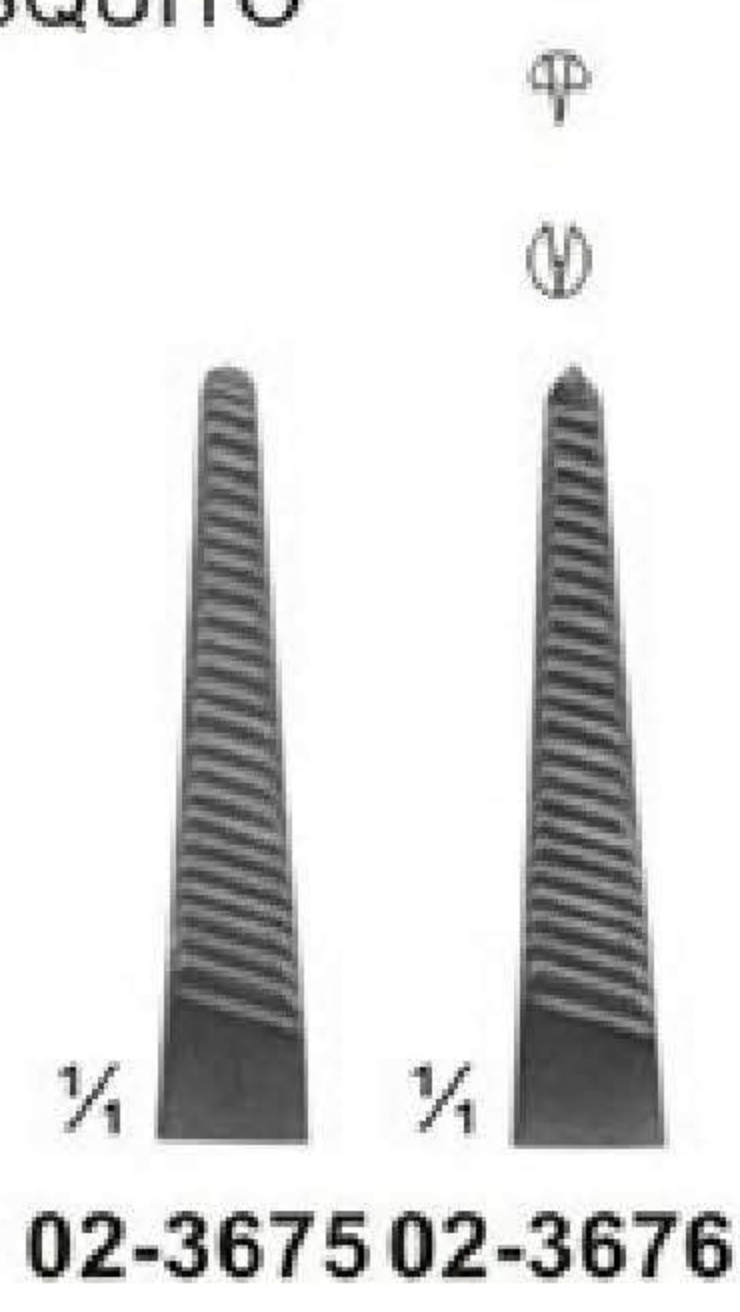

$\frac{1}{4}$ $\frac{1}{4}$
02-3675 02-3676

02-3675 - 02-3676
 HALSTED
 215 mm

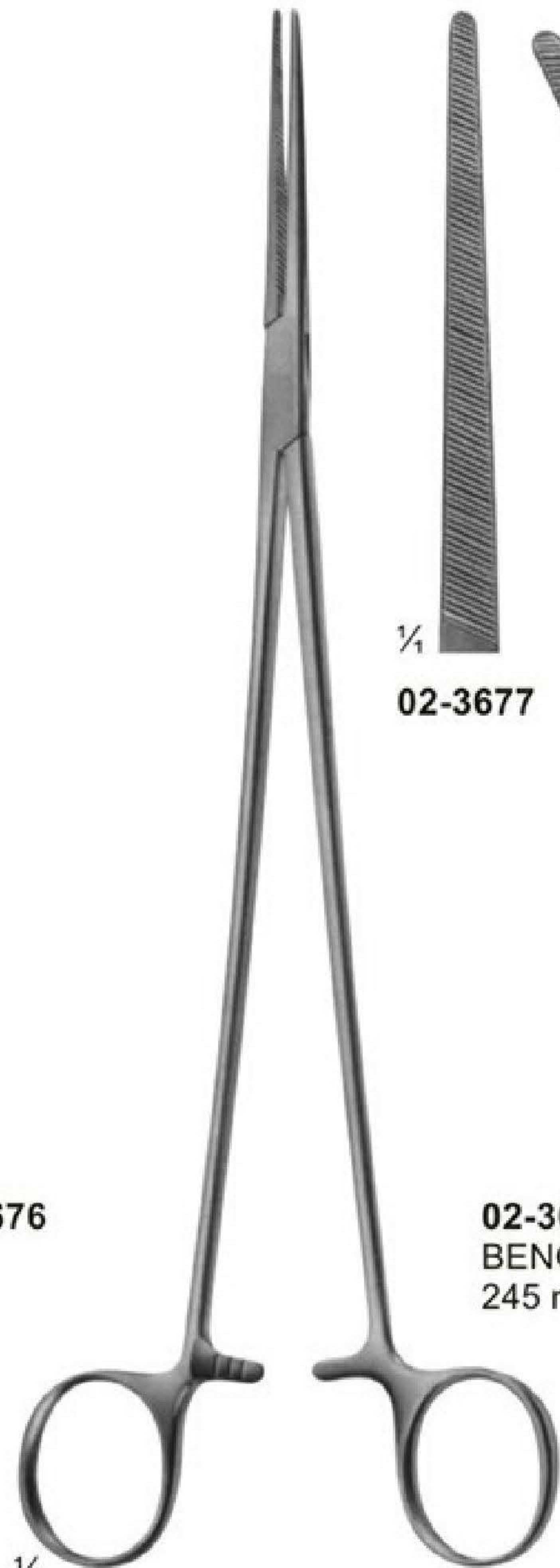

$\frac{1}{2}$

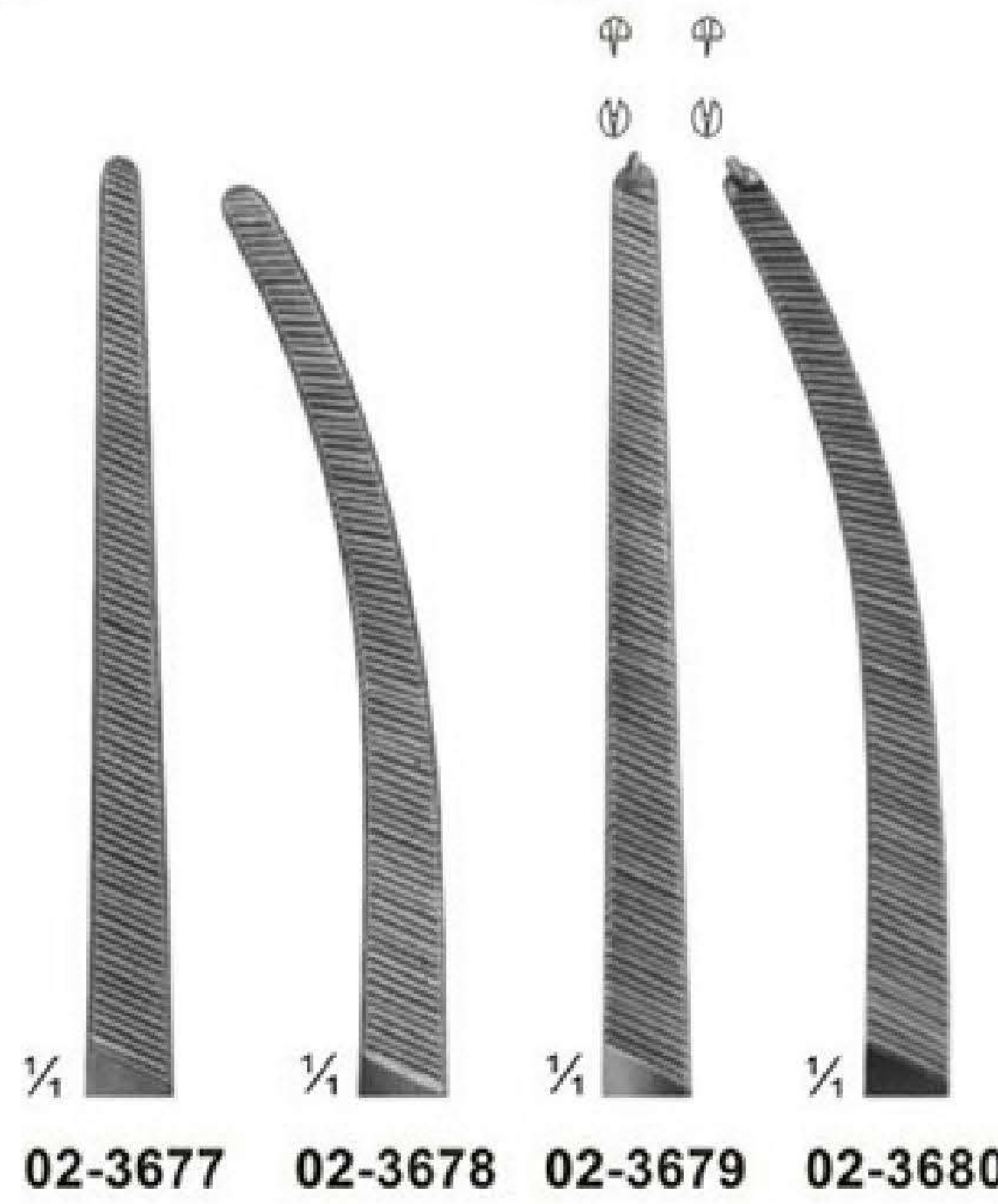

$\frac{1}{4}$ $\frac{1}{4}$ $\frac{1}{4}$ $\frac{1}{4}$
02-3677 02-3678 02-3679 02-3680

02-3677 - 02-3680
 BENGOLEA
 245 mm

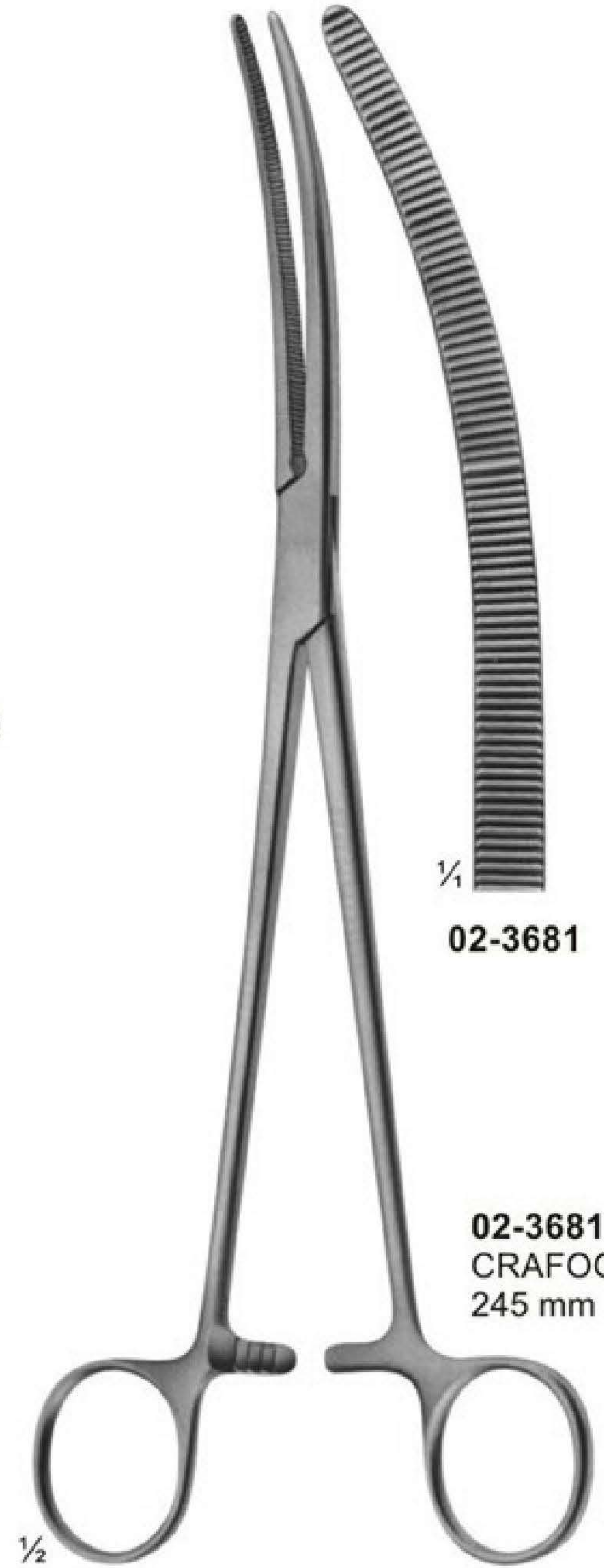

$\frac{1}{2}$



$\frac{1}{4}$
02-3681

02-3681
 CRAFOORD
 245 mm

Haemostatic Forceps

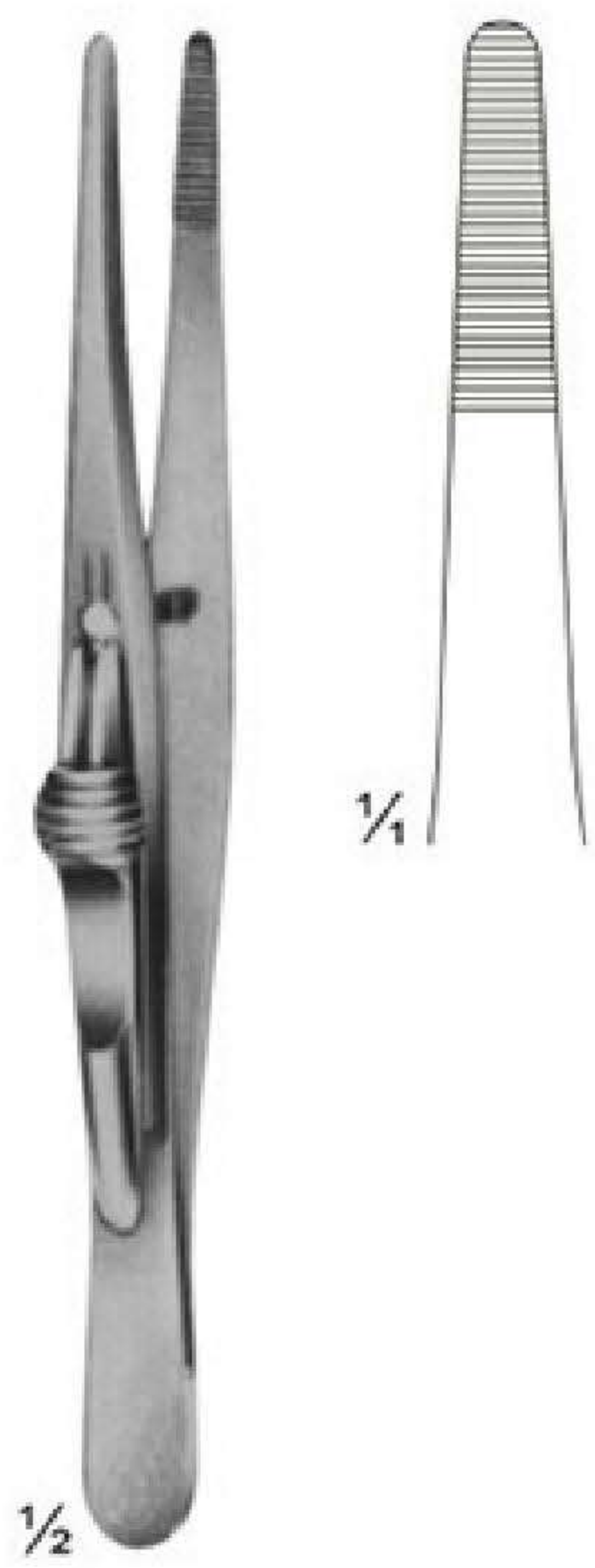

02-3682
FRICKE
Artery forceps
130 mm

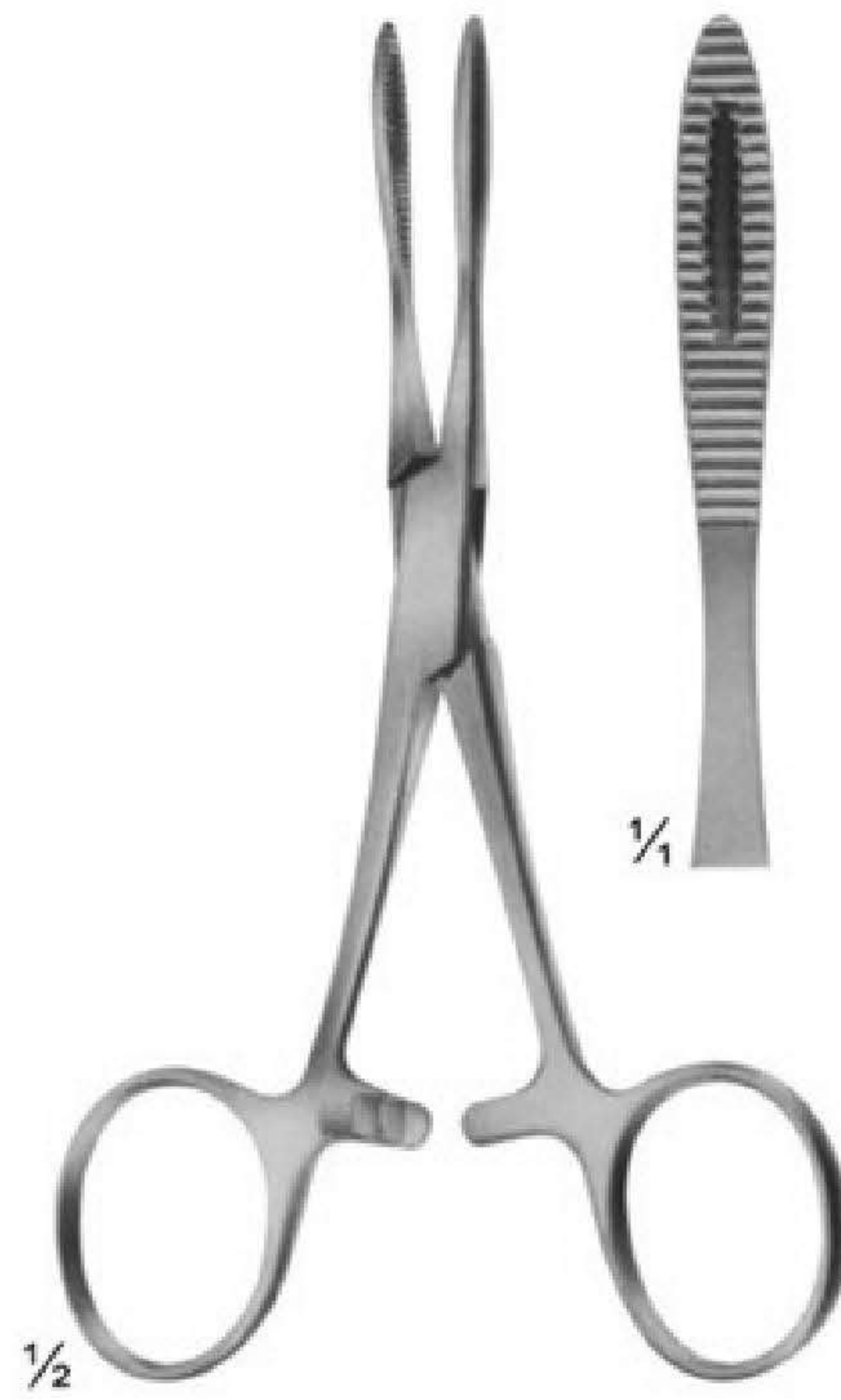

02-3683
KRONLEIN
130 mm

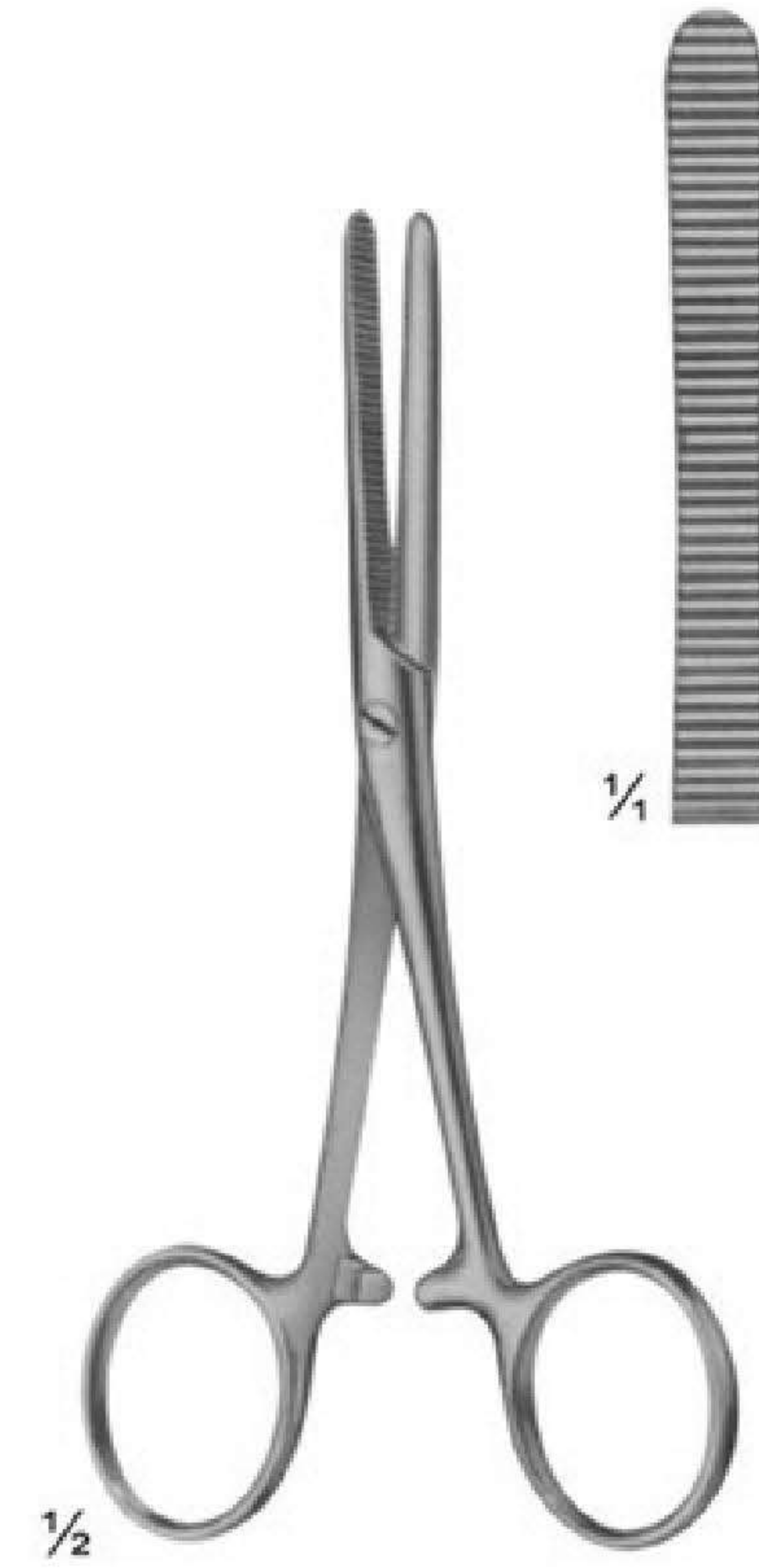

02-3684
PEAN
125 mm

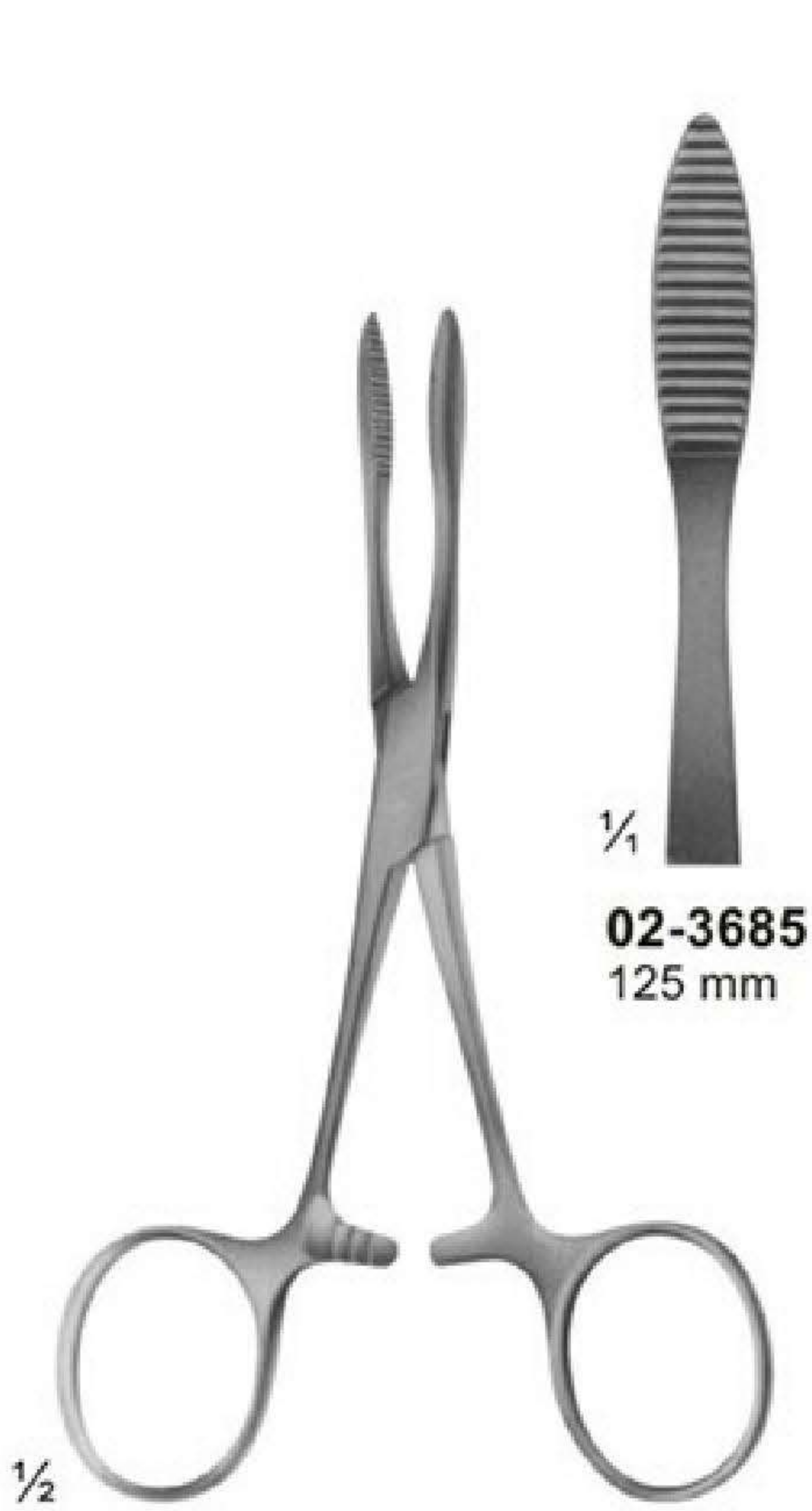

02-3685 - 02-3686
PEAN

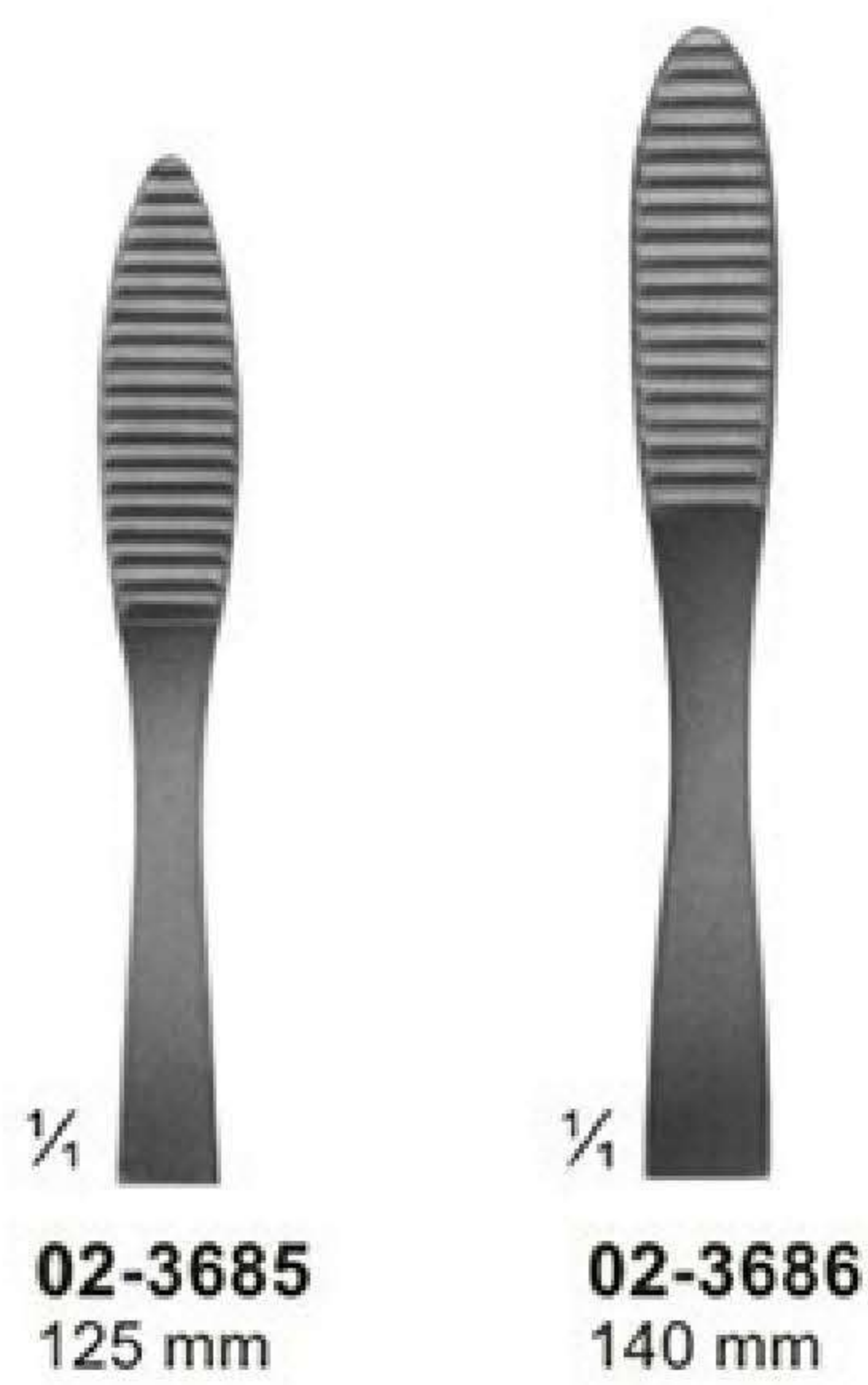

02-3686
140 mm

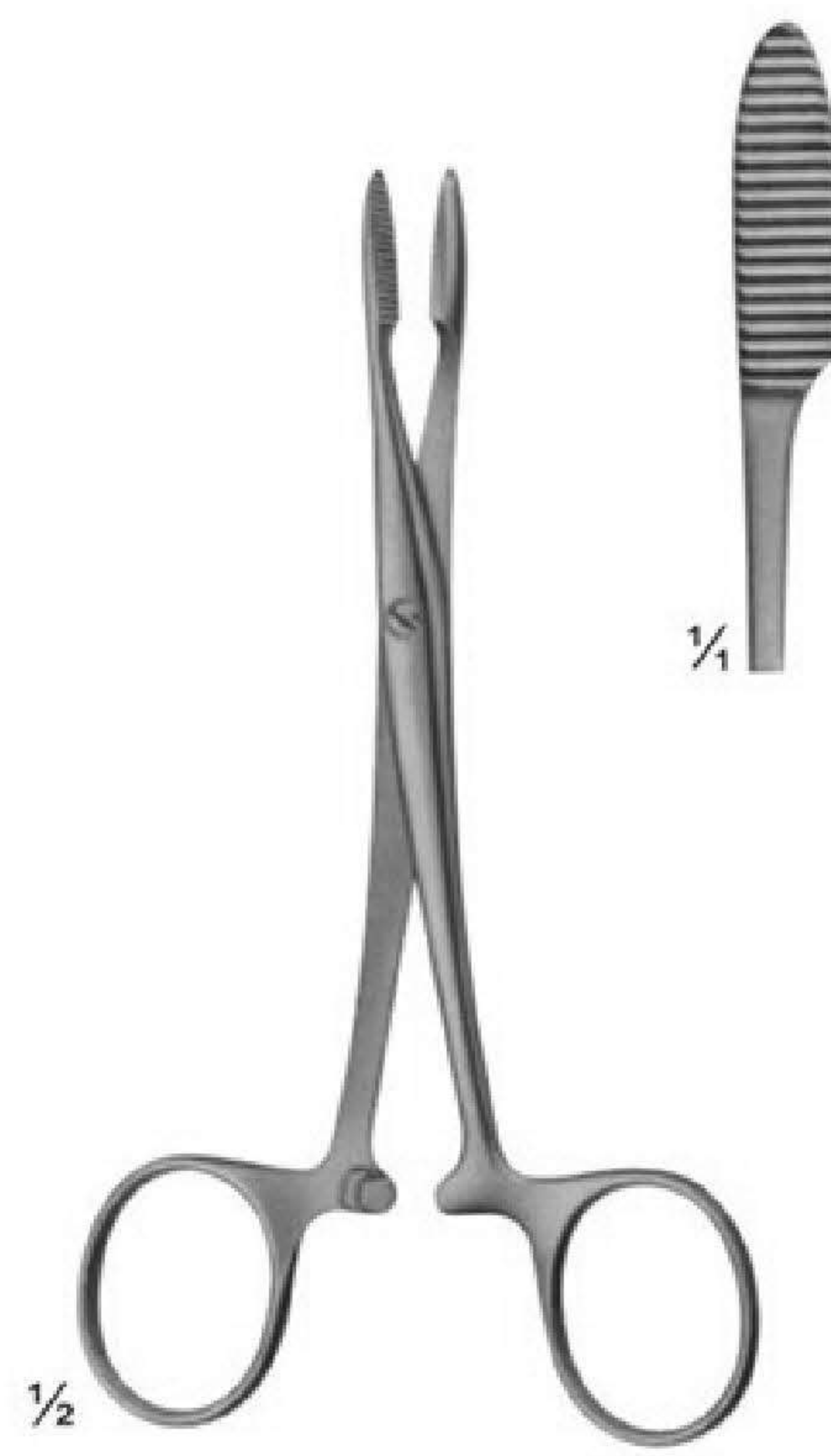

02-3687
PEAN
125mm

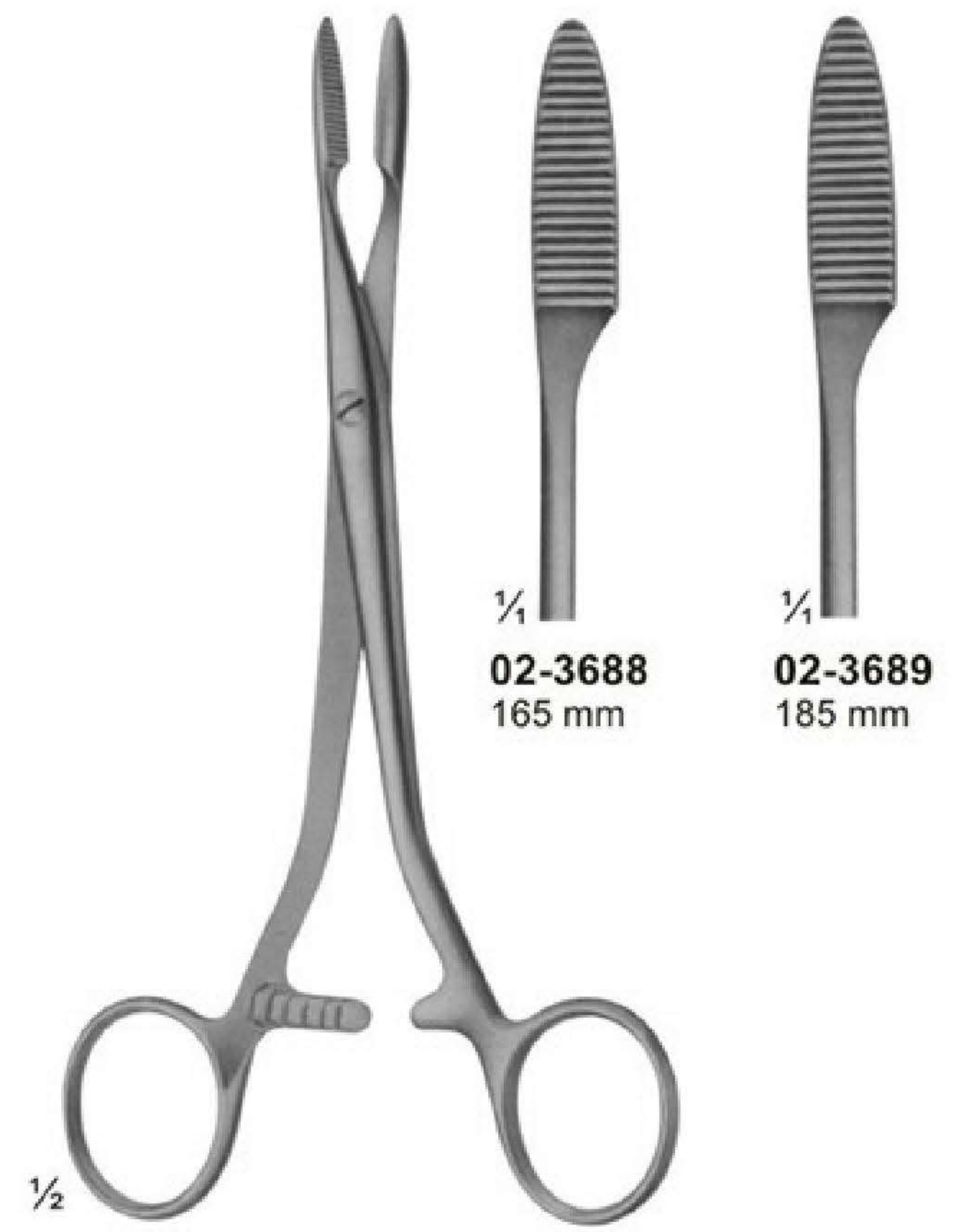

02-3688 - 02-3689
PEAN

02-3688
165 mm

02-3689
185 mm

Haemostatic Forceps

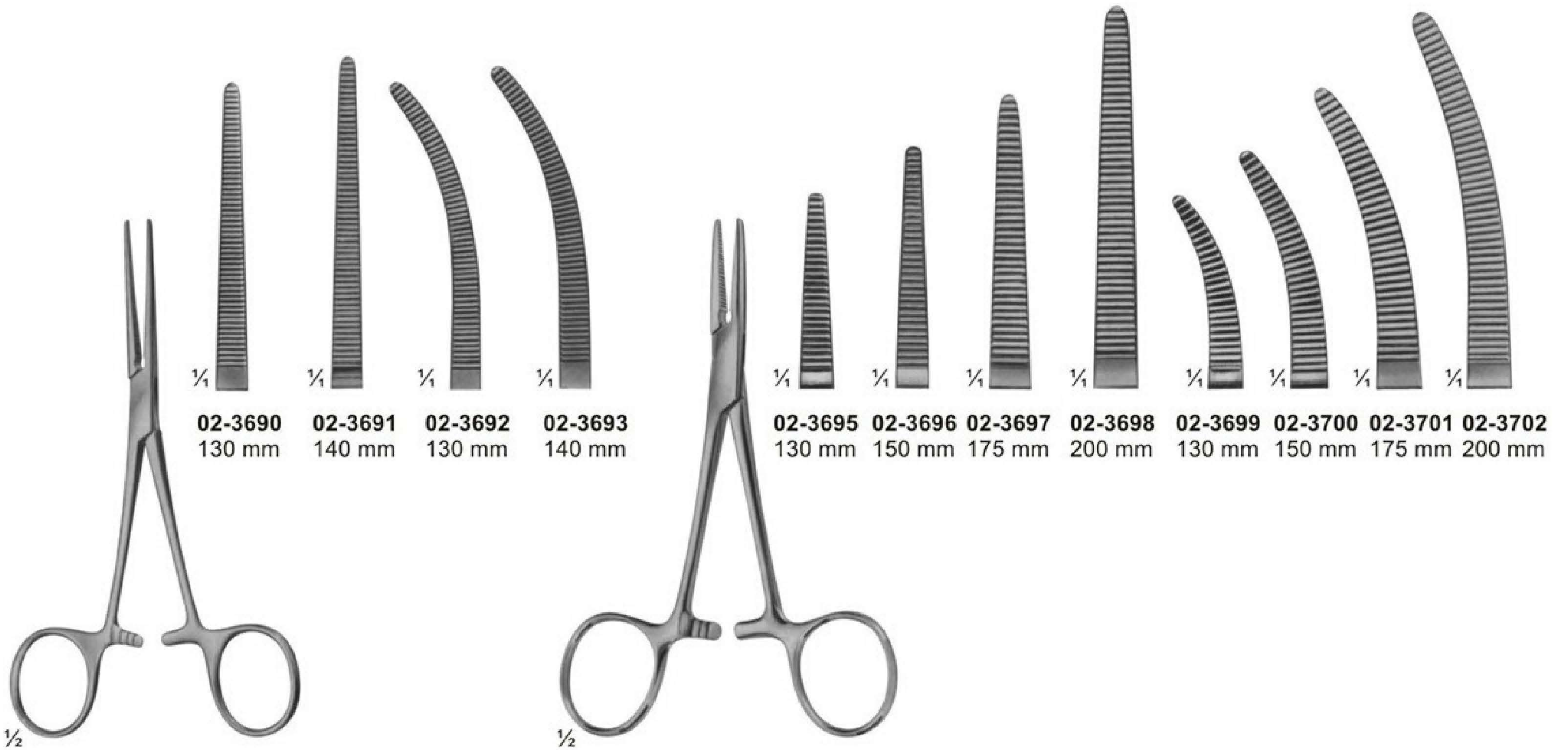

02-3690 130 mm
02-3691 140 mm
02-3692 130 mm
02-3693 140 mm

02-3695 130 mm
02-3696 150 mm
02-3697 175 mm
02-3698 200 mm
02-3699 130 mm
02-3700 150 mm
02-3701 175 mm
02-3702 200 mm

02-3690 - 02-3693
PEAN
Slender type

02-3694 - 02-3702
SPENCER-WELLS

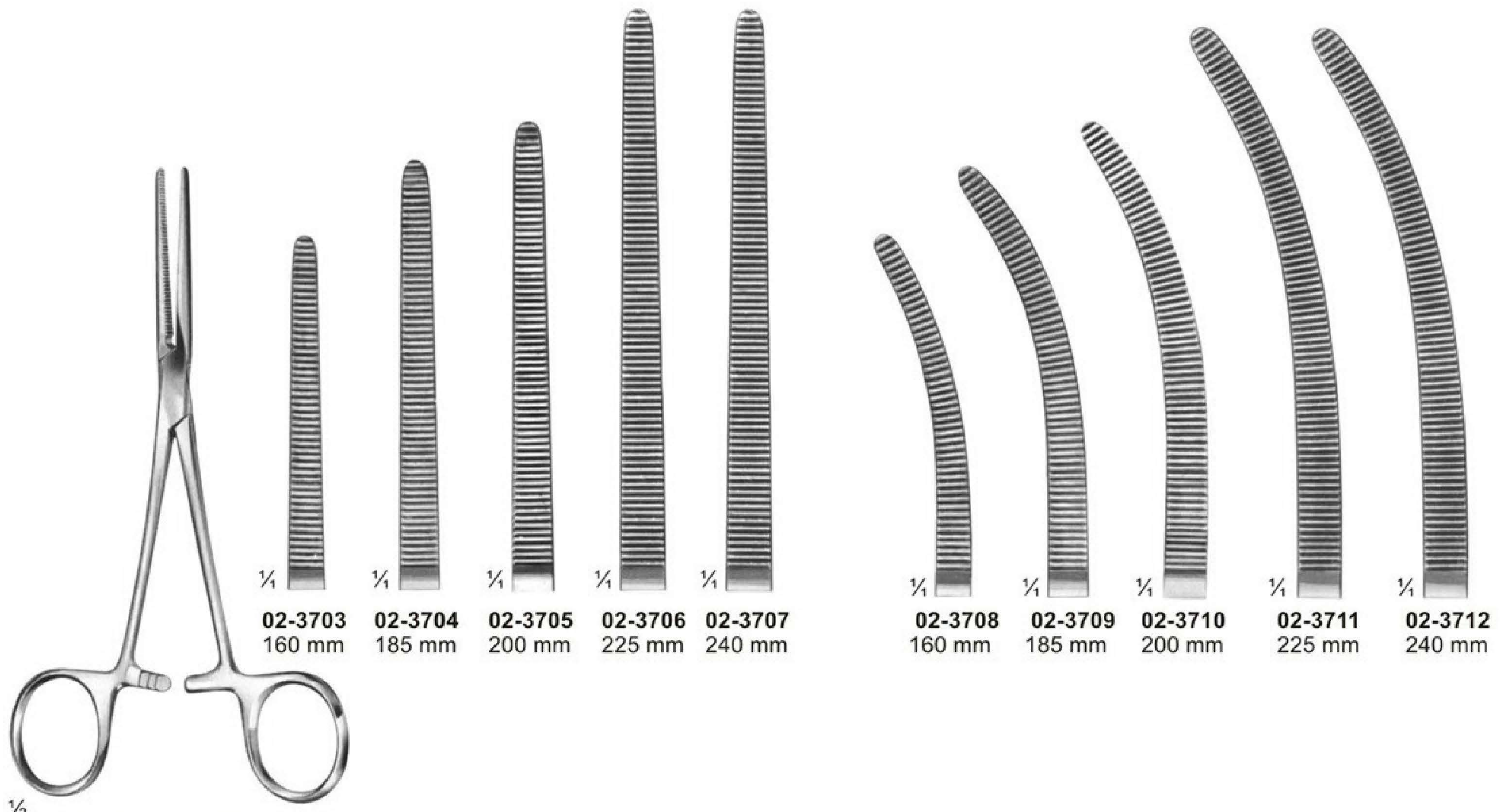

02-3703 160 mm
02-3704 185 mm
02-3705 200 mm
02-3706 225 mm
02-3707 240 mm

02-3708 160 mm
02-3709 185 mm
02-3710 200 mm
02-3711 225 mm
02-3712 240 mm

02-3703 - 02-3712
ROCHESTER-PEAN

Haemostatic Forceps



02-3713 - 02-3718
PEAN

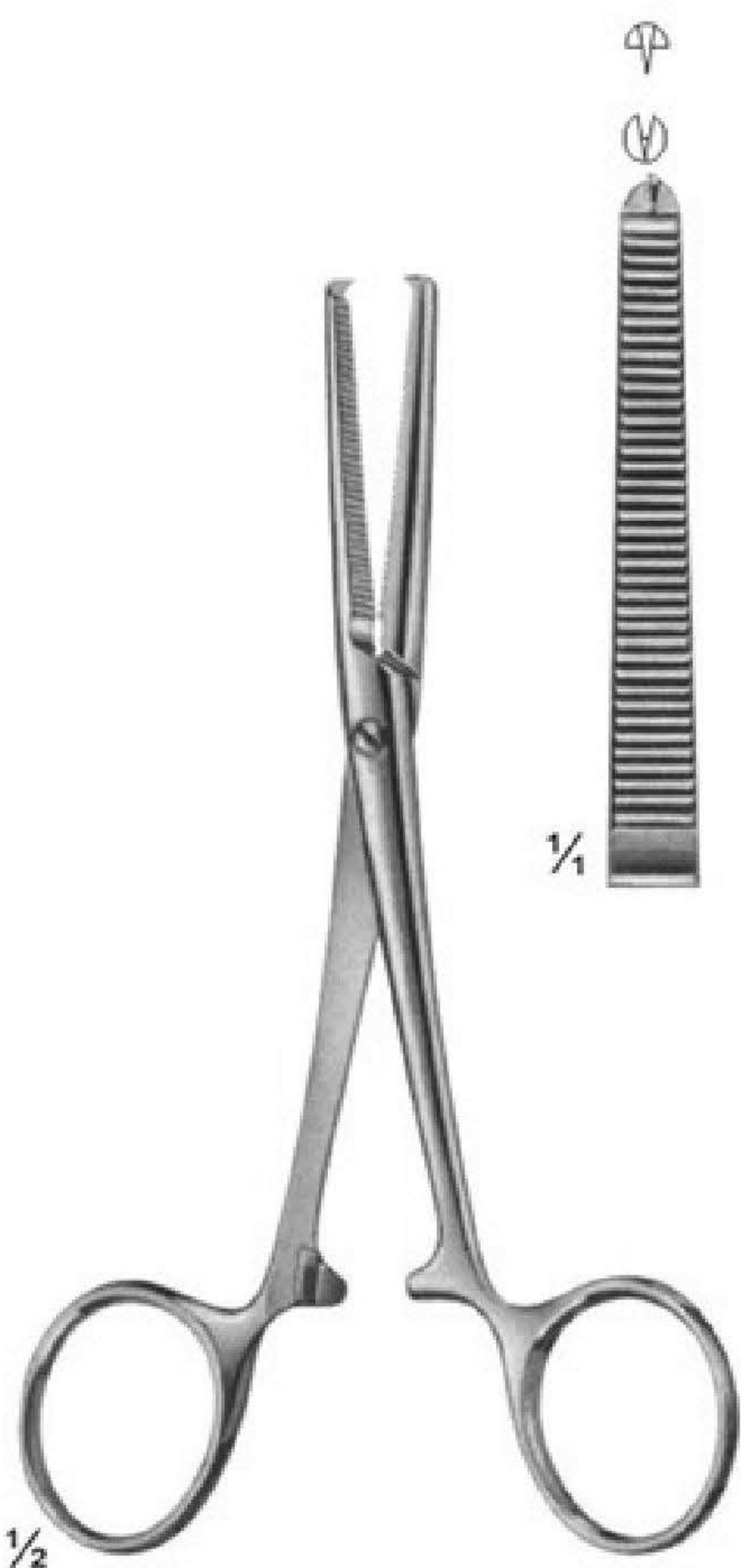
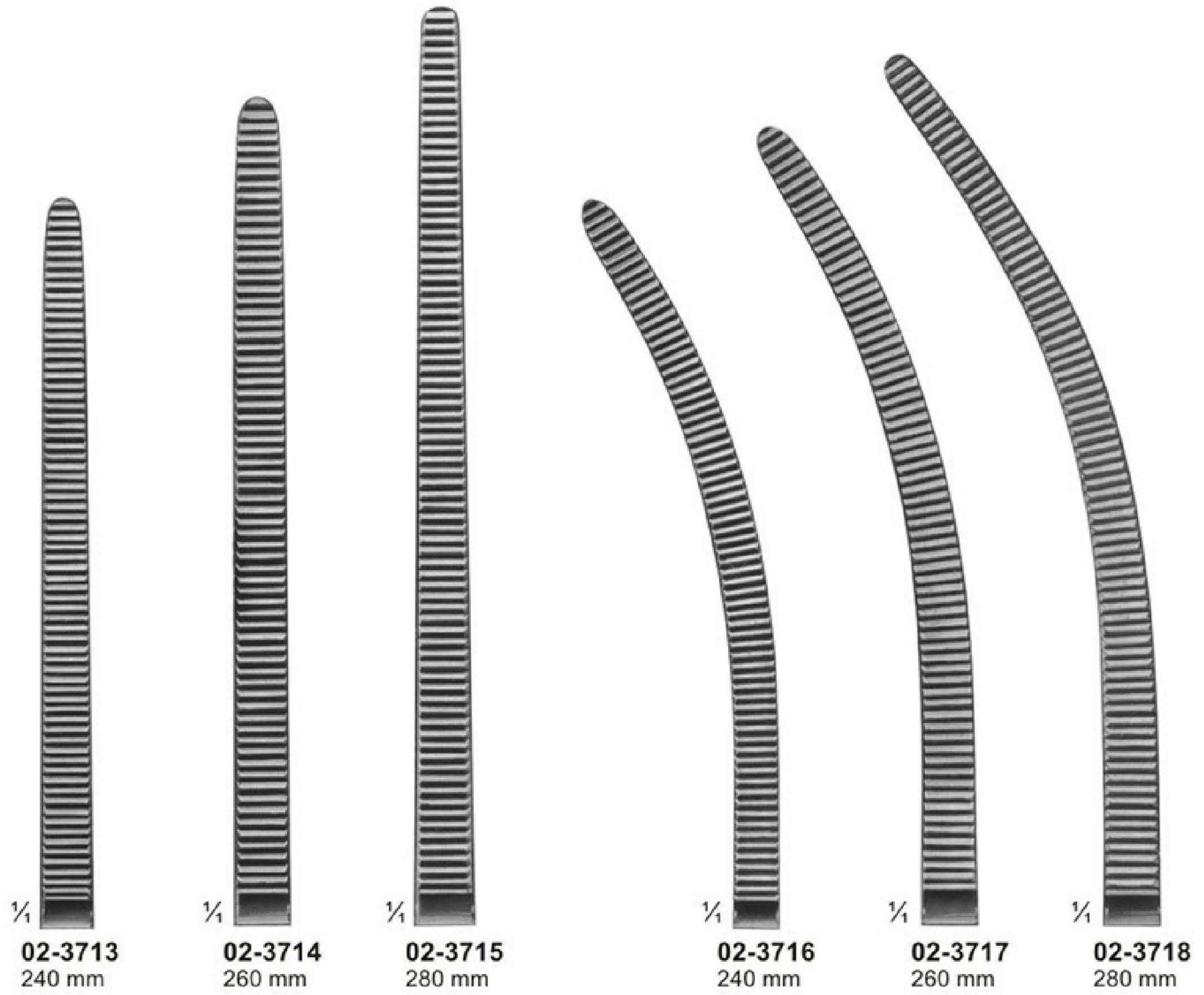

02-3719
KOCHER
Strong Pattern
145 mm

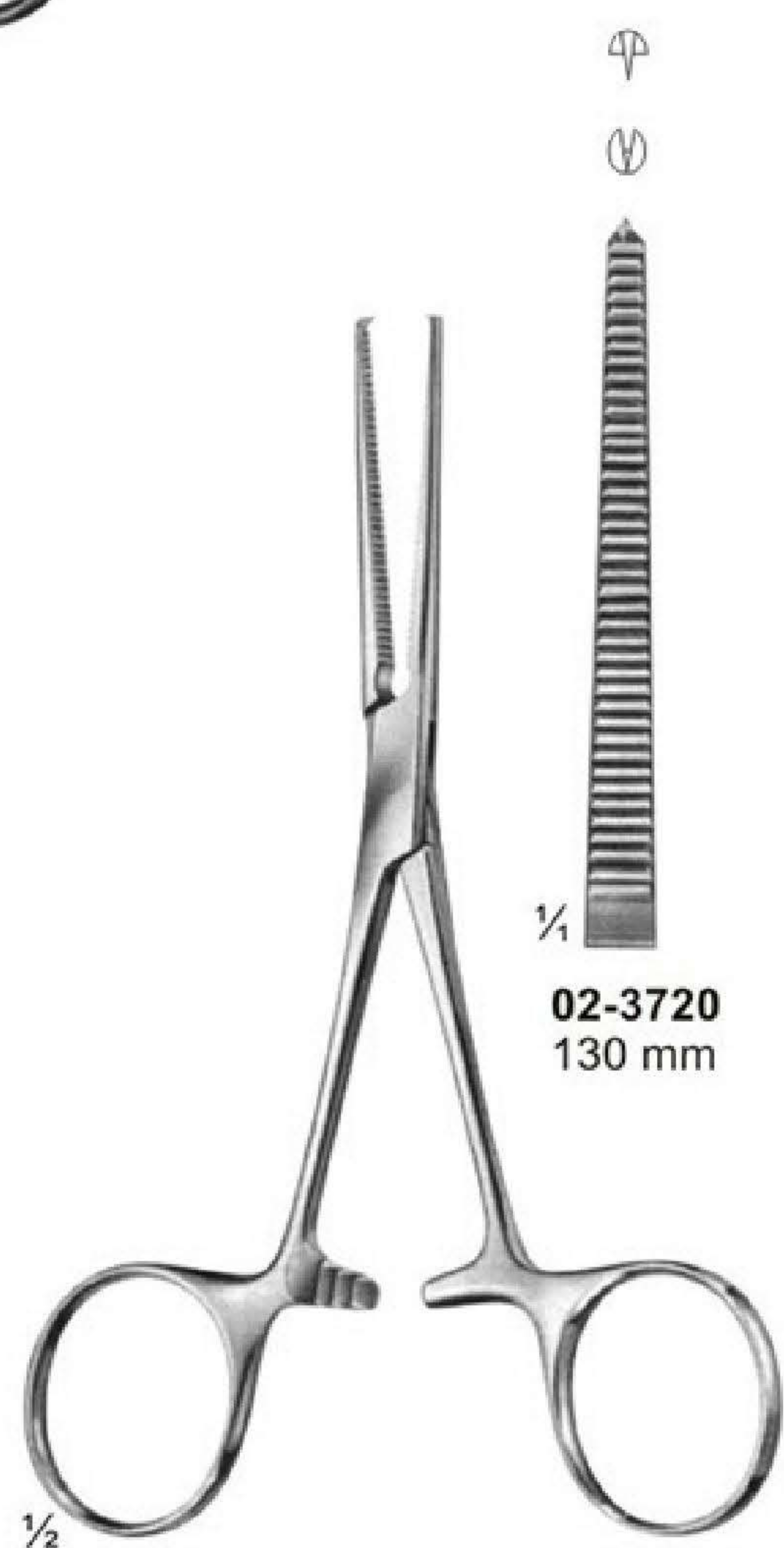

02-3720 - 02-3722
KOCHER

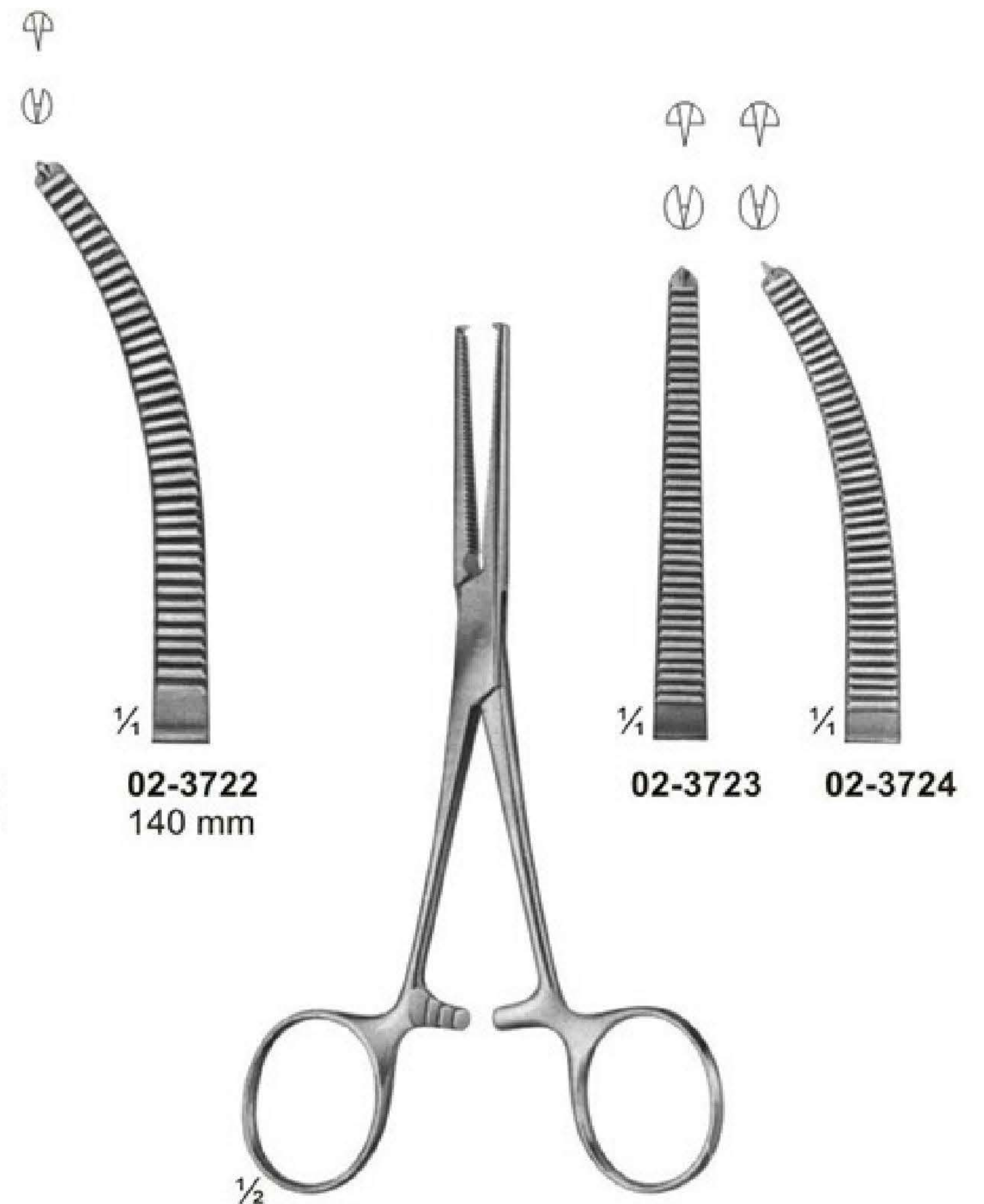

02-3723 - 02-3724
ROCHESTER-OCHSNER
140 mm

Haemostatic Forceps

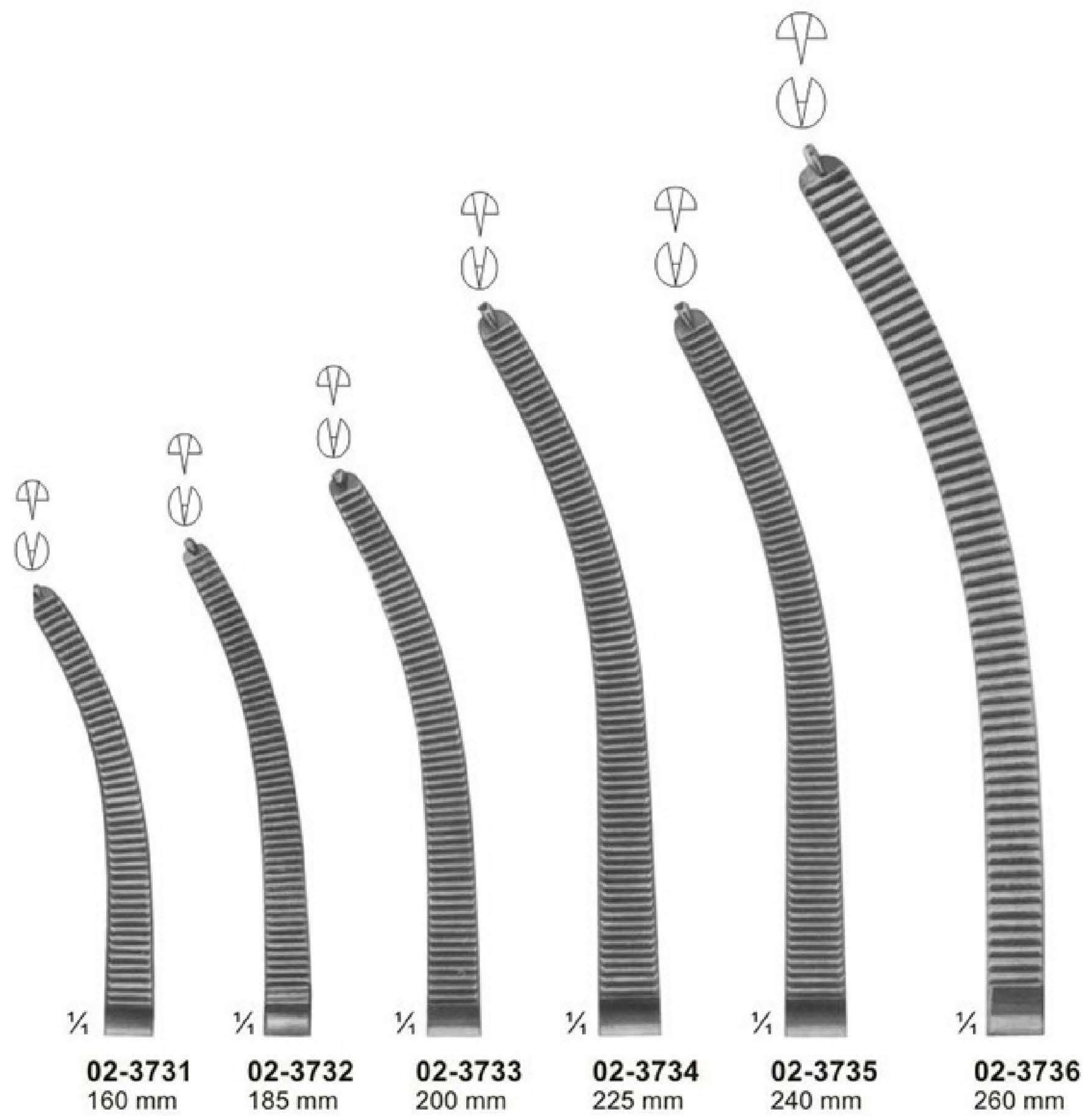
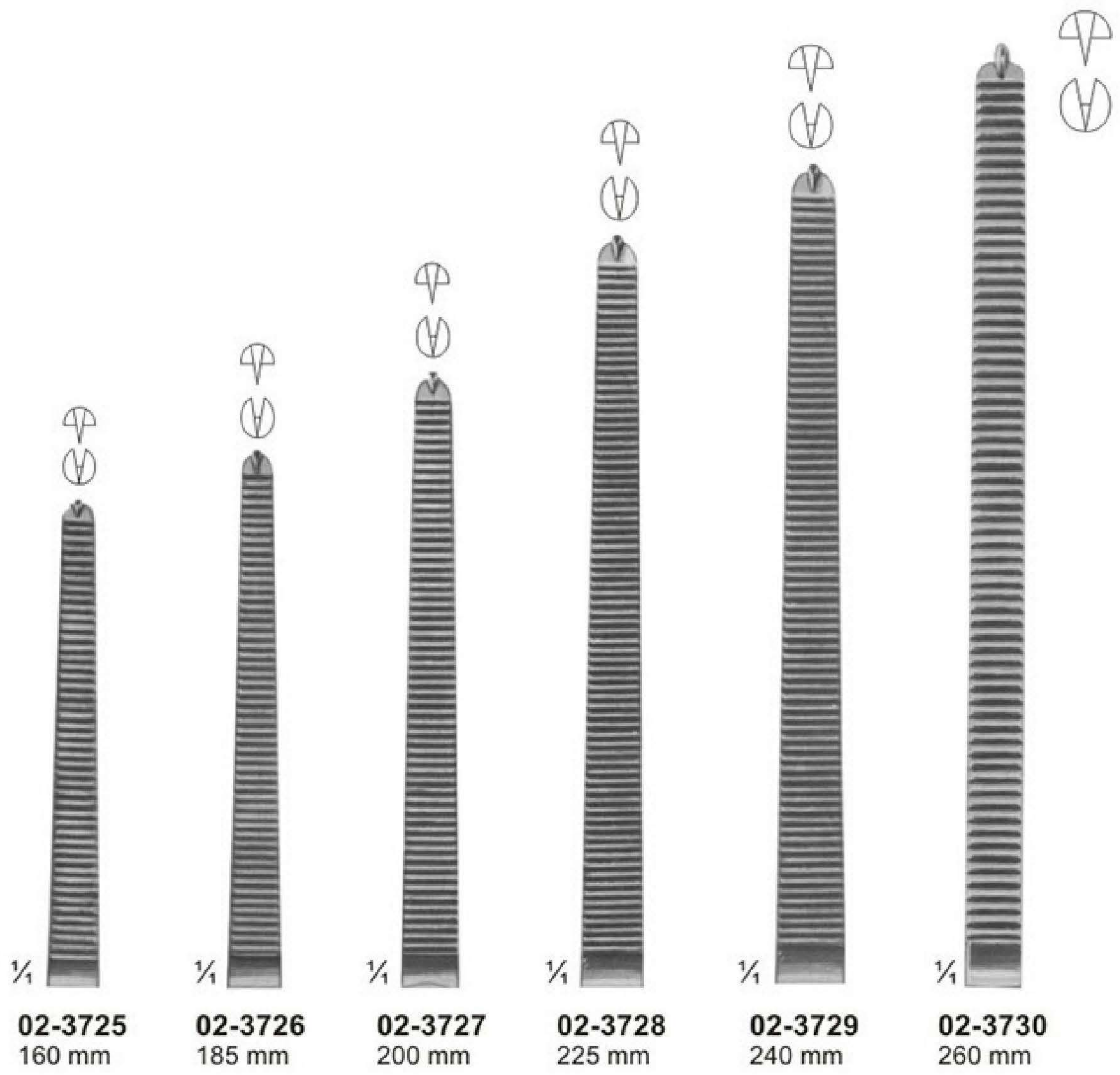

02-3725 - 02-3736
 KOCHER-OCHSNER

Haemostatic Forceps, Special Pattern, Tonsil Forceps

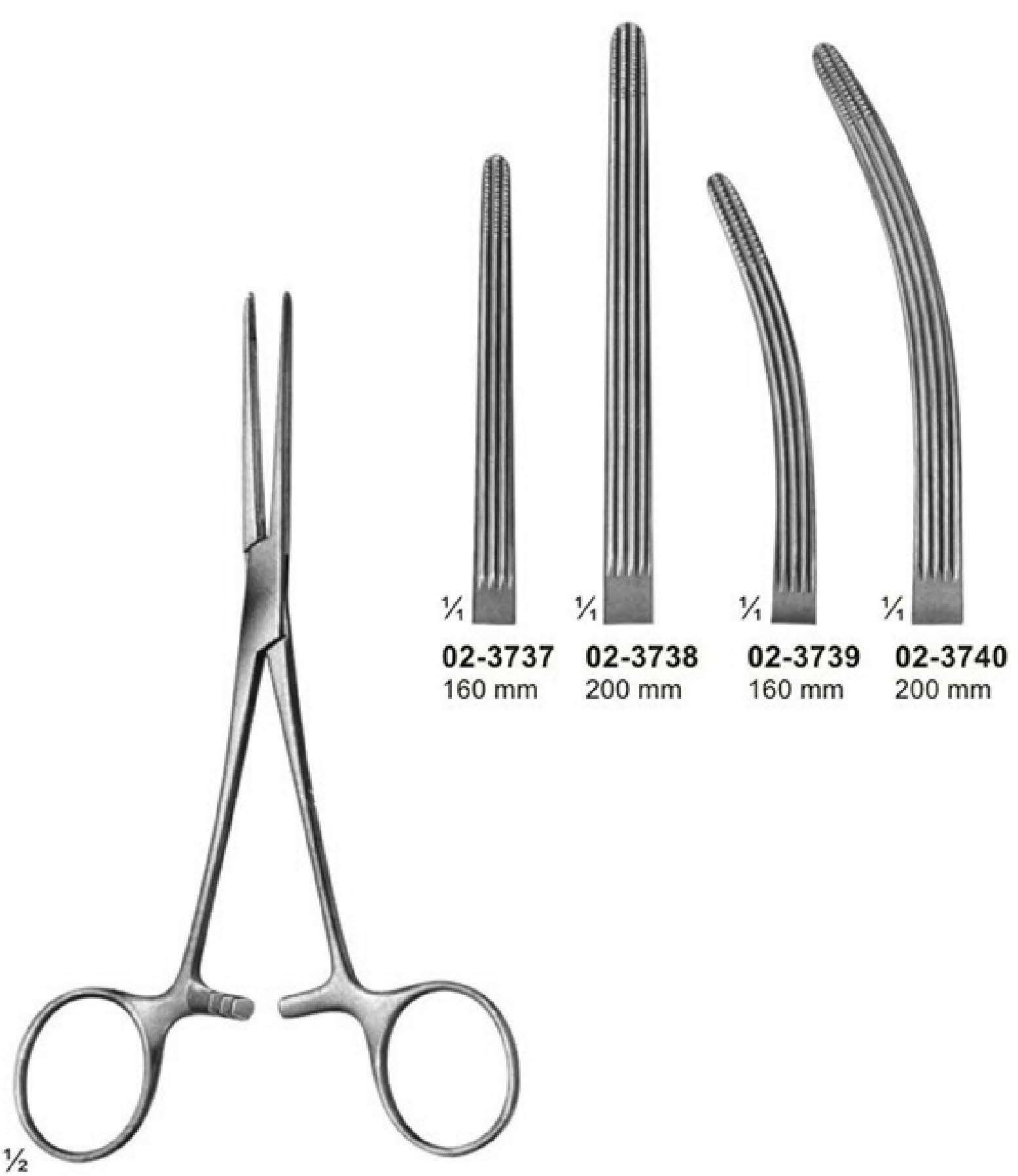

$\frac{1}{4}$ 02-3737 160 mm
 $\frac{1}{4}$ 02-3738 200 mm
 $\frac{1}{4}$ 02-3739 160 mm
 $\frac{1}{4}$ 02-3740 200 mm

02-3737 - 02-3740
ROCHESTER-CARMALT

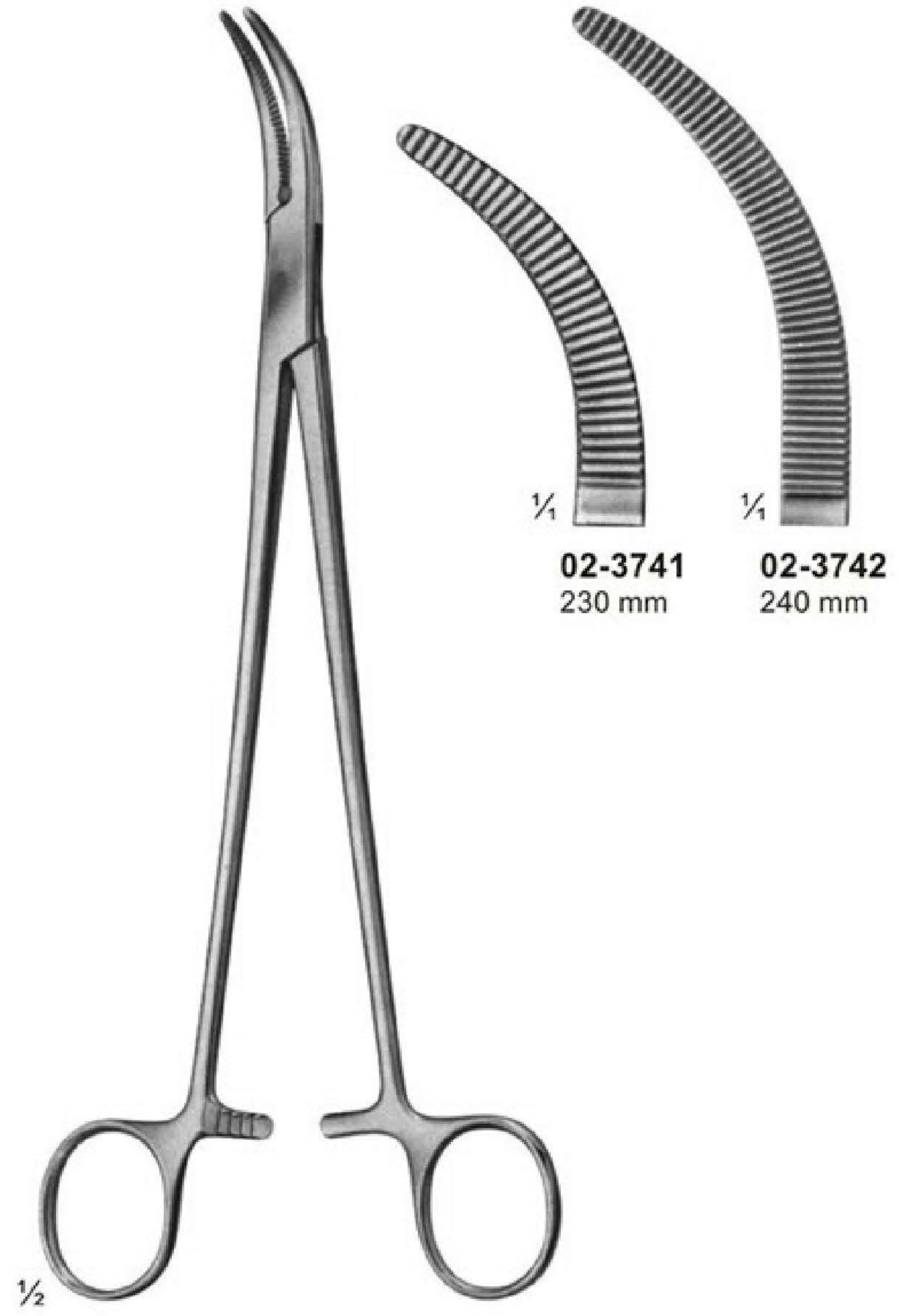

$\frac{1}{4}$ 02-3741 230 mm
 $\frac{1}{4}$ 02-3742 240 mm

02-3741 - 02-3742
MOYNIHAN

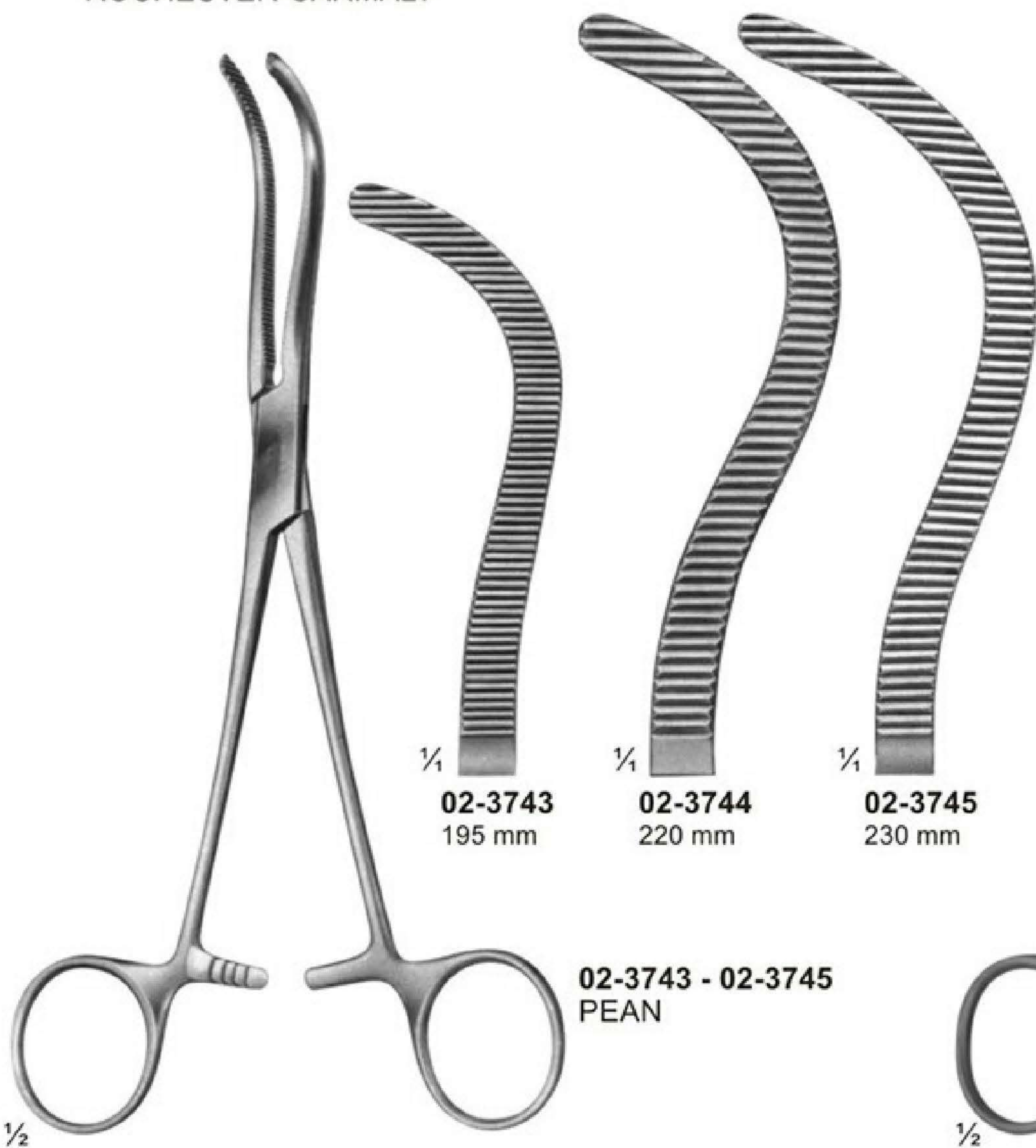

$\frac{1}{4}$ 02-3743 195 mm
 $\frac{1}{4}$ 02-3744 220 mm
 $\frac{1}{4}$ 02-3745 230 mm

02-3743 - 02-3745
PEAN

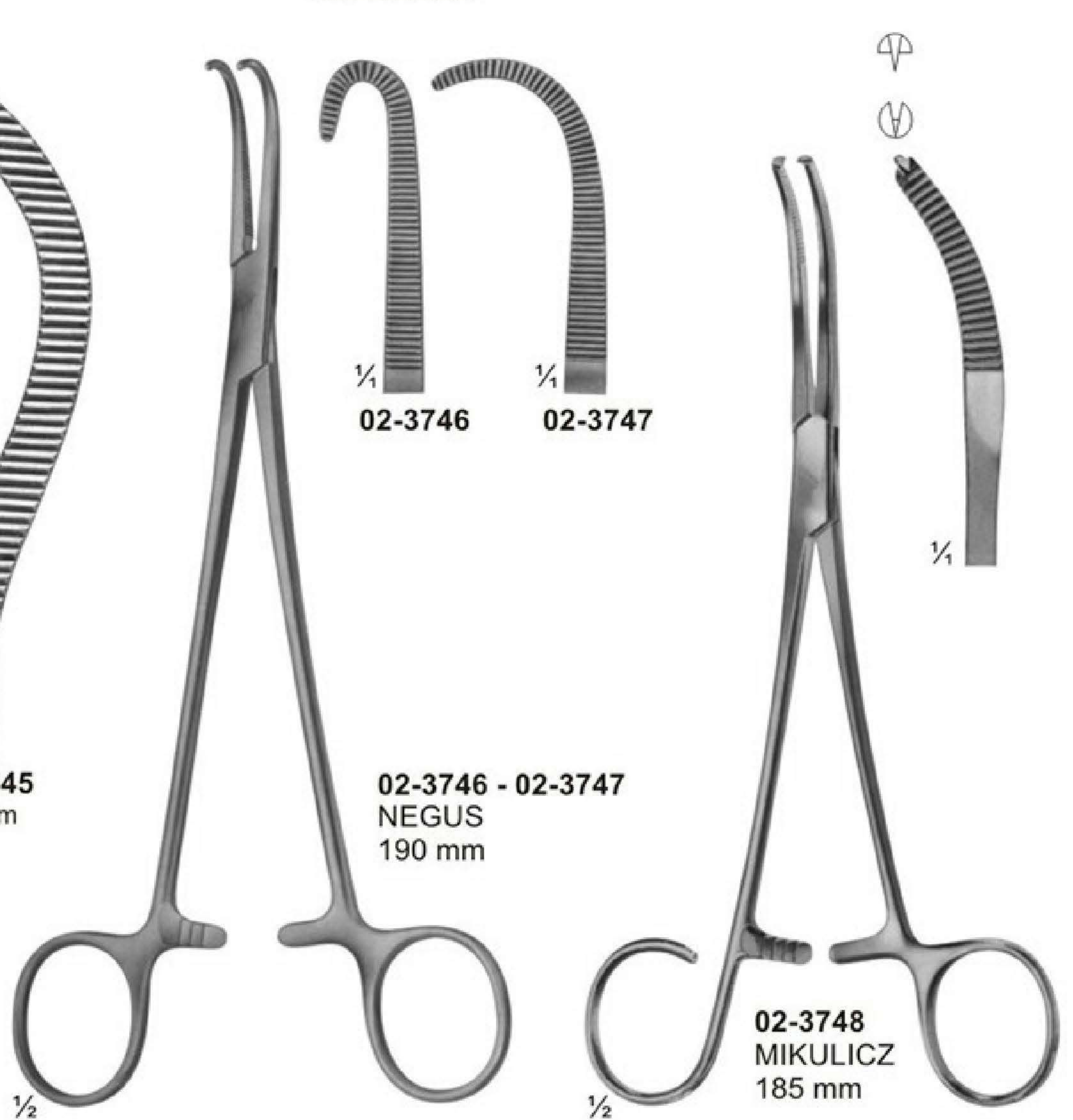

$\frac{1}{4}$ 02-3746
 $\frac{1}{4}$ 02-3747

02-3746 - 02-3747
NEGUS
190 mm

02-3748
MIKULICZ
185 mm

Dissecting- and Ligature Forceps



02-3749
 MICRO-ADSON
 140 mm

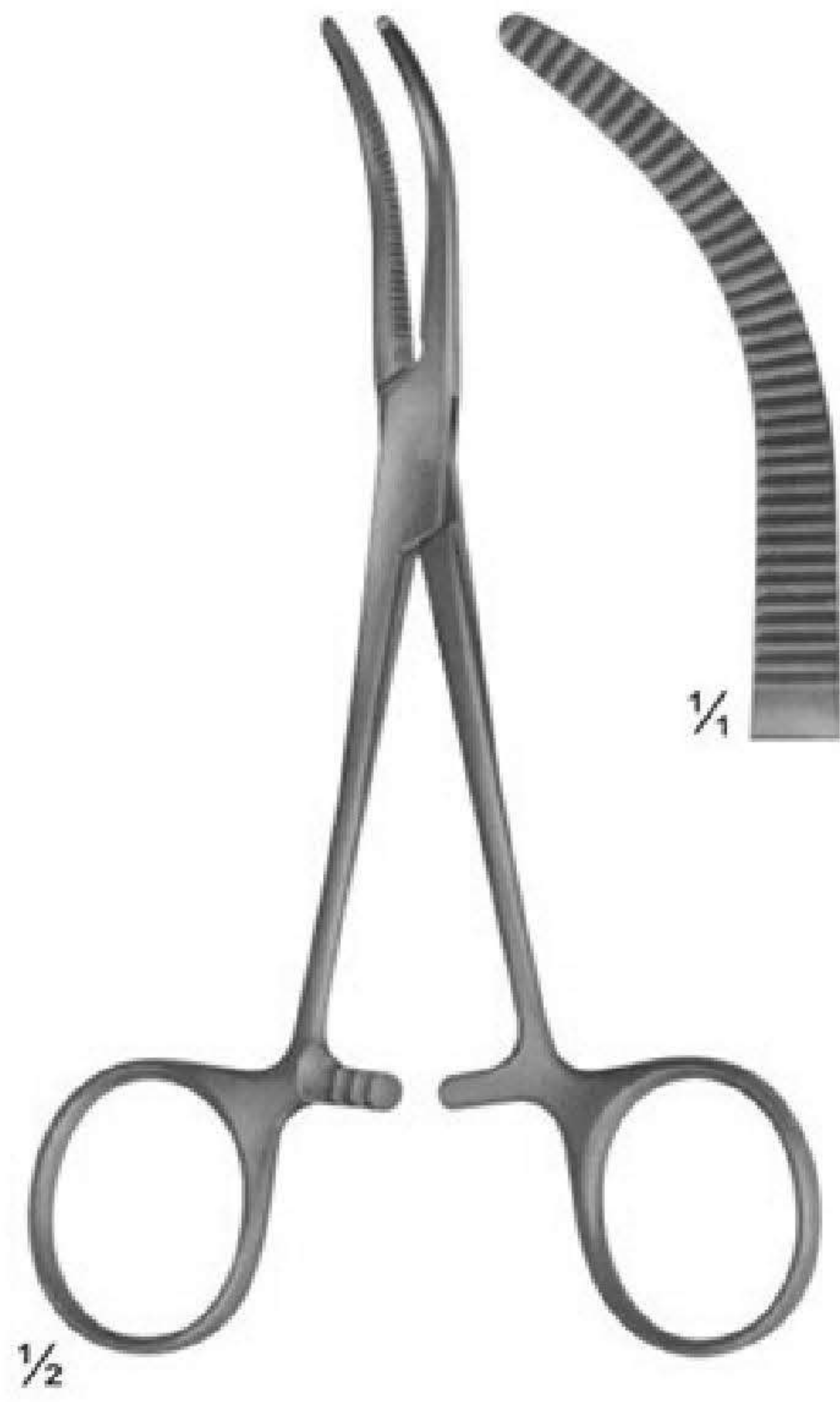

02-3750
 BABY-OVERHOLT
 135 mm



02-3751 - 02-3752
 BABY-MIXTER

02-3751
 140 mm

02-3752
 180 mm

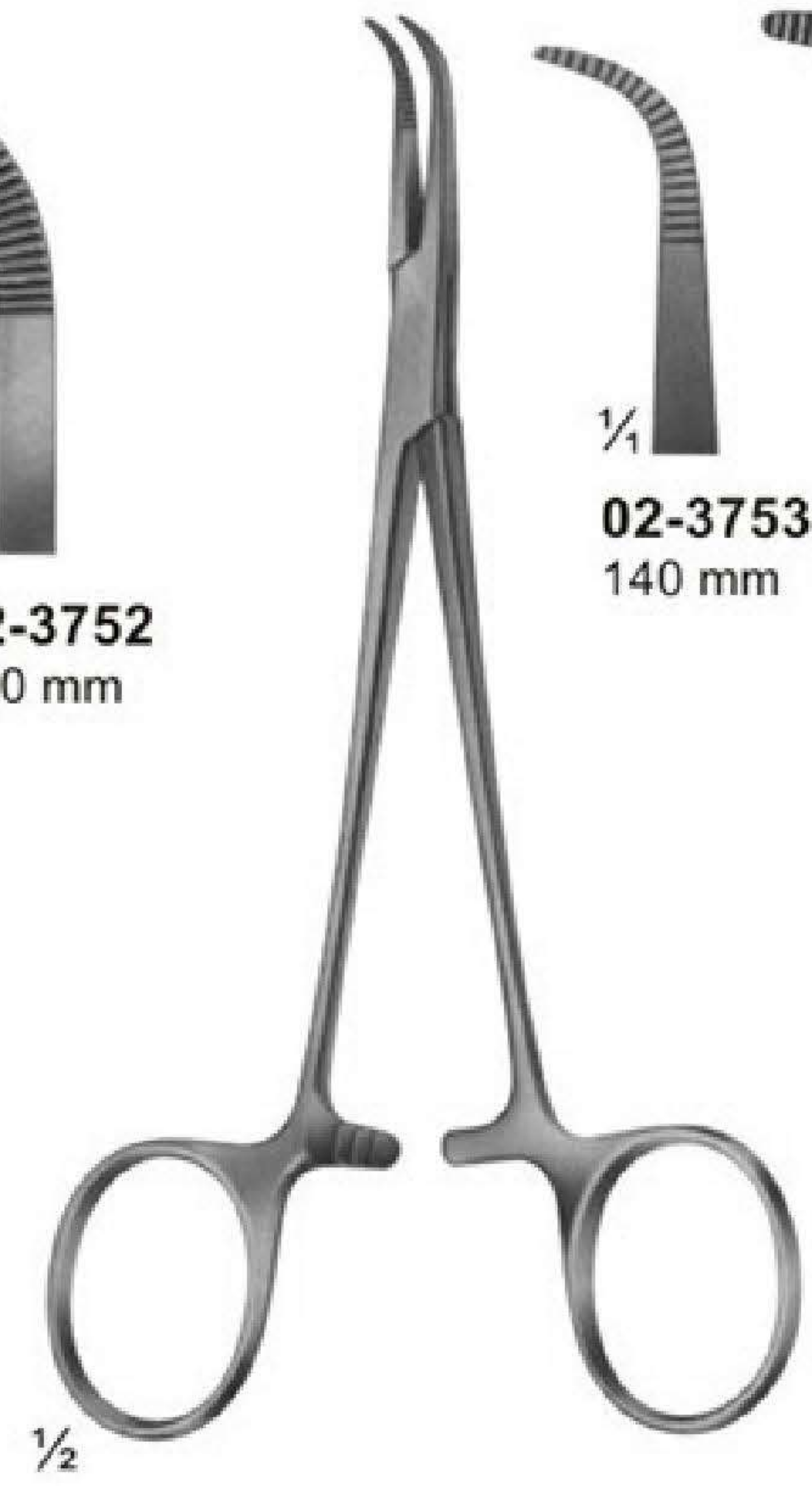

02-3753 - 02-3754
 BABY-ADSON

02-3753
 140 mm

02-3754
 180 mm

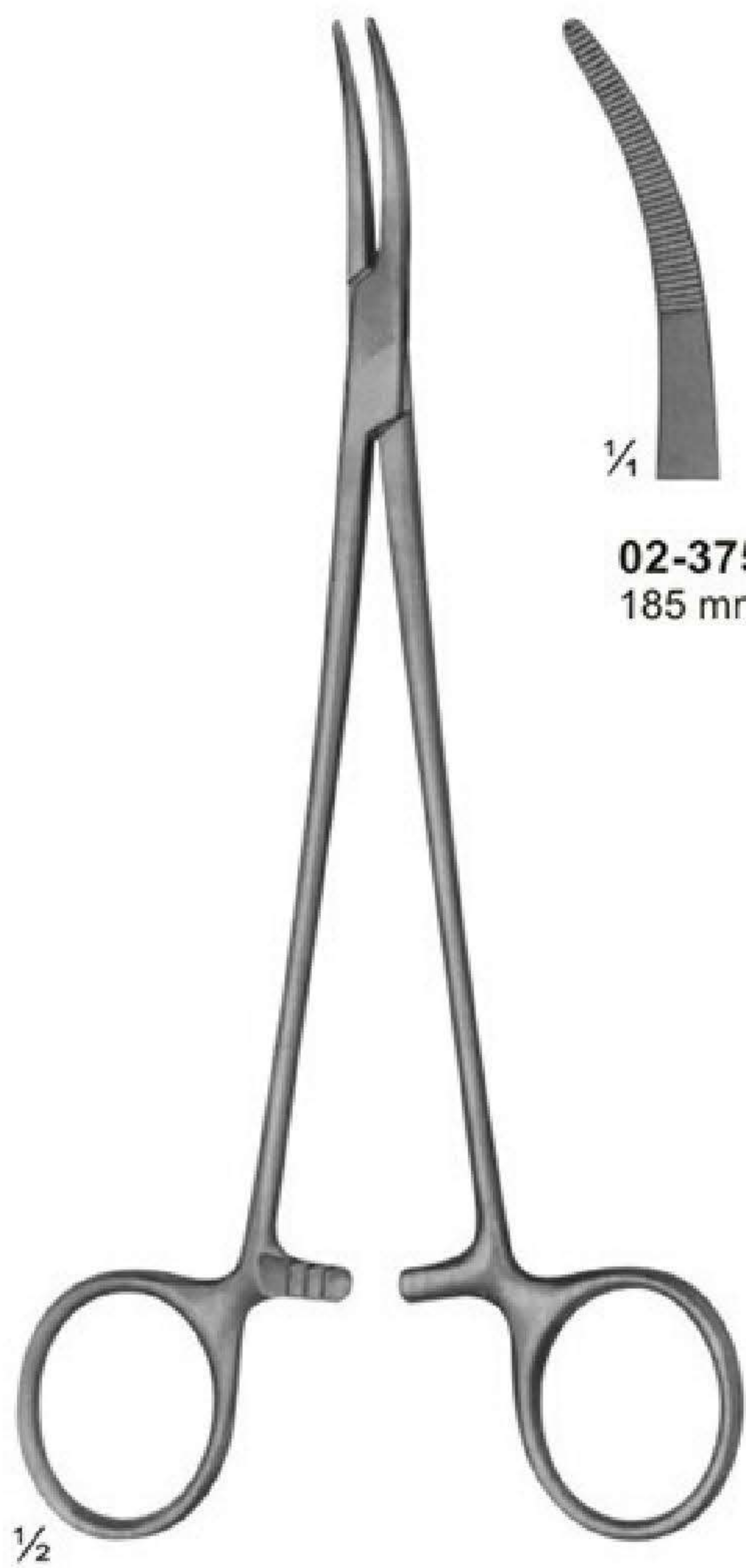

02-3755
 NISSEN

02-3755
 185 mm



02-3756 - 02-3757
 YASARGIL
 195 mm

02-3756

02-3757



02-3758
 OVERHOLT-MIXTER

02-3758
 205 mm

Dissecting- and Ligature Forceps

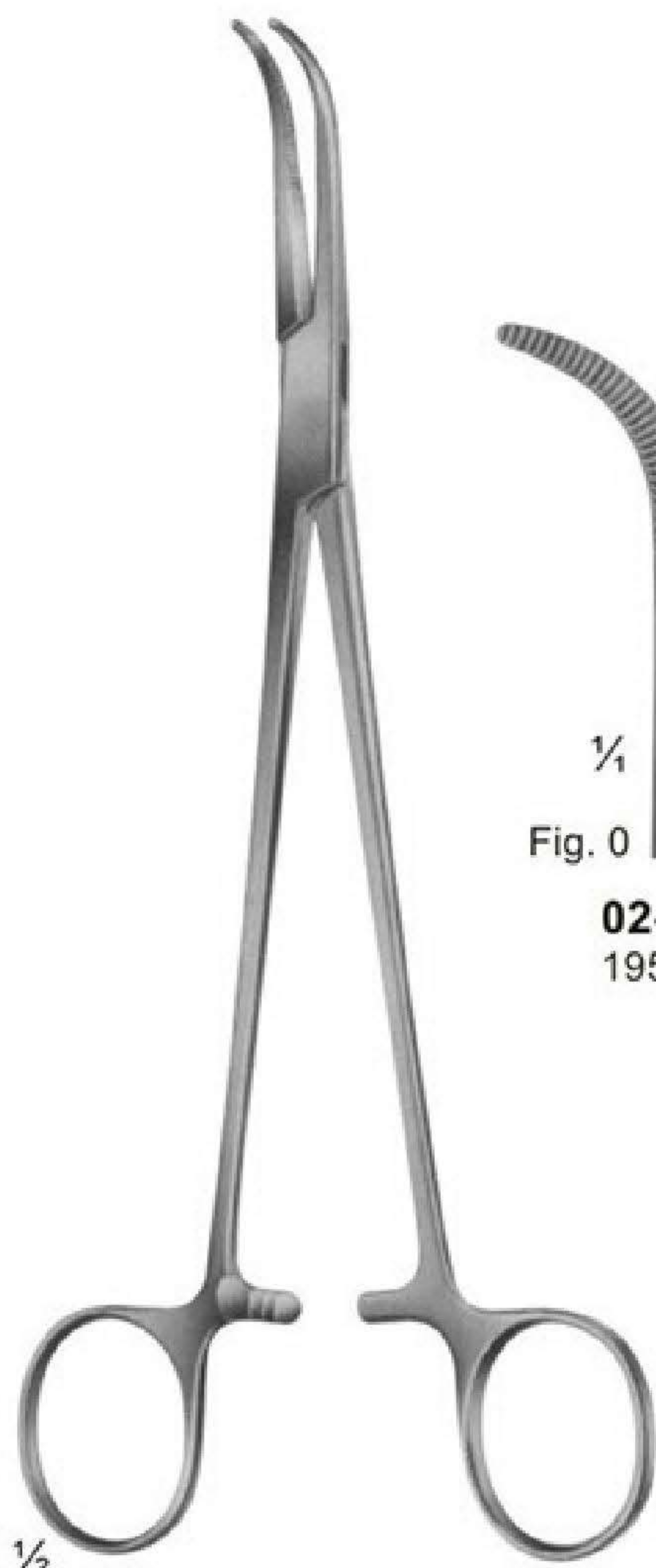

1/2

02-3759 - 02-3770
OVERHOLT-GEISSENDOERFER

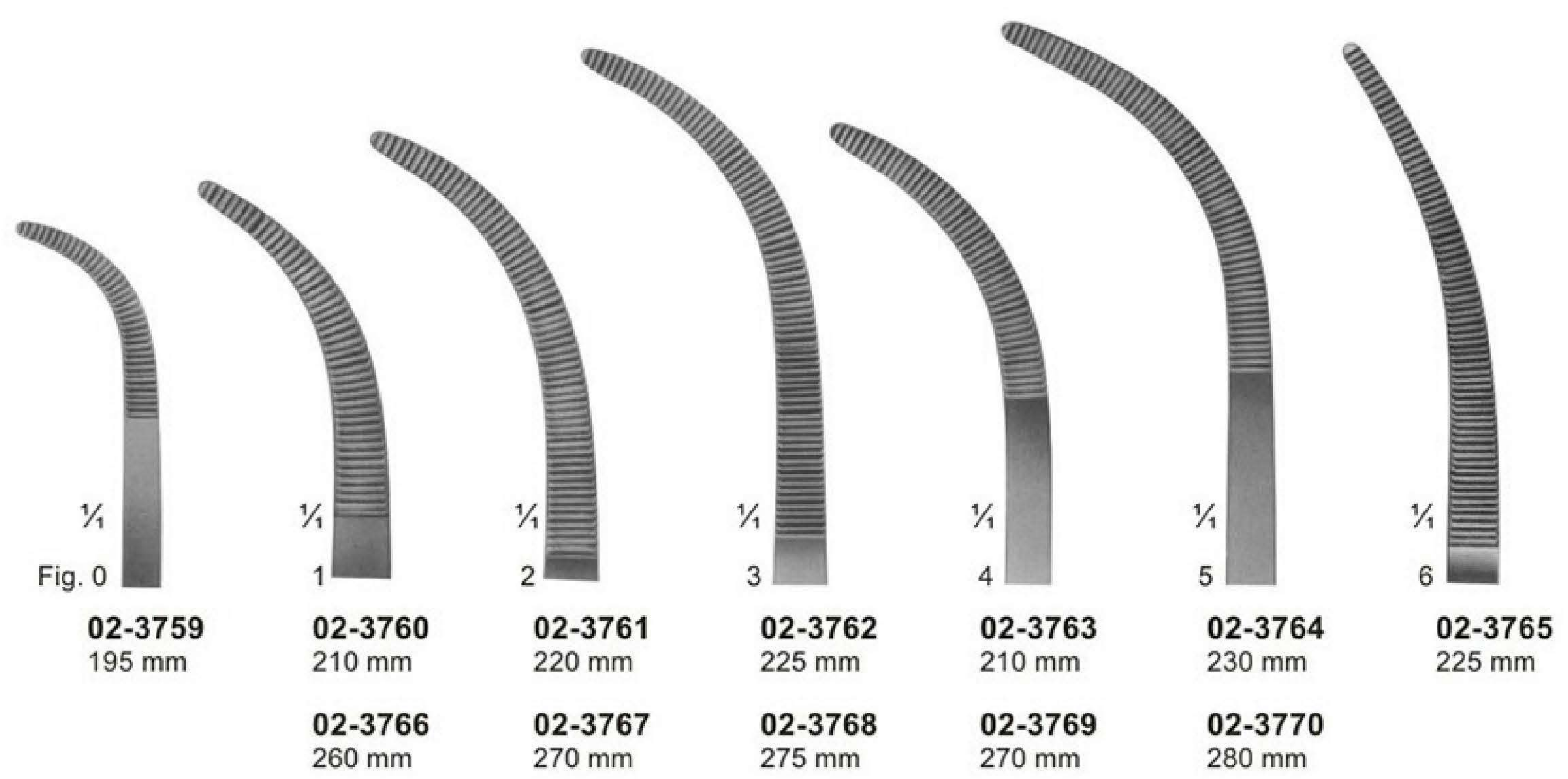

1/2

02-3771 - 02-3778
OVERHOLT
fine pattern

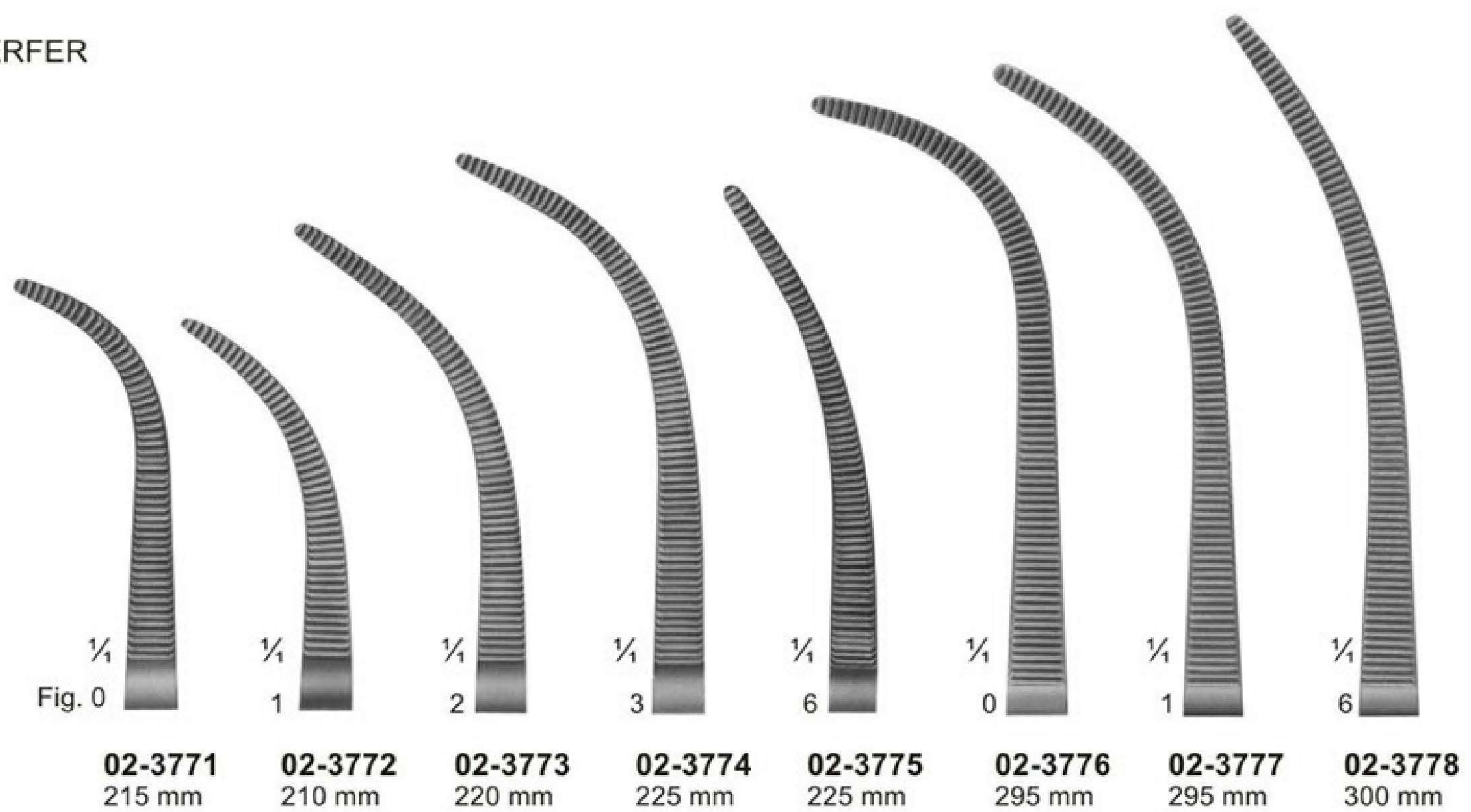

Dissecting- and Ligature Forceps

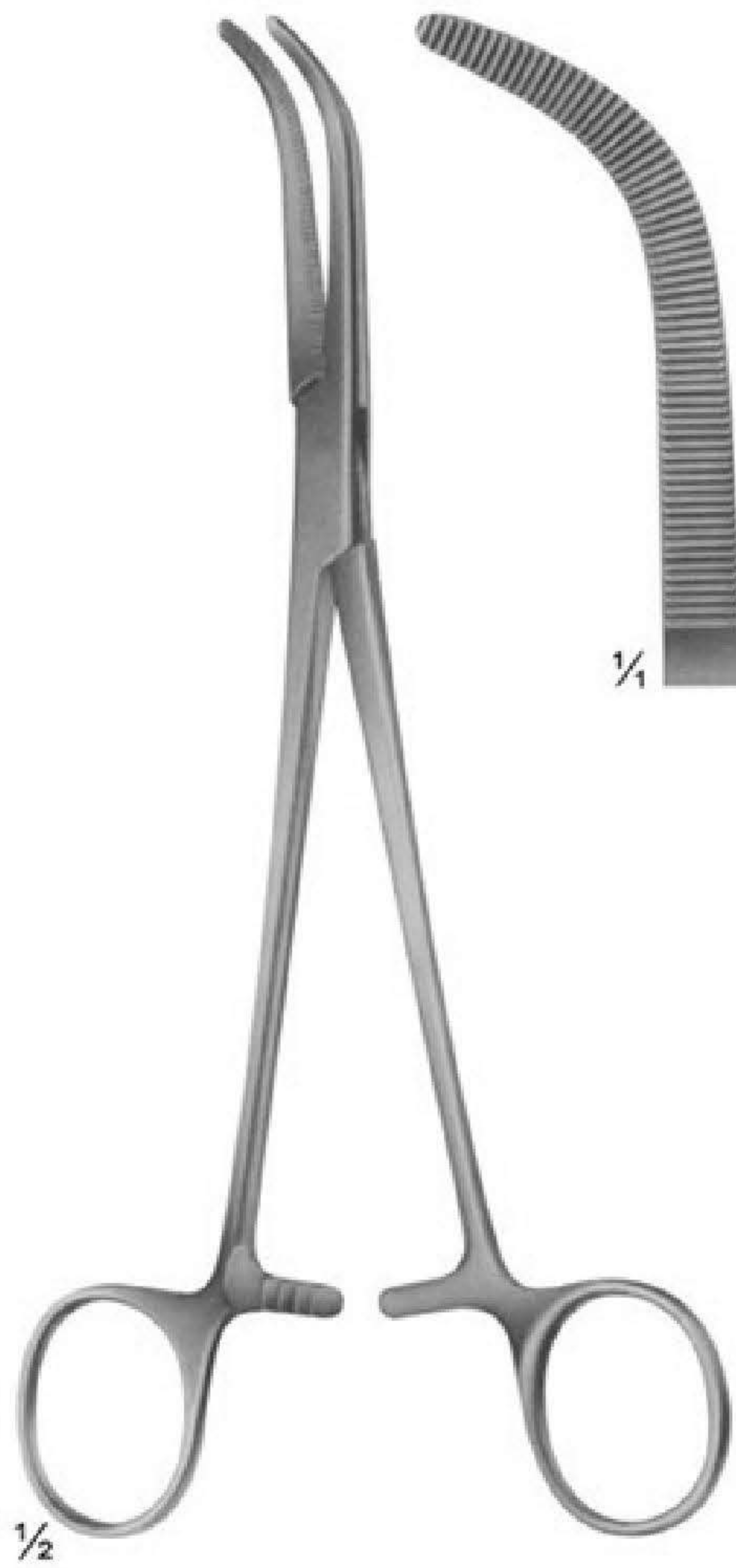

02-3779
 MIXTER-O'SHAUGNESSY
 190 mm

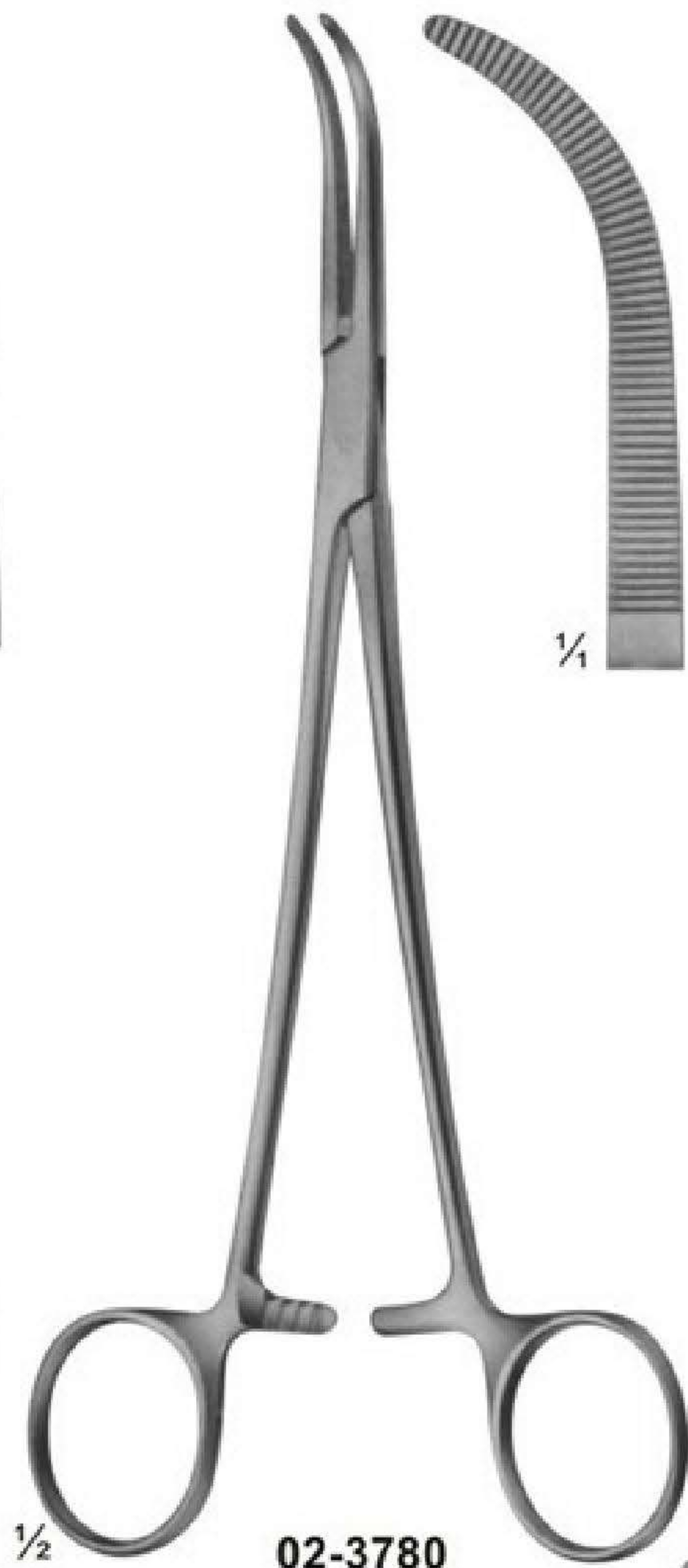

02-3780
 HEISS
 195 mm

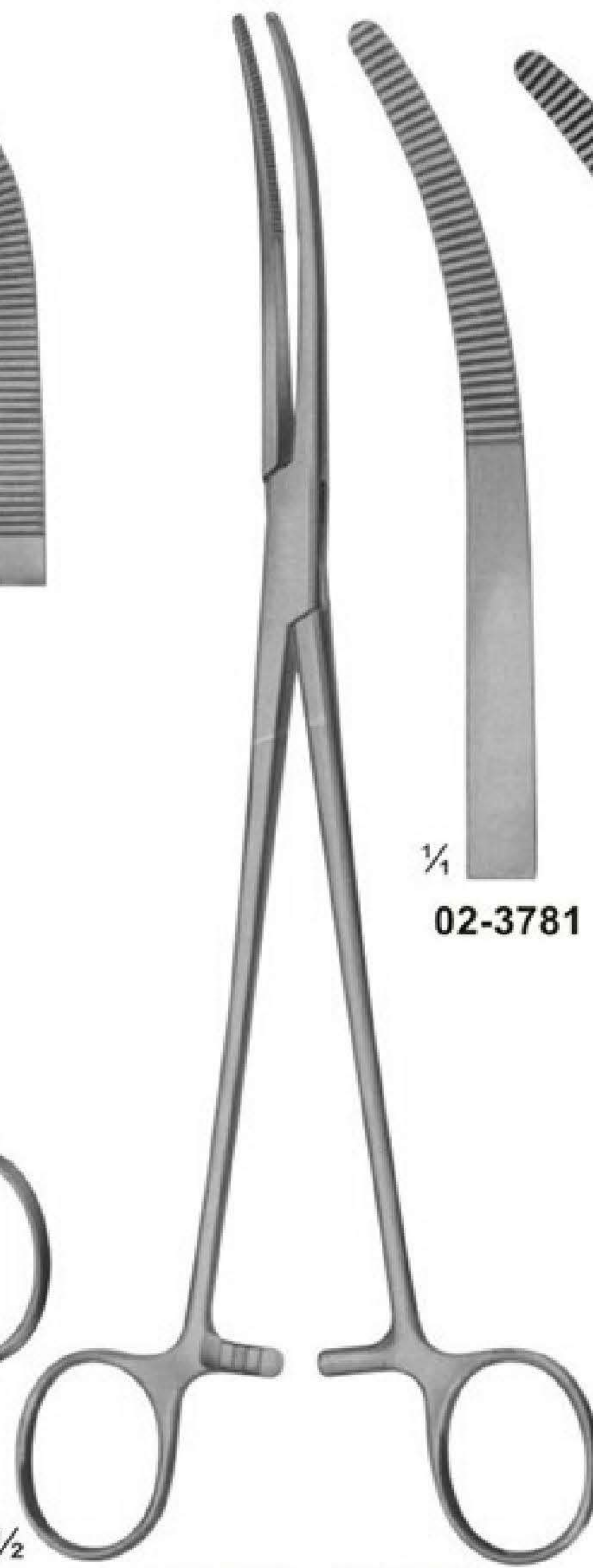

02-3781 - 02-3785
 RUMEL
 240 mm

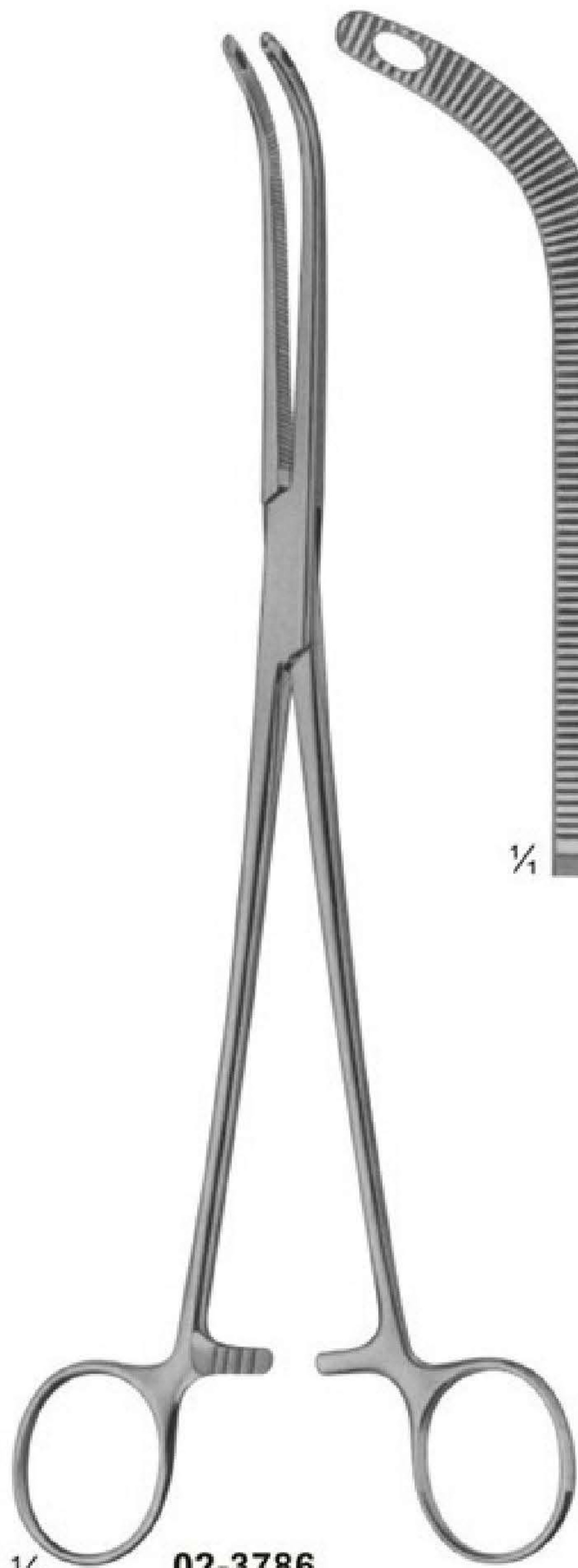
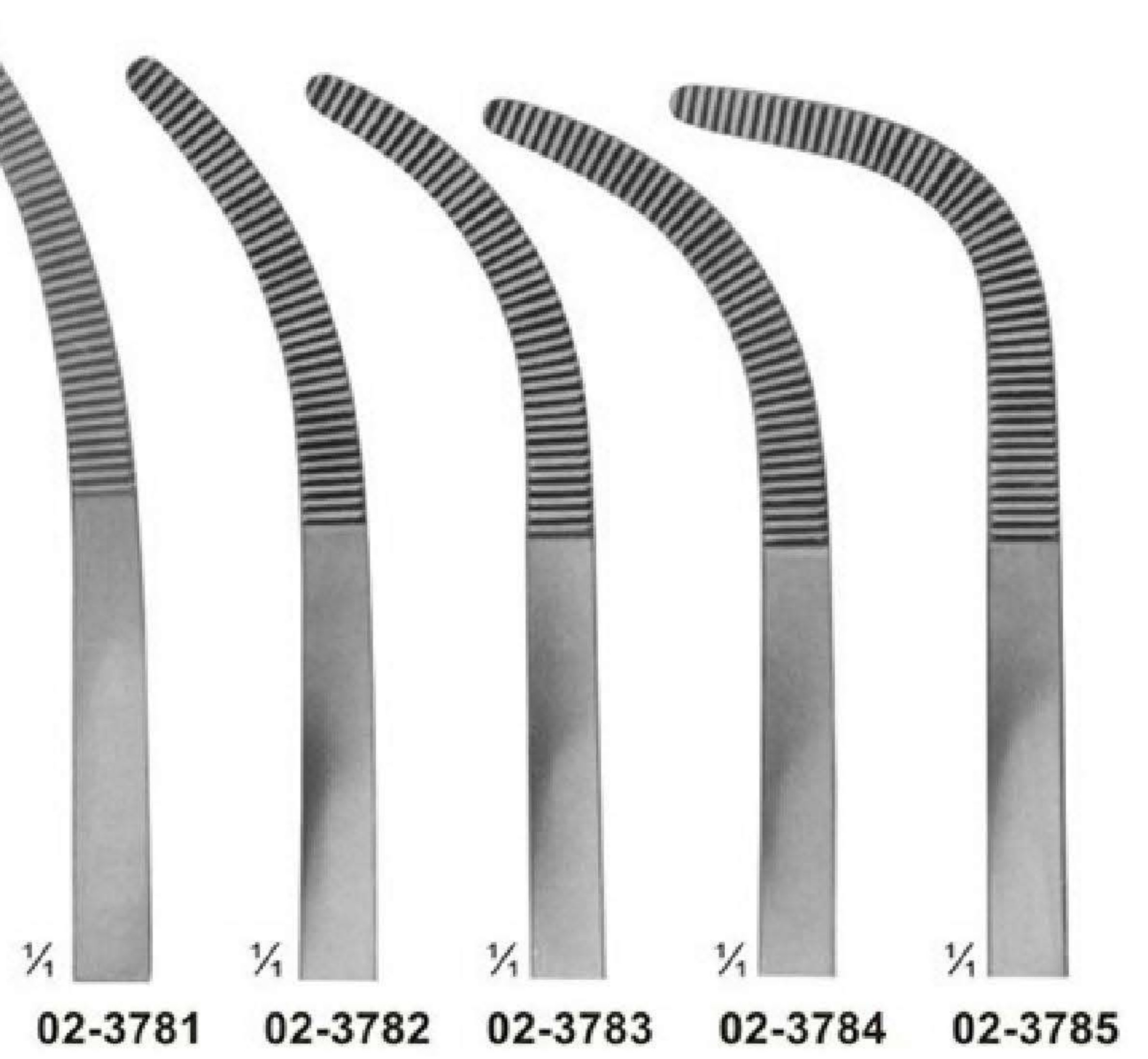

02-3786
 FINOCHIETTO
 245 mm

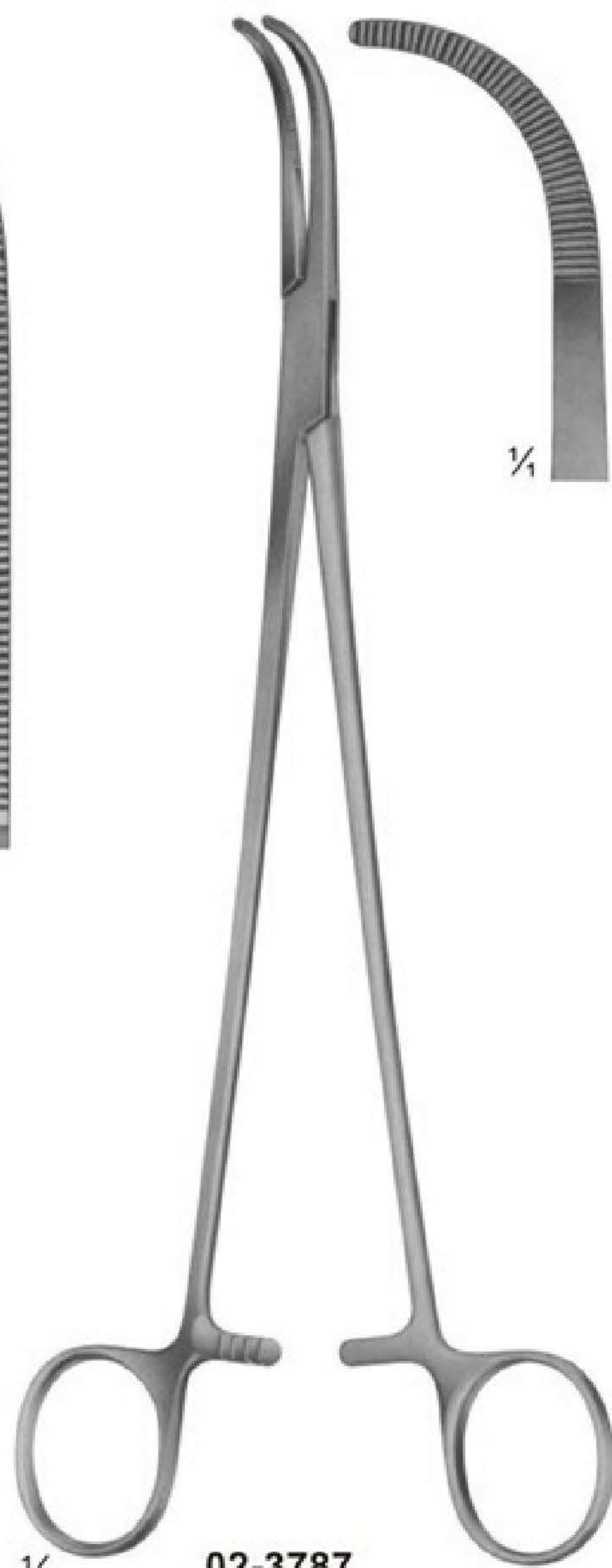

02-3787
 MIXTER
 230 mm



02-3788
 LAWRENCE
 270 mm

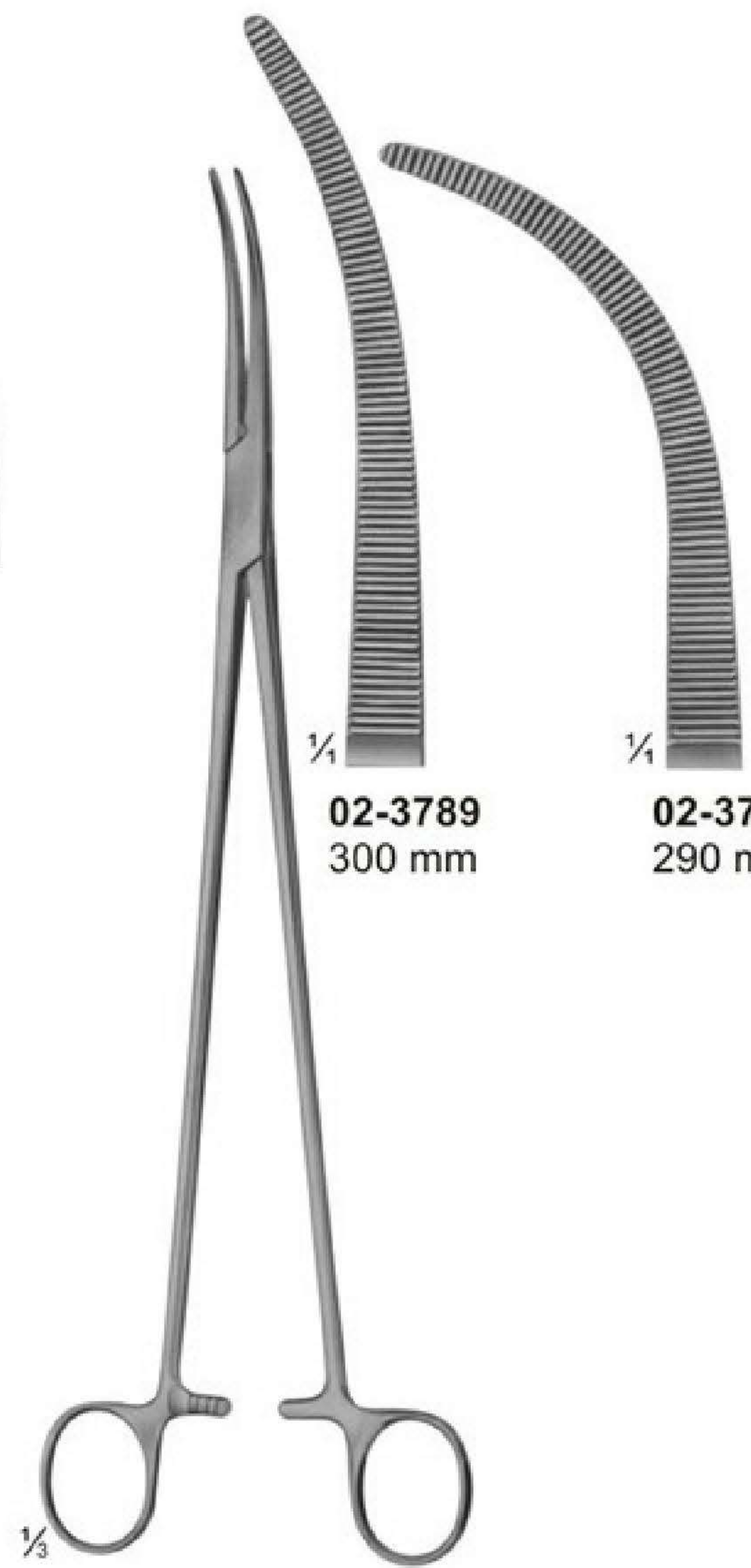

02-3789 - 02-3790
 ZENKER

Dissecting- and Ligature Forceps

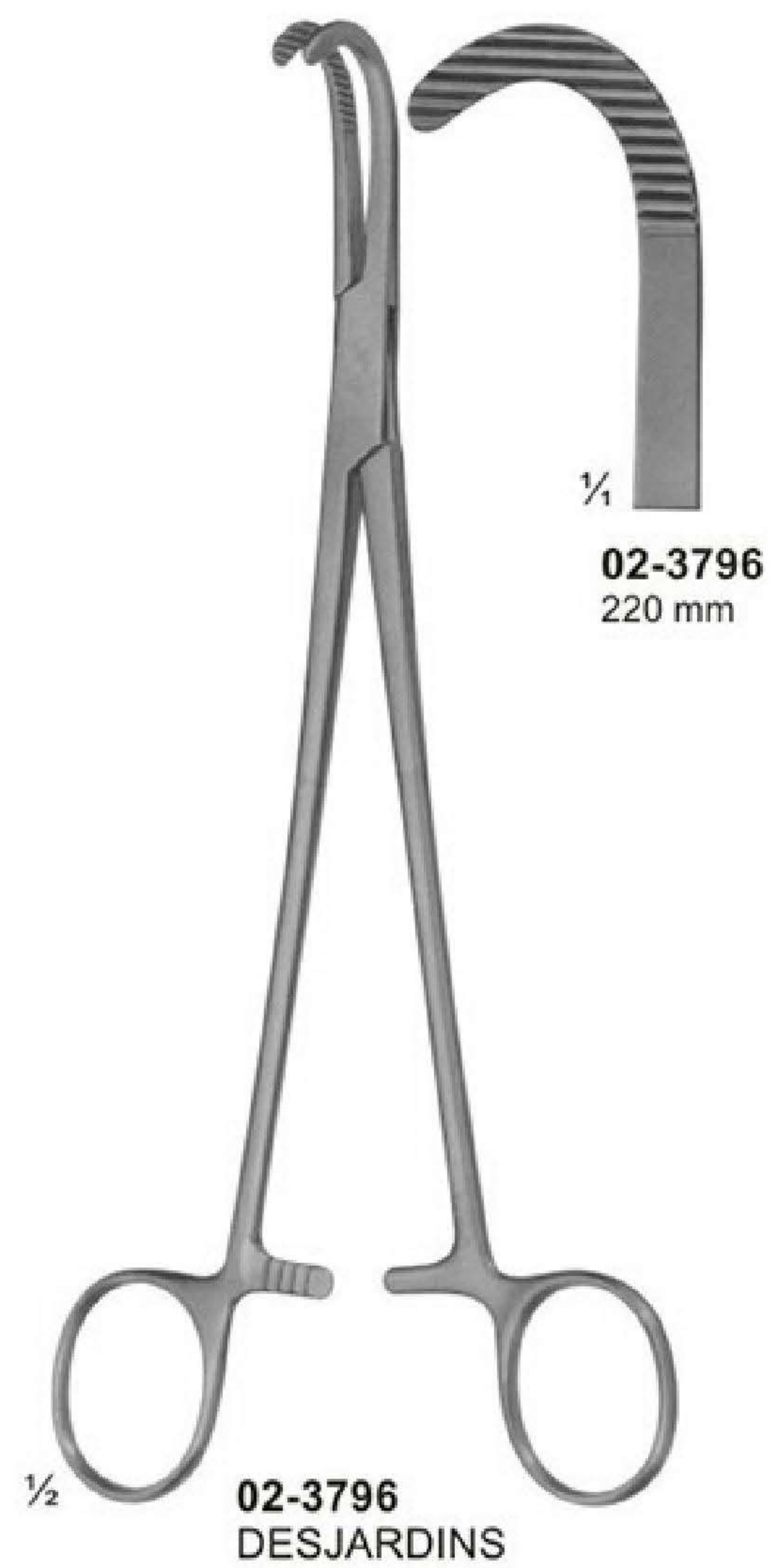

Peritoneum Forceps

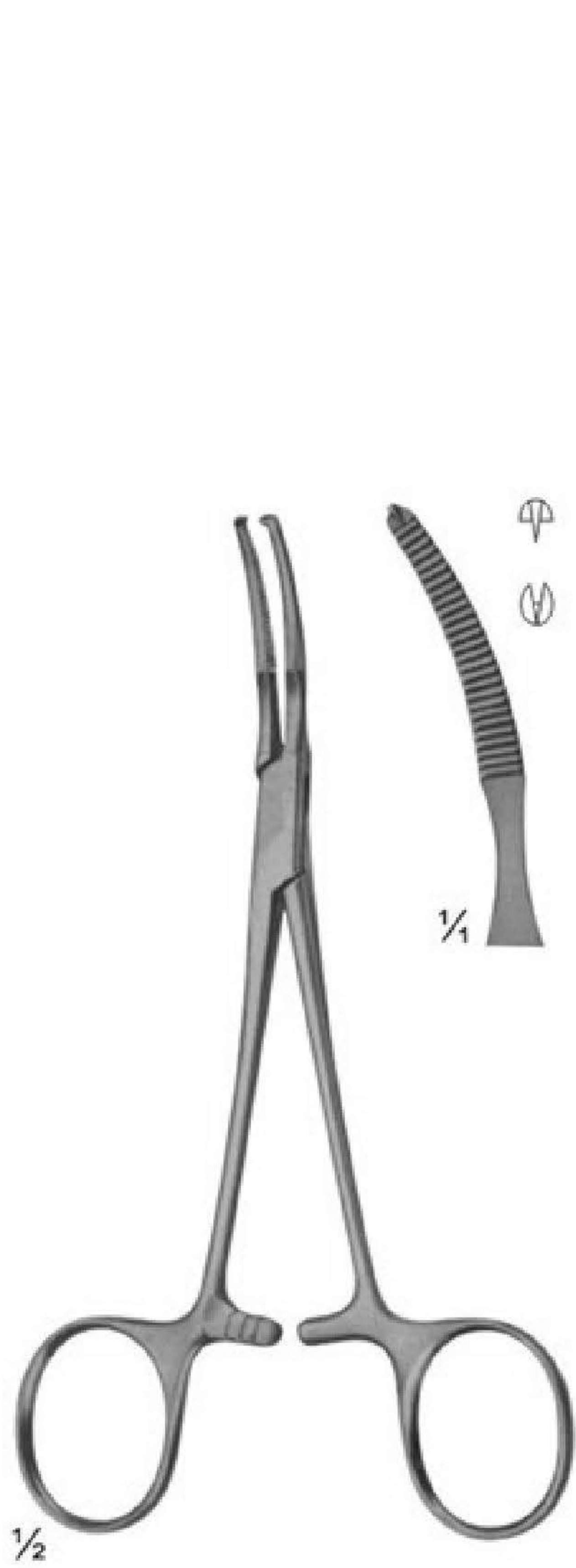

02-3799
BABY-MIKULICZ
140 mm

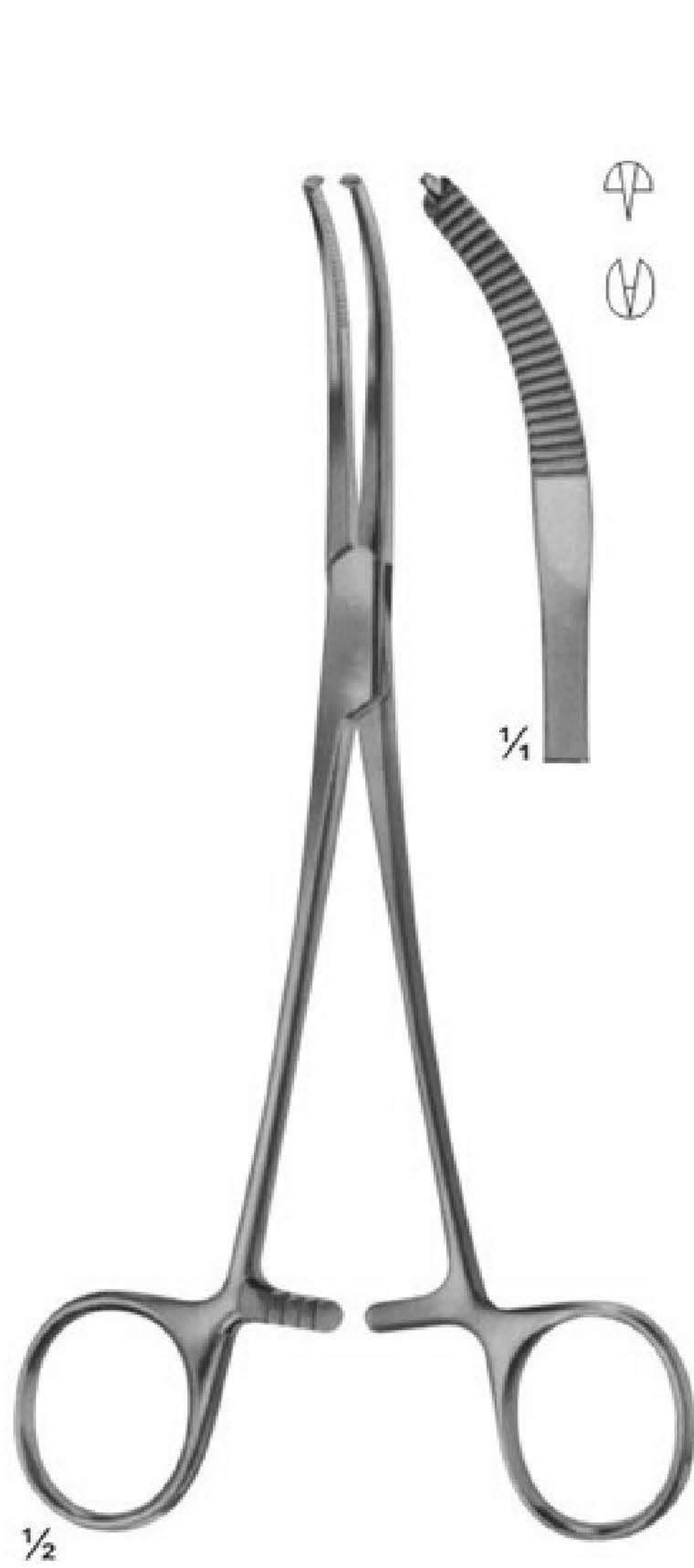

02-3800
MIKULICZ
185 mm

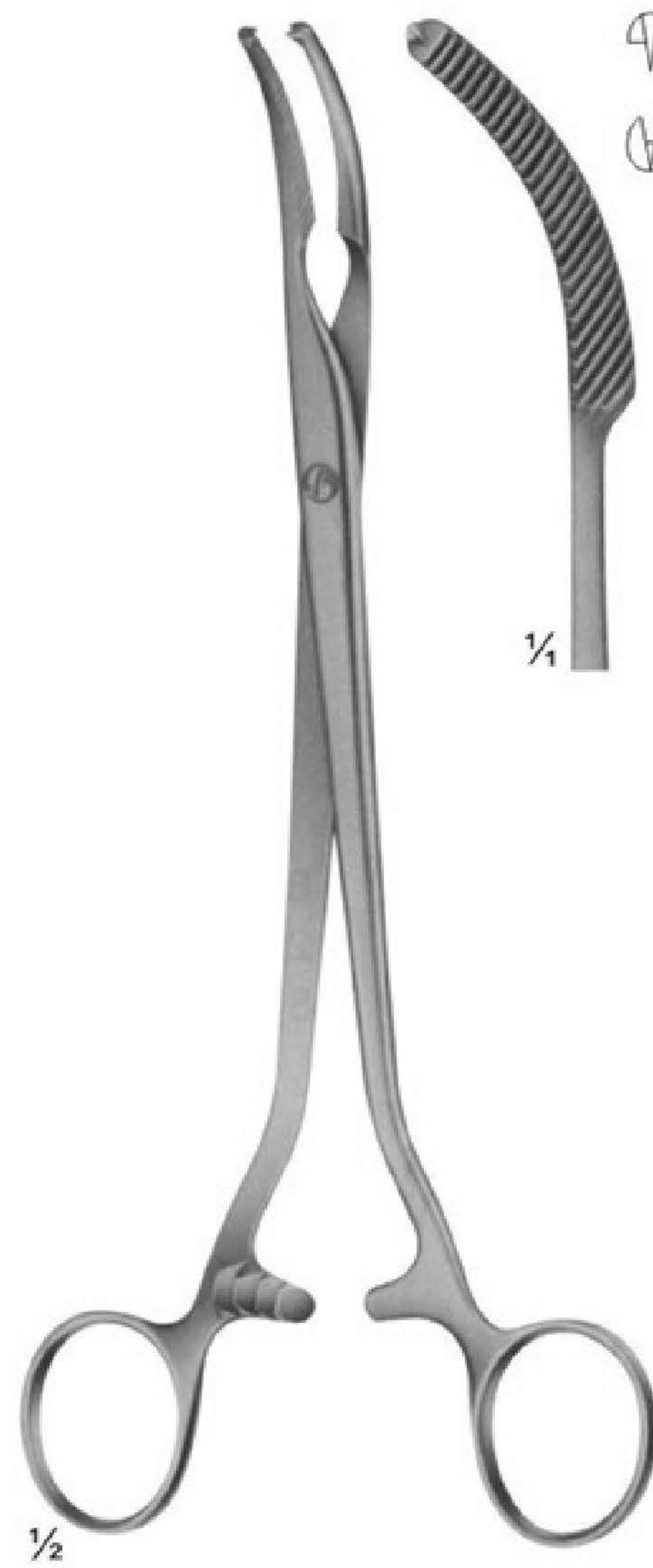

02-3801
MIKULICZ
205 mm

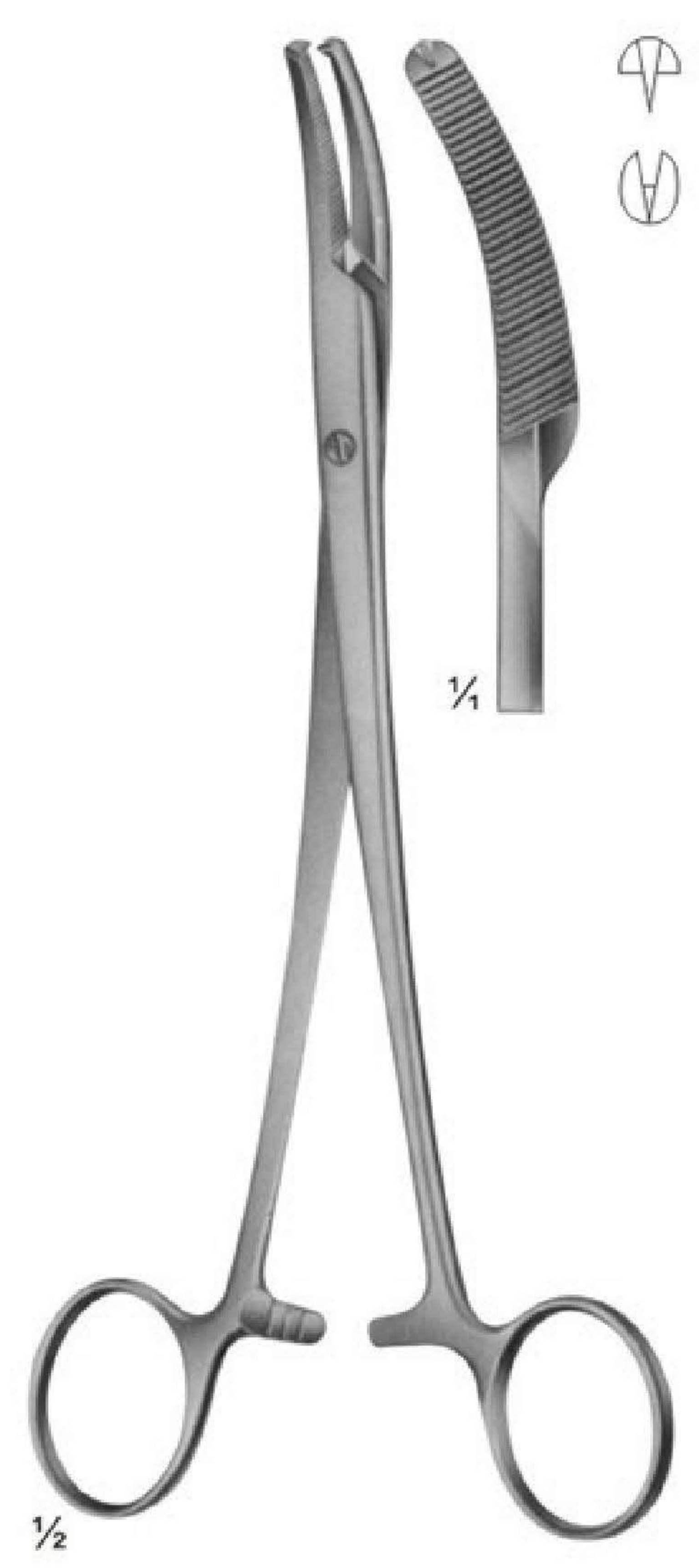

02-3802
MIKULICZ
200 mm

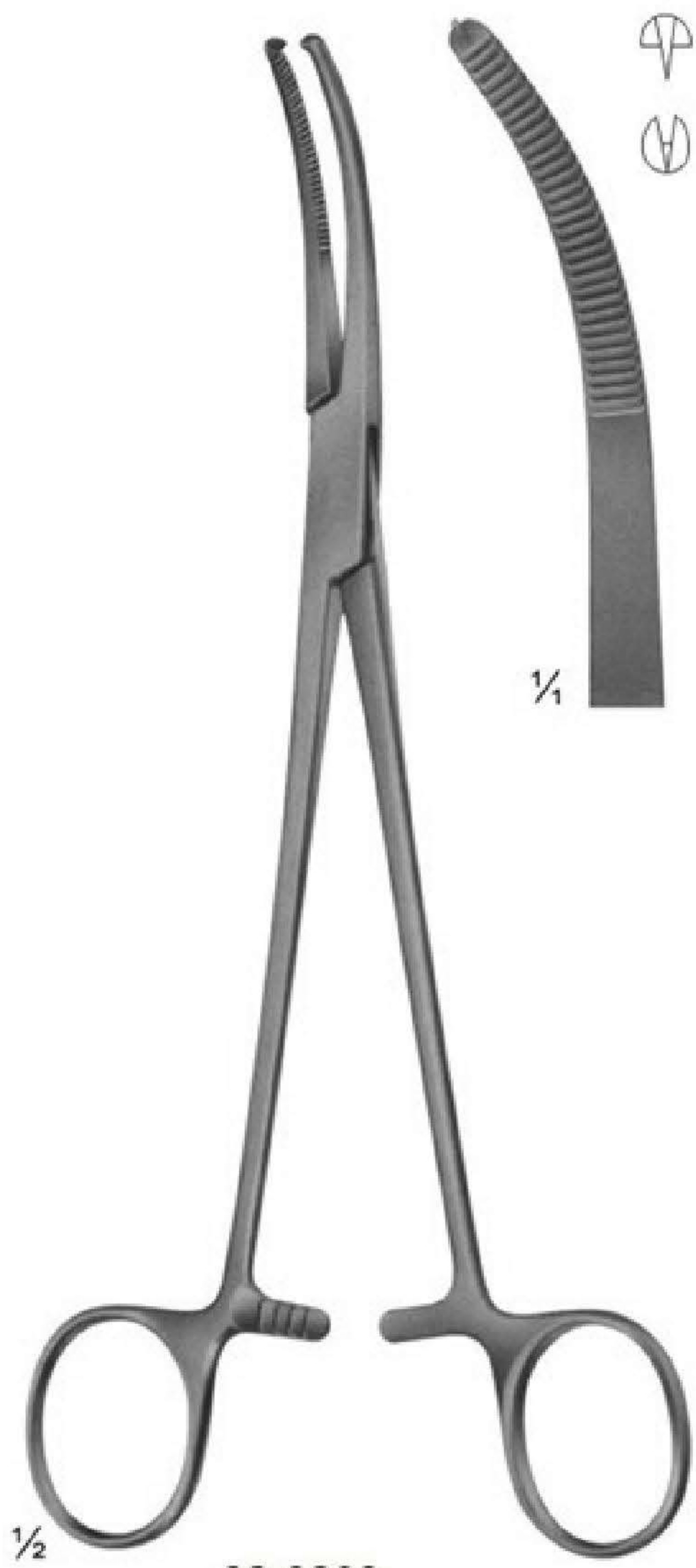

02-3803
MIKULICZ
205 mm

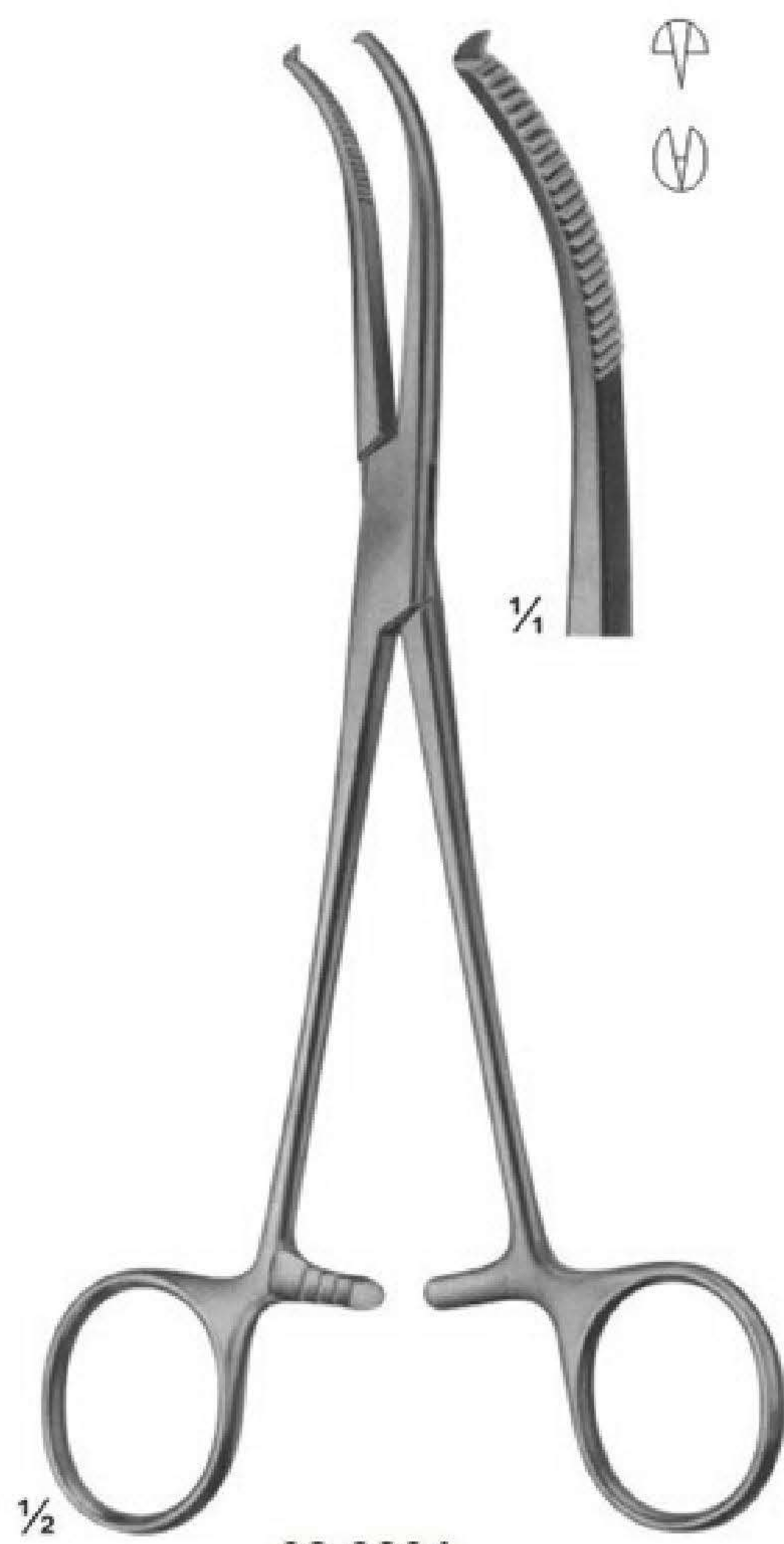

02-3804
MIKULICZ
185 mm

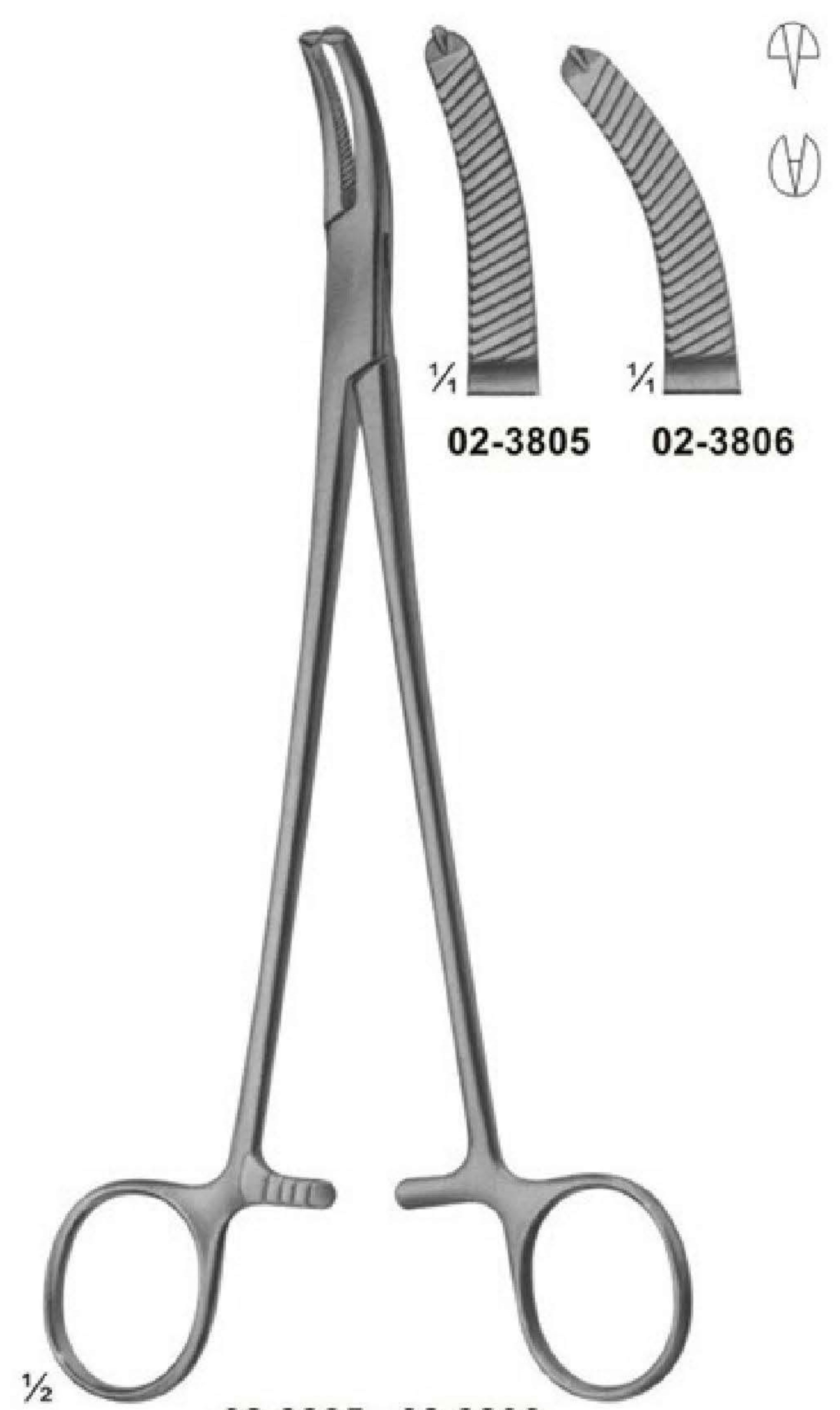

02-3805 - 02-3806
FAURE
205 mm

Hysterectomy and Haemostatic Forceps



02-3807
210 mm

02-3808
205 mm

02-3807 - 02-3808
PHANEUF



02-3809
205 mm

02-3810
245 mm

02-3809 - 02-3810
HEANEY modif.

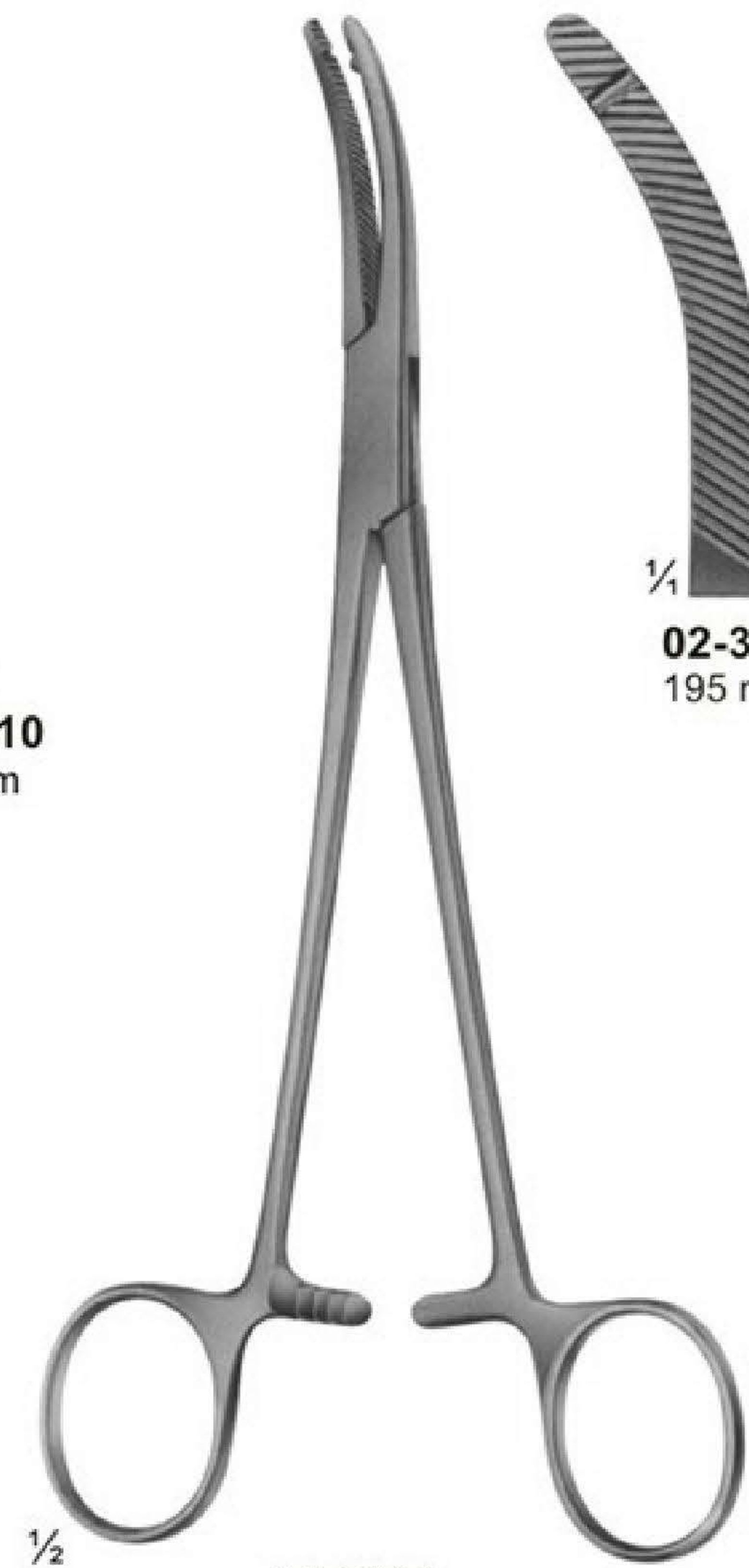

02-3811
195 mm

02-3811
HEANEY

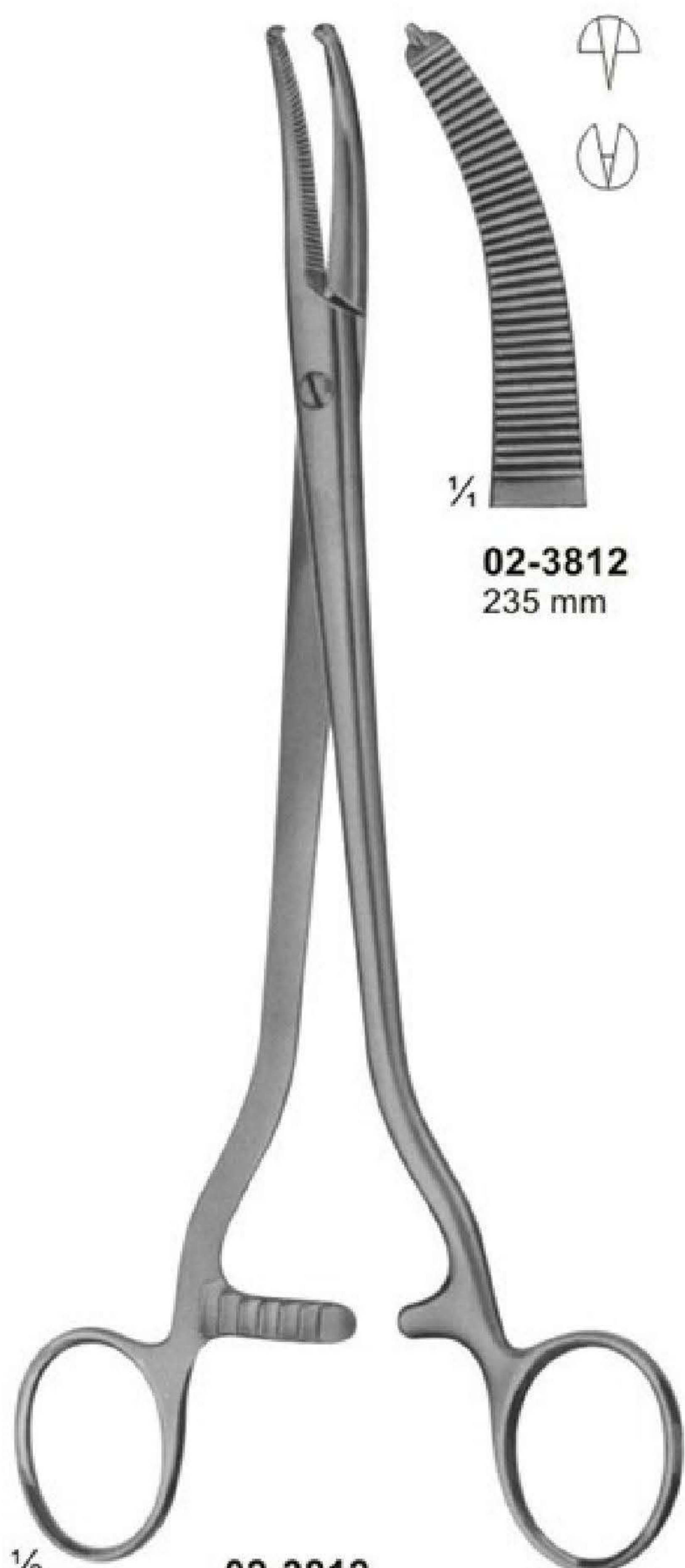

02-3812
235 mm

02-3812
WERTHEIM

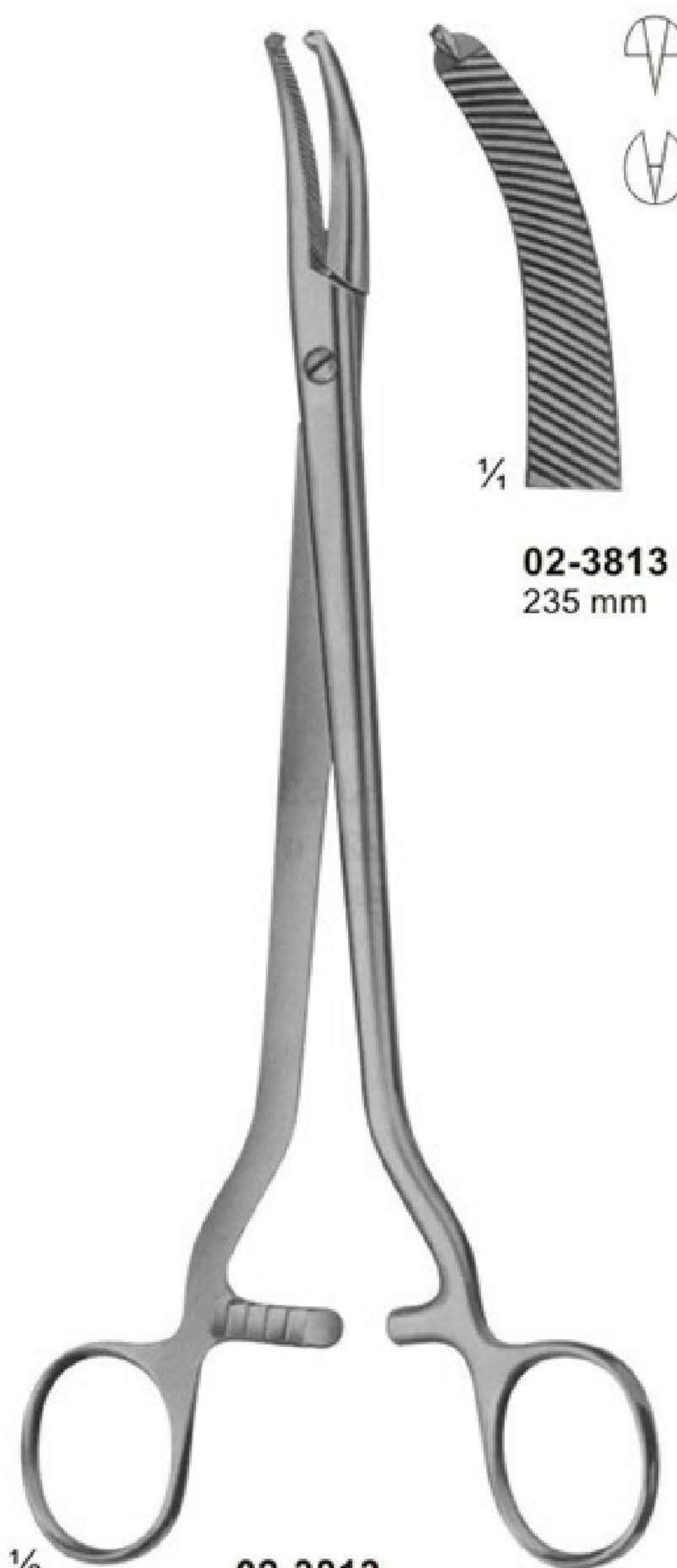

02-3813
235 mm

02-3813
WERTHEIM

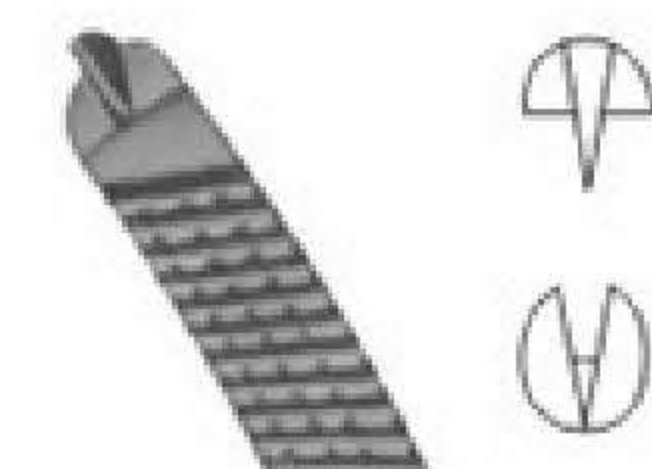

02-3814
245 mm

02-3814
WERTHEIM

Atraumata Hysterectomy Forceps and Vaginal Clamps ATRAUMATA



02-3815 - 02-3818
HEANEY



02-3815
225 mm

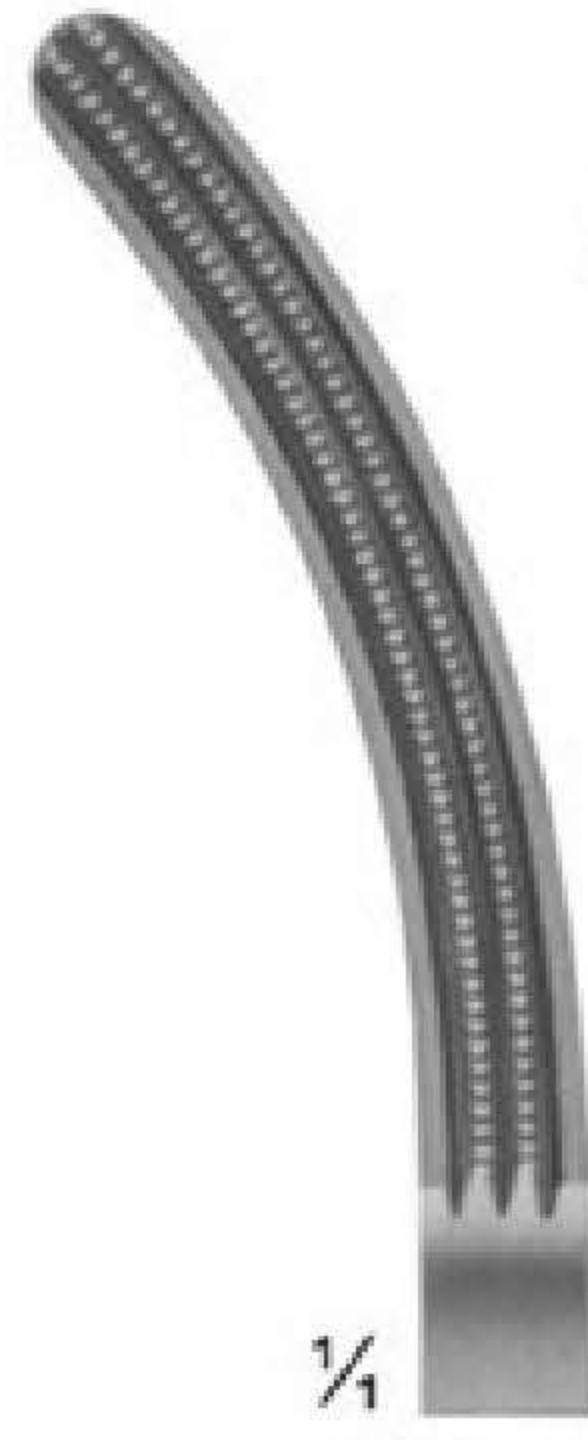

02-3816
220 mm



02-3817
215 mm

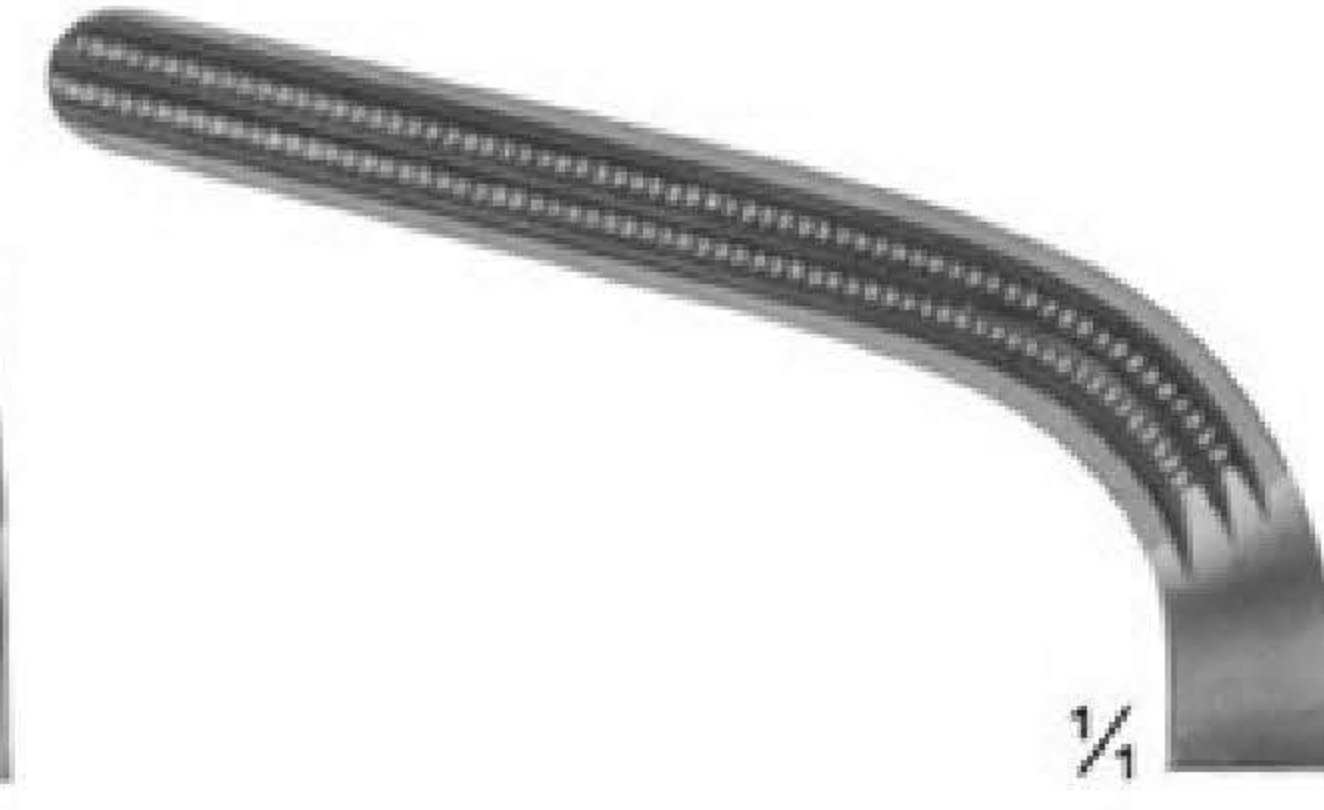

02-3818
205 mm



02-3819 - 02-3822
WERTHEIM
Parametrium clamps

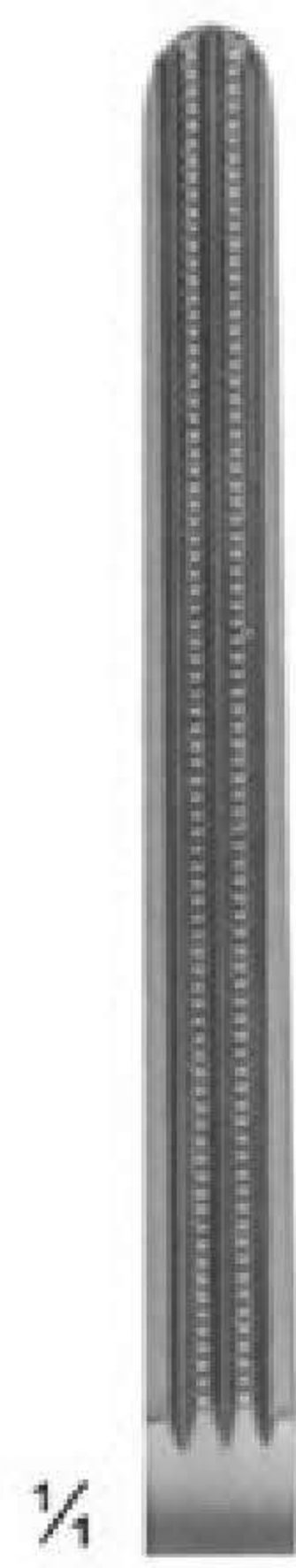

02-3819
250 mm



02-3820
245 mm



02-3821
240 mm

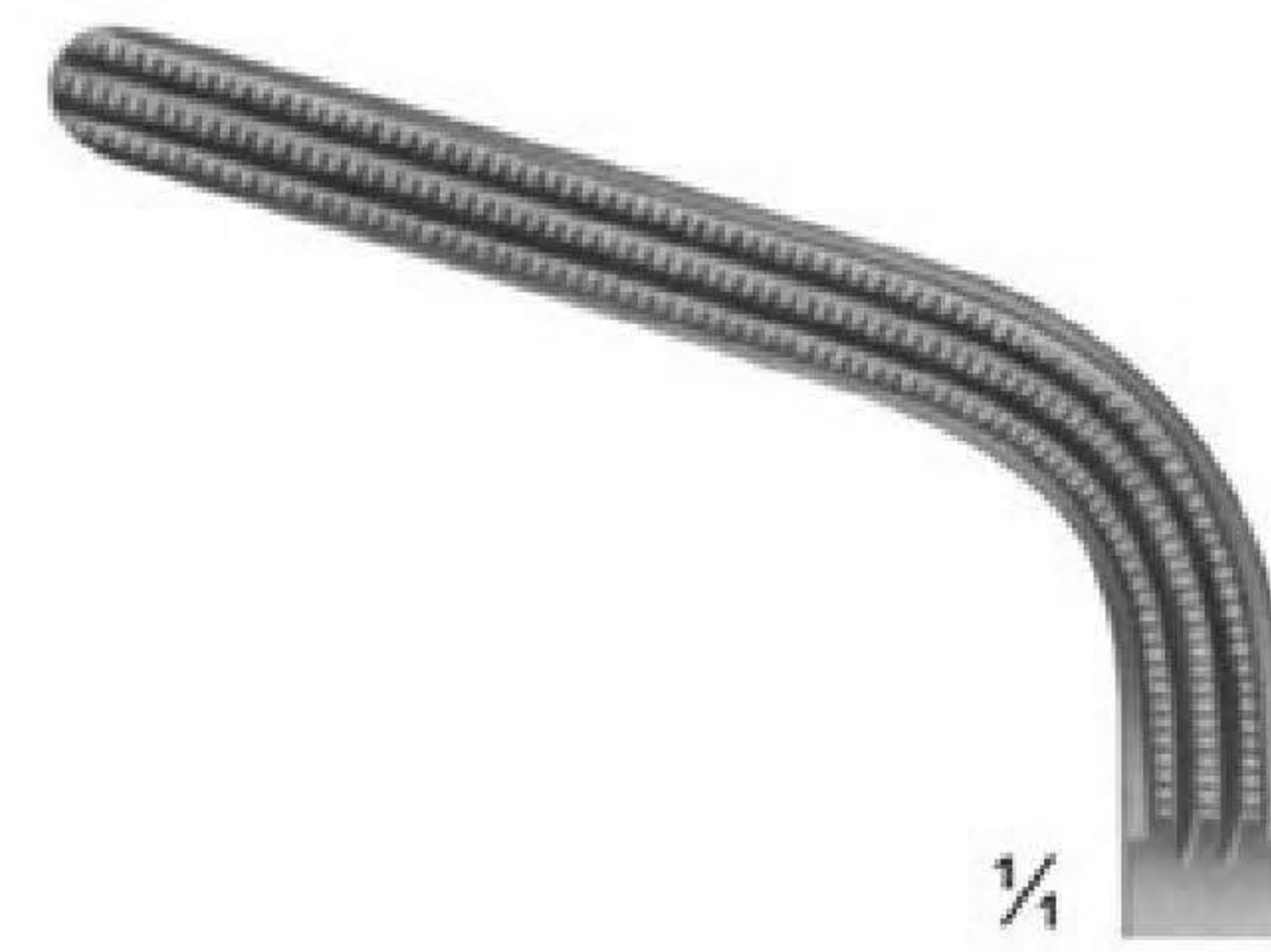

02-3822
220 mm

Hysterectomy Forceps and Vaginal Clamps and Compression Forceps ATRAUMATA



02-3823
WERTHEIM
Hysterectomy Forceps
255 mm

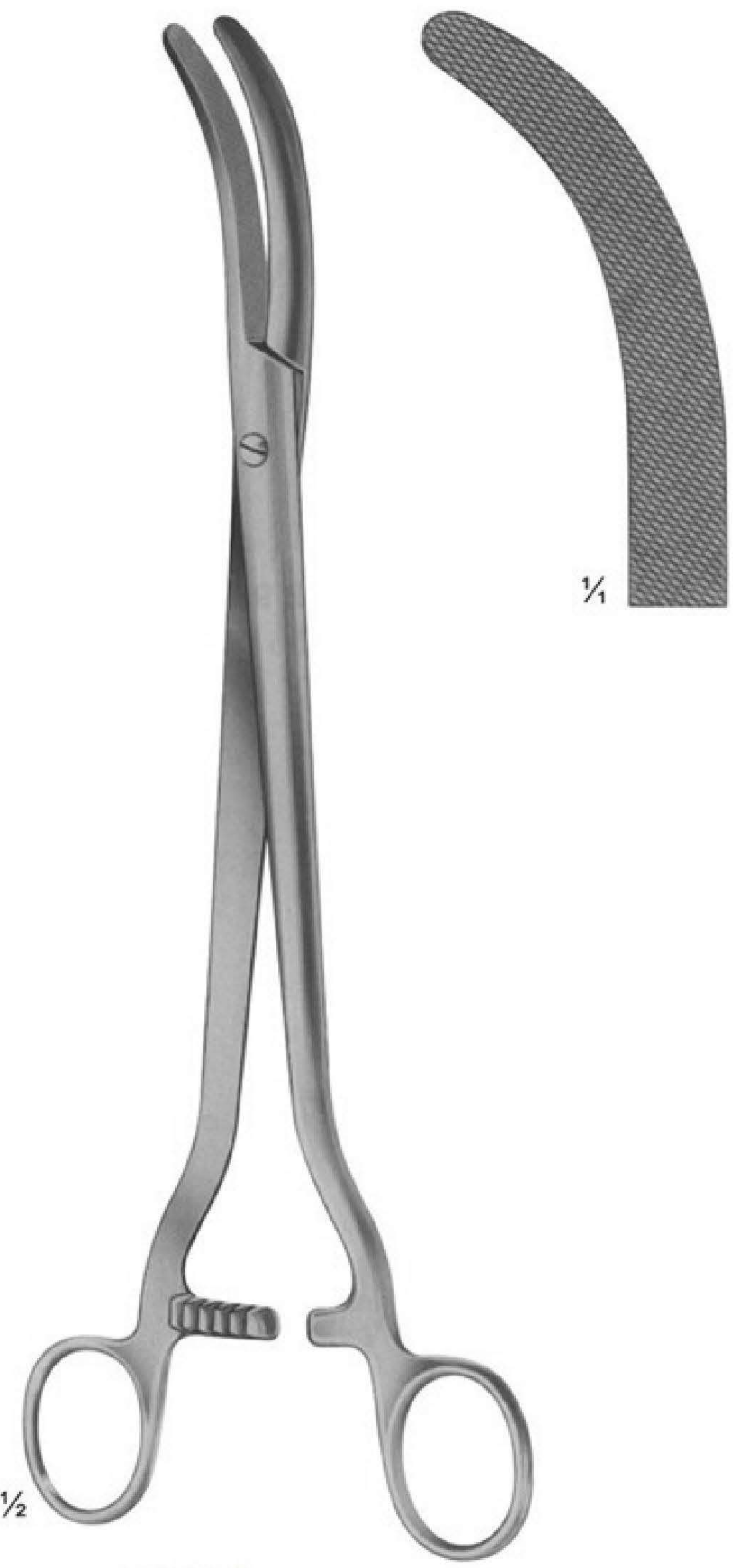

02-3824
WERTHEIM
Parametrium Clamp
260 mm

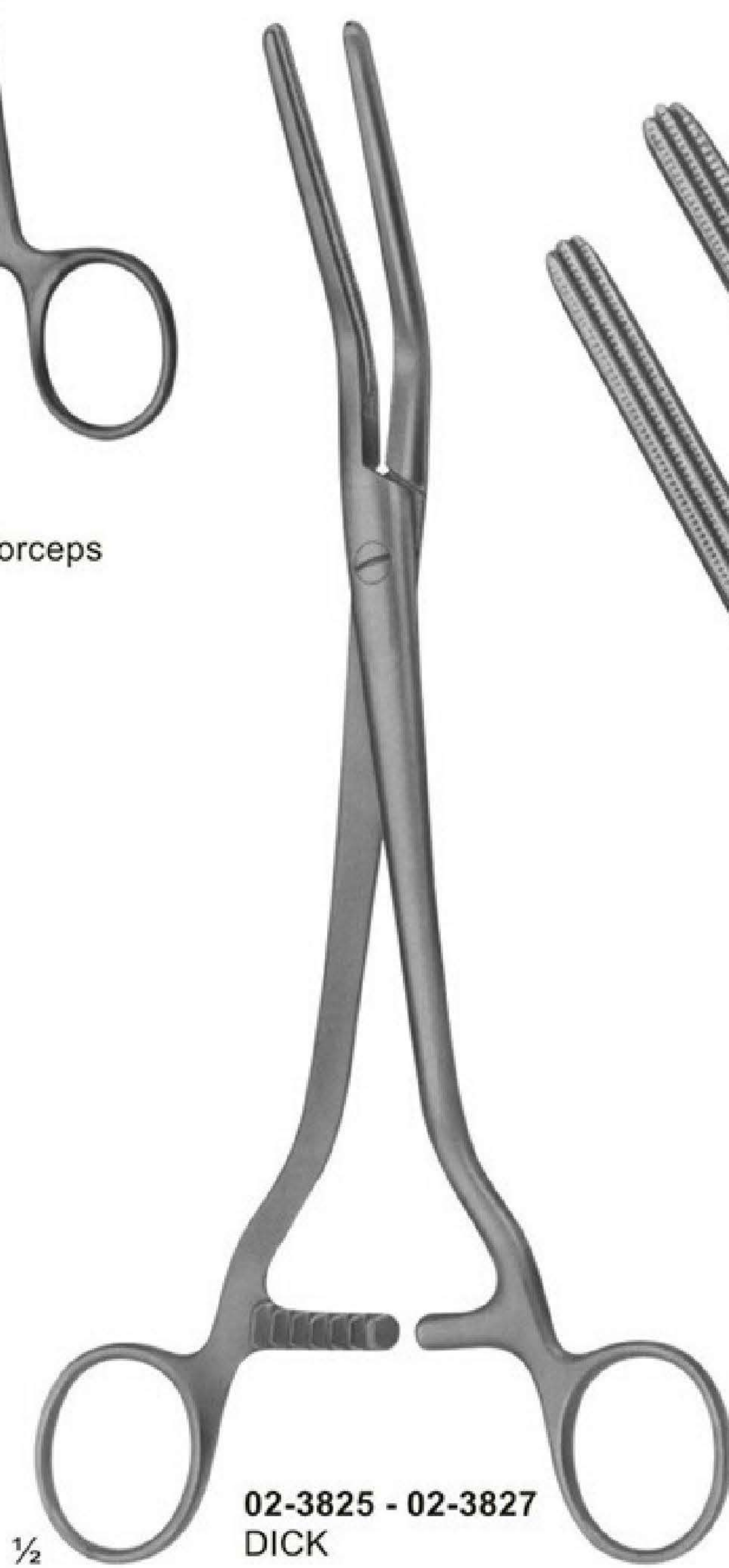

02-3825 - 02-3827
DICK

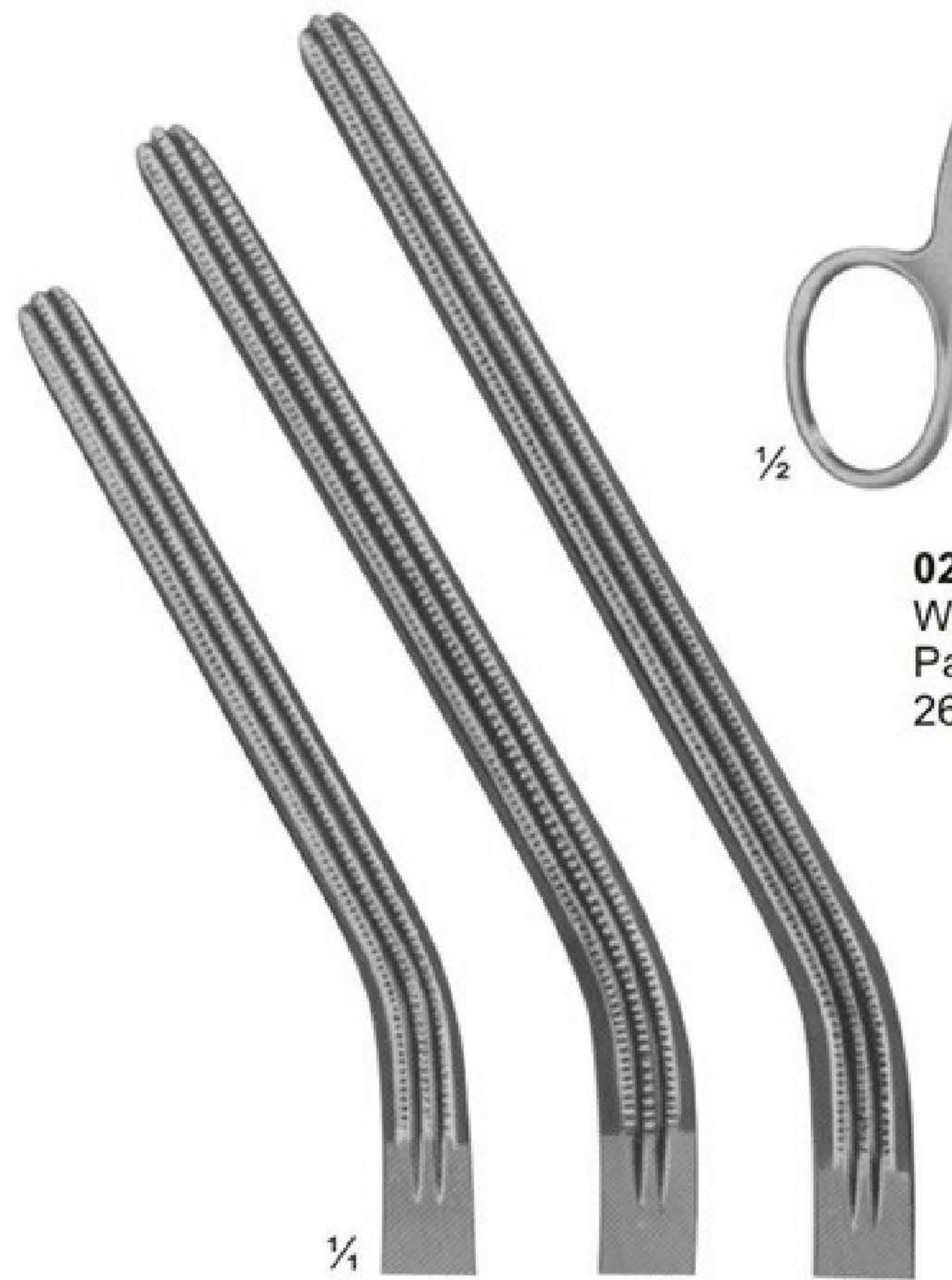

02-3825
255 mm

02-3826
265 mm

02-3827
275 mm

Clamps and Compression Forceps

ATRAUMATA



02-3828
 WERTHEIM
 250 mm

1/2



1/4

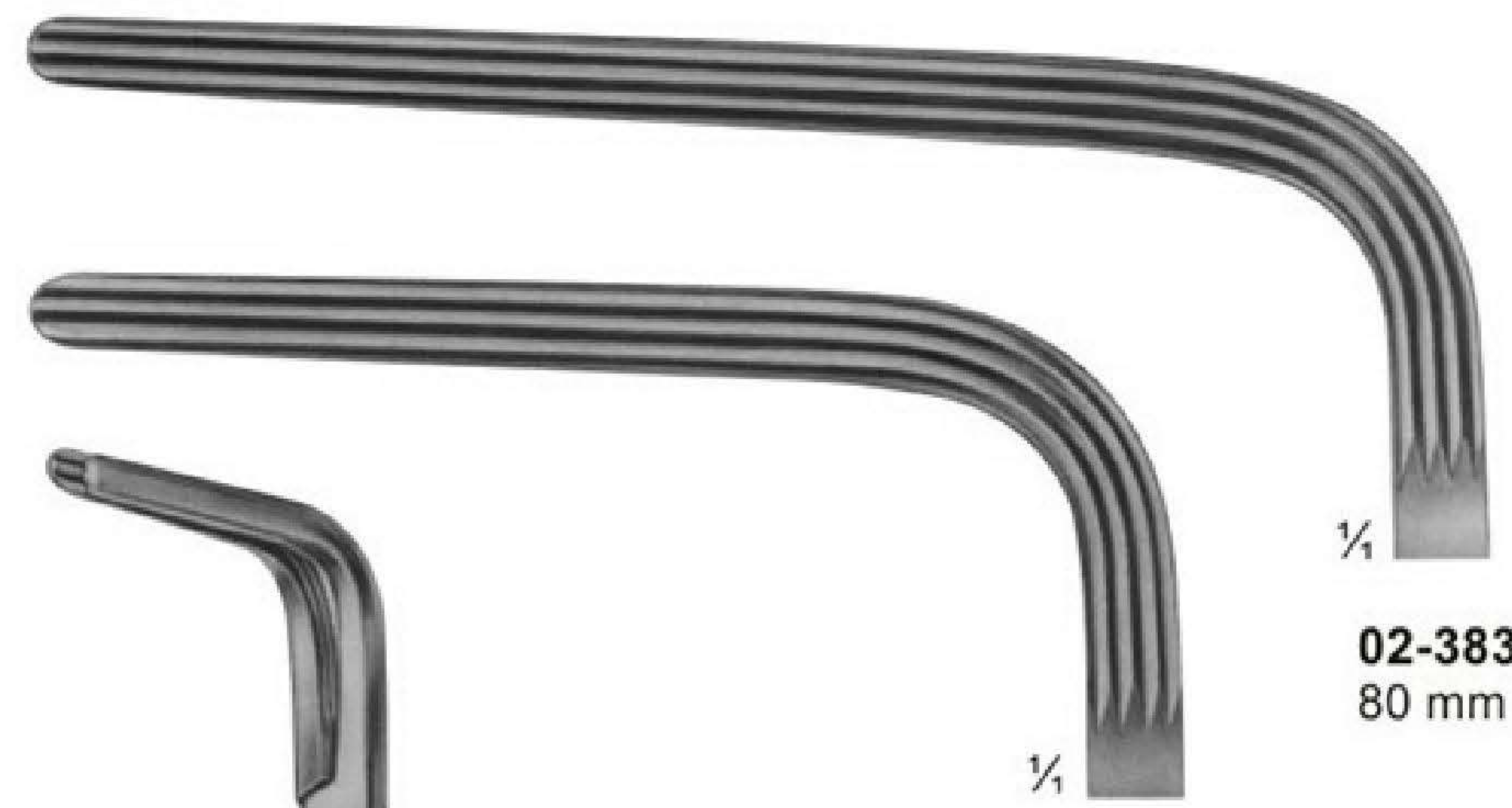

02-3831
 80 mm

1/4

02-3830
 60 mm



02-3829
 WERTHEIM-CULLEN
 215 mm

1/2



1/4



02-3830 - 02-3831
 230 mm

1/2