

Intestinal and Tissue Grasping Forceps

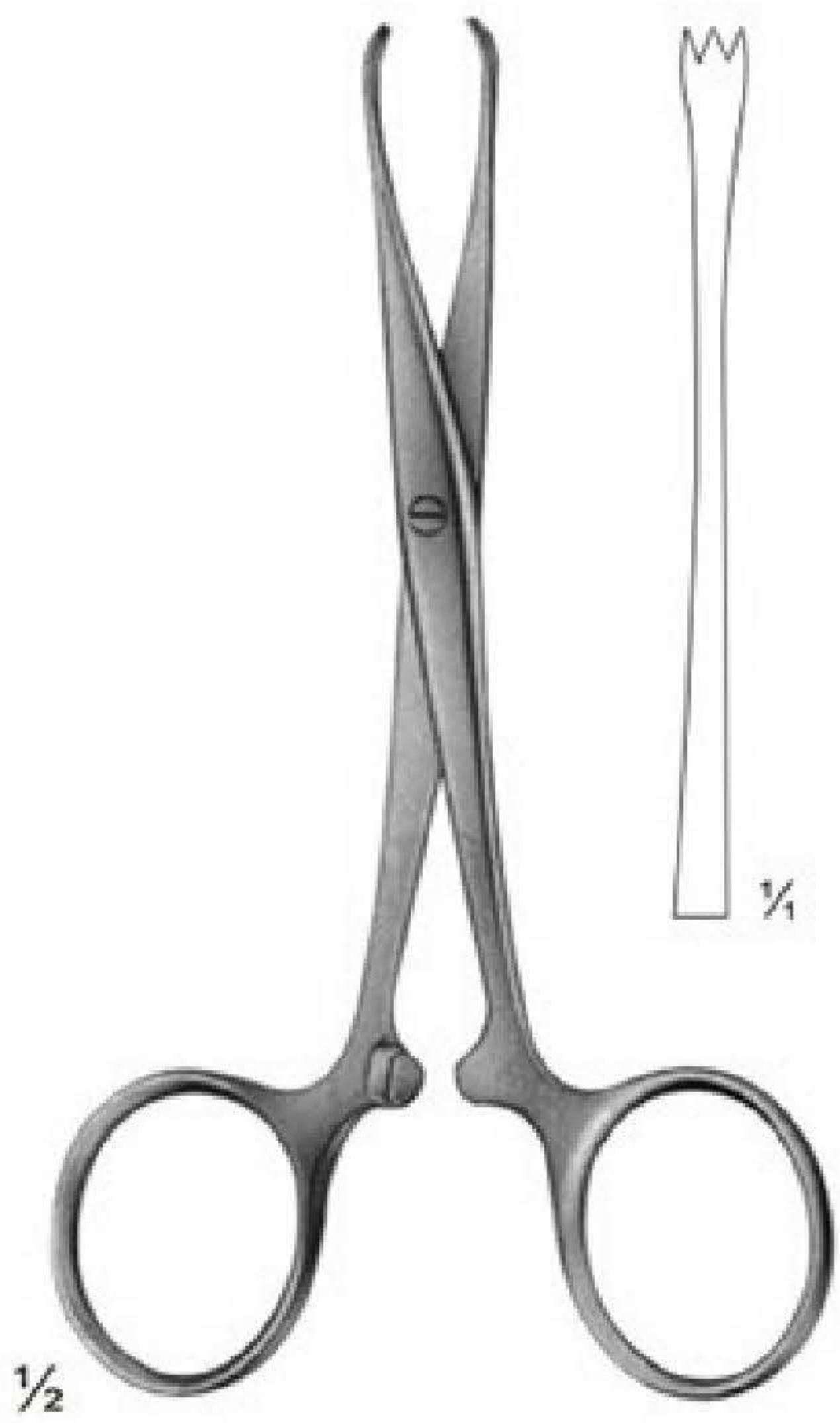

03-5473
CHAPUT
 2 X 3 teeth, sharp
 125 mm,

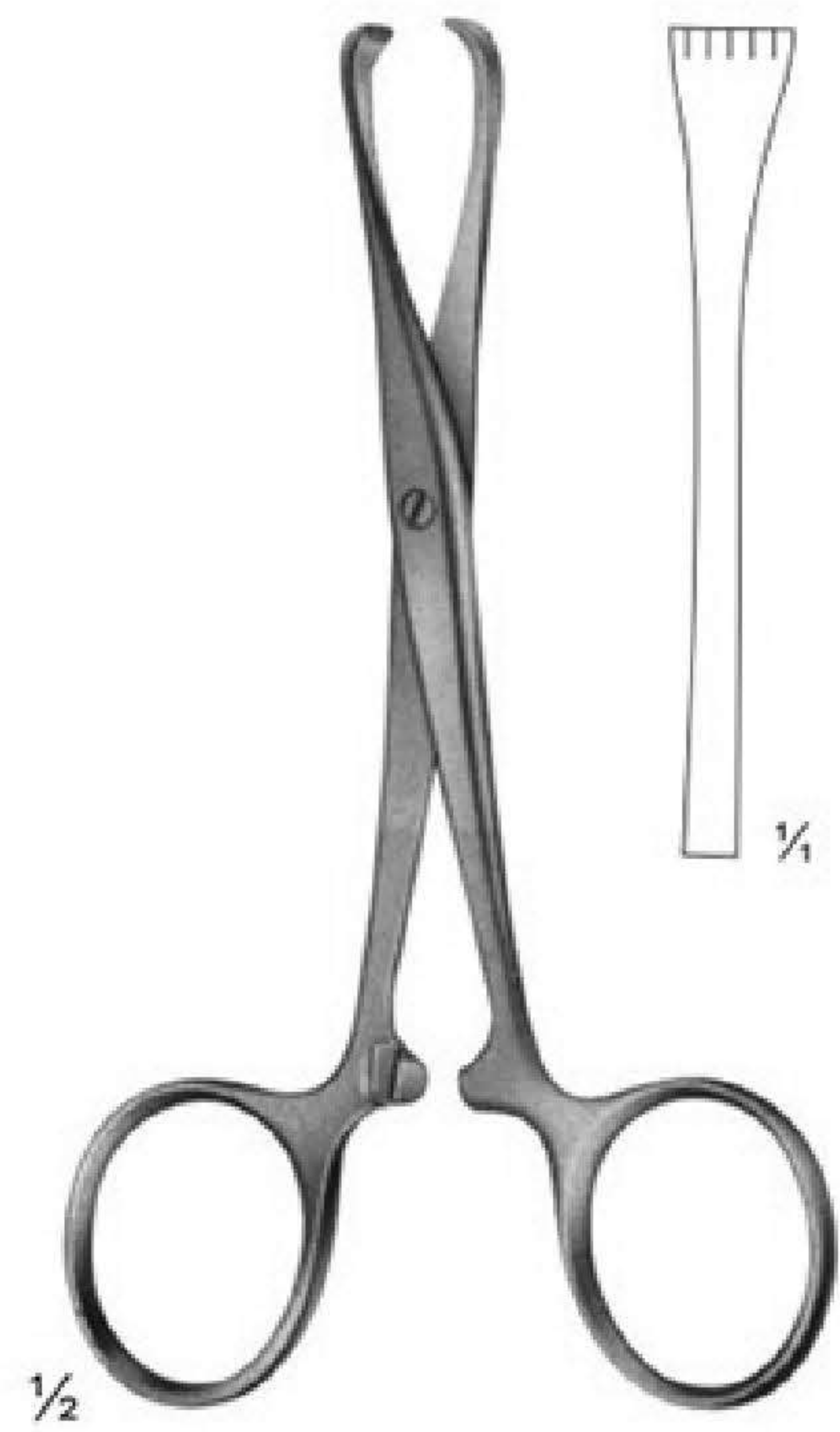

03-5474
TUFFIER
 5 X 6 teeth, sharp
 125 mm,



03-5475
BOYS-ALLIS
 5 X 6 teeth, sharp
 155 mm,

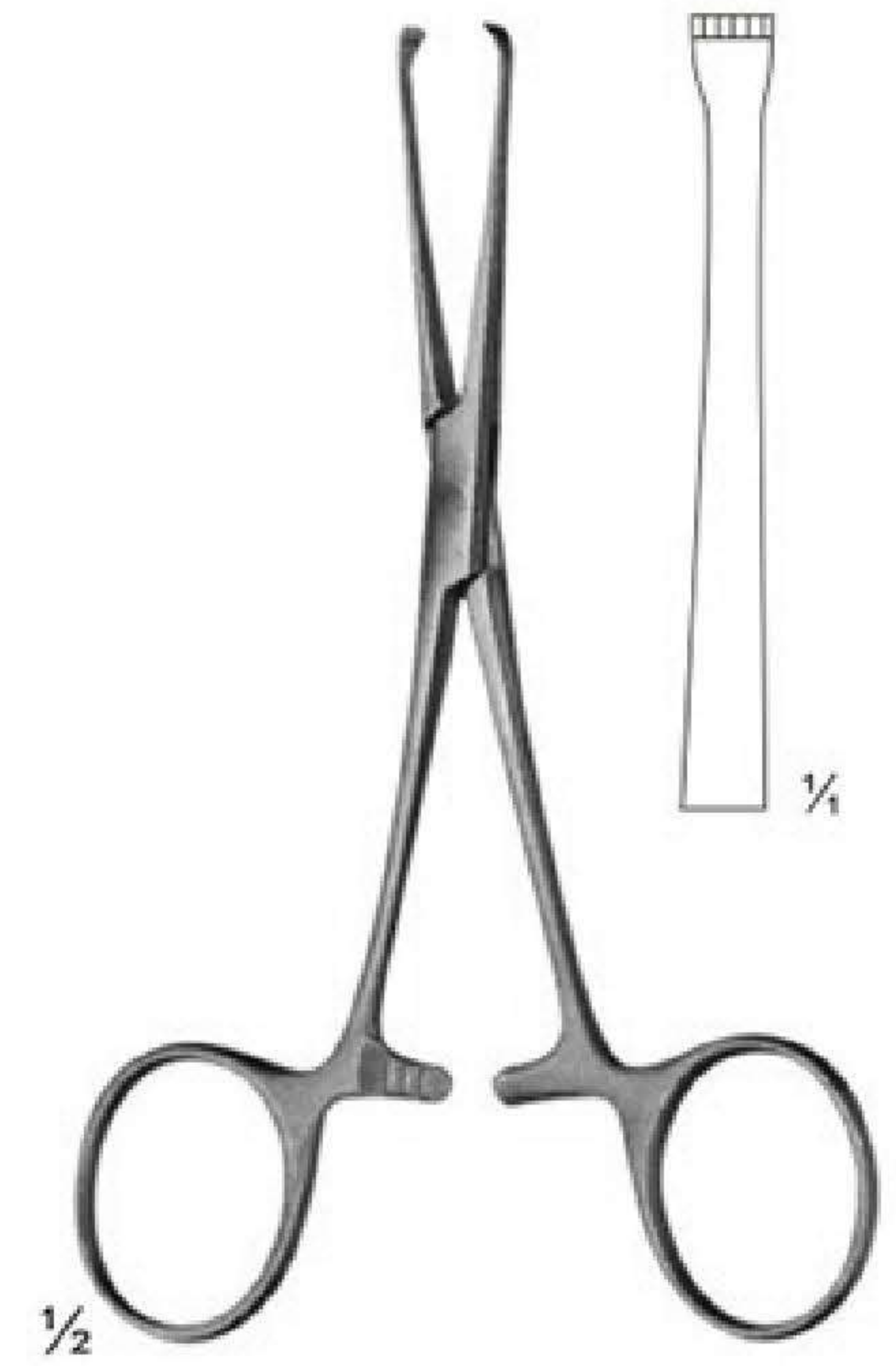

03-5476
BABY-ALLIS
 4 X 5 teeth
 130mm

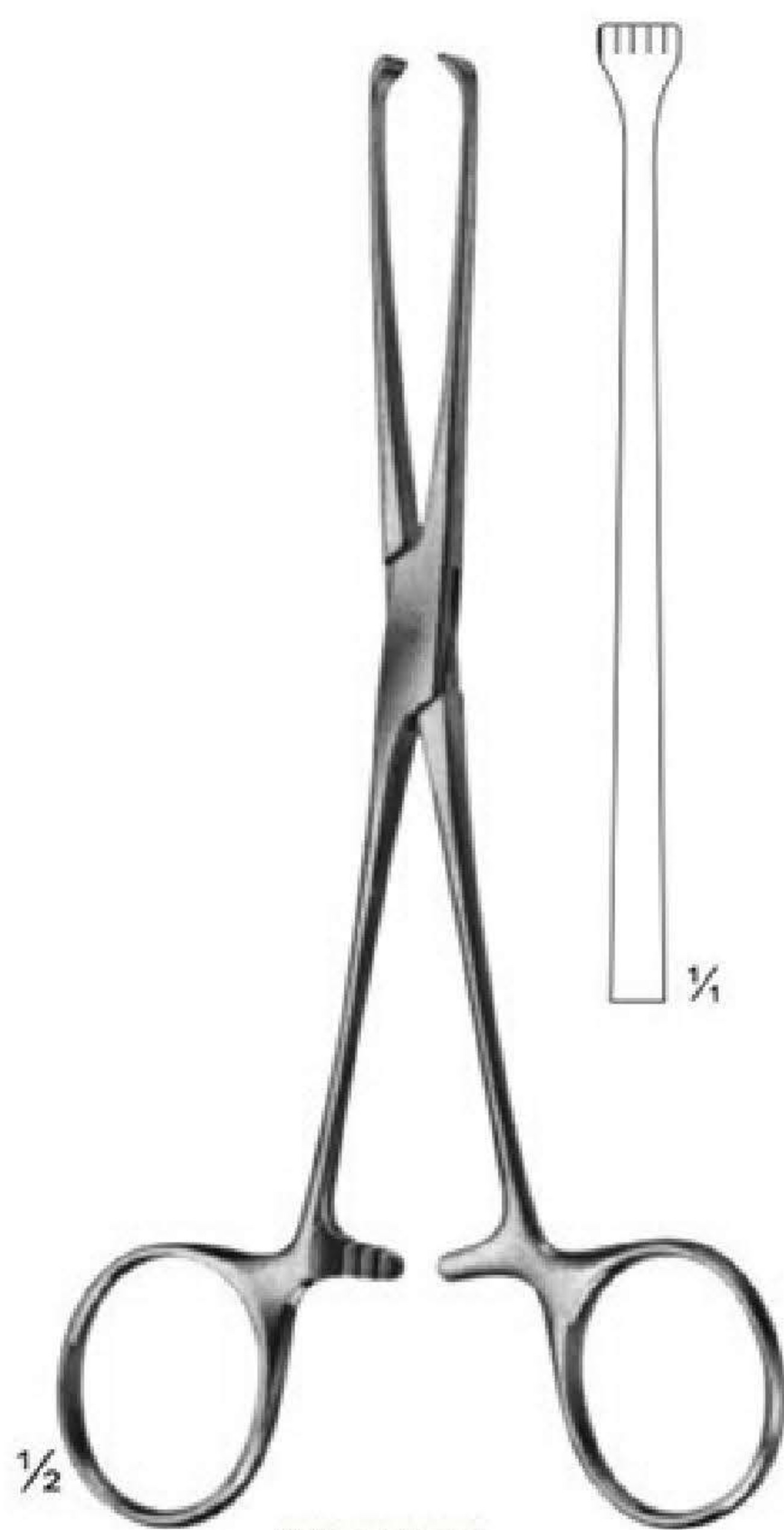

03-5477
ALLIS
 4 X 5 teeth
 155 mm,

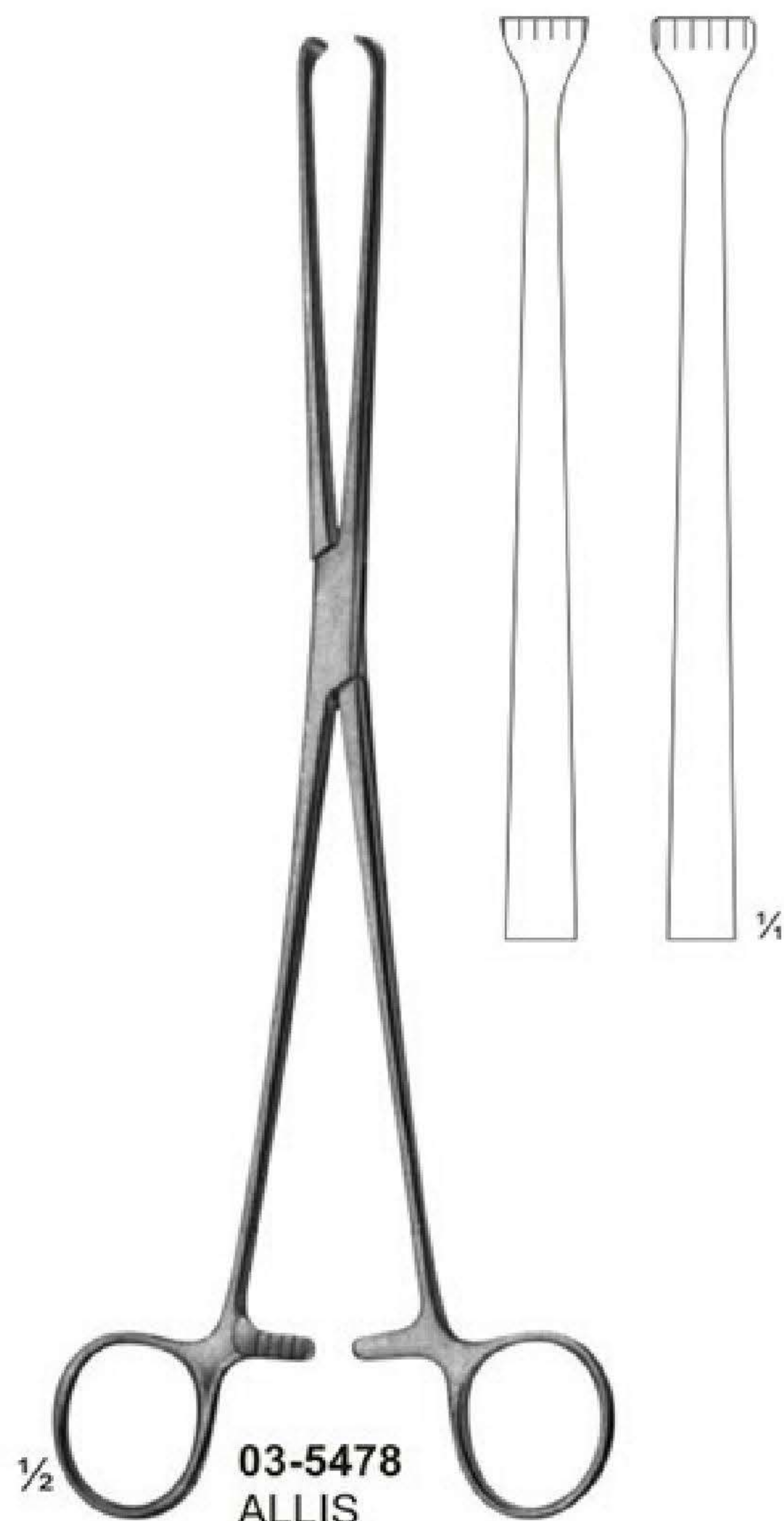

03-5478
ALLIS
 190 mm,
03-5479
 255 mm,
 5 X 6 teeth
 Slender pattern

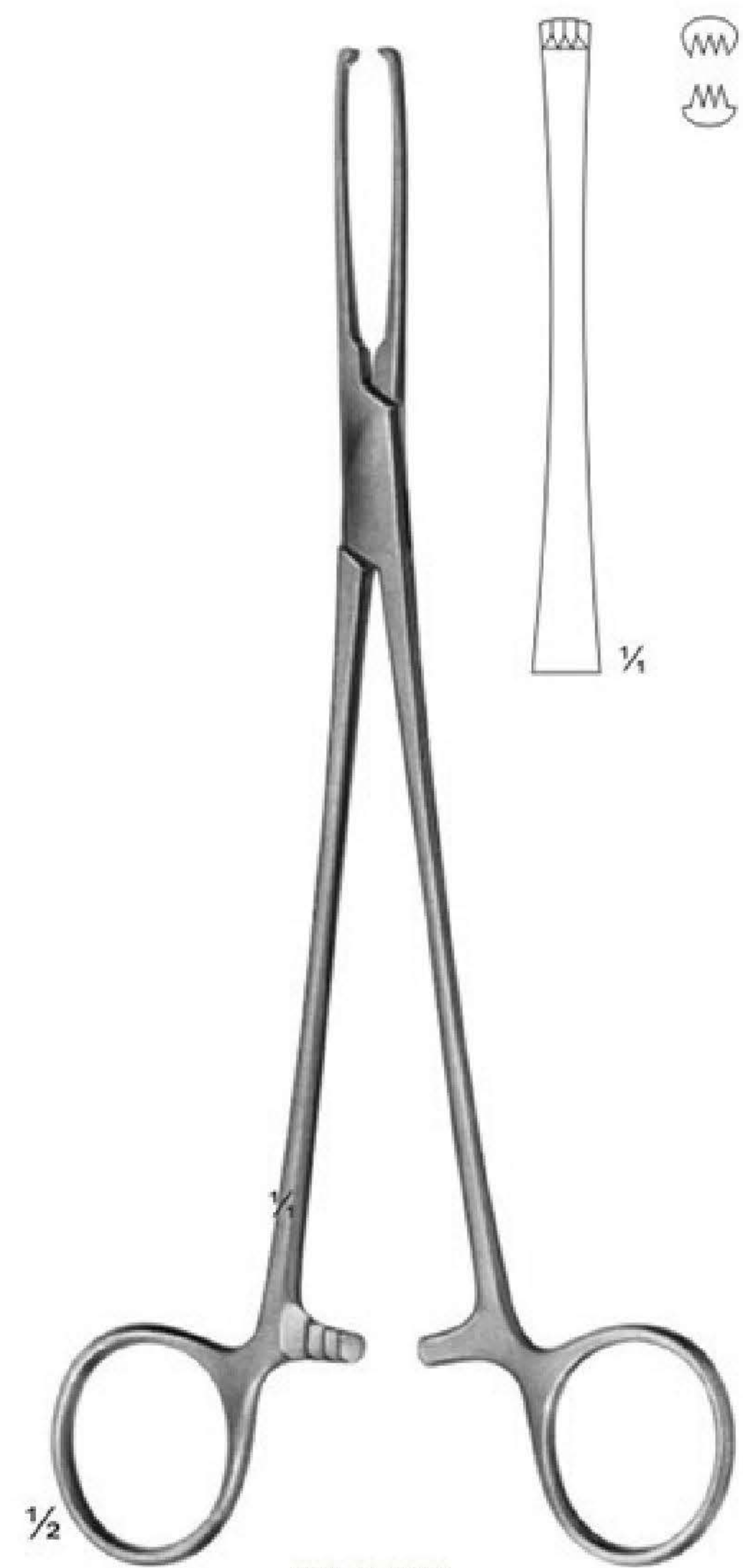

03-5480
JUDD-ALLIS
 3 X 4 teeth
 195 mm,

Intestinal Grasping Forceps



03-5481
 BABCOCK
 155 mm

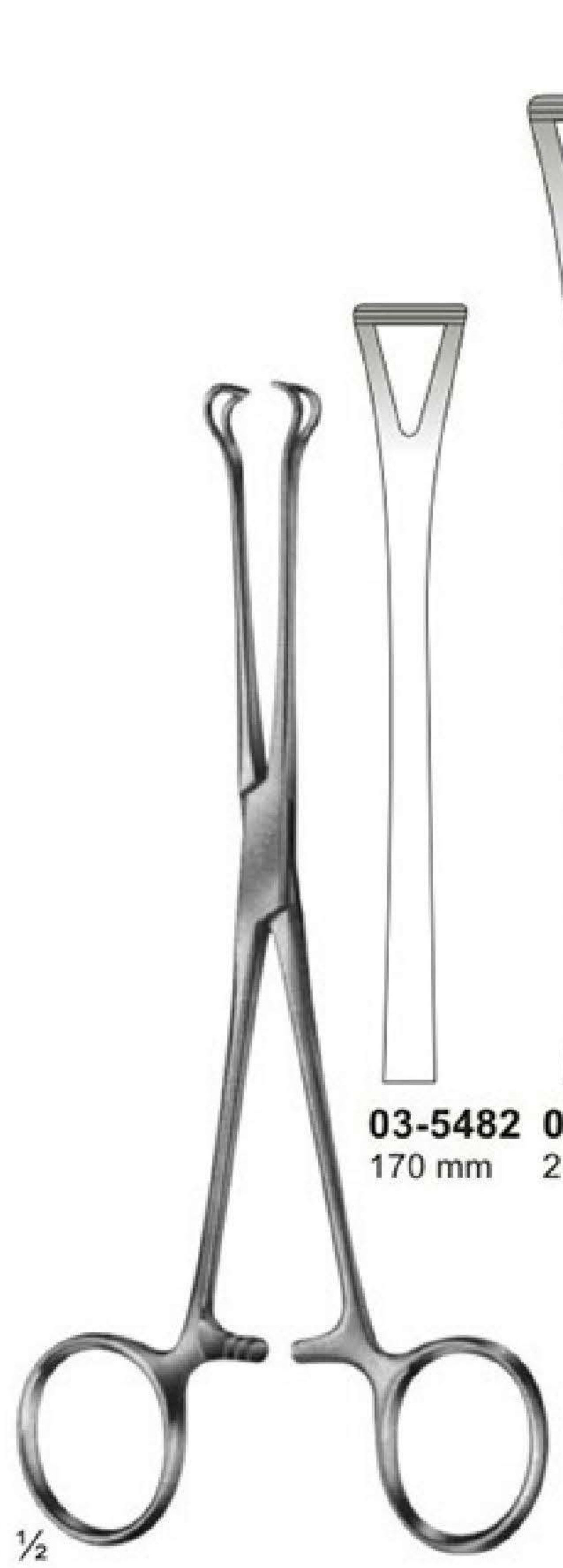

03-5482 - 03-5483
 BABCOCK



03-5484
 BABCOCK
 220 mm

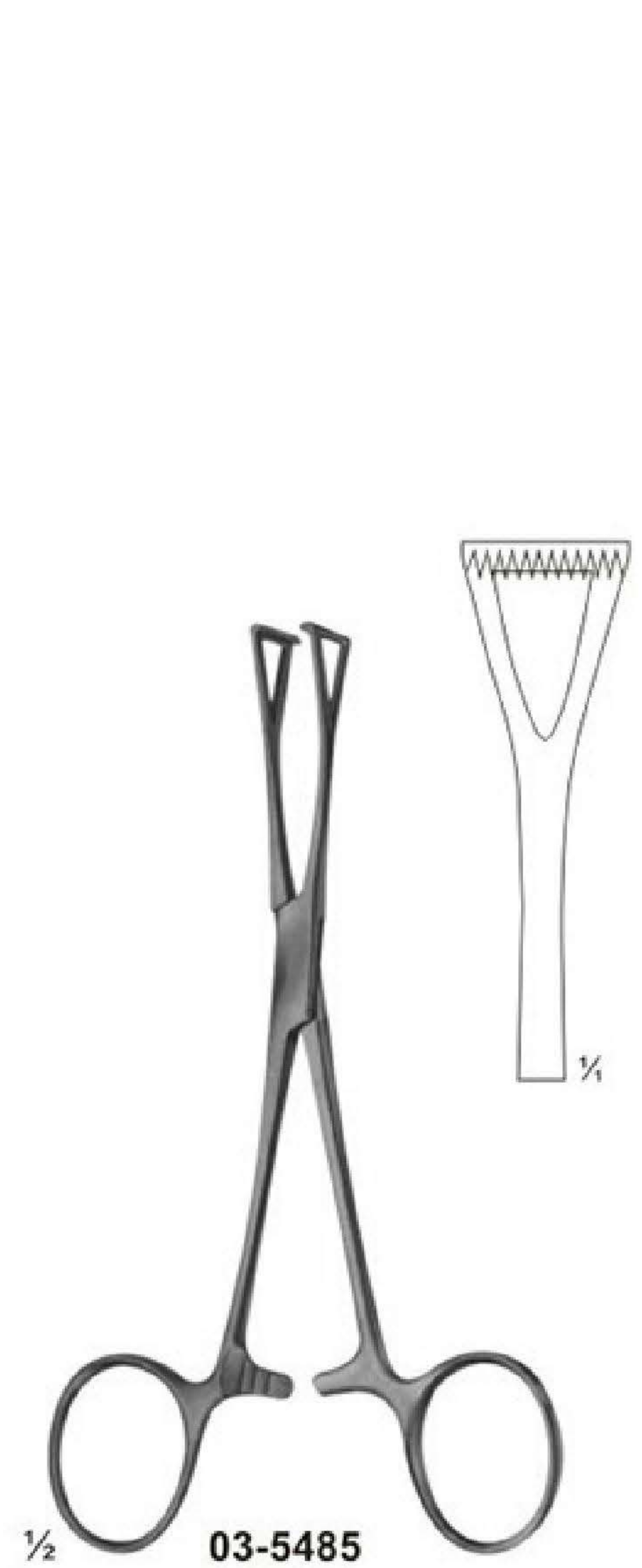

03-5485
 COLLIN
 140 mm,

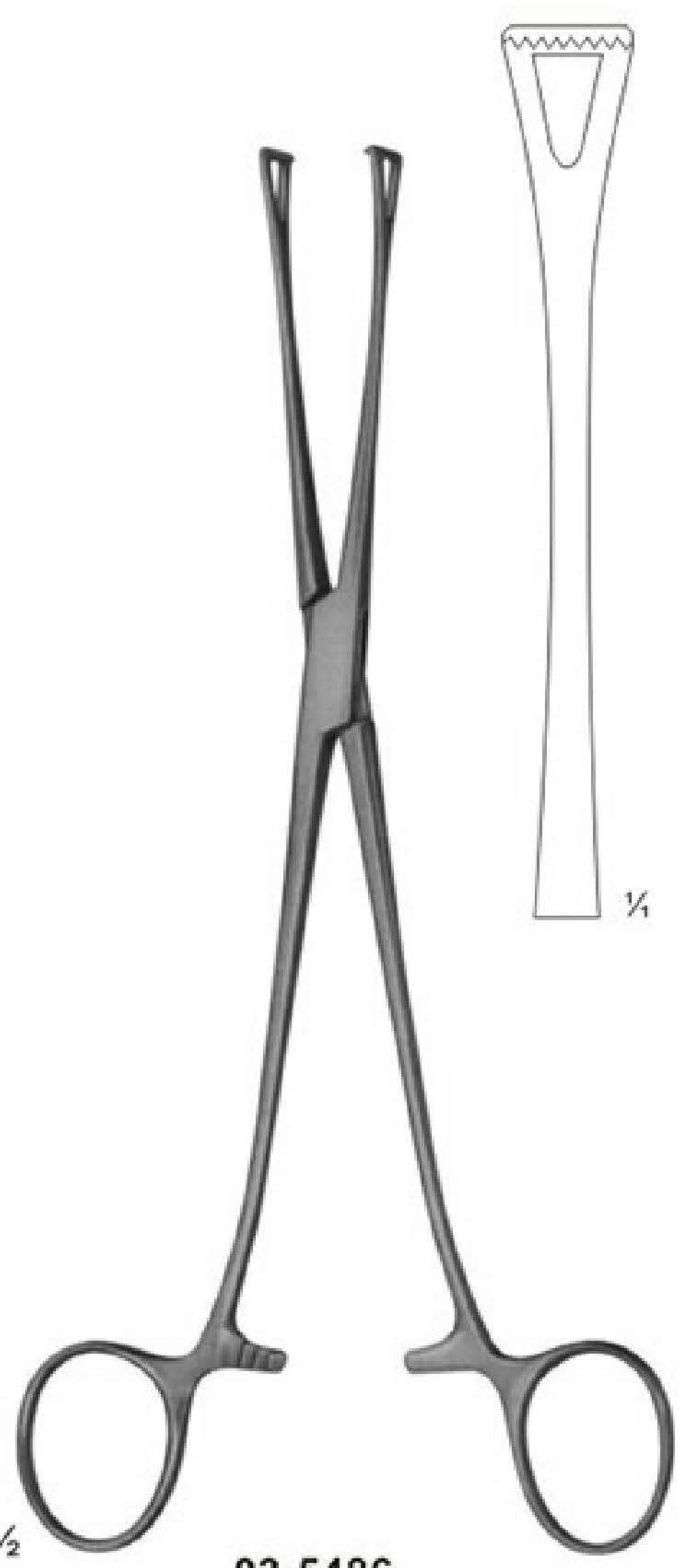

03-5486
 LOCKWOOD
 200 mm,



03-5487
 DUVAL-COLLIN
 195 mm
03-5488
 200 mm

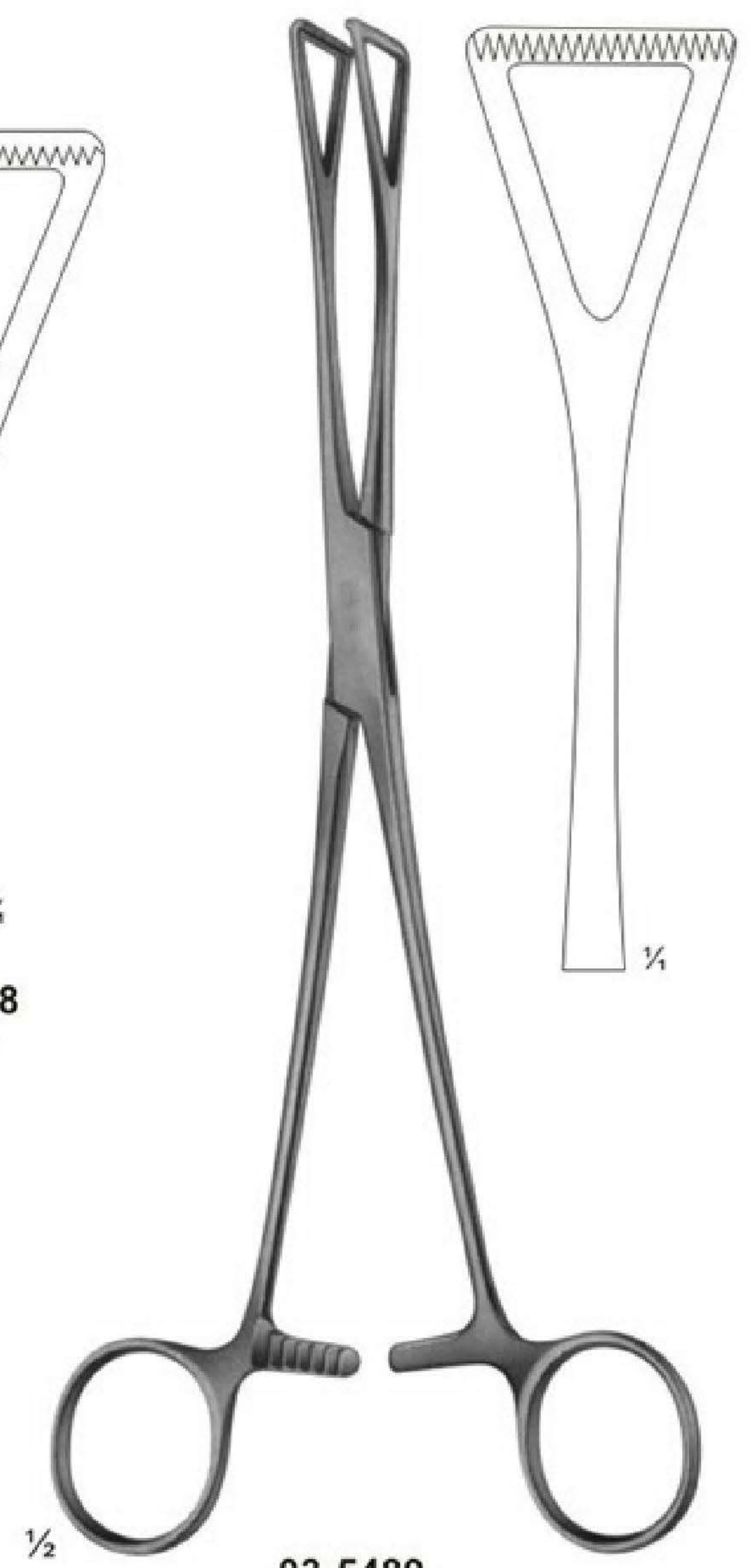

03-5489
 DUVAL
 230 mm,

Organ - Tissue Grasping, Intestinal and Dissecting Forceps



03-5490 130 mm
03-5491 155 mm
03-5492 195 mm

03-5490 - 03-5492
LANE

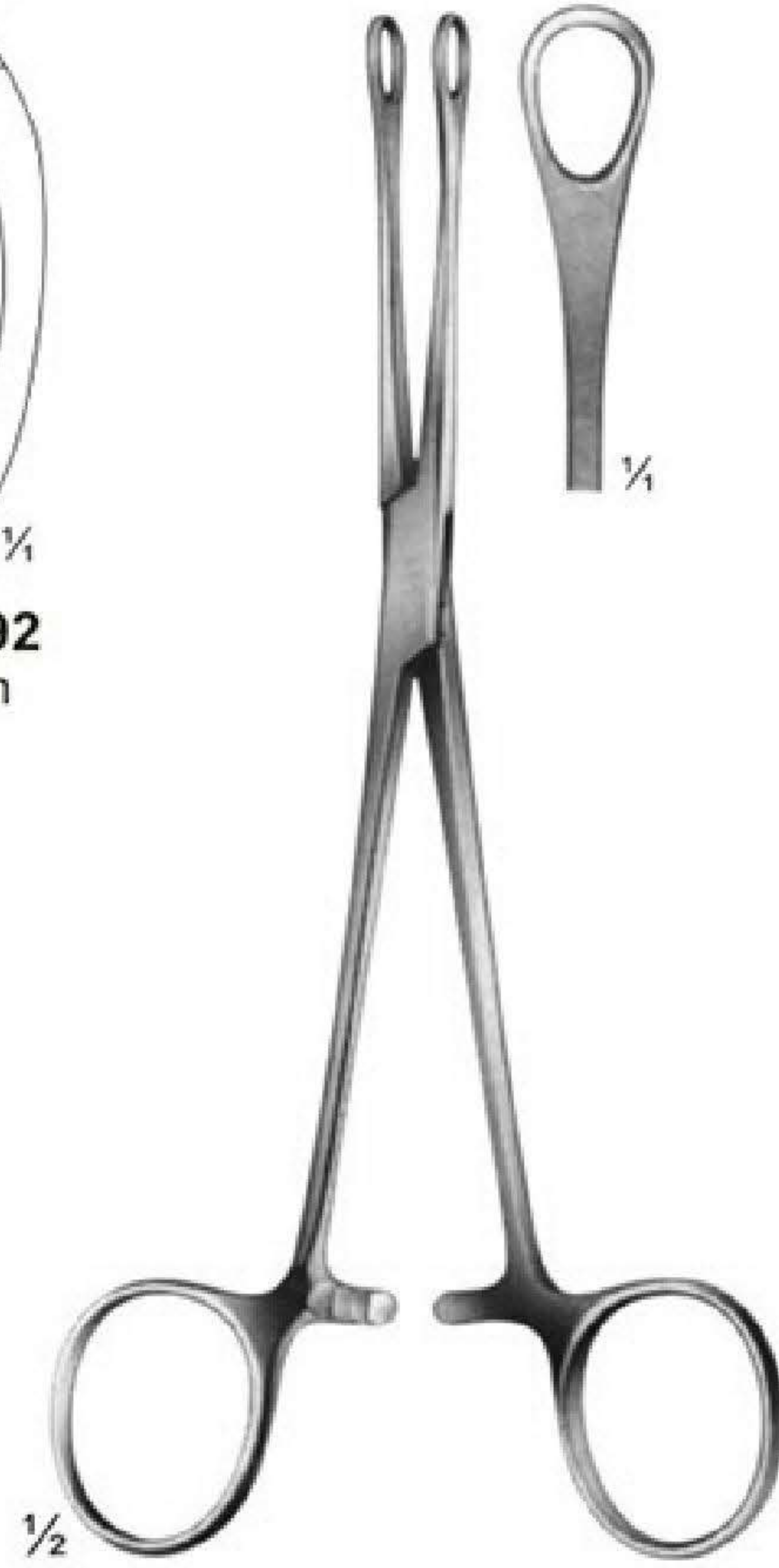

03-5493
WILLIAMS
160 mm



03-5494
DENIS
BROWNE
190 mm

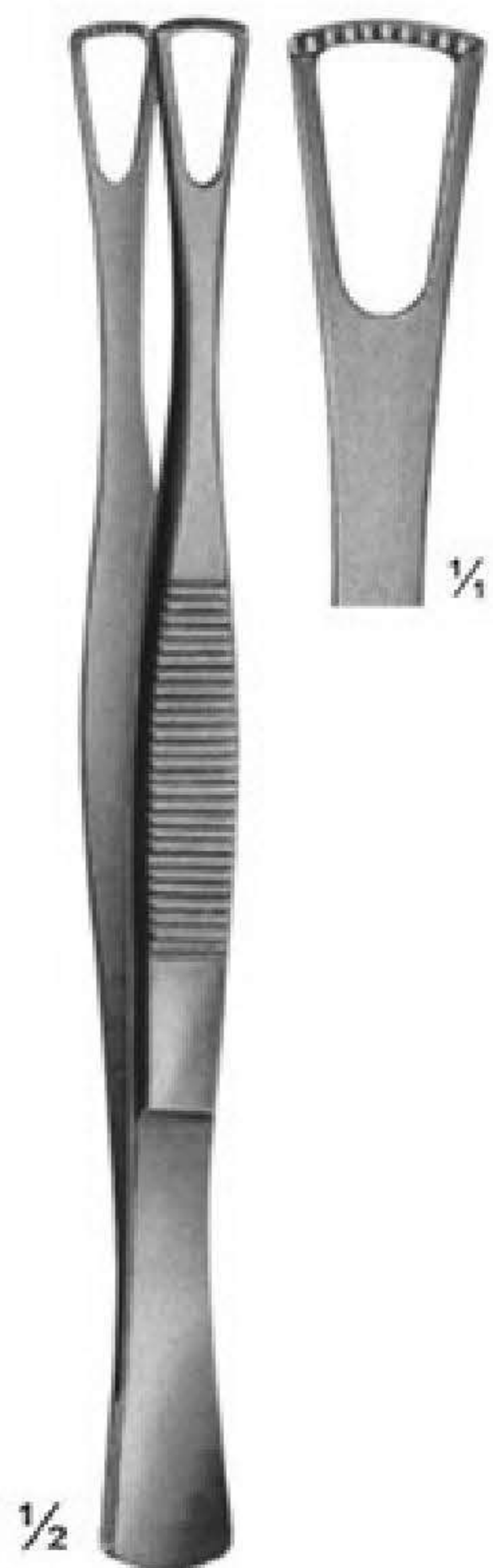

03-5495
DUVAL
140 mm



03-5496 - 03-5497
WANGENSTEEN
03-5496 150 mm
03-5497 230 mm

03-5496 03-5497
DUROGRIP

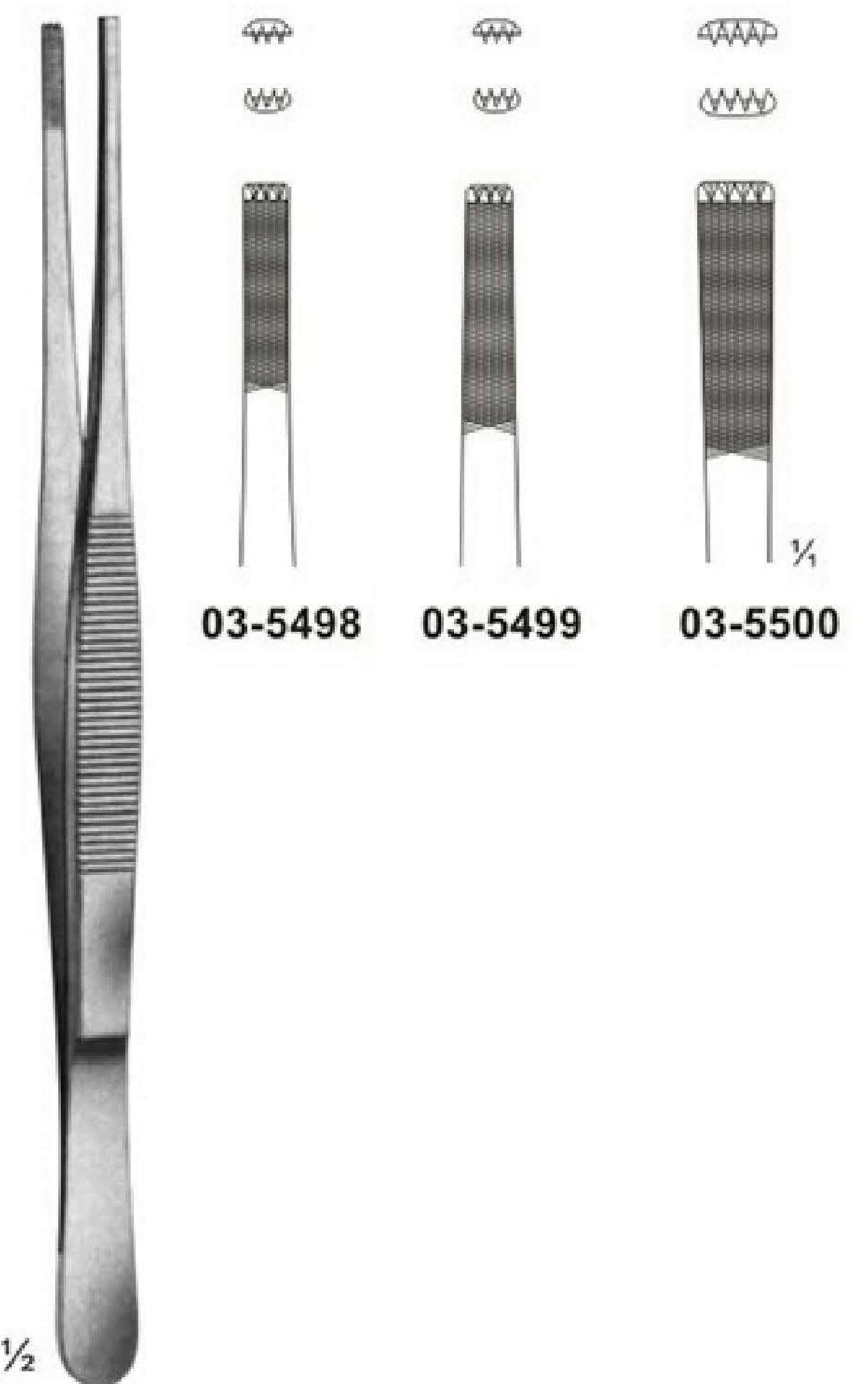

03-5498 - 03-5500
STILLE-BARRAYA
03-5498 180mm
03-5499 200mm
03-5500 250mm

Organ - Tissue Grasping & Intestinal Forceps ATRAUMATA

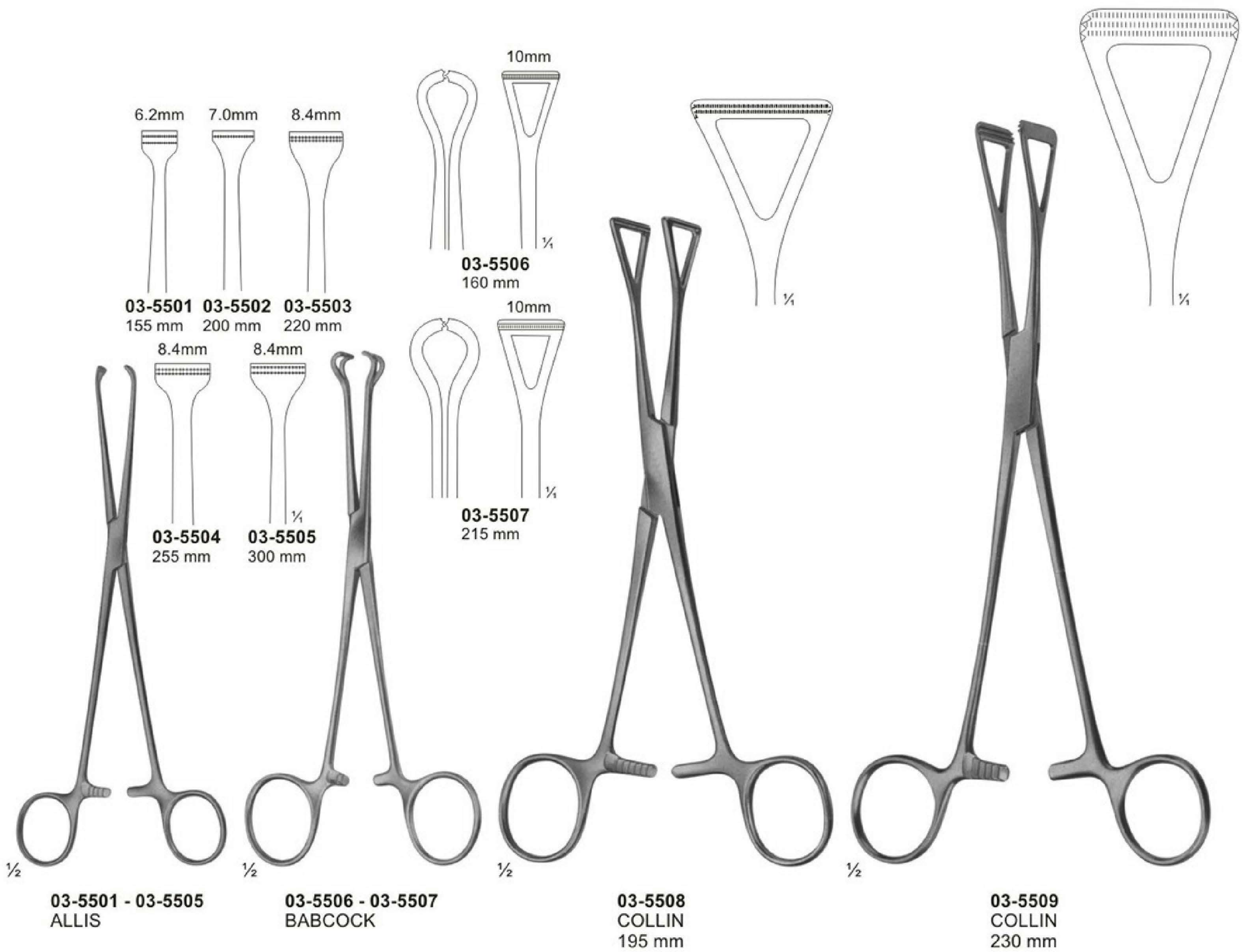

Ultra - Light - Forceps, Dissecting Forceps ATRAUMATA

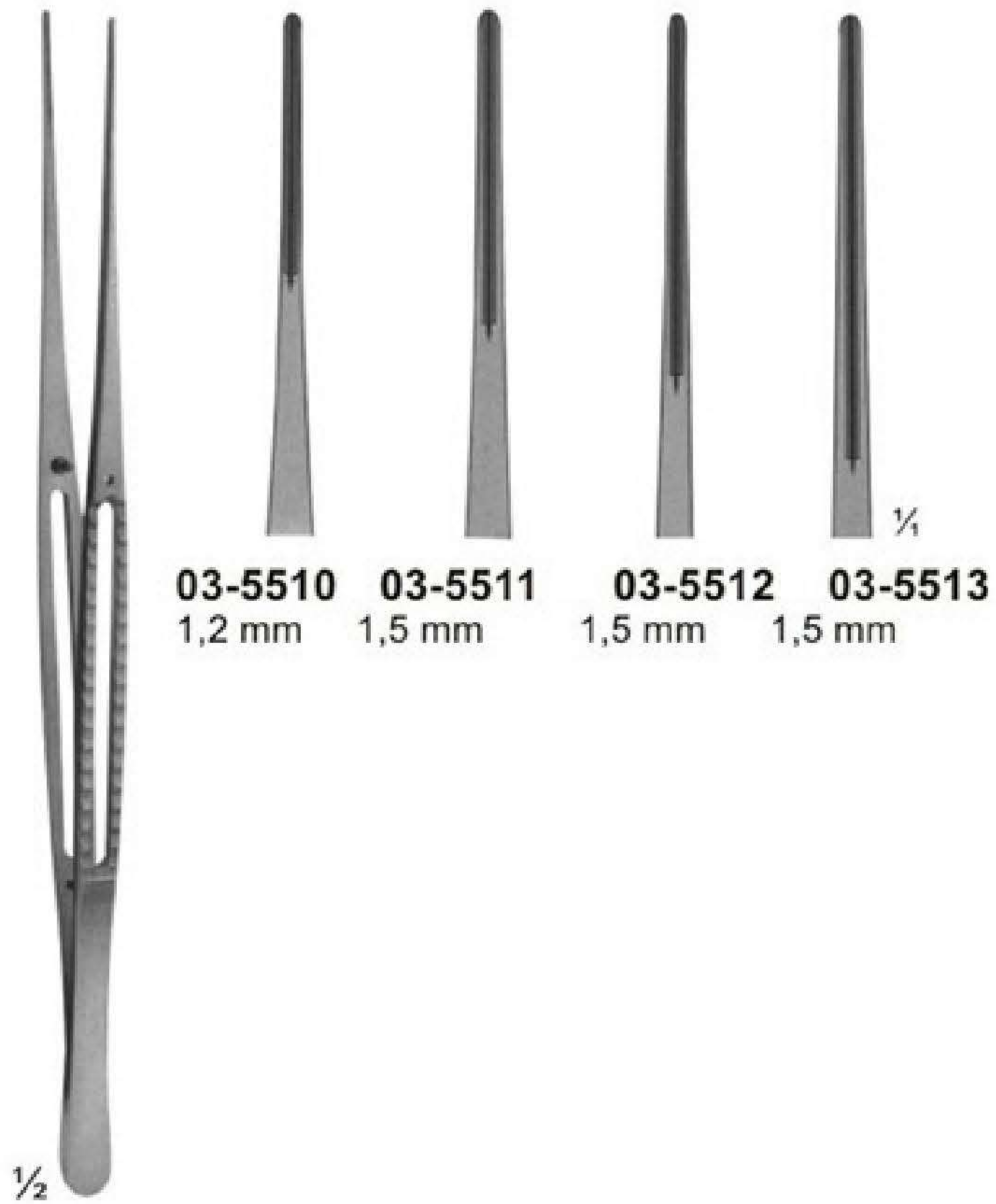

03-5510 - 03-5513
03-5510 150 mm
03-5511 200 mm
03-5512 240 mm
03-5513 300 mm



03-5514 - 03-5517
DE BAKEY
03-5514 150 mm
03-5515 200 mm
03-5516 240 mm
03-5517 300 mm

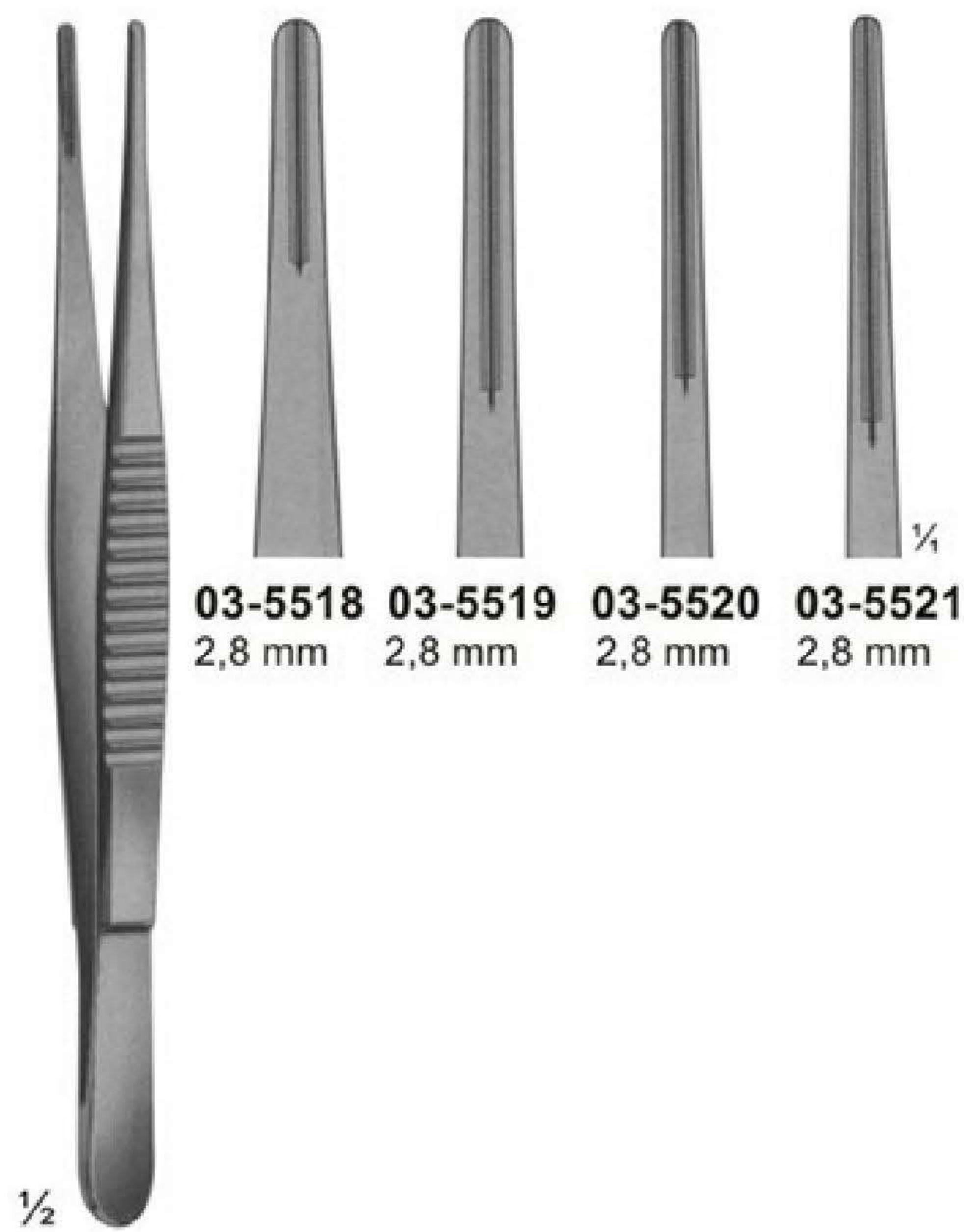

03-5518 - 03-5521
DE BAKEY
03-5518 150 mm
03-5519 200 mm
03-5520 240 mm
03-5521 300 mm

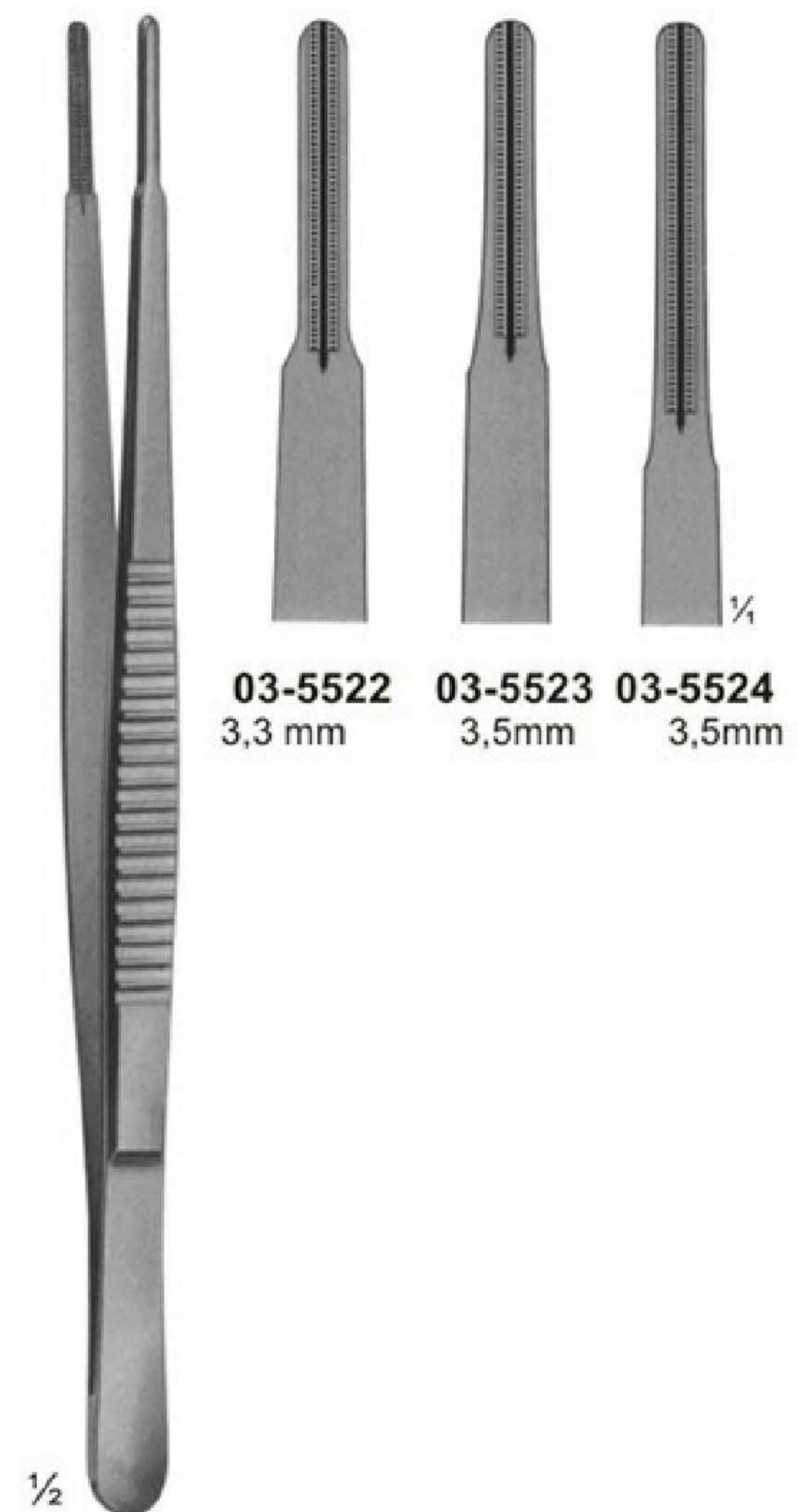

03-5522 - 03-5524
DE BAKEY
03-5522 200 mm
03-5523 240 mm
03-5524 300 mm

Intestinal Clamps for Children



03-5525 - 03-5526
 BAINBRIDGE
 155 mm

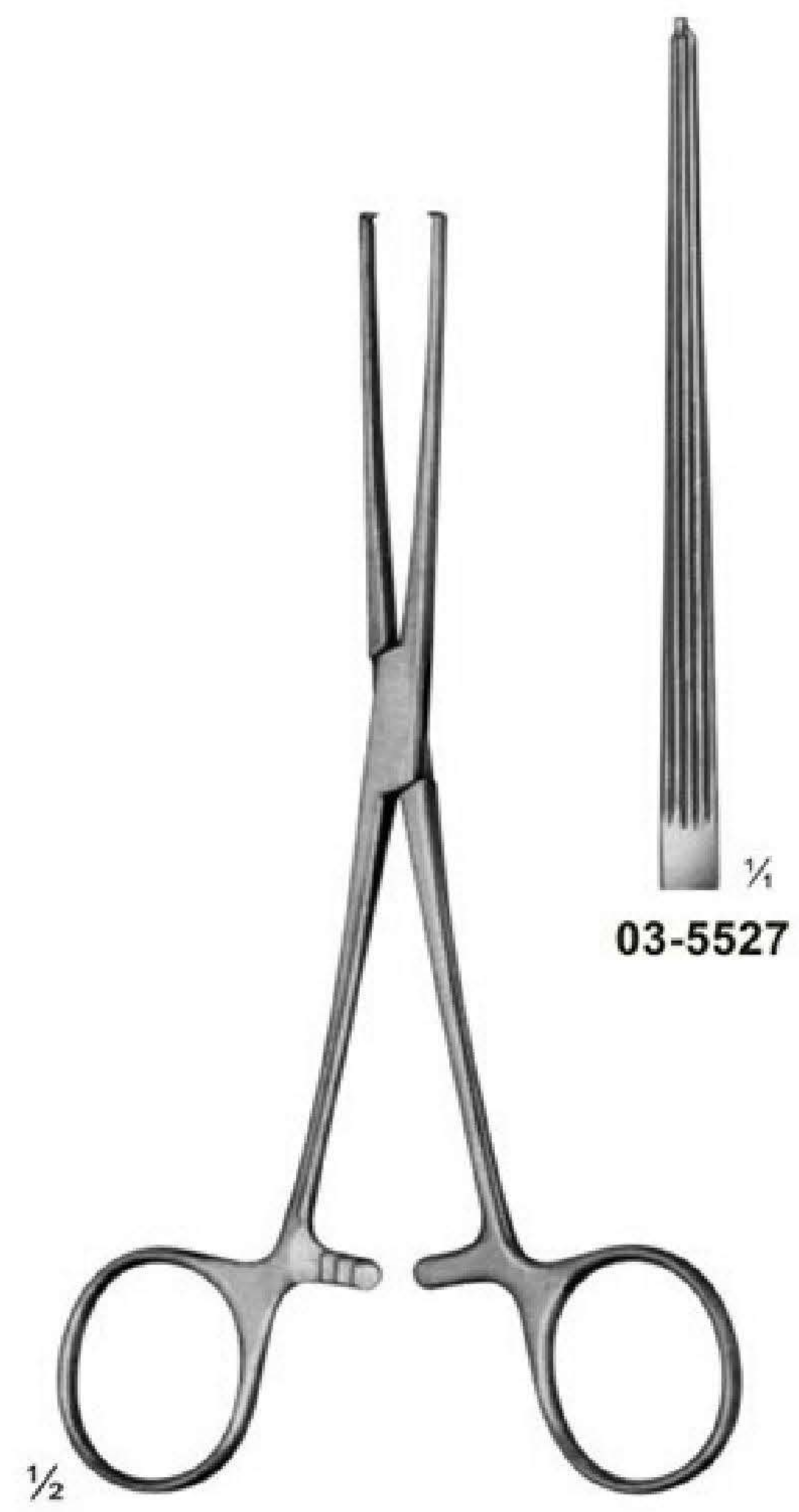

03-5527
 ALLEN
 155 mm

Atraumata



03-5528 - 03-5529
 BABY-KOCHER
 very elastic blades
 130 mm

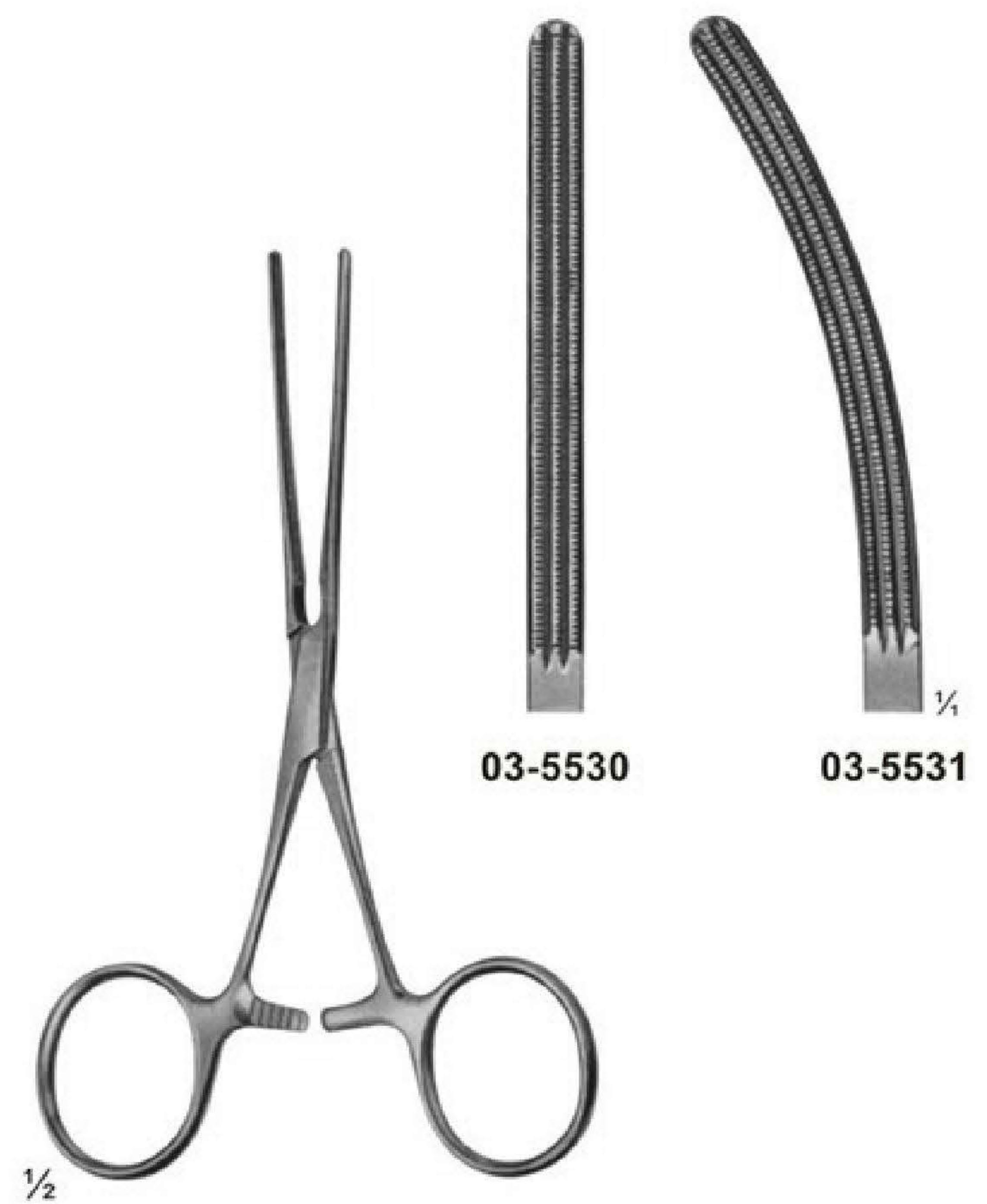

03-5530 - 03-5531
 BABY-KOCHER
 with elastic blades
 130 mm

Intestinal Clamps, Soft Elastic

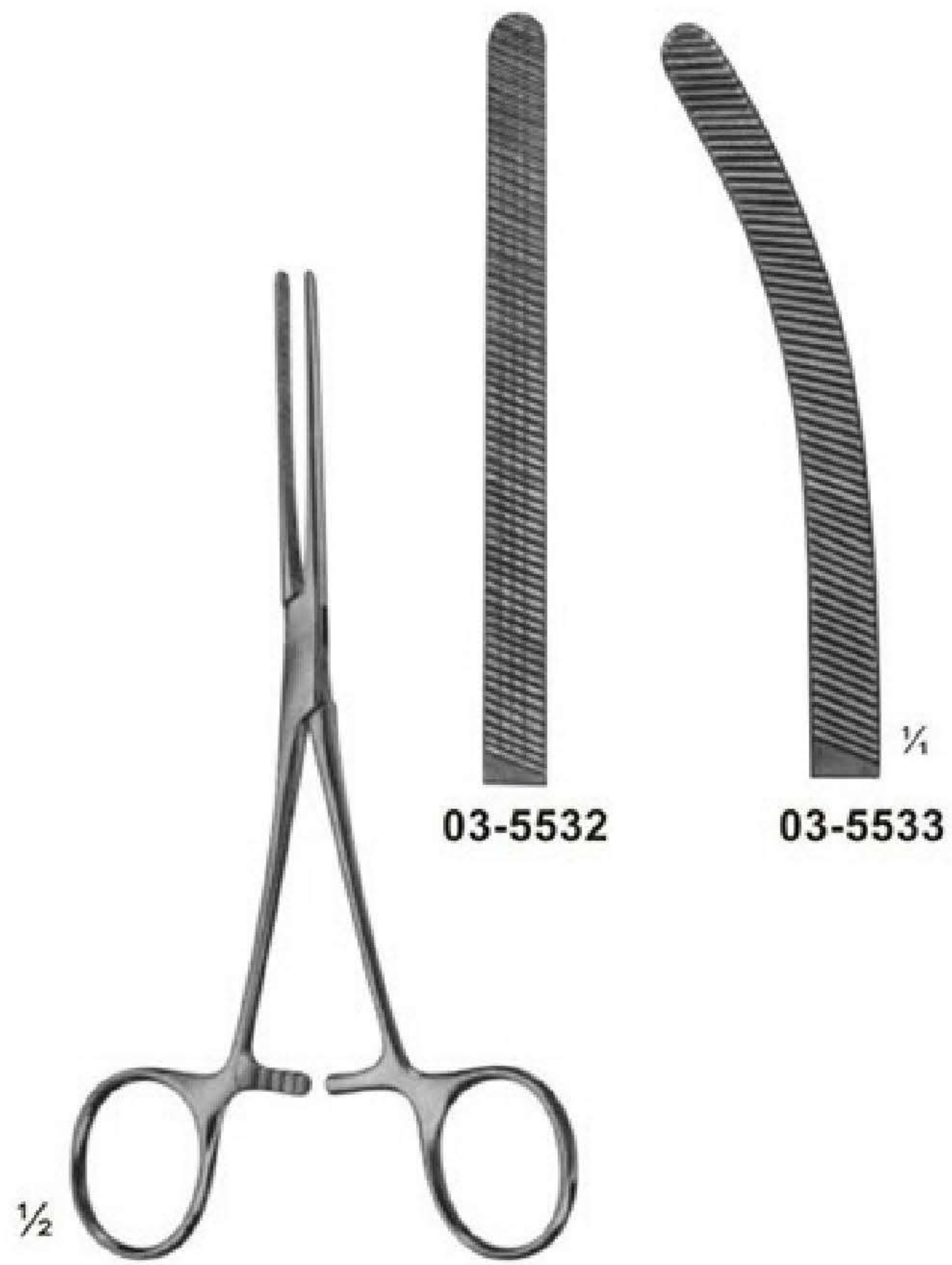

03-5532 - 03-5533
 DOYEN
 elastic
 165 mm

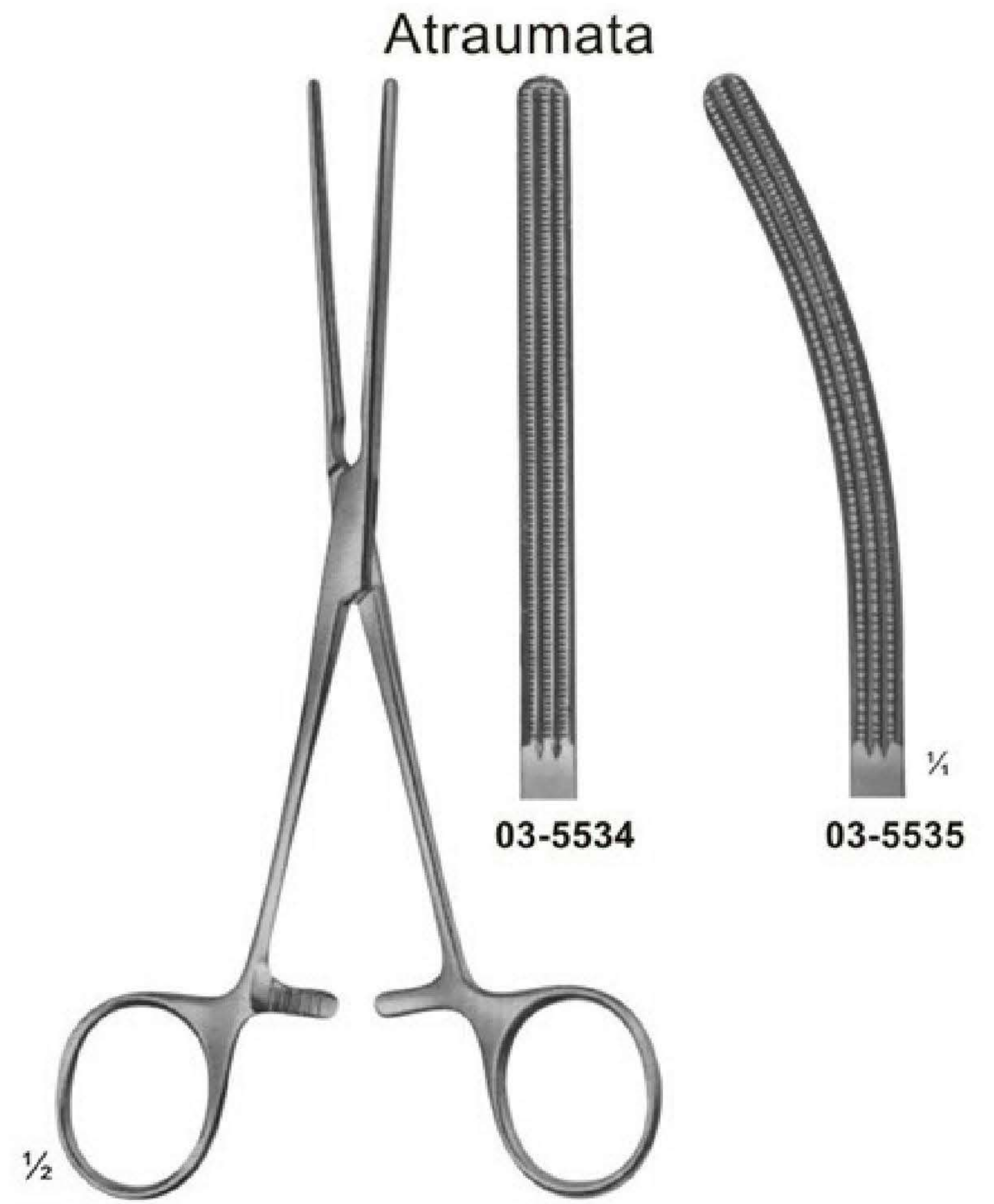

03-5534 - 03-5535
 DOYEN
 with elastic blades
 170 mm



03-5536 - 03-5537
 HARTMANN
 with elastic blades
 200 mm



03-5538 - 03-5539
 HARTMANN
 with elastic blades
 200 mm

Intestinal Clamps, Soft elastic

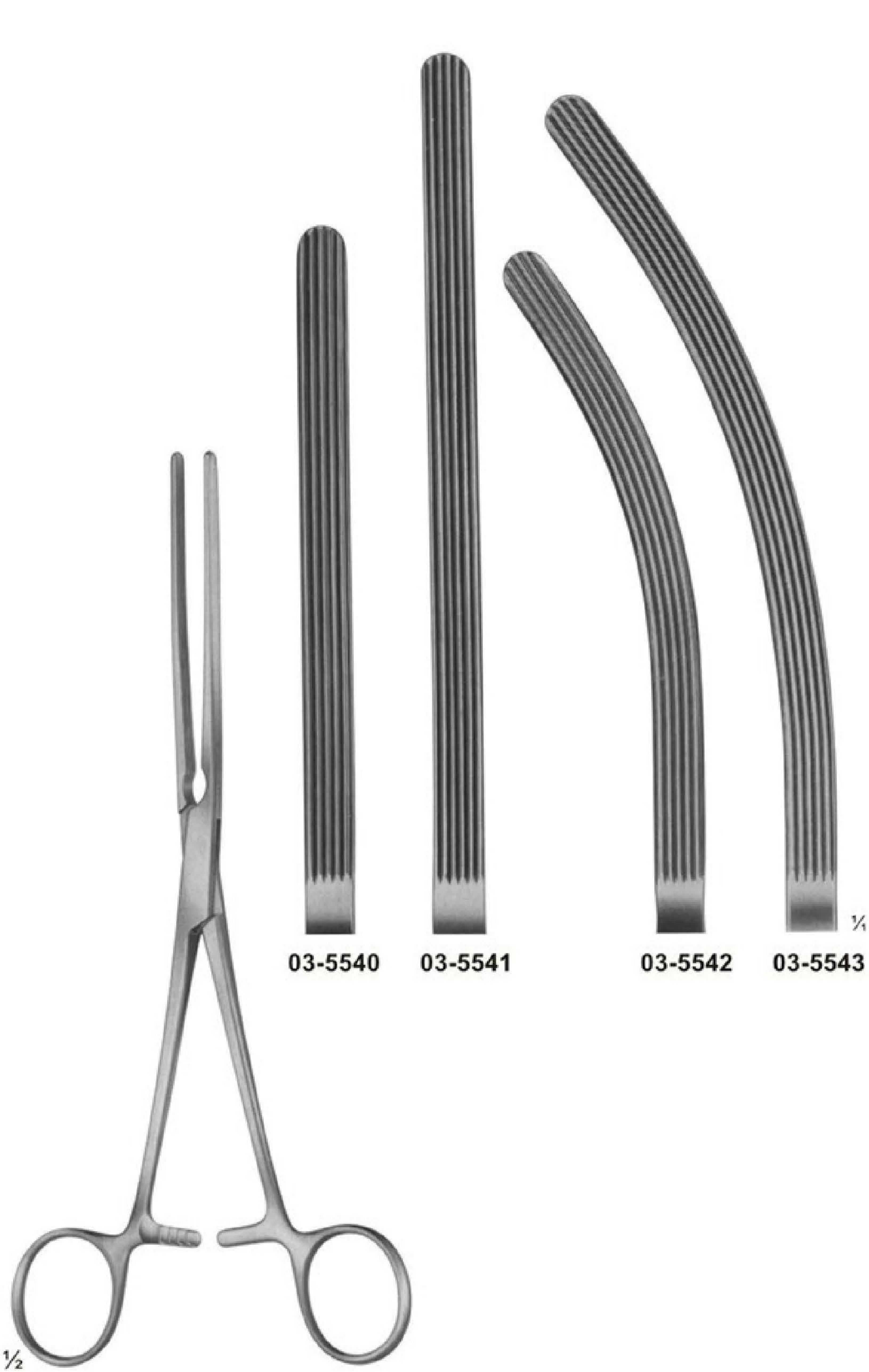

03-5540 - 03-5543
 KOCHER
 with elastic blades
03-5540-03-5542 210 mm
03-5541-03-5543 230 mm



03-5544 - 03-5545
 DOYEN
 with elastic blades
 240 mm

Intestinal Clamps, Soft elastic

Atraumata

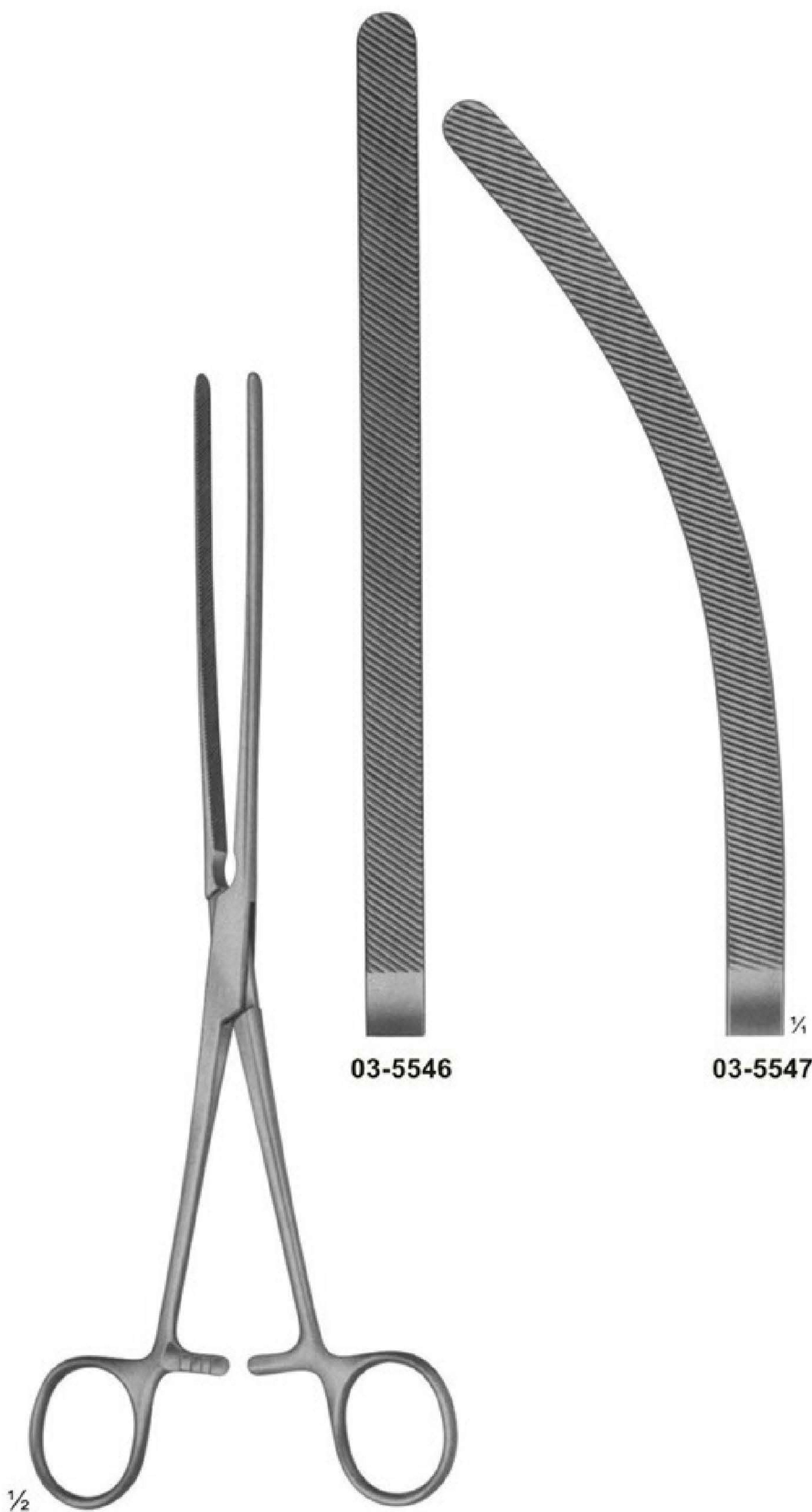

03-5546

03-5547

1/2

03-5546 - 03-5547
 DOYEN
 with elastic blades
 235 mm

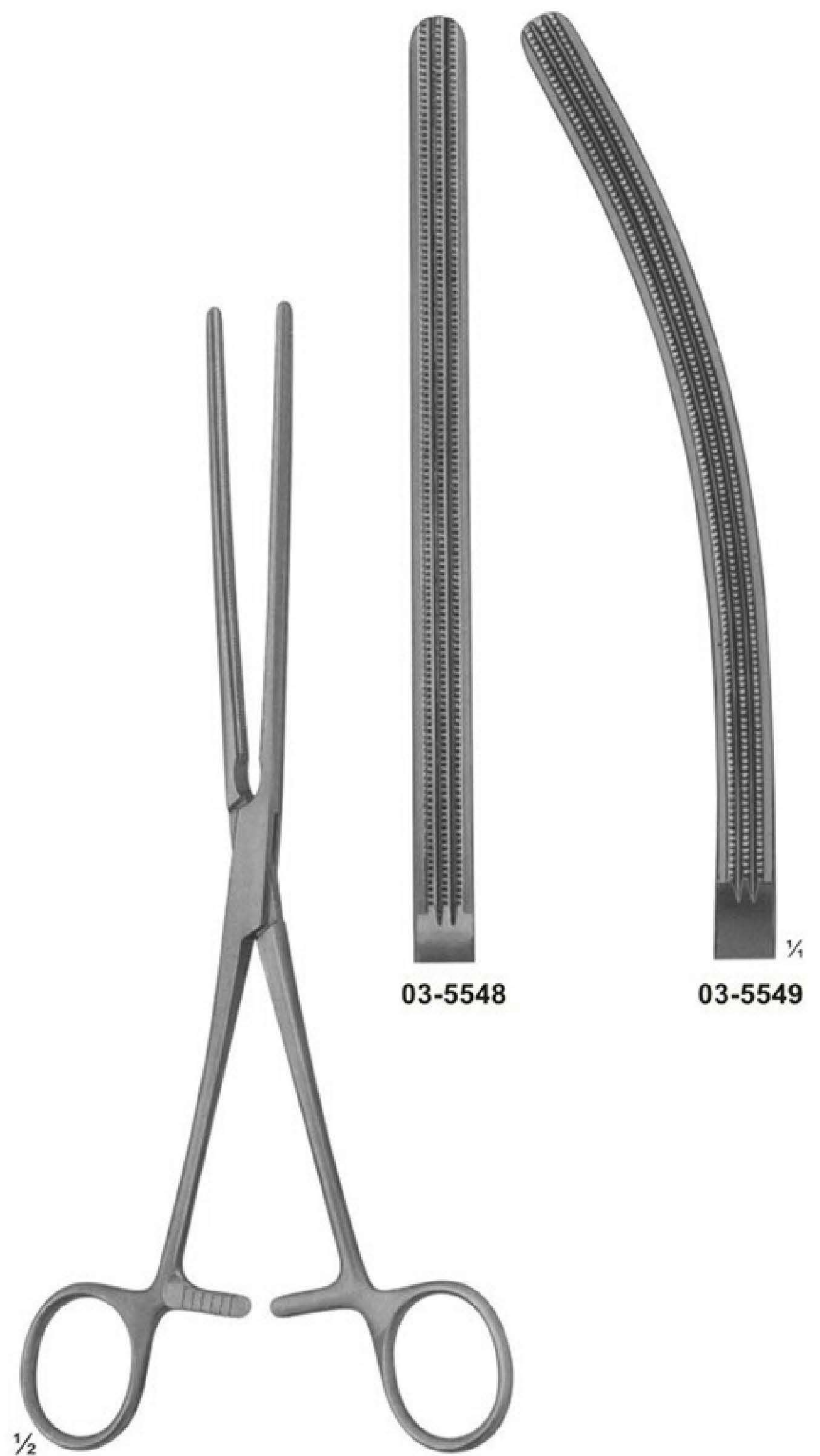

03-5548

03-5549

1/2

03-5548 - 03-5549
 DOYEN
 with elastic blades
 230 mm

Intestinal Clamps, Soft elastic

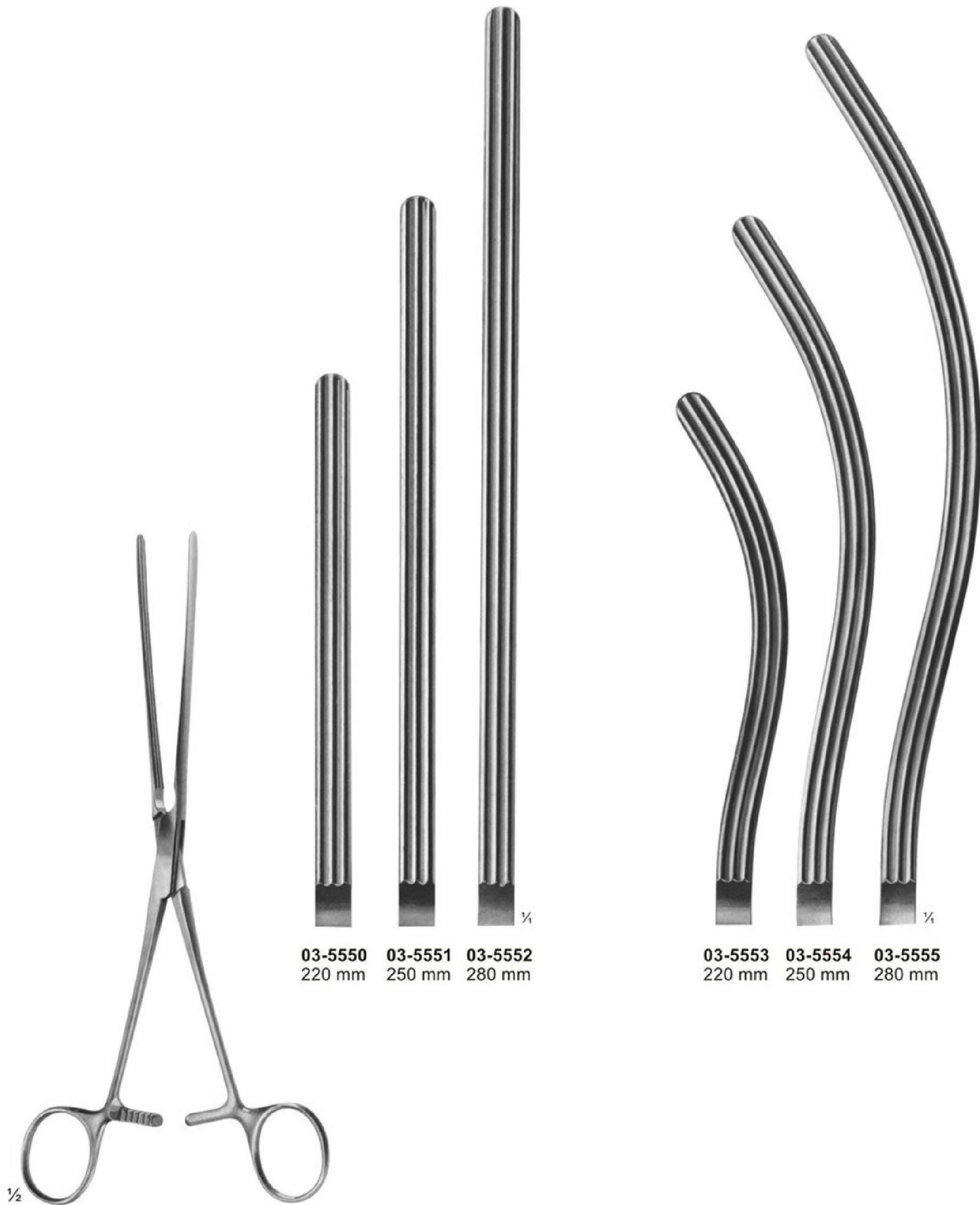

03-5550 220 mm
03-5551 250 mm
03-5552 280 mm

03-5553 220 mm
03-5554 250 mm
03-5555 280 mm

03-5550 - 03-5555
 KOCHER
 with very elastic blades

Intestinal Clamps, Soft elastic

Atraumata

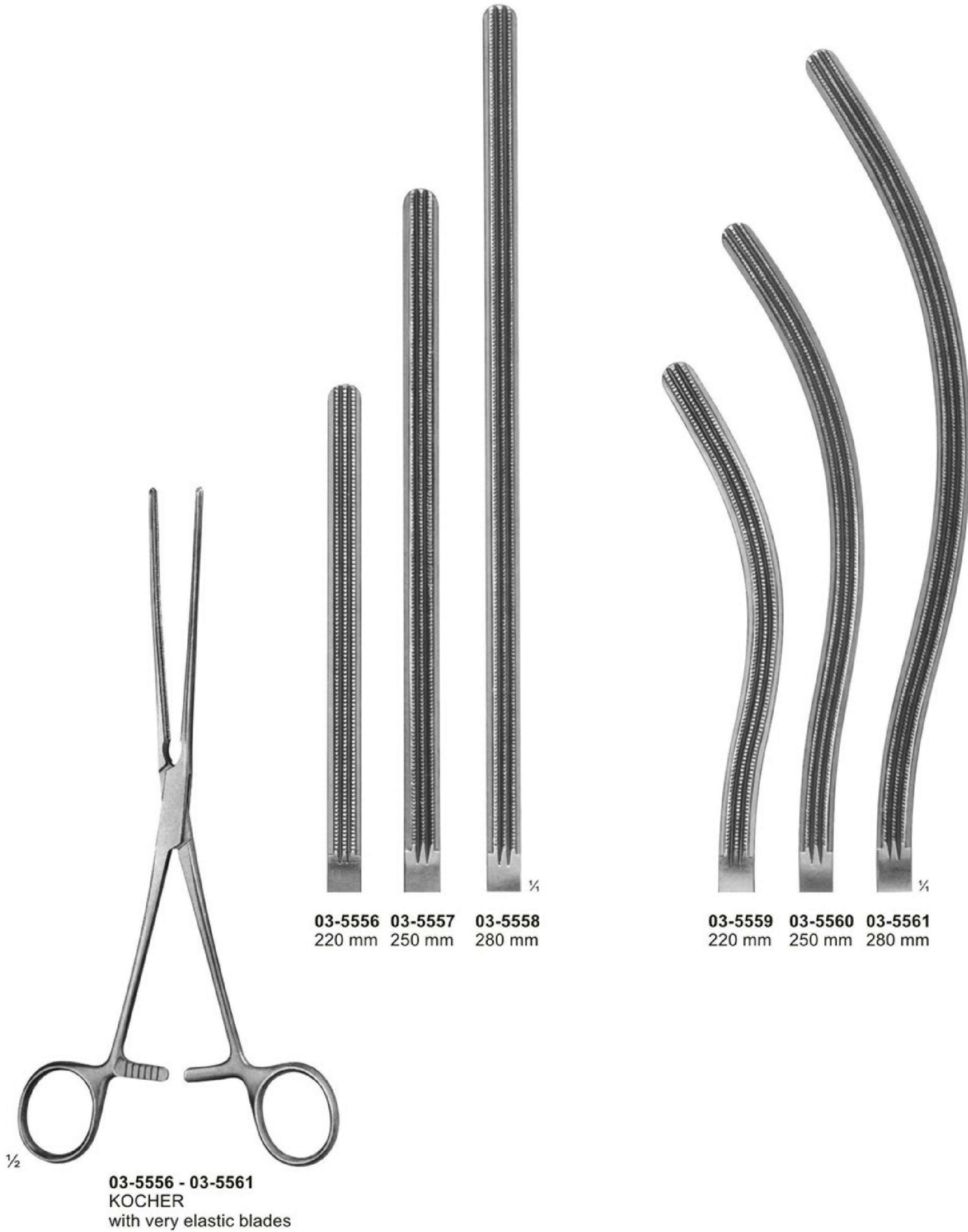

1/2

03-5556 - 03-5561
 KOCHER
 with very elastic blades

03-5556 03-5557 03-5558
 220 mm 250 mm 280 mm

03-5559 03-5560 03-5561
 220 mm 250 mm 280 mm

Intestinal Clamps

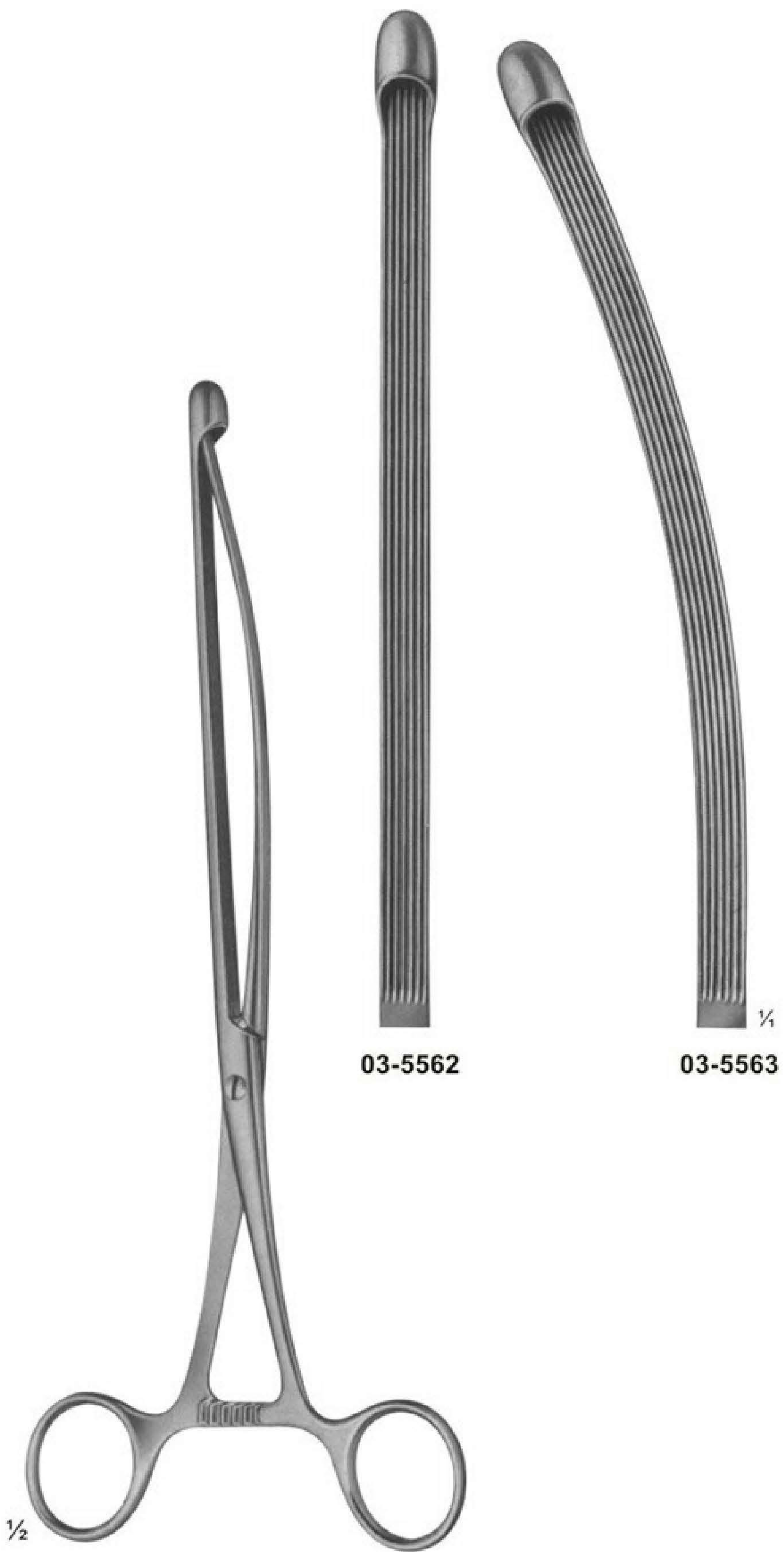

03-5562 - 03-5563
 NUSSBAUM
 with elastic blades
 250 mm

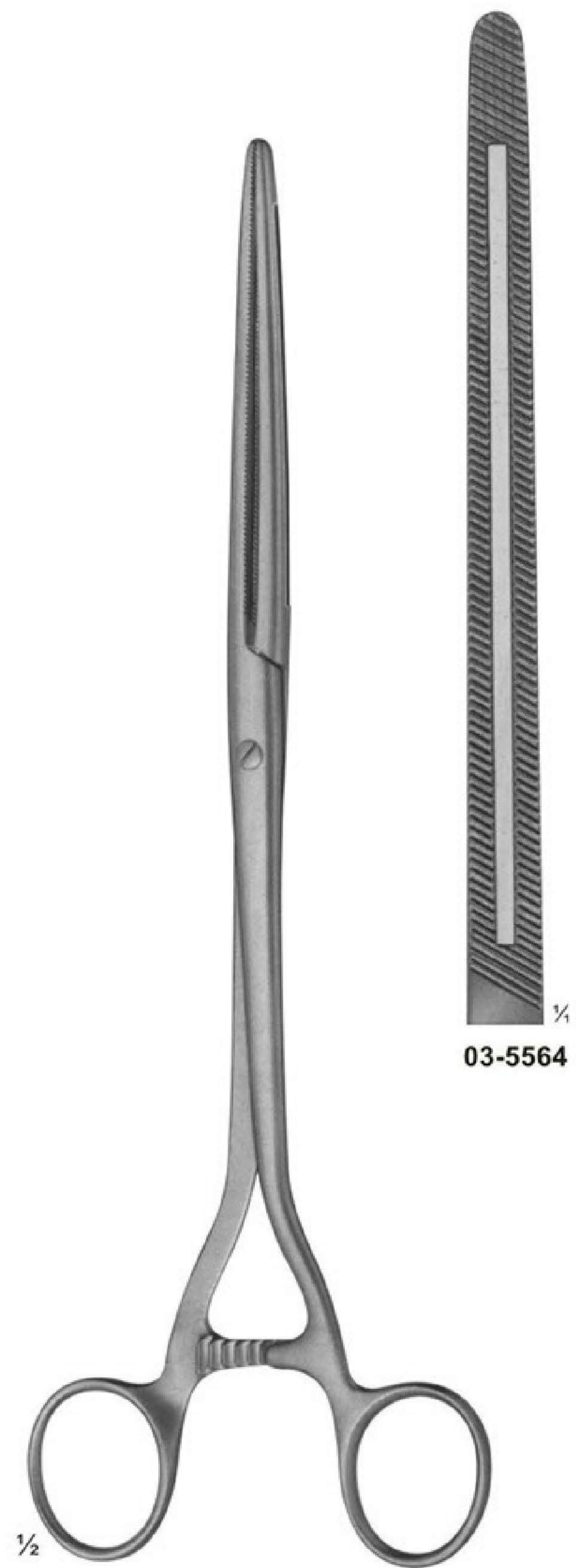

03-5564
 MOYNIHAN
 280 mm

Intestinal Clamps

Atraumata

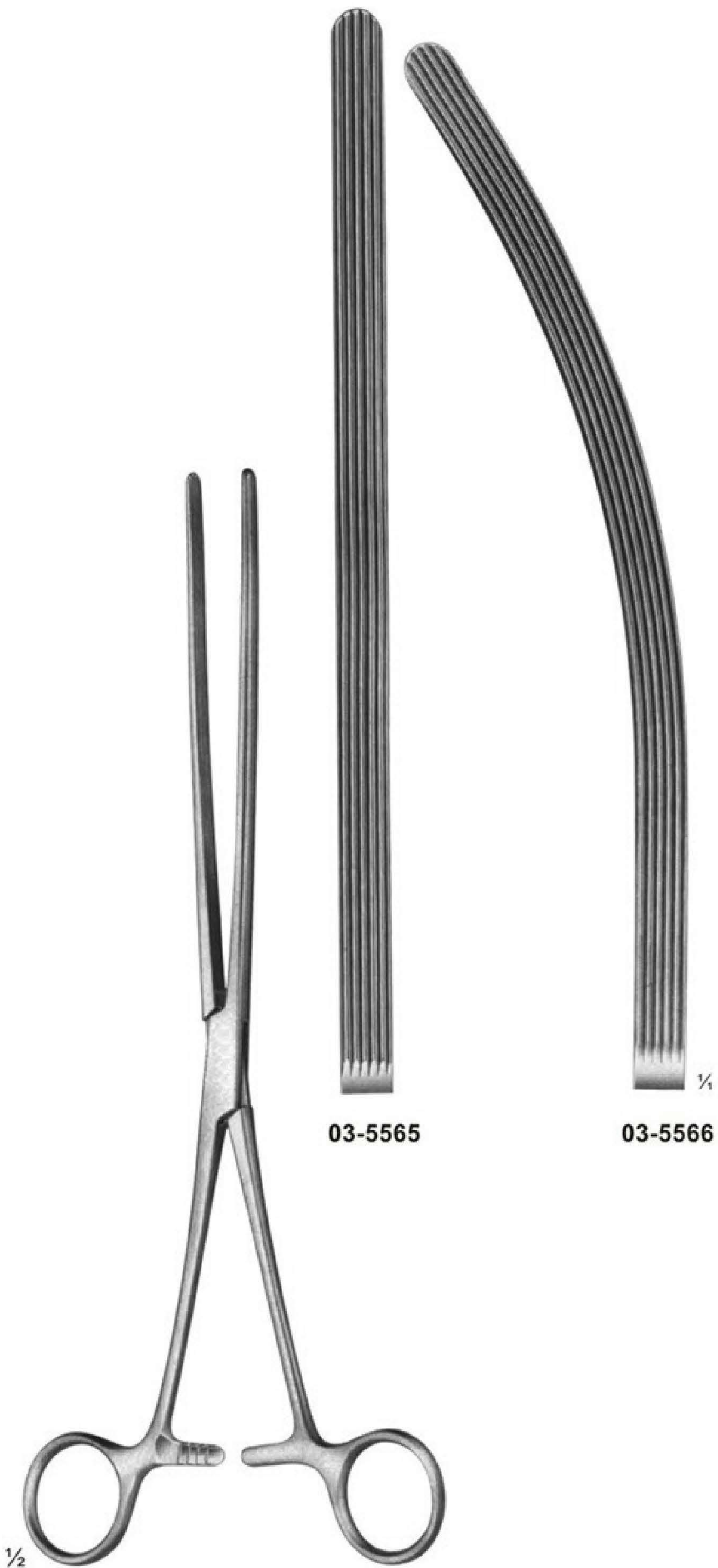

03-5565

03-5566

03-5565 - 03-5566
 MAYO-ROBSON
 hard elastic
 250 mm

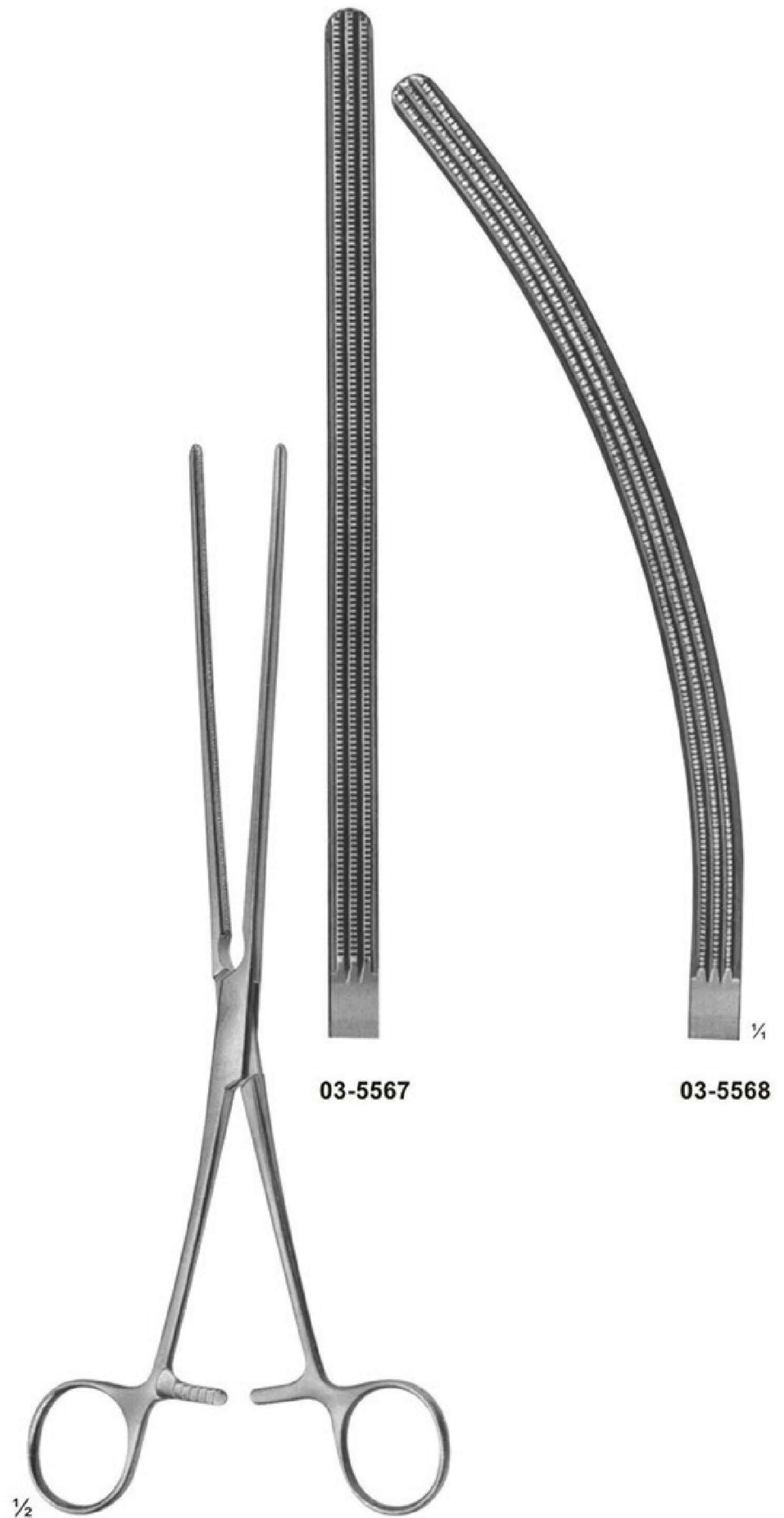

03-5567

03-5568

03-5567 - 03-5568
 MAYO-ROBSON
 250 mm

Gastro-Intestinal Forceps, twin



03-5569
LANE
300 mm

03-5570
LANE
300 mm

Stomach Clamps

Atraumata

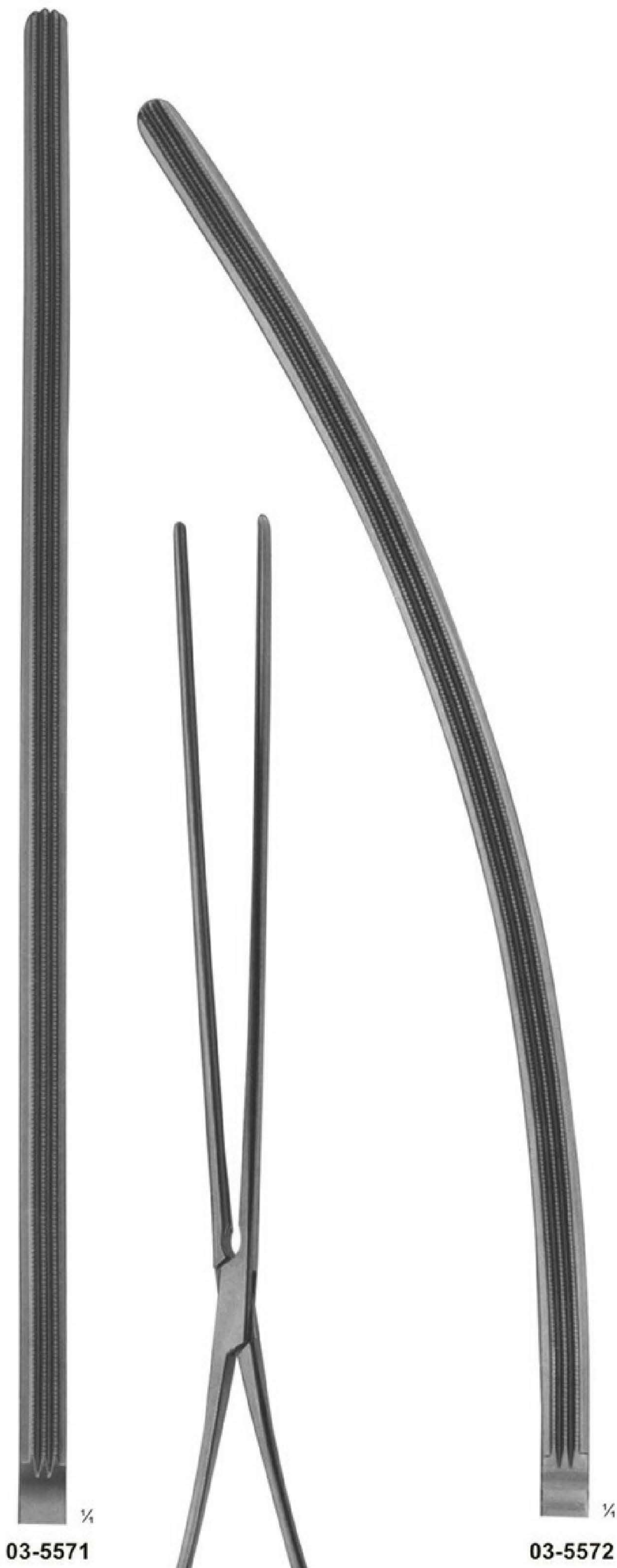

03-5571 $\frac{1}{4}$

03-5572 $\frac{1}{4}$

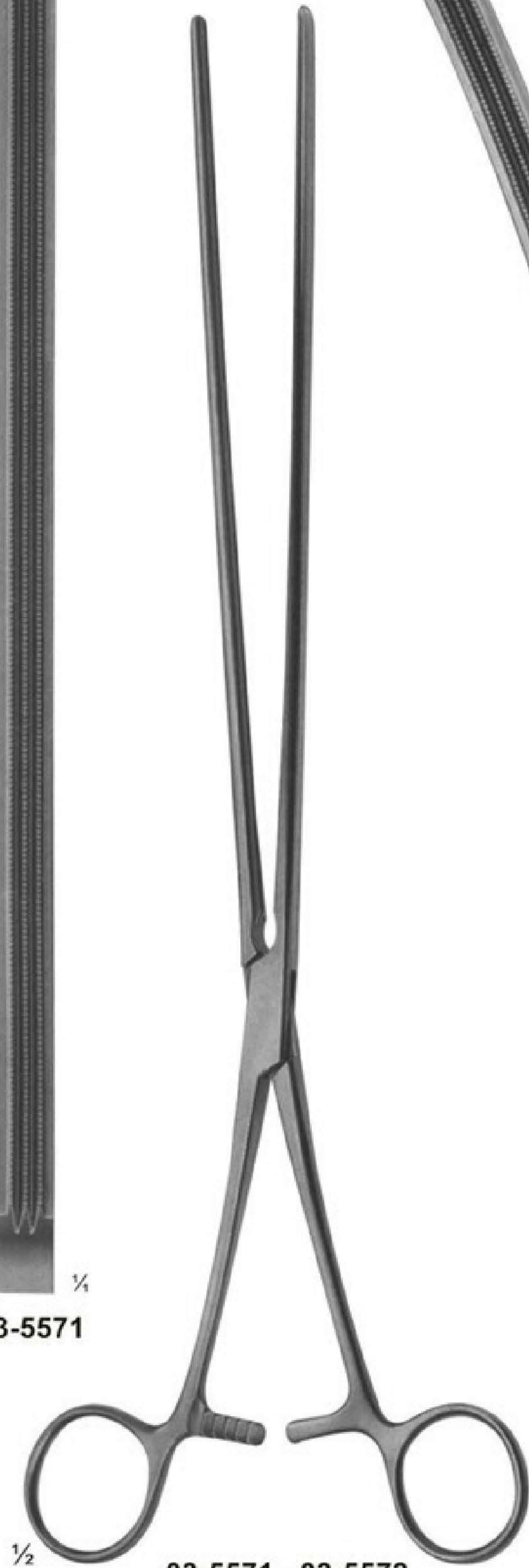

$\frac{1}{2}$ 03-5571 - 03-5572
 SCUDDER
 330 mm



$\frac{1}{2}$ 03-5573
 KLEINSCHMIDT
 Spur crushers and
 Appendectomy clamps
 130 mm

Intestinal and Pylorus Clamps



$\frac{1}{2}$
03-5574
 PAYR
 Intestinal clamp
 light pattern,
 for children
 180 mm

$\frac{1}{2}$
03-5575
 PAYR
 200 mm

$\frac{1}{2}$
03-5576
 PAYR
 275 mm

$\frac{1}{2}$
03-5577
 PAYR
 Pylorus clamp
 315 mm

Anastomosis Forceps

Atraumata



03-5578
PARKER-KERR
anastomosis forceps
for colon resection
250 mm



03-5579 - 03-5581
DICK
pressure clamps

Sigmoid Anastomosis Forceps



Atraumata Sigmoid Anastomosis Forceps

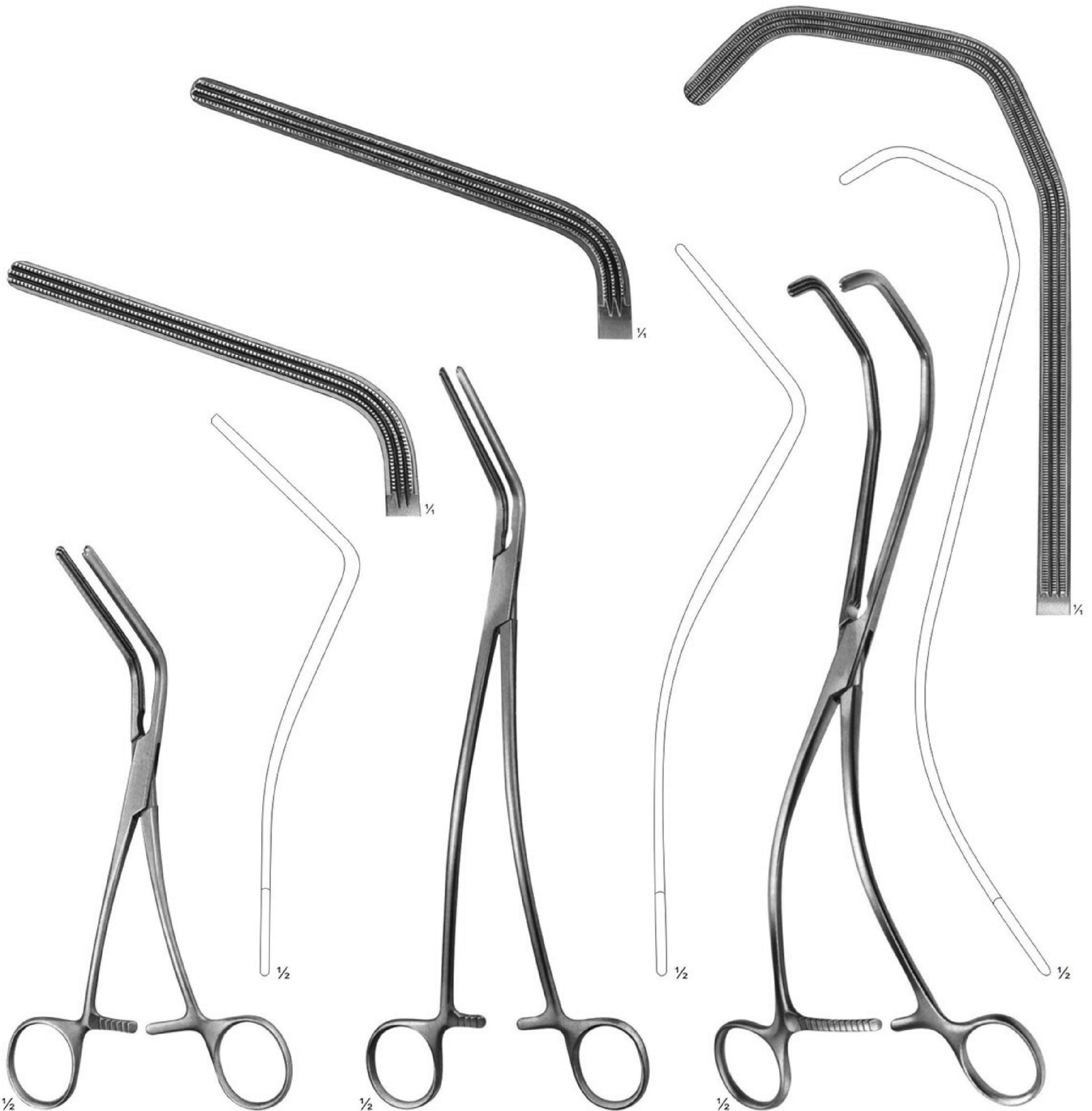

03-5585
 MORRIS
 175 mm

03-5586
 DE BAKEY
 (MORRIS modif.)
 240 mm

03-5587
 KERSTING
 270 mm

Rectal Specula

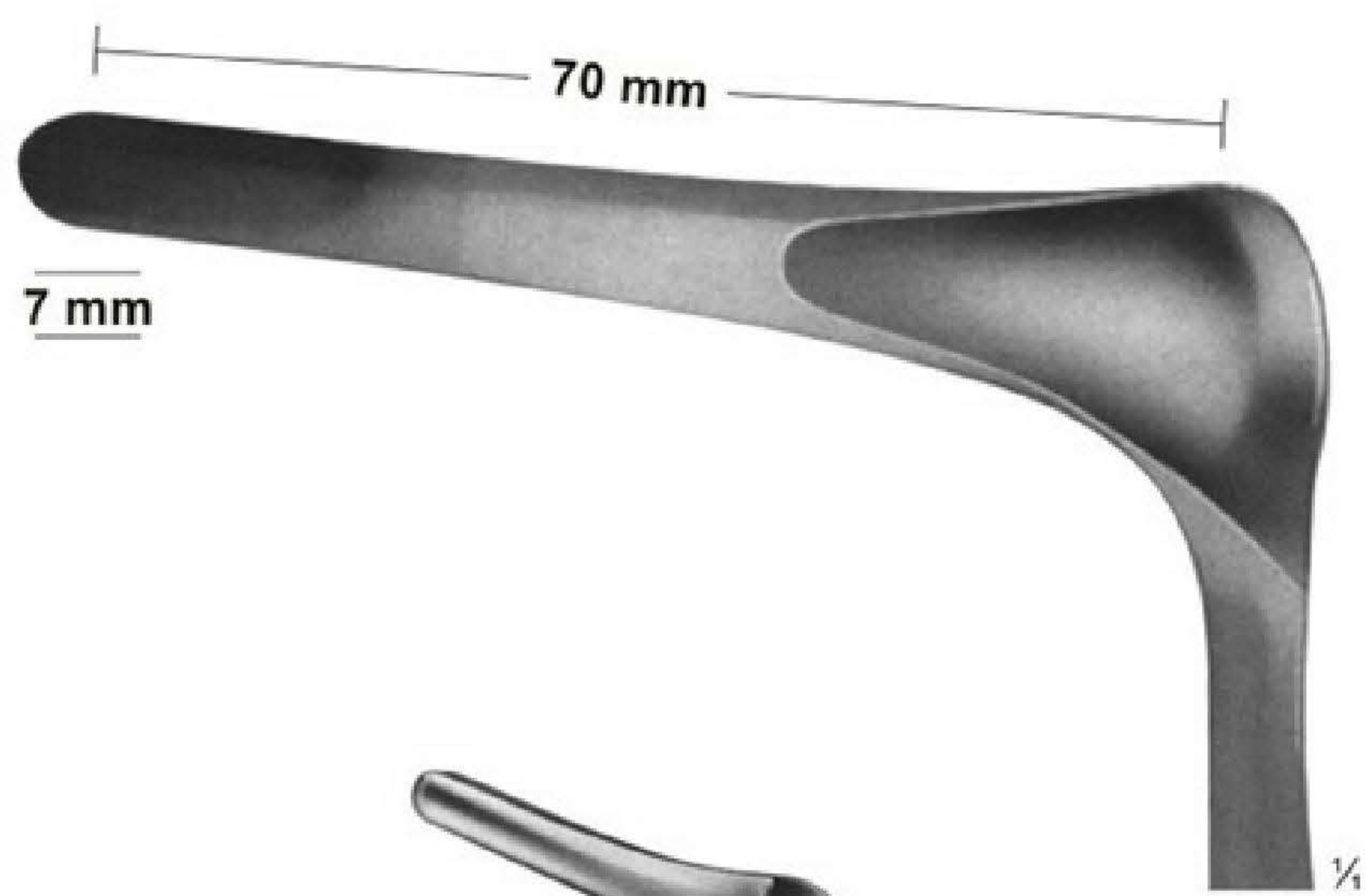

03-5588
KILLIAN
for children
145 mm



03-5589
SIMS
160 mm



03-5590
SIMS
160 mm

Rectal Specula



1/2

03-5591 - 03-5594

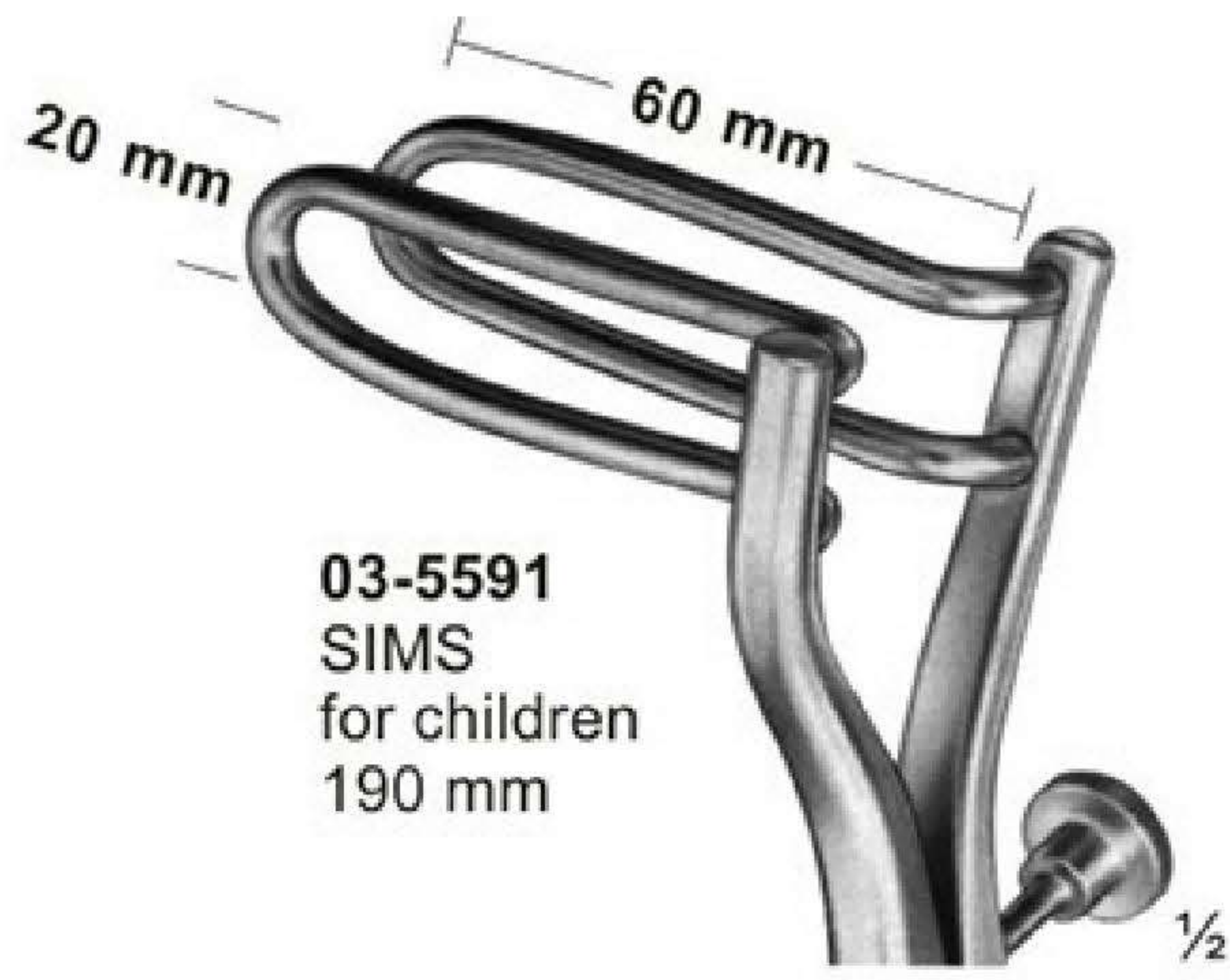

03-5591
 SIMS
 for children
 190 mm

1/2

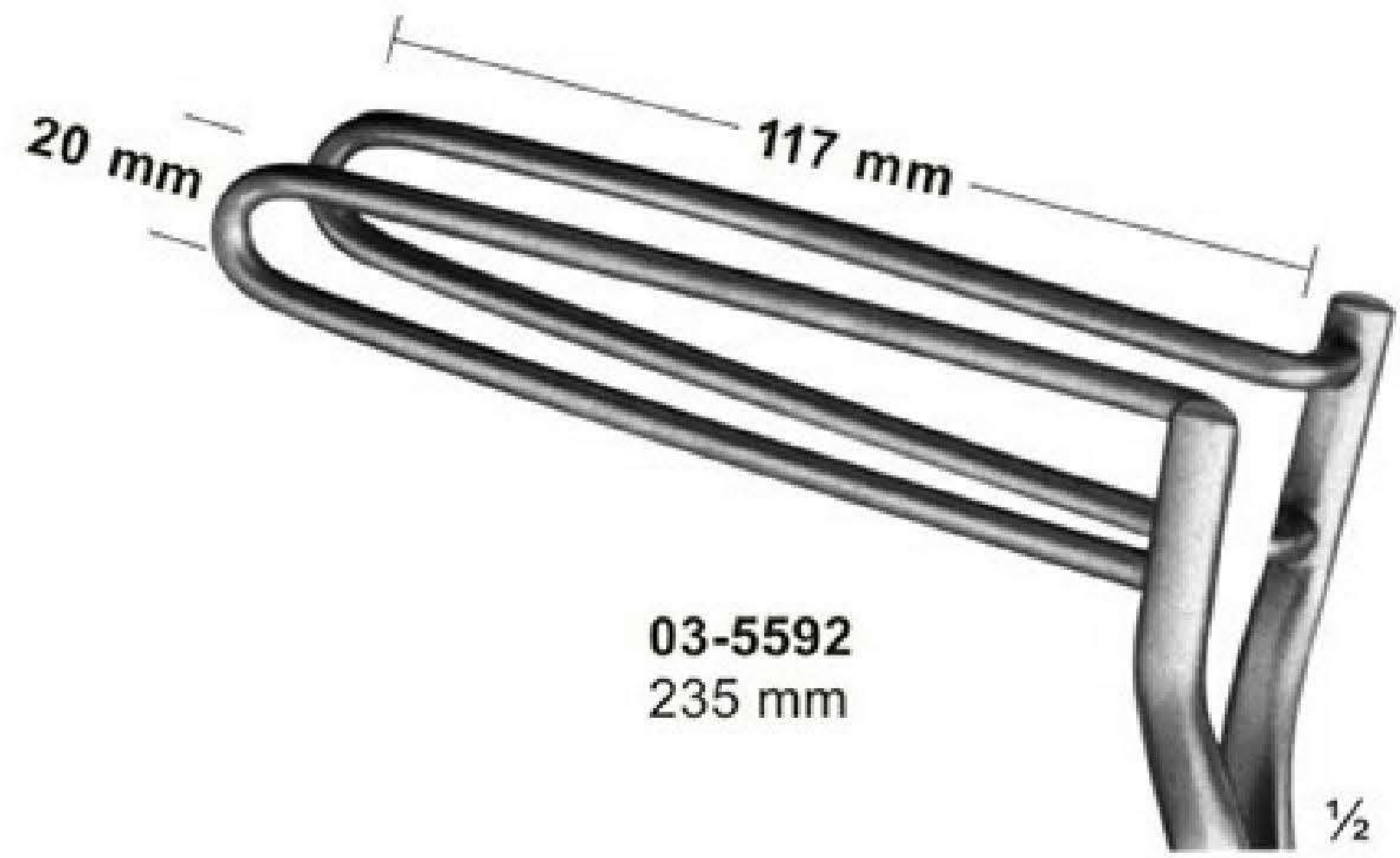

03-5592
 235 mm

1/2



03-5593
 SIMS
 for adults
 235 mm

1/2

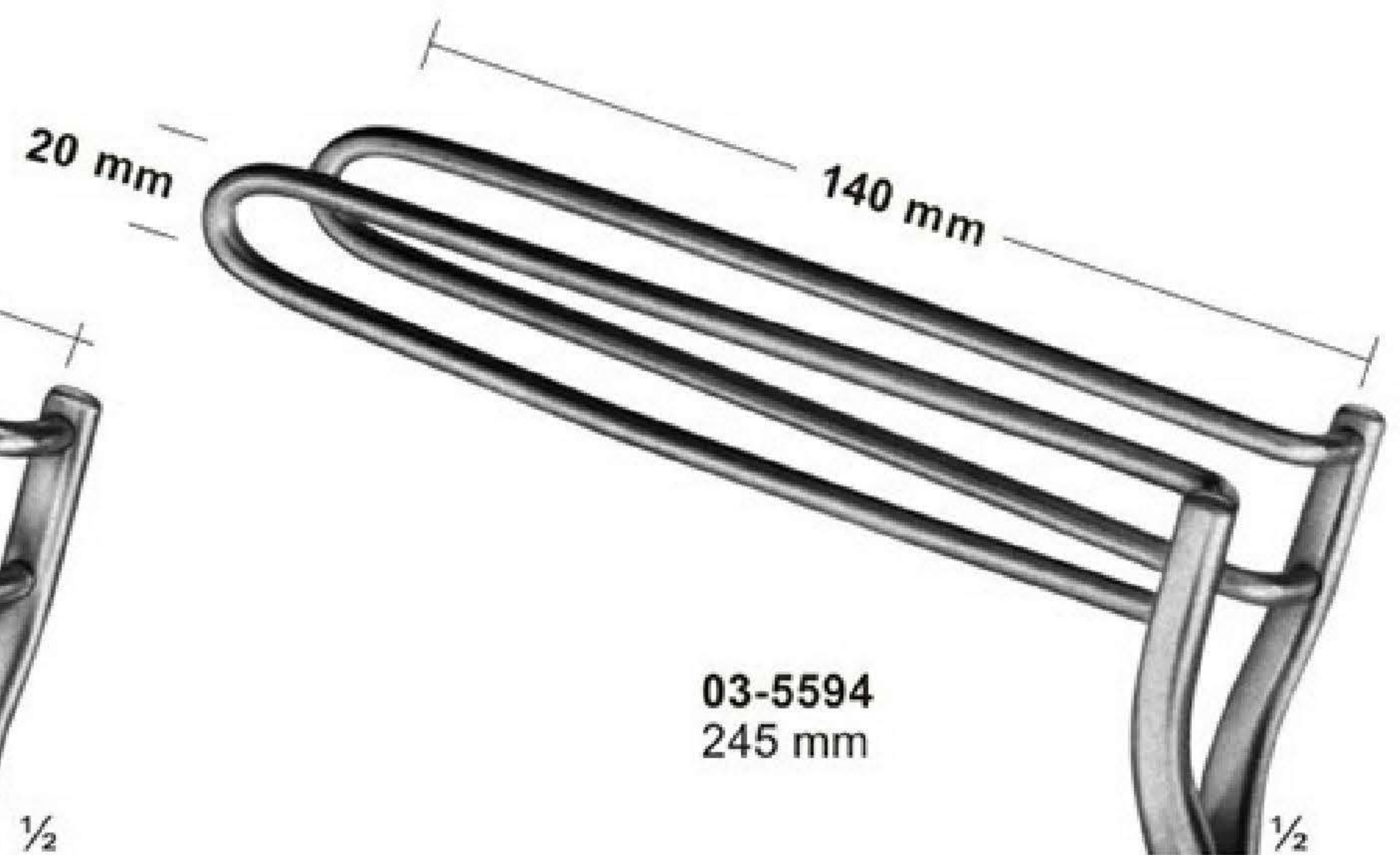

03-5594
 245 mm

1/2



1/2

03-5595
 PRATT
 205 mm

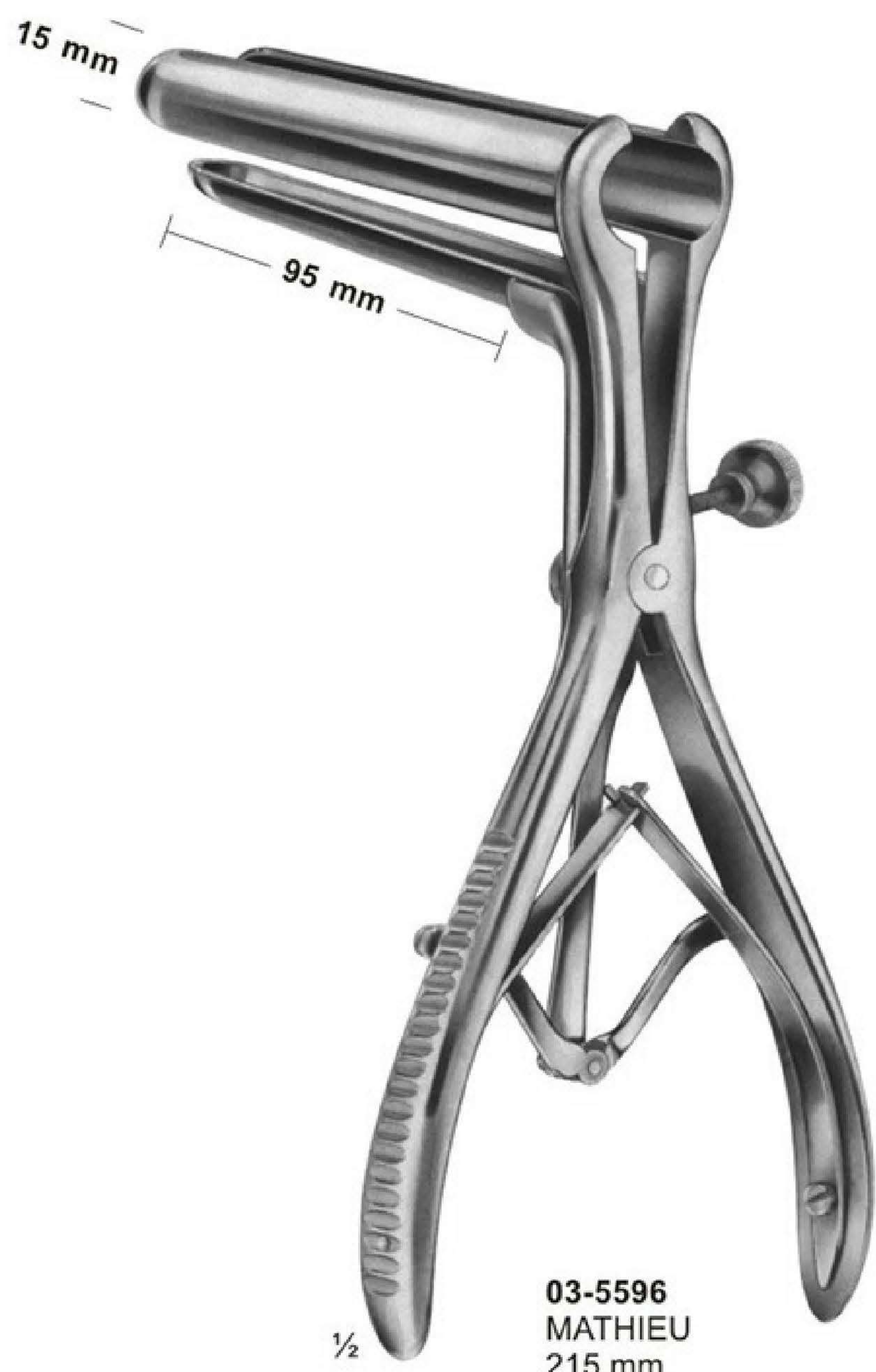

1/2

03-5596
 MATHIEU
 215 mm

Anuscopes-Sphincteroscopes, Proctoscopes

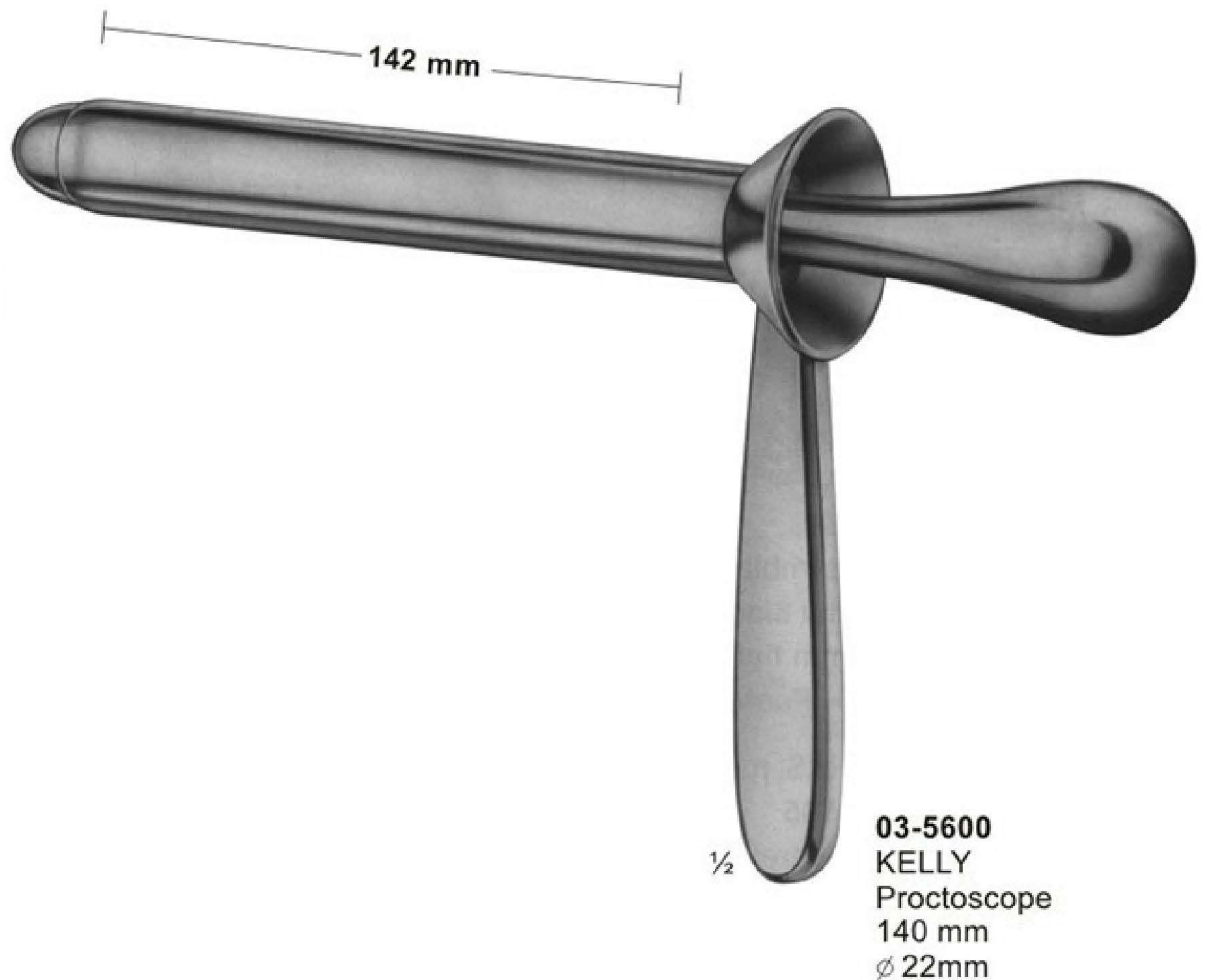
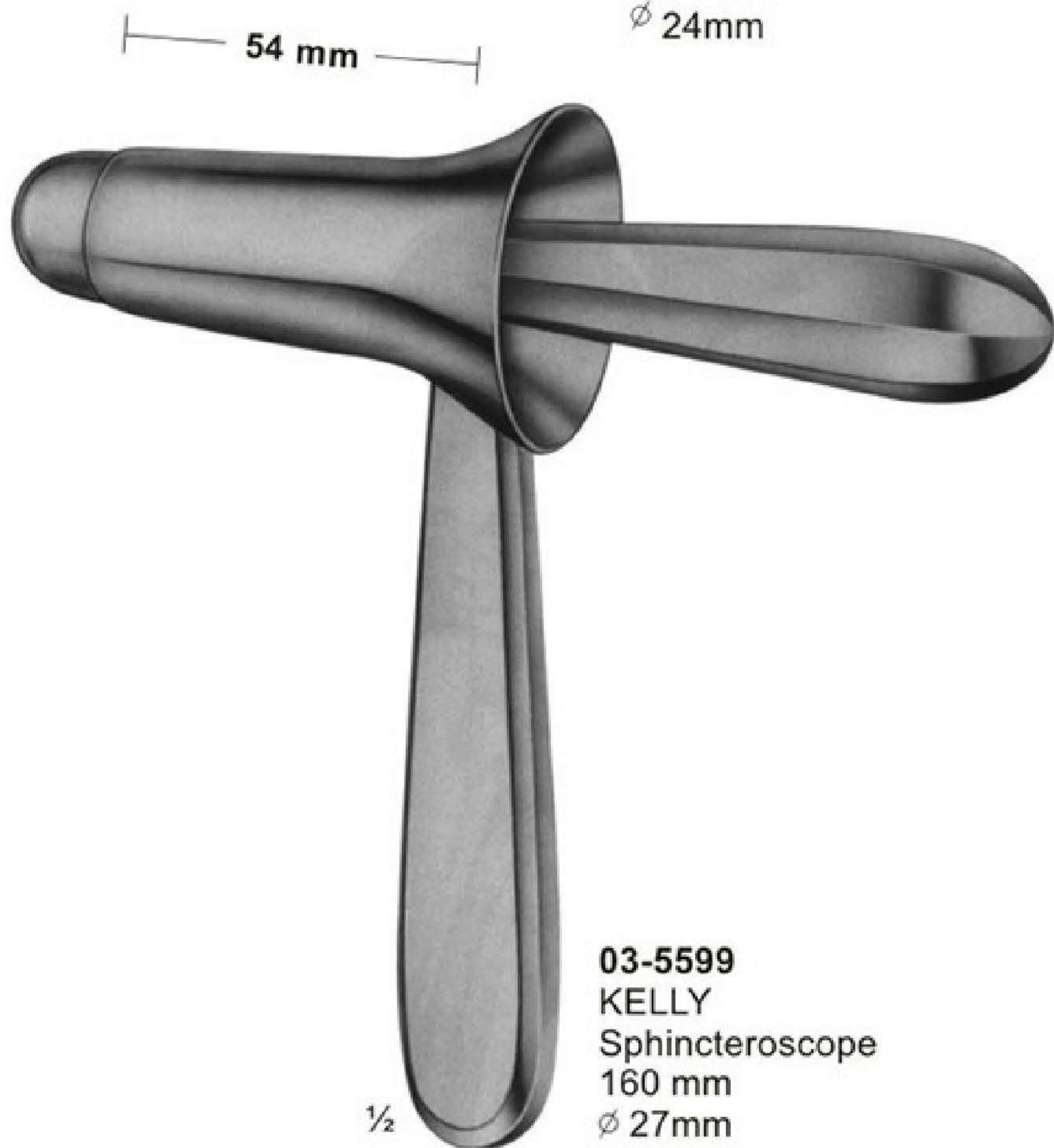

Biopsy forceps for rectum

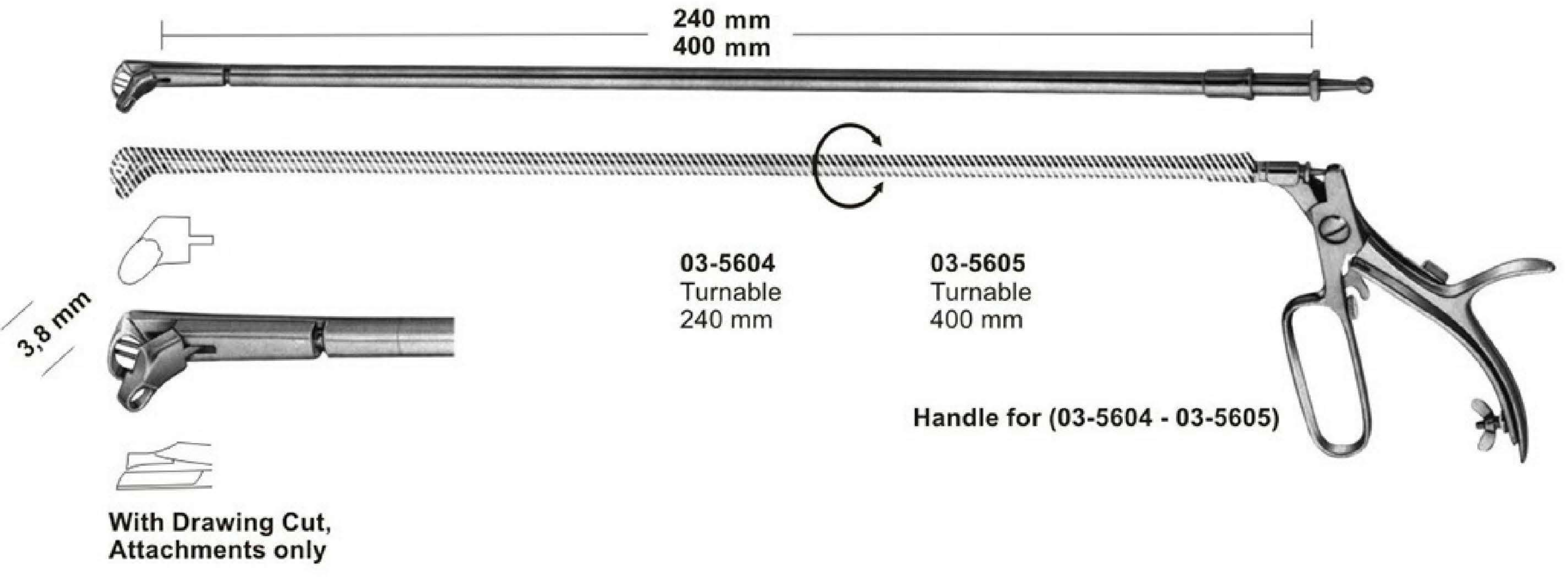
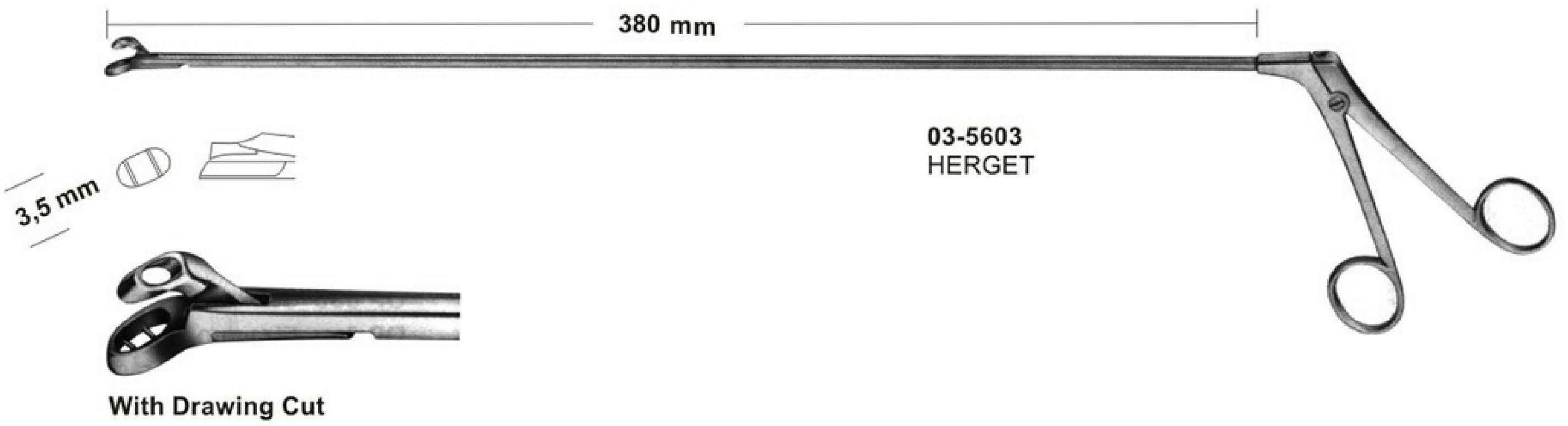
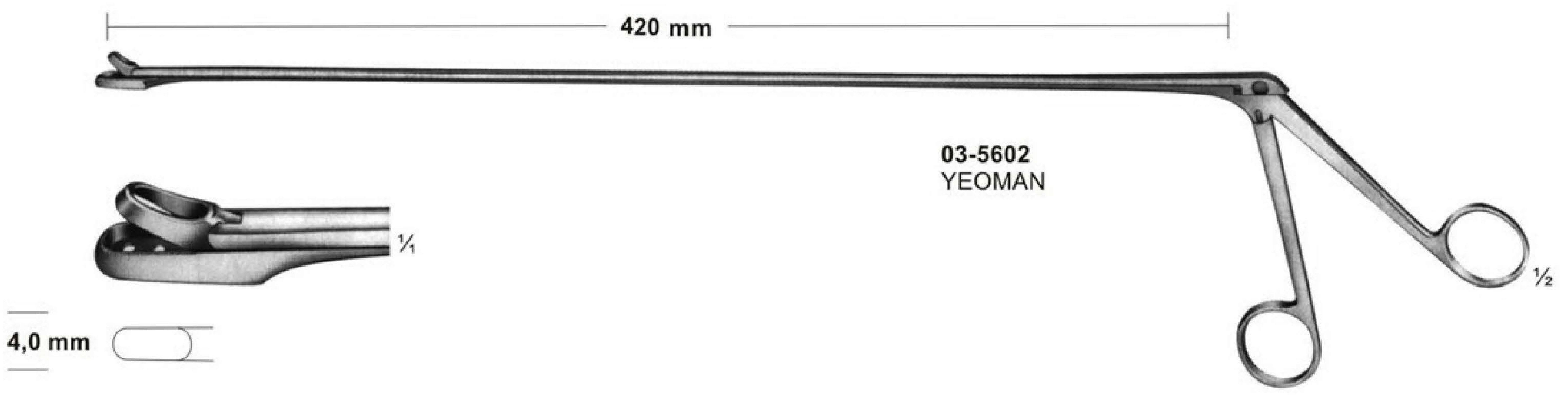
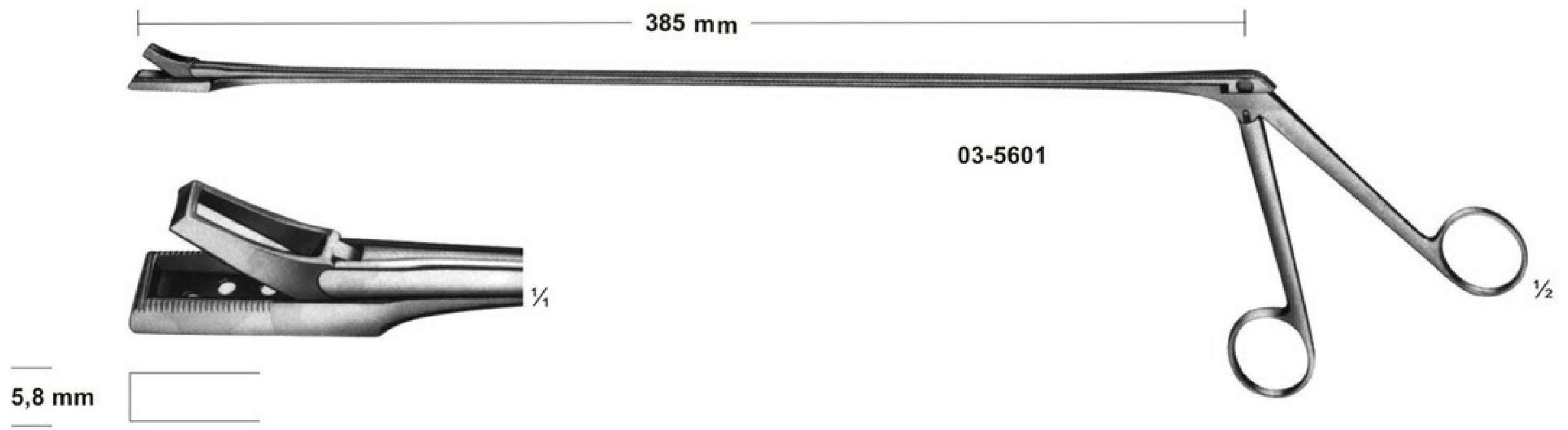

Biopsy Forceps & Swab Holders

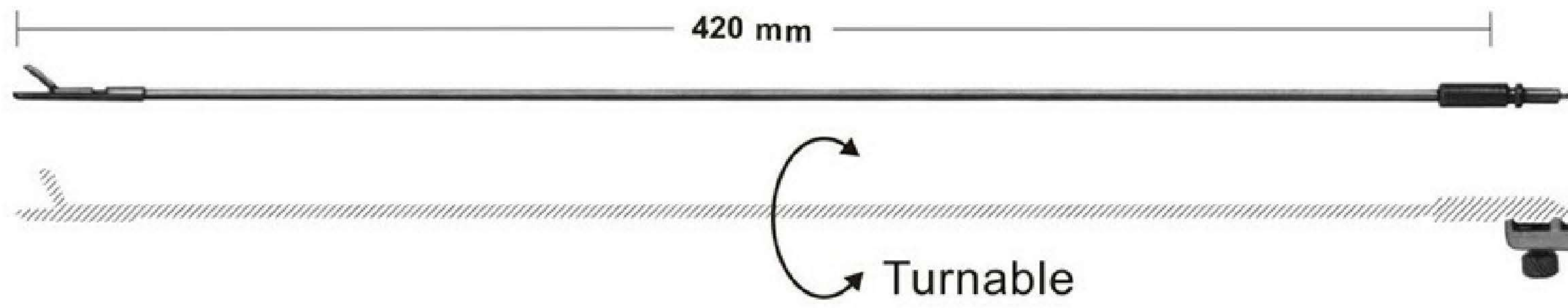

3,5 mm   ¼ 03-5606

3,5 mm   ¼ 03-5607

4,0 mm   ¼ 03-5608

4,0 mm   ¼ 03-5609

Biopsy Forceps

03-5606 - 03-5609
Handle for



3,5 mm   ¼

03-5610 - 03-5611
Biopsy Forceps, spoon-shaped
oval jaws, straight.
03-5610 350mm
03-5611 500mm

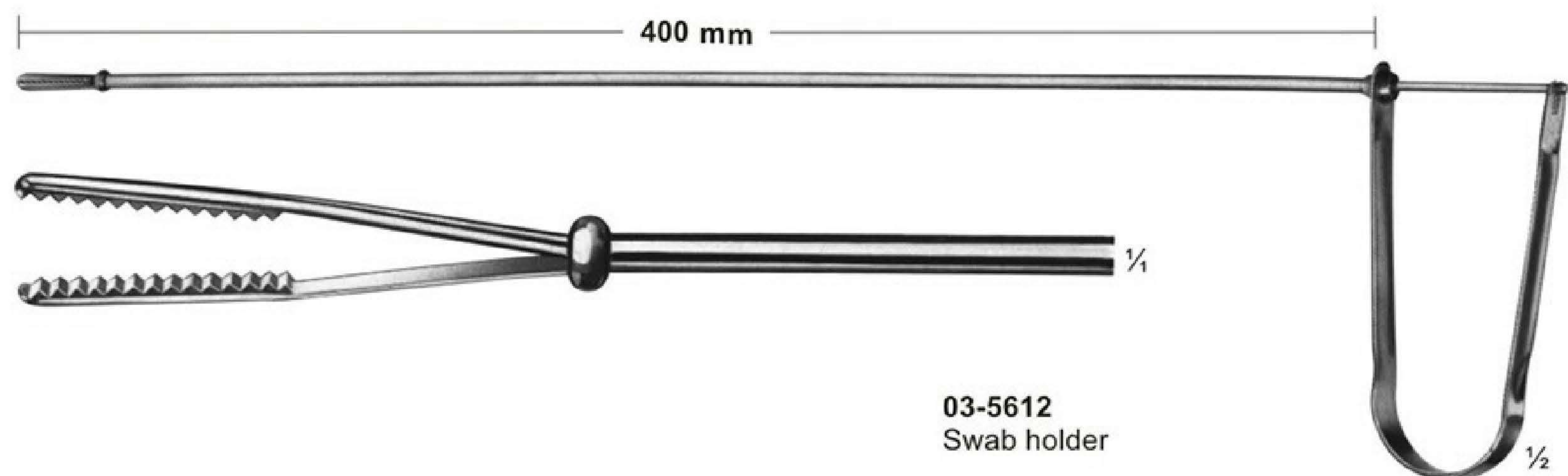
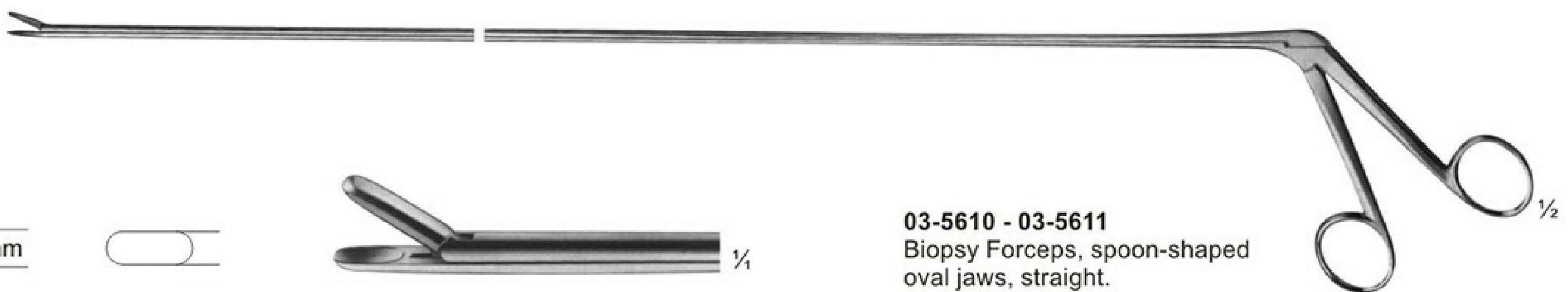

Haemorrhoidal Forceps

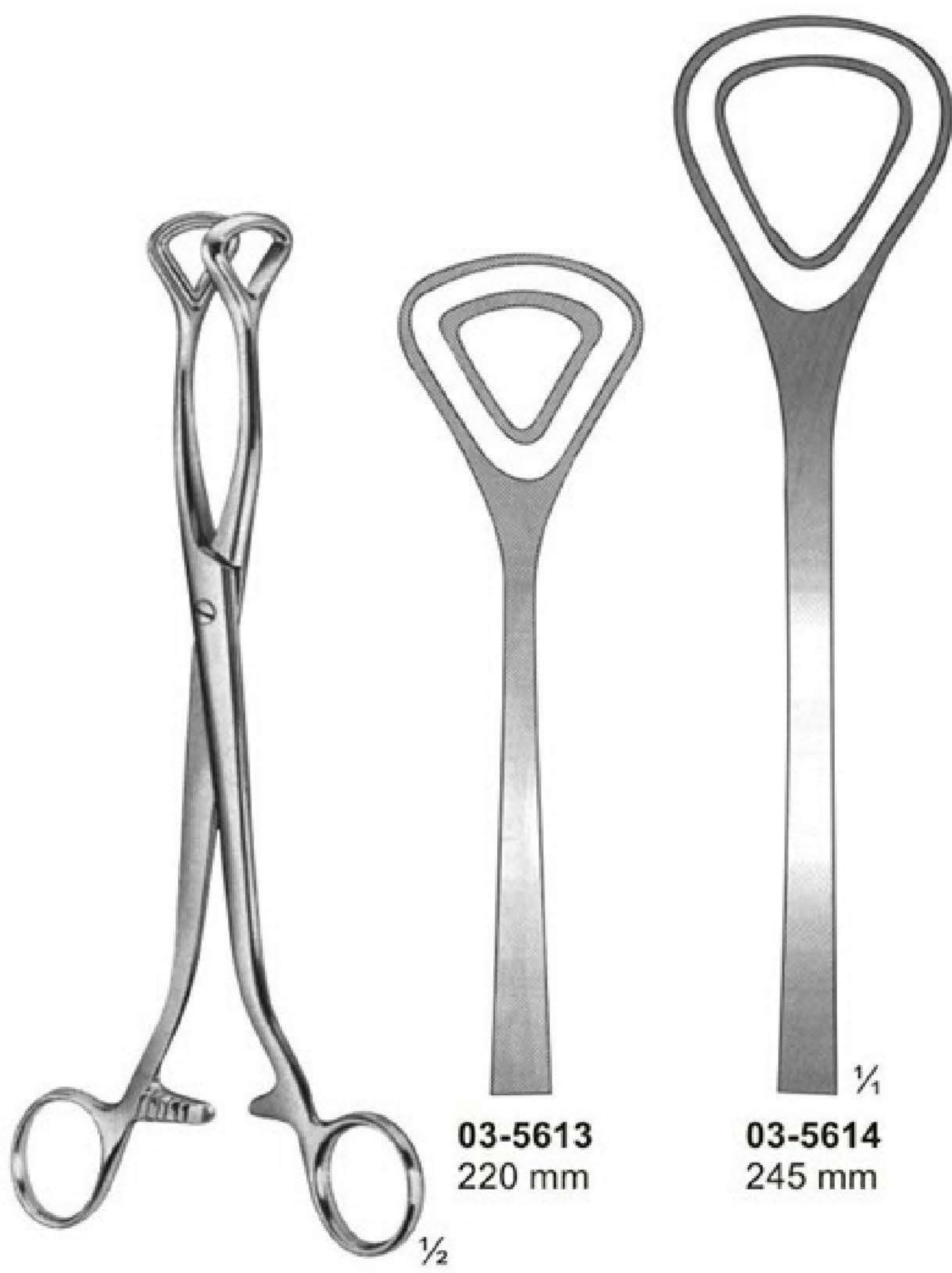

03-5613 - 03-5614
 LUER

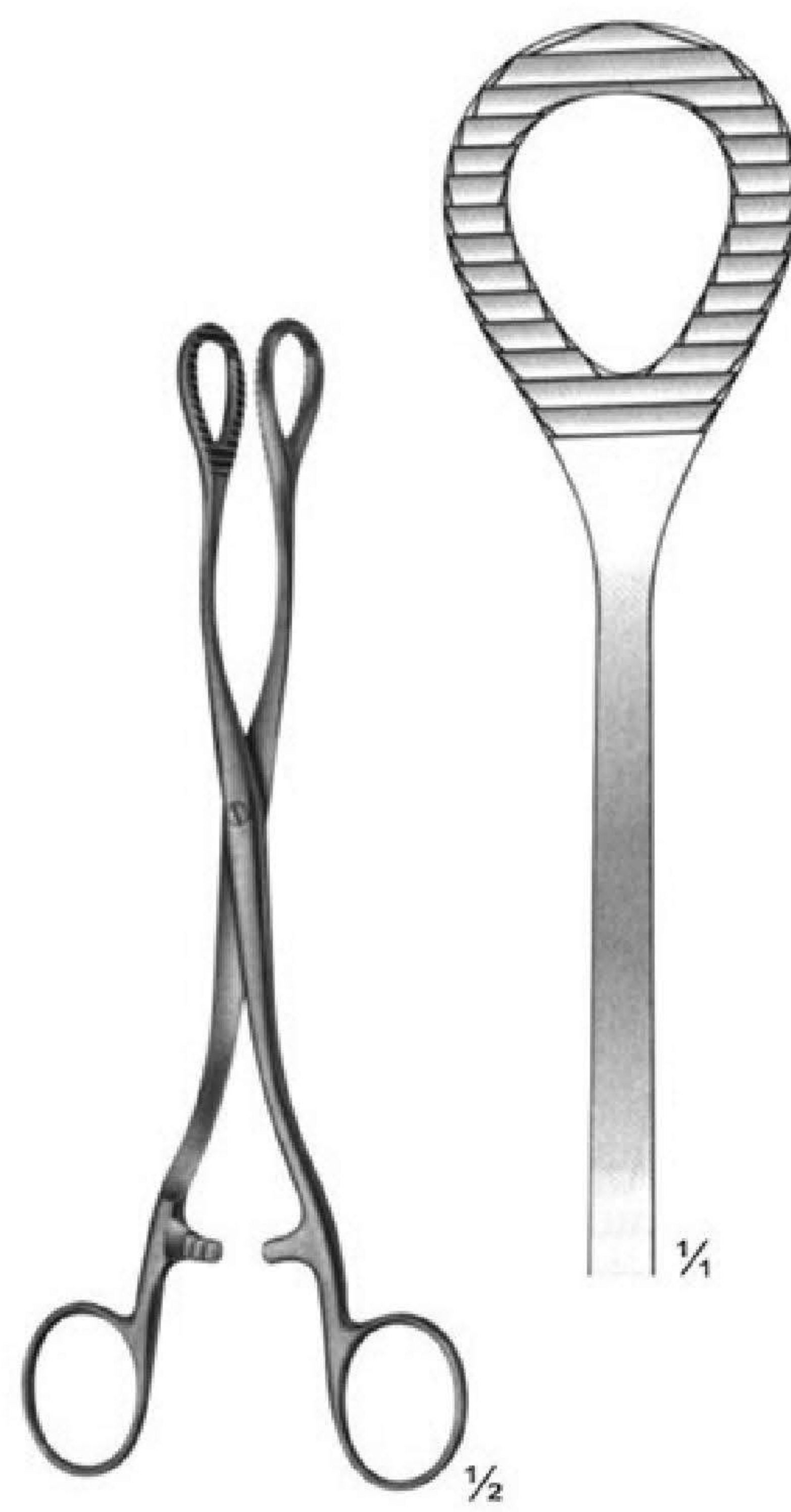

03-5615
 HEYWOOD-SMITH
 200 mm



03-5616
 HEYWOOD-SMITH
 modif
 215 mm

Haemorrhoidal Forceps

Atraumata

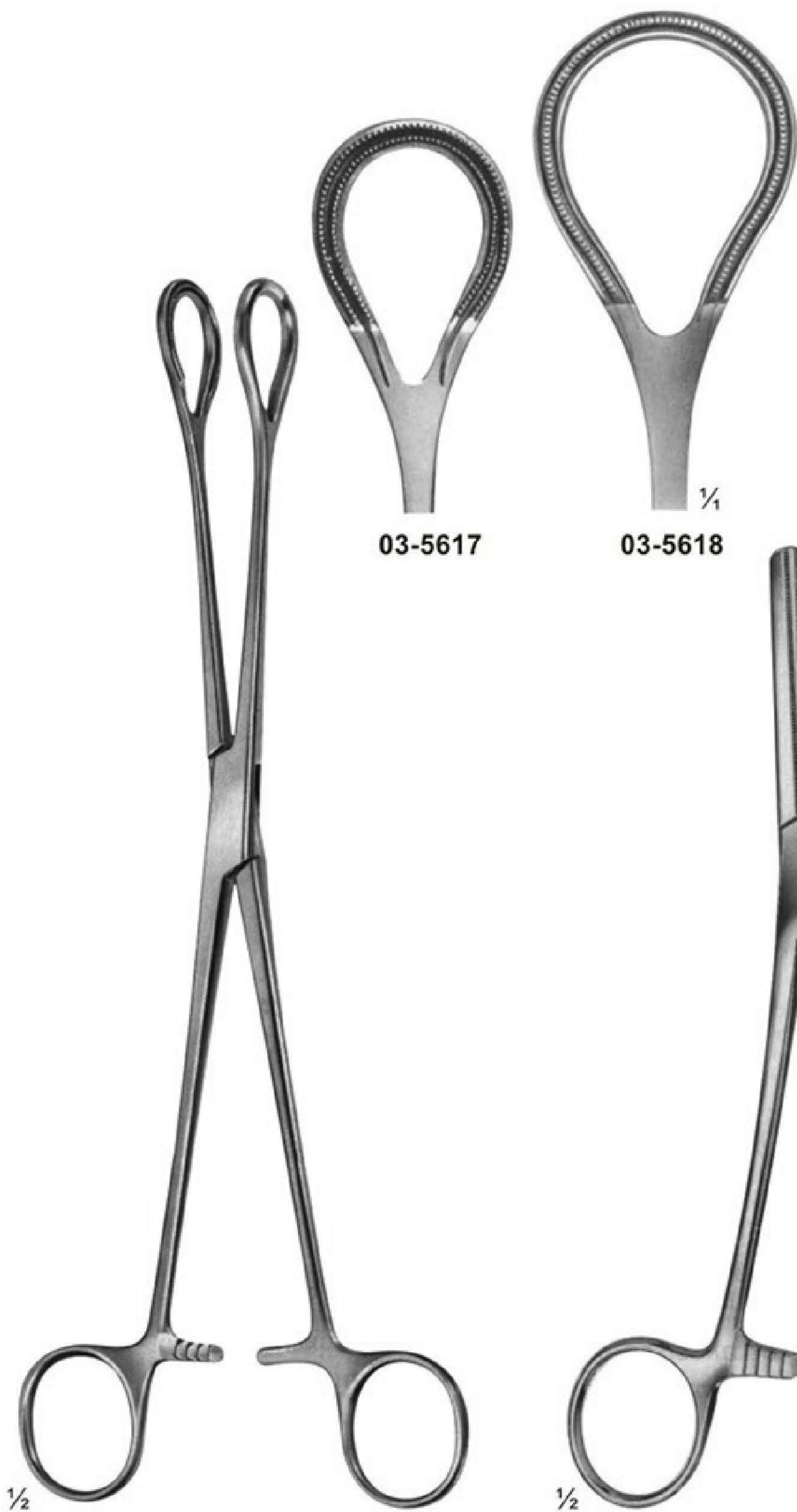

03-5617
 250 mm
 03-5618
 270 mm

Pressure Clamp

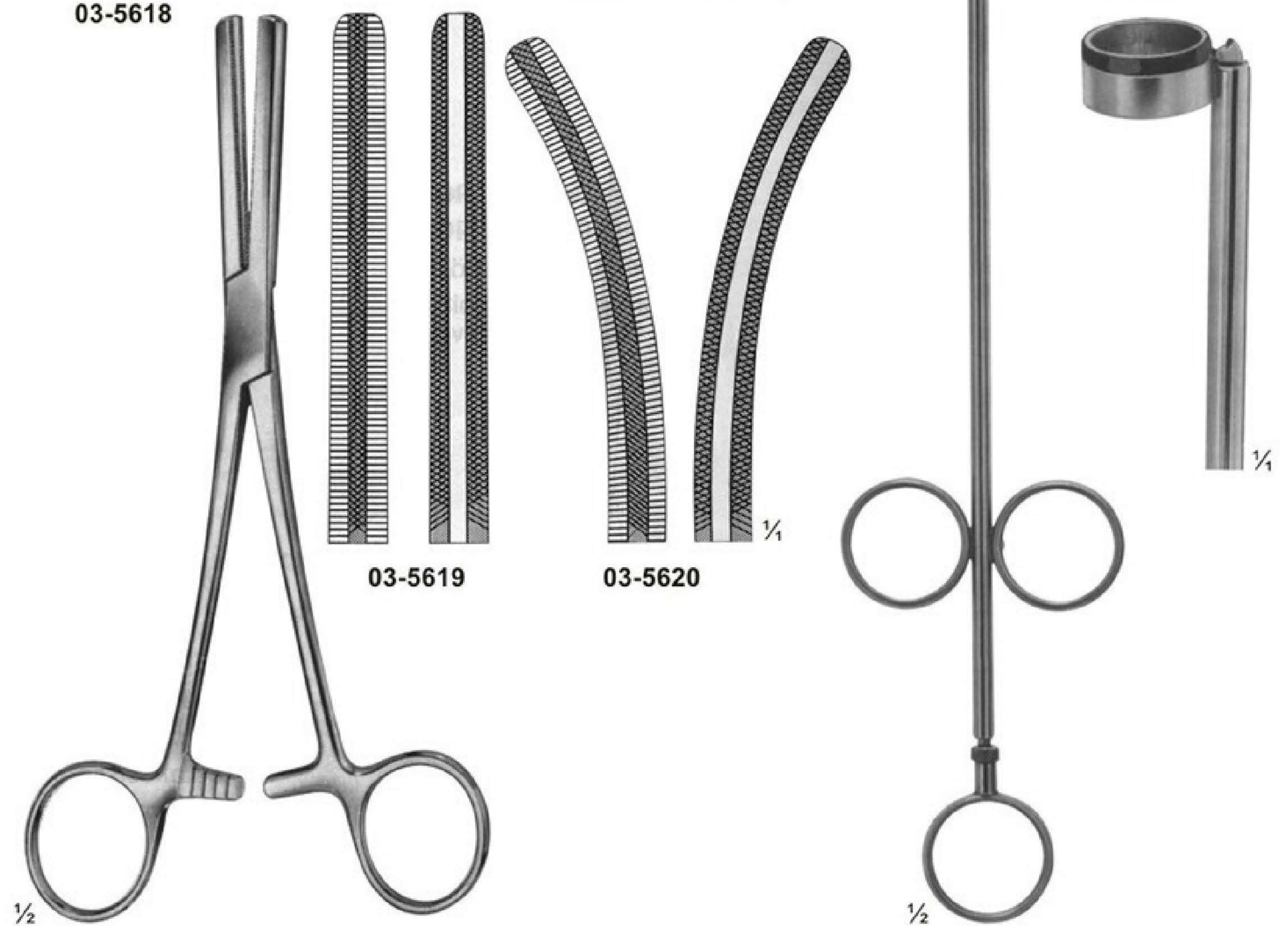

03-5619 - 03-5620
 FERGUSON
 200 mm

03-5621
 RUDD
 Haemorrhoidal ligator
 with loading
 attachment and 100
 ligature rubber rings
 315 mm