

Gall Duct Forceps



03-5622
 LOWER
 180 mm



03-5623
 LAHEY (SWEET)
 190 mm



03-5624
 LAHEY
 220 mm



03-5625
 DESJARDINS
 Gall duct-and cystic forceps
 210 mm



03-5626
 NISSEN
 Gall duct-and cystic forceps
 215 mm

Gall Duct Forceps and Choledochus Forceps

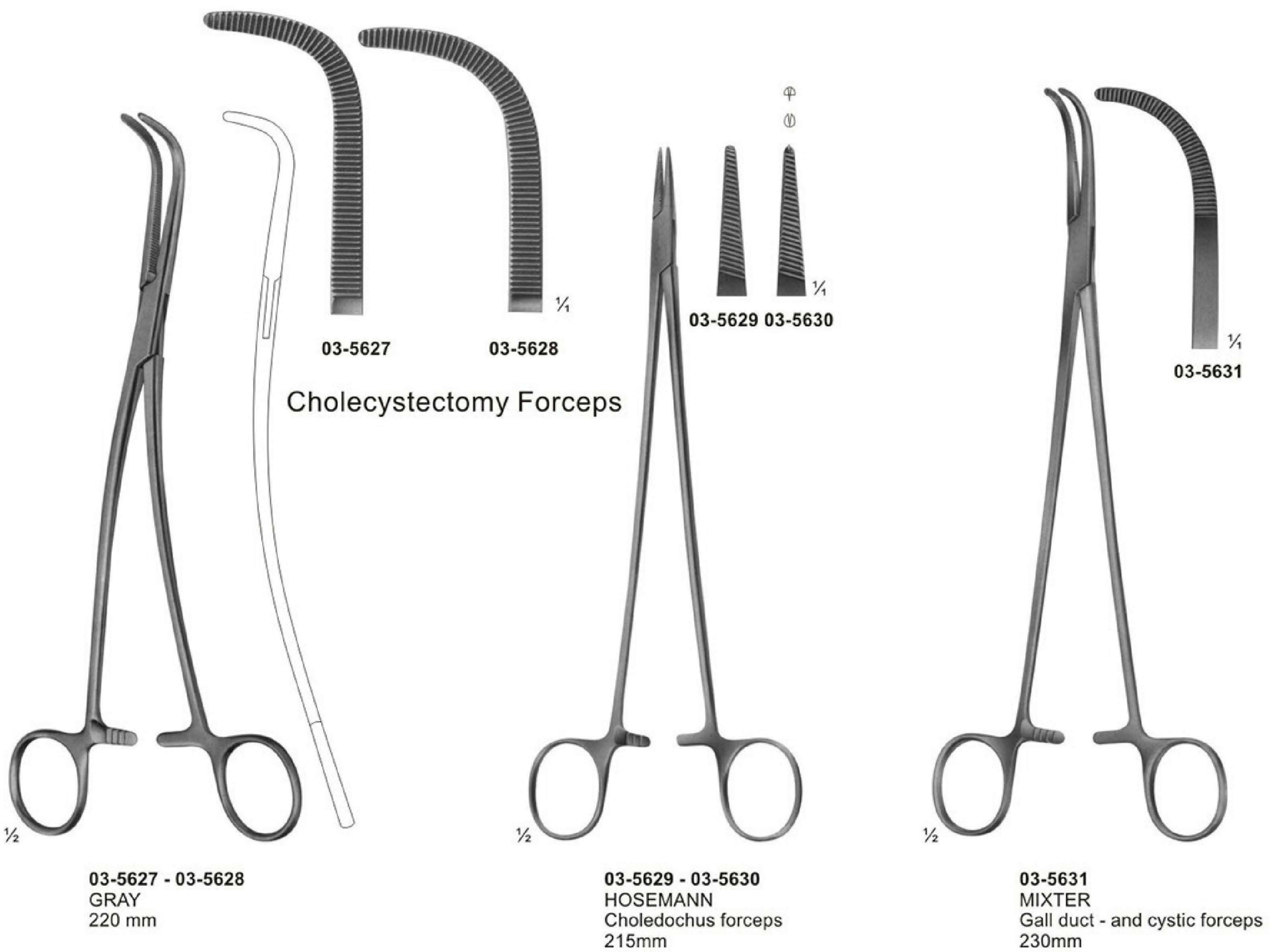

Gall Bladder Forceps and Gall Duct Scissors

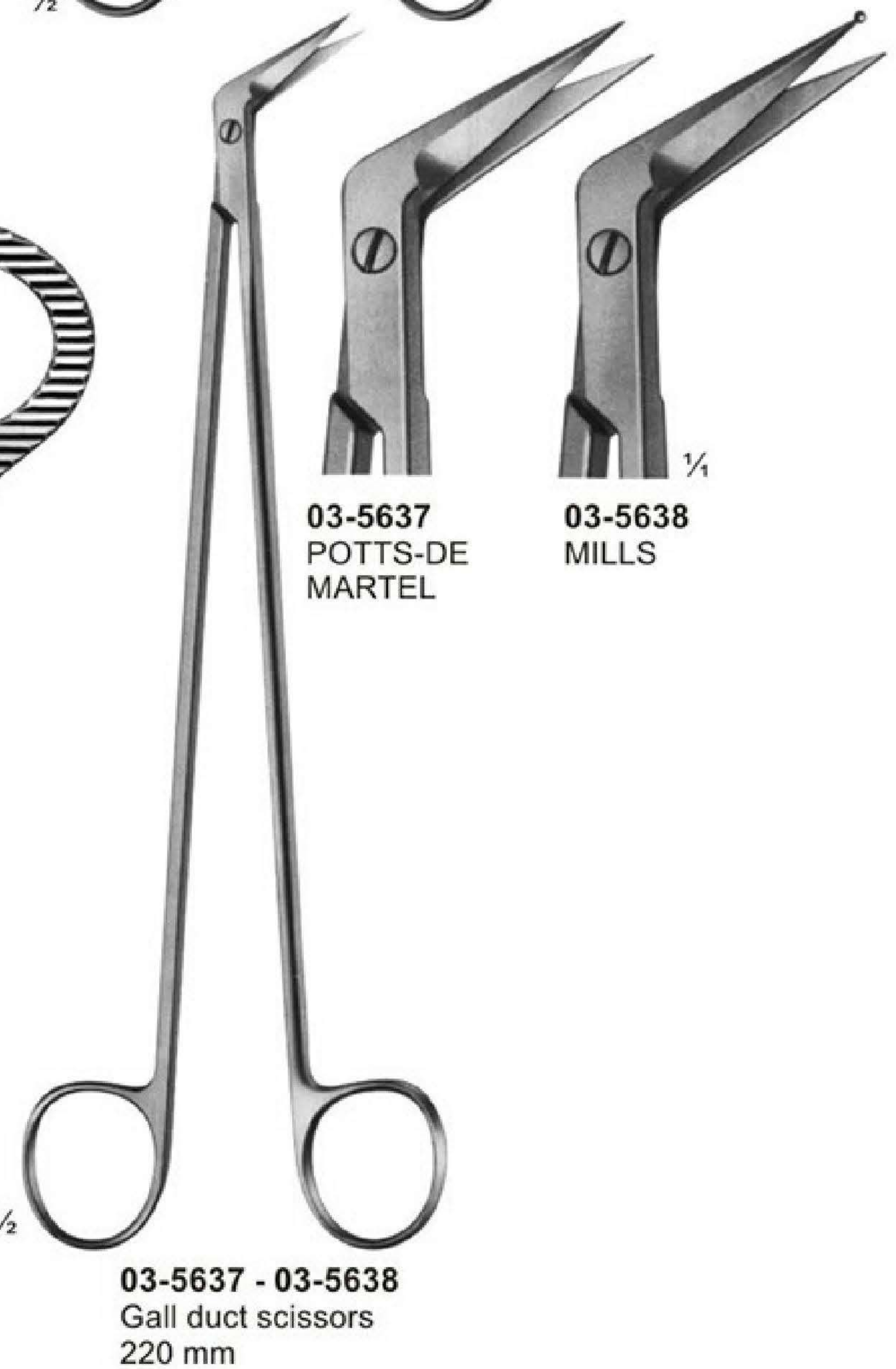
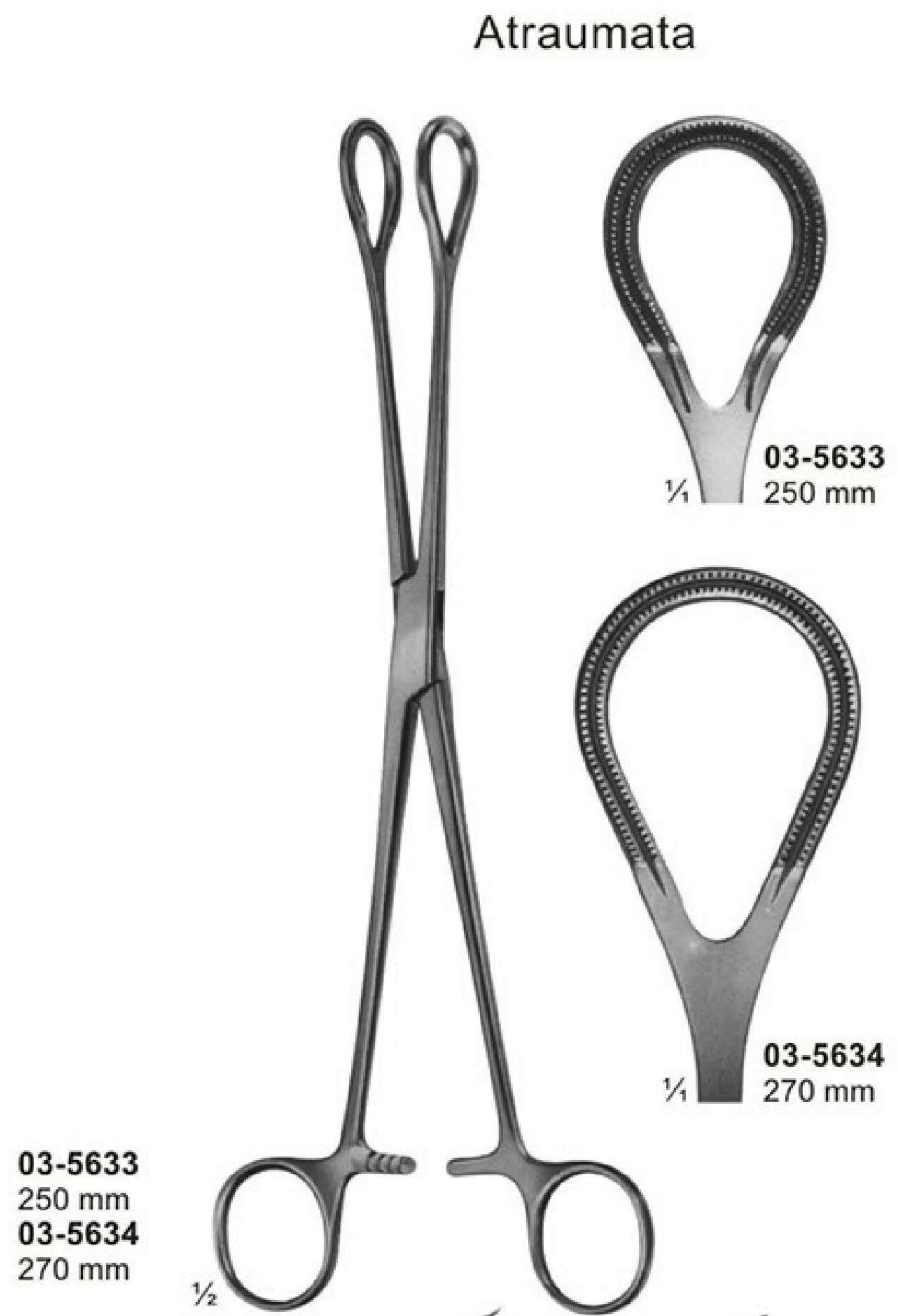
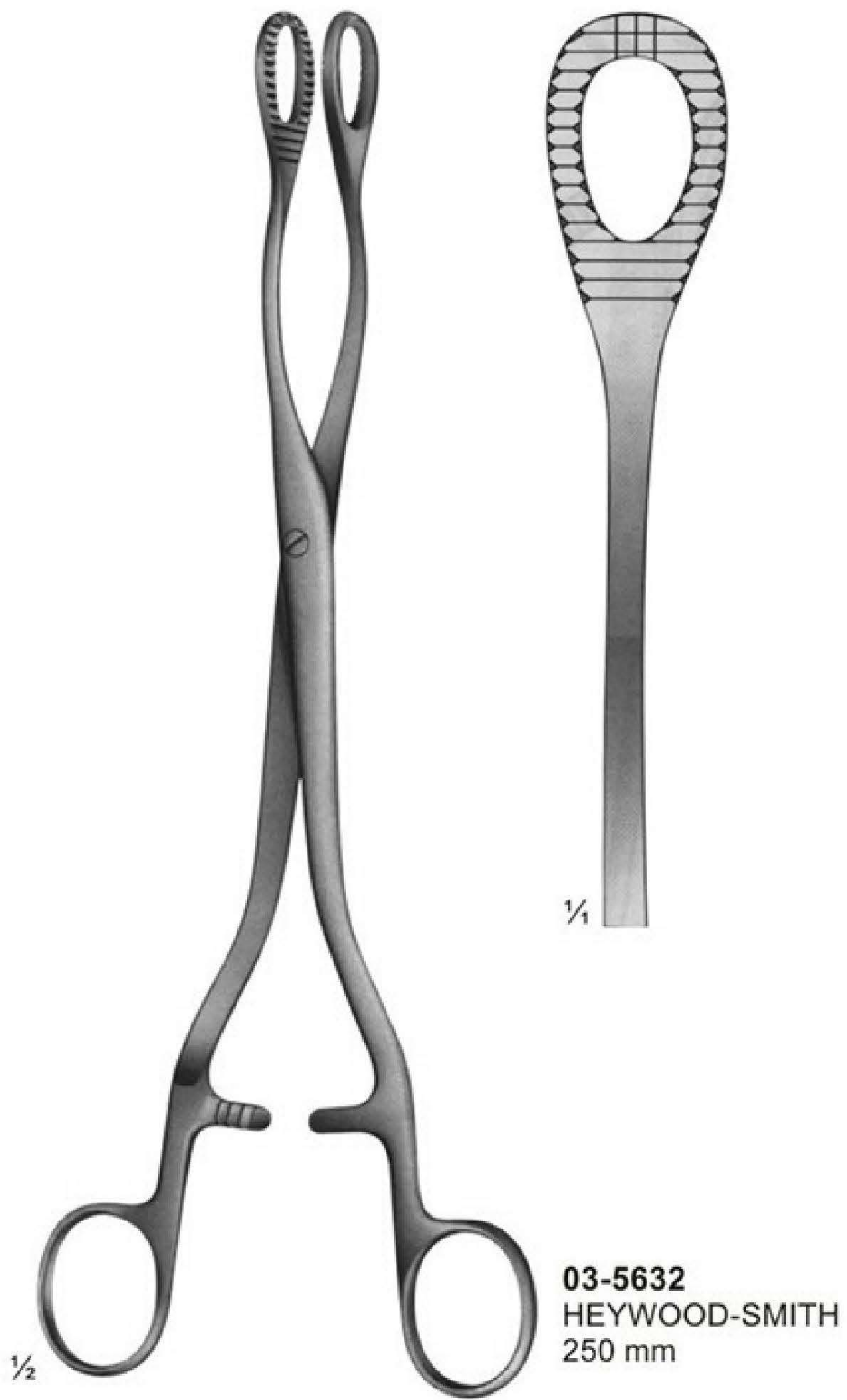

Gall Duct Probes

∅ 3.5 mm



1/2
03-5639
HAJEK
Irrigating cannula,
silver
165 mm

∅ 5 mm



1/2
03-5640
MOYNIHAN
Gall stone probe
and scoop of tin,
malleable.
365 mm

∅ 5 mm



1/2
03-5641
MAYO
Gall duct probes,
malleable
330 mm

∅ 3.5 mm

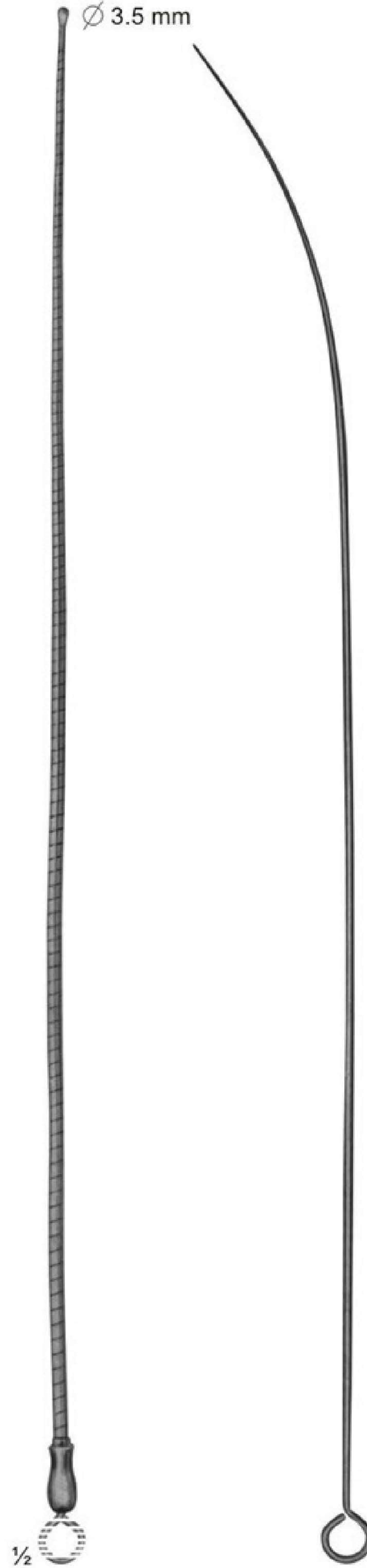

1/2
03-5642
OCHSNER
Gall duct probes, flexible
400 mm

∅ 3.8 mm

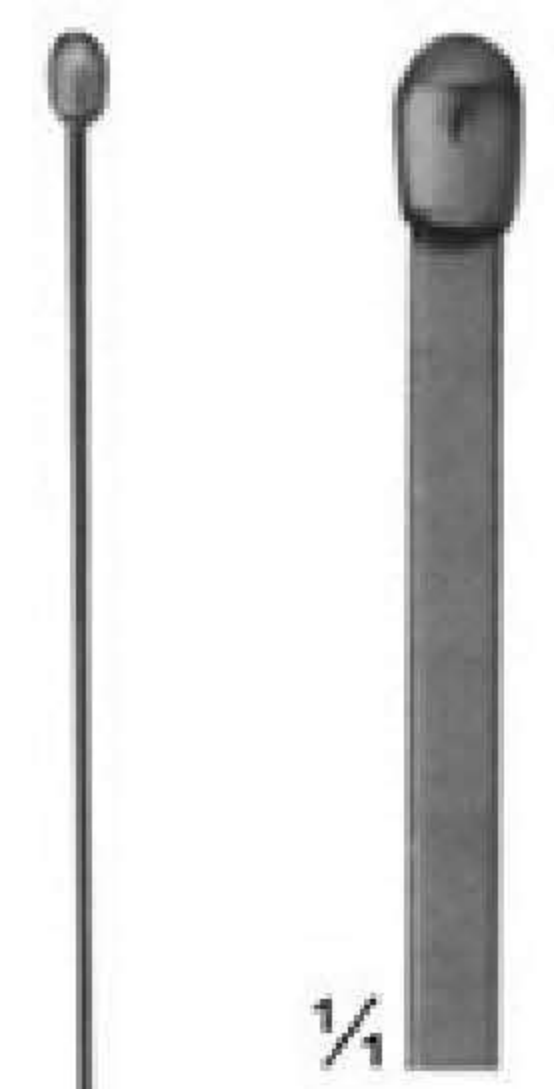

1/4
03-5643

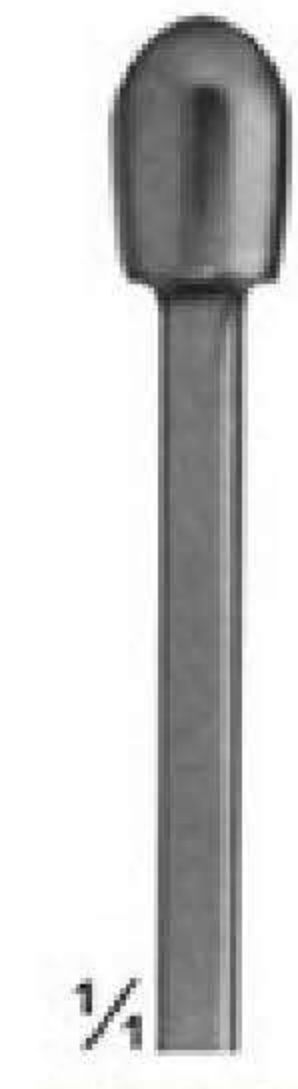

1/4
03-5644
∅ 4.3mm



1/4
03-5645
∅ 6.8mm

1/2
03-5643 - 03-5645
DESJARDINS
Gall duct probes,
flexible
285 mm

Gall Duct Dilators & Gall Stone Scoops

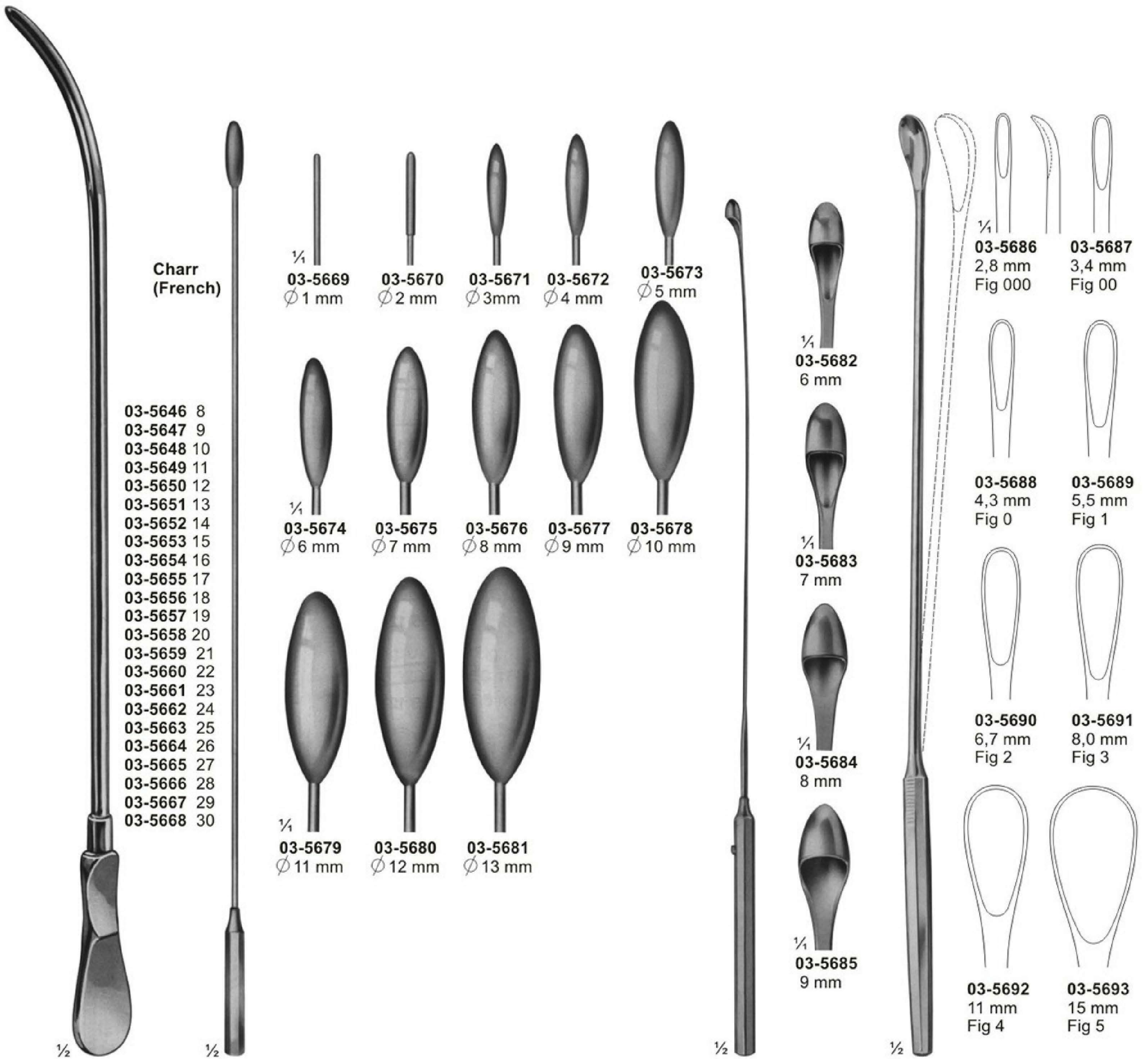

**Charr
(French)**

- 03-5646 8
- 03-5647 9
- 03-5648 10
- 03-5649 11
- 03-5650 12
- 03-5651 13
- 03-5652 14
- 03-5653 15
- 03-5654 16
- 03-5655 17
- 03-5656 18
- 03-5657 19
- 03-5658 20
- 03-5659 21
- 03-5660 22
- 03-5661 23
- 03-5662 24
- 03-5663 25
- 03-5664 26
- 03-5665 27
- 03-5666 28
- 03-5667 29
- 03-5668 30

- 1/4
03-5669
Ø 1 mm
- 03-5670
Ø 2 mm
- 03-5671
Ø 3mm
- 03-5672
Ø 4 mm
- 03-5673
Ø 5 mm
- 1/4
03-5674
Ø 6 mm
- 03-5675
Ø 7 mm
- 03-5676
Ø 8 mm
- 03-5677
Ø 9 mm
- 03-5678
Ø 10 mm
- 1/4
03-5679
Ø 11 mm
- 03-5680
Ø 12 mm
- 03-5681
Ø 13 mm

- 1/4
03-5682
6 mm
- 1/4
03-5683
7 mm
- 1/4
03-5684
8 mm
- 1/4
03-5685
9 mm

- 1/4
03-5686
2,8 mm
Fig 000
- 03-5687
3,4 mm
Fig 00
- 03-5688
4,3 mm
Fig 0
- 03-5689
5,5 mm
Fig 1
- 03-5690
6,7 mm
Fig 2
- 03-5691
8,0 mm
Fig 3
- 03-5692
11 mm
Fig 4
- 03-5693
15 mm
Fig 5

03-5646 - 03-5668
DITTEL
Metal bougies and
dilating sounds, stiff
345 mm

03-5669 - 03-5681
BAKES
Common bile duct
dilators, malleable
03-5669-03-5673 315mm
03-5674-03-5681 320mm
Set of 9 pieces (03-5671-03-5679)
in canvas roll

03-5682 - 03-5685
DESJARDINS
Probes and catch
with flexible shaft
300 mm

03-5686 - 03-5693
LUER-KOERTE
modif with malleable shaft
310 mm

Gall Stone Forceps

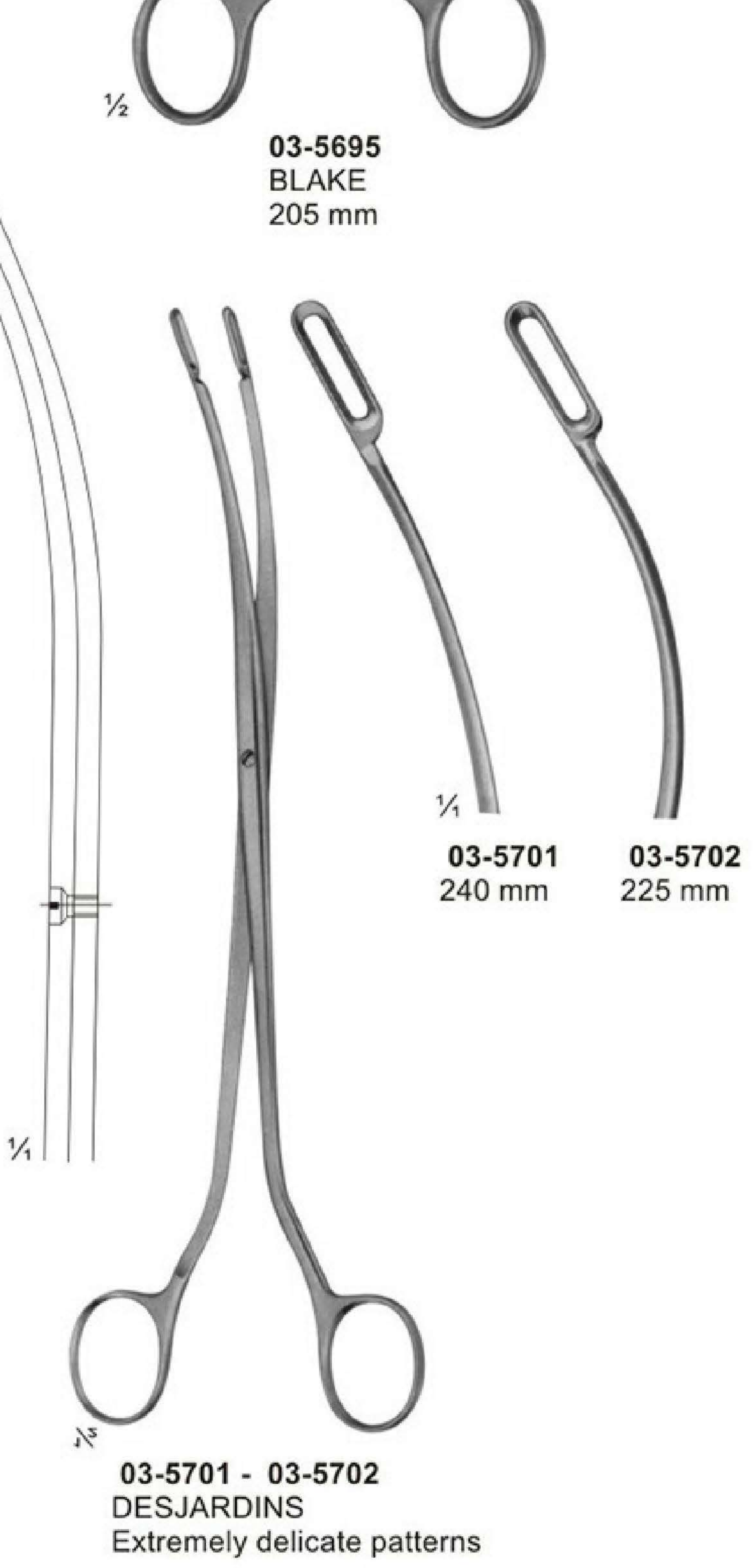
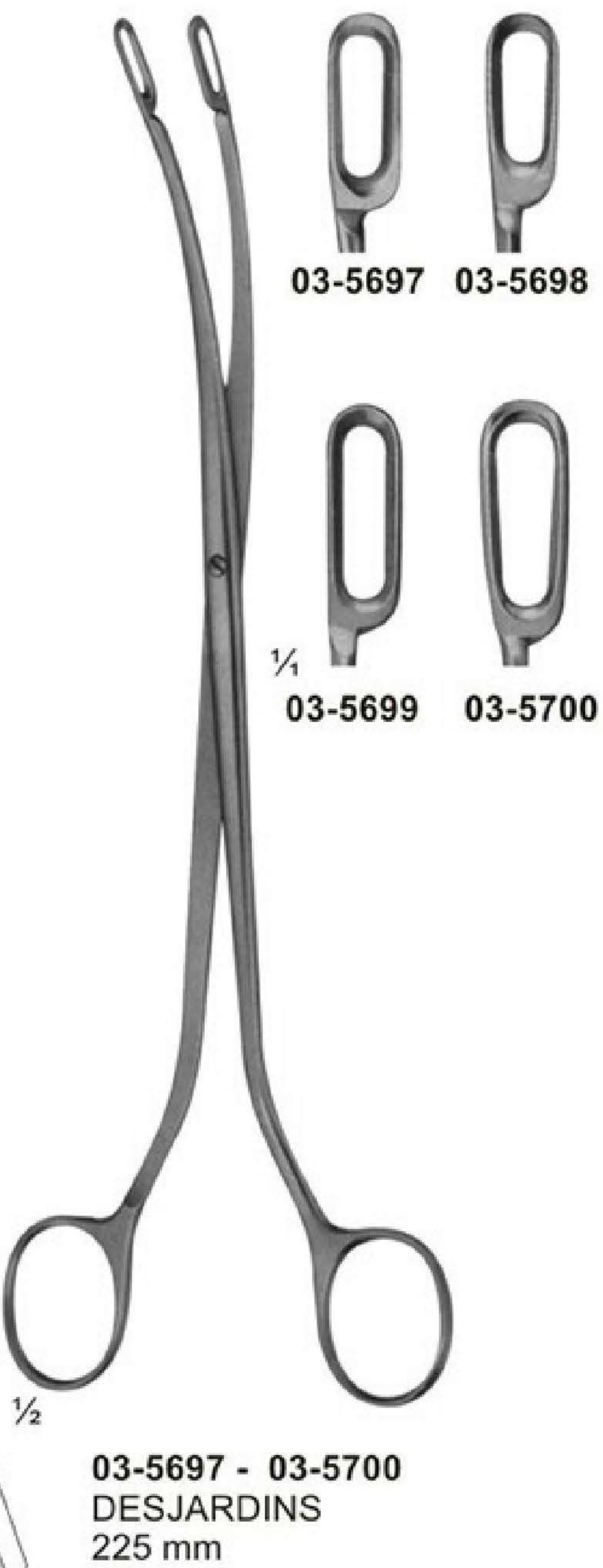
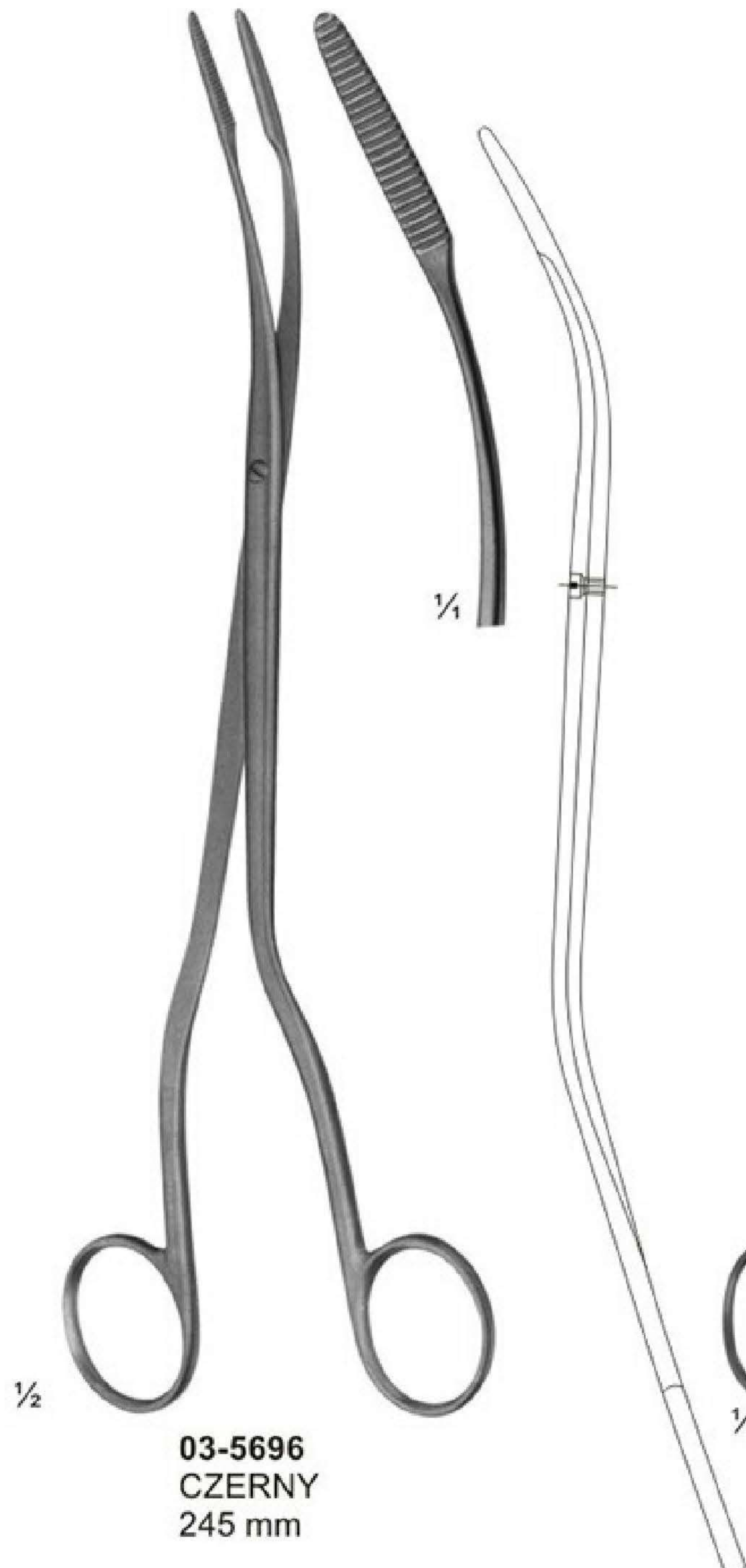
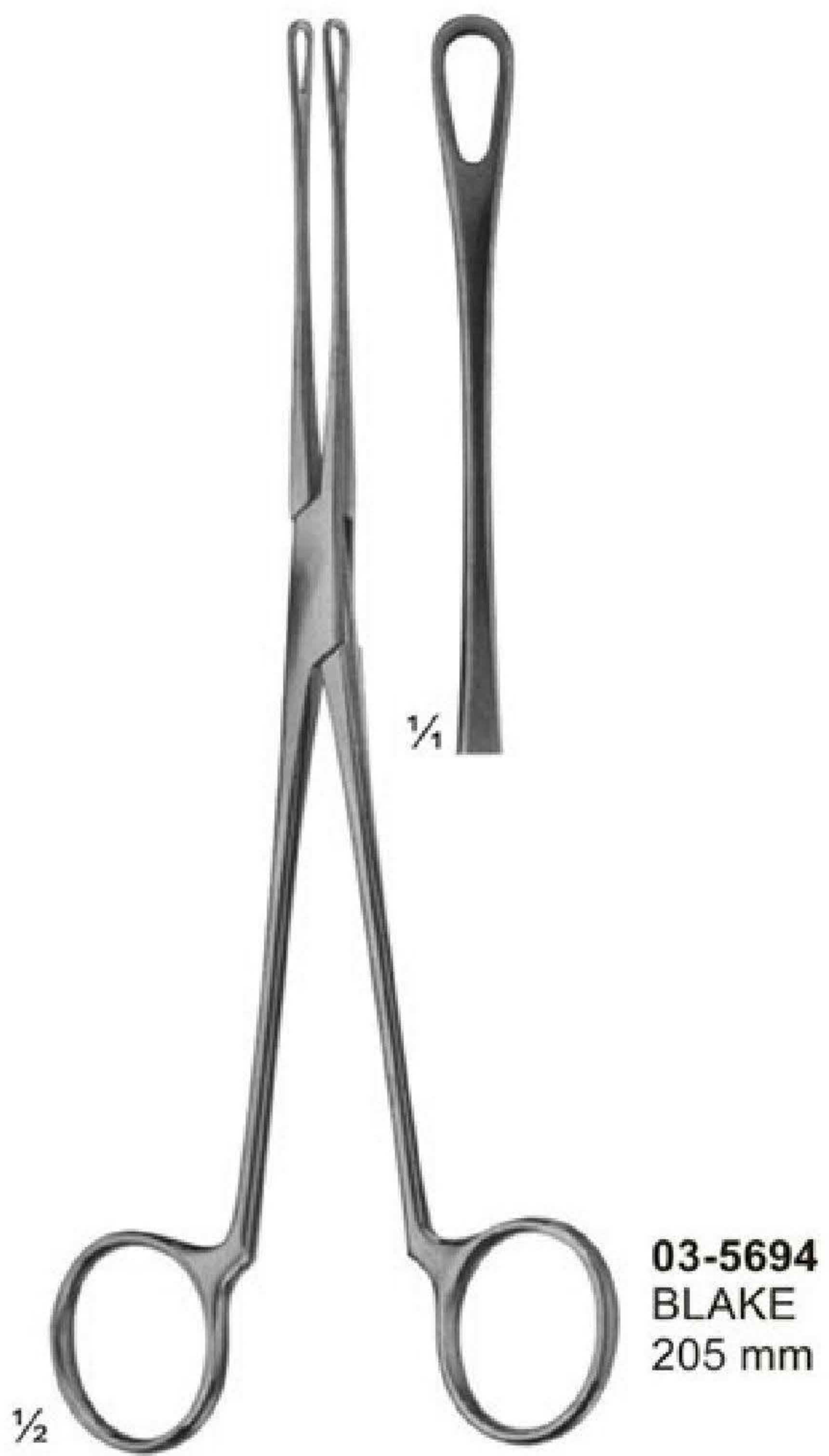

Kidney Clamps

Atraumata

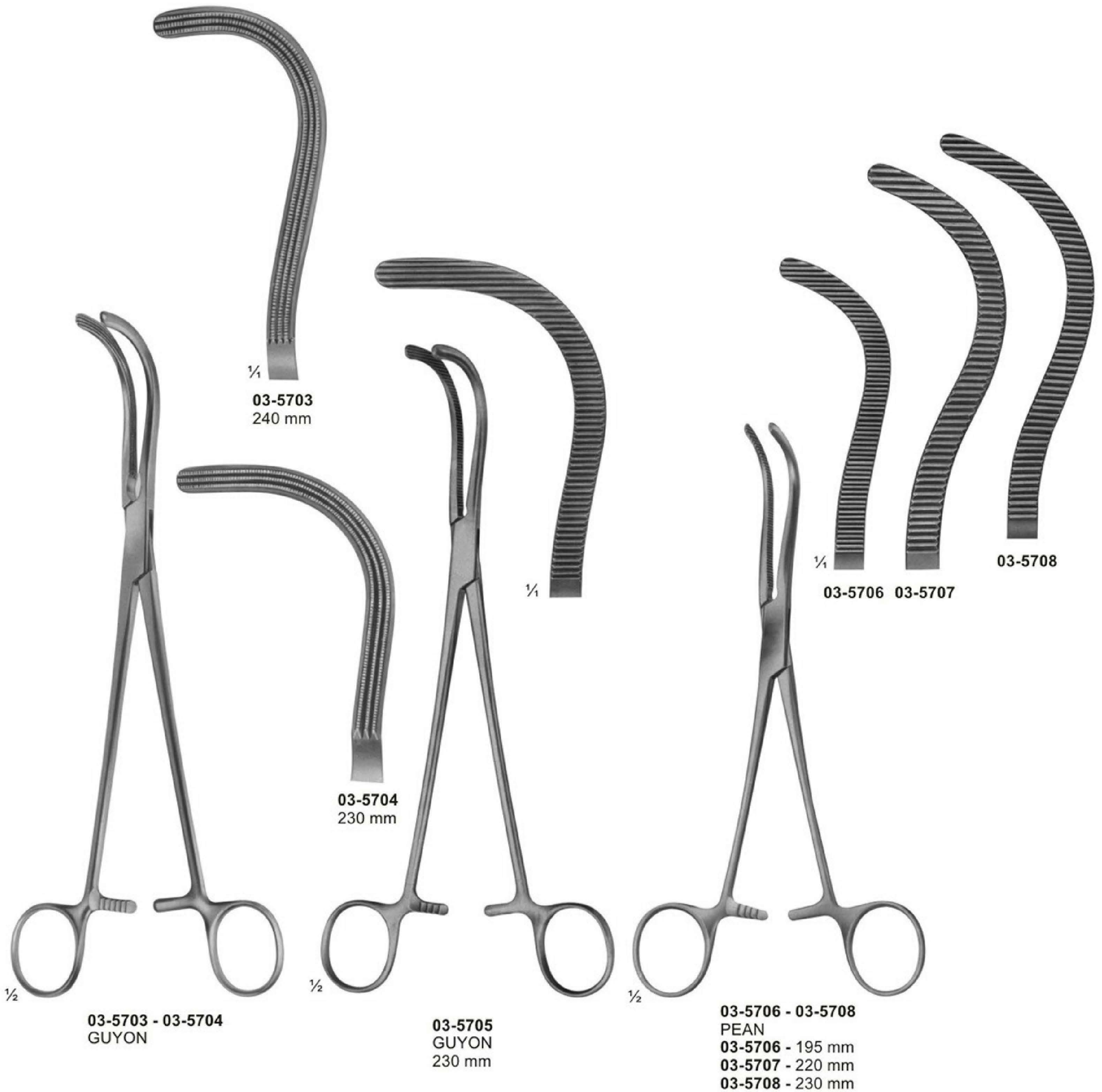

Kidney and Pedicle Clamps

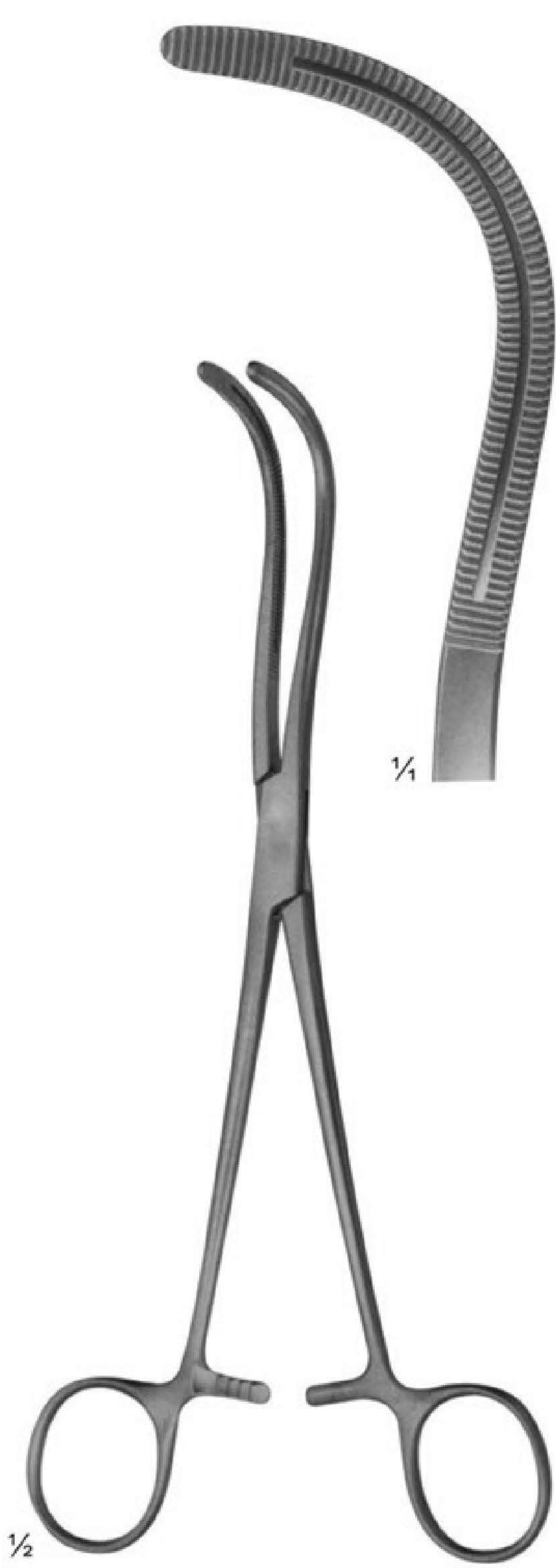

03-5709
STILLE
220 mm

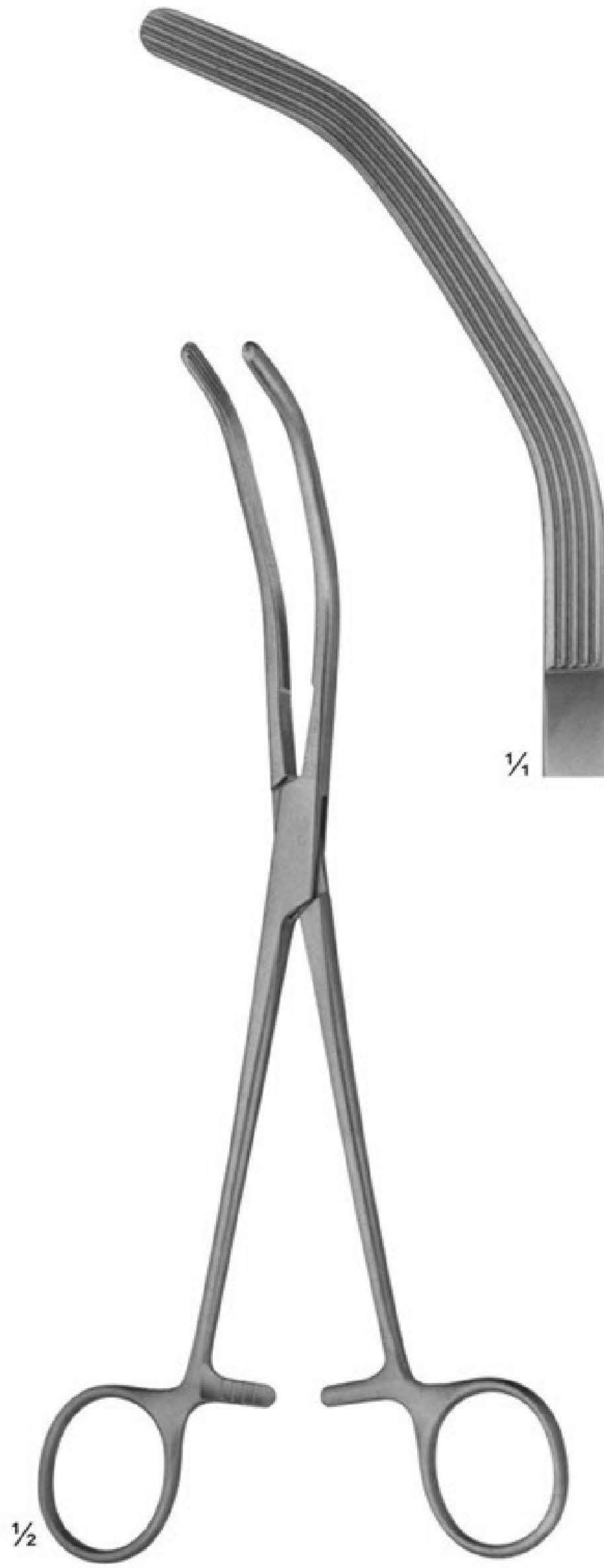

03-5710
HERRICK
225 mm

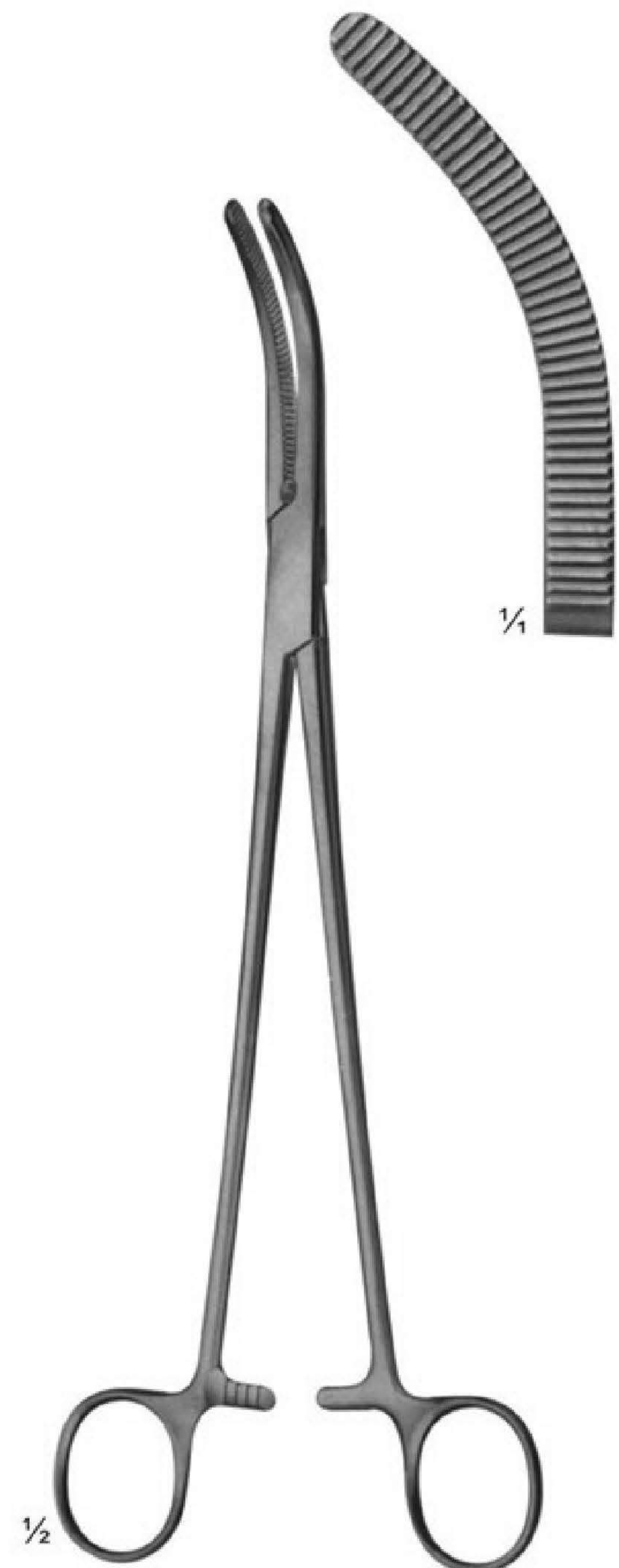

03-5711
WERTHEIM
225 mm

Kidney Elevating Forceps



03-5712
COLLIN
285 mm



03-5713
DARTIGUES
255 mm

Kidney Stone Forceps



03-5714



03-5715



03-5716



$\frac{1}{4}$
 03-5717



03-5718



$\frac{1}{4}$
 03-5719



$\frac{1}{2}$

03-5714 - 03-5717
 RANDALL
 225 mm



$\frac{1}{2}$

03-5718 - 03-5719
 RANDALL
 190 mm

Bladder Retractors

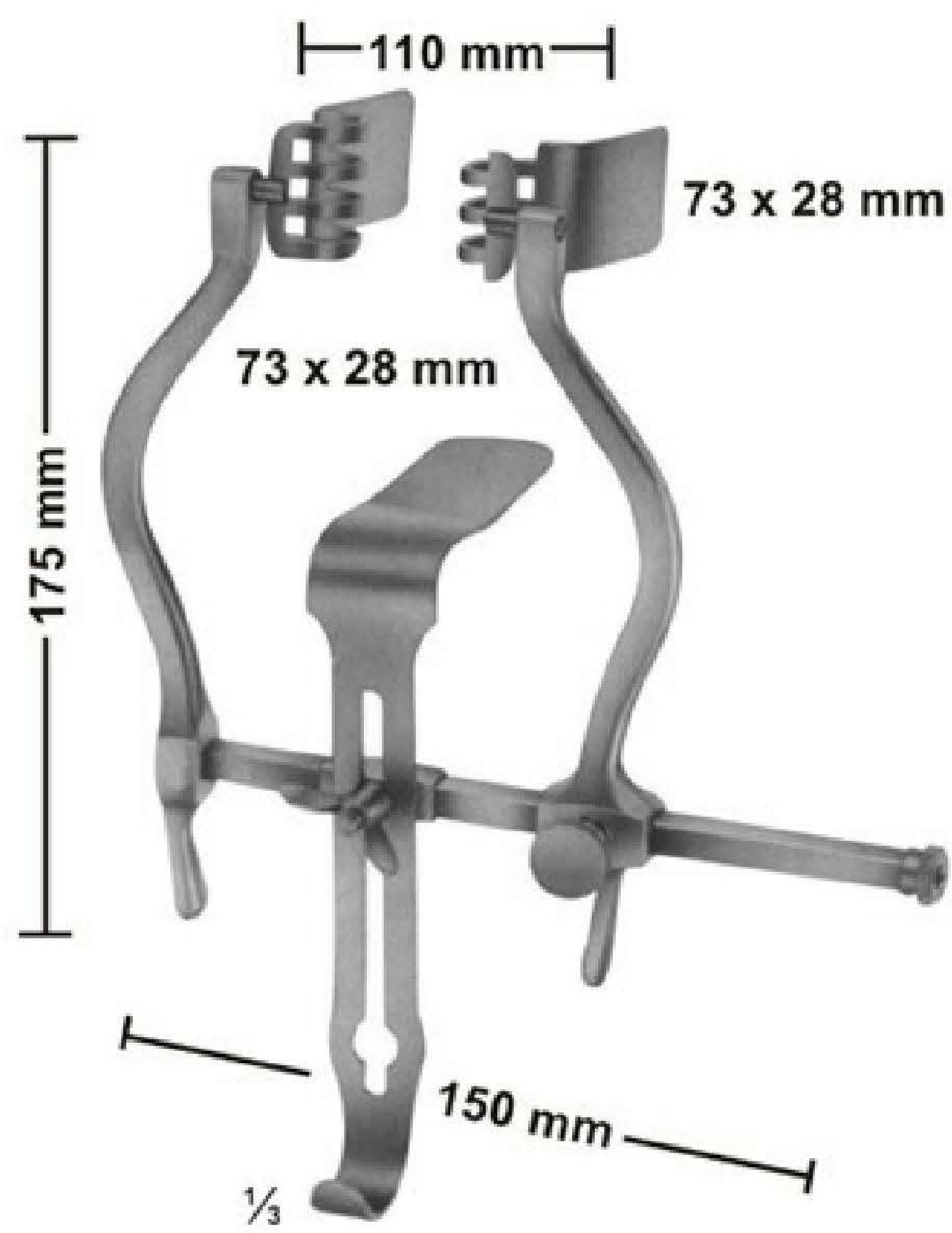

03-5720
JUDD-MASSON
 Bladder-and suprapubic
 retractor

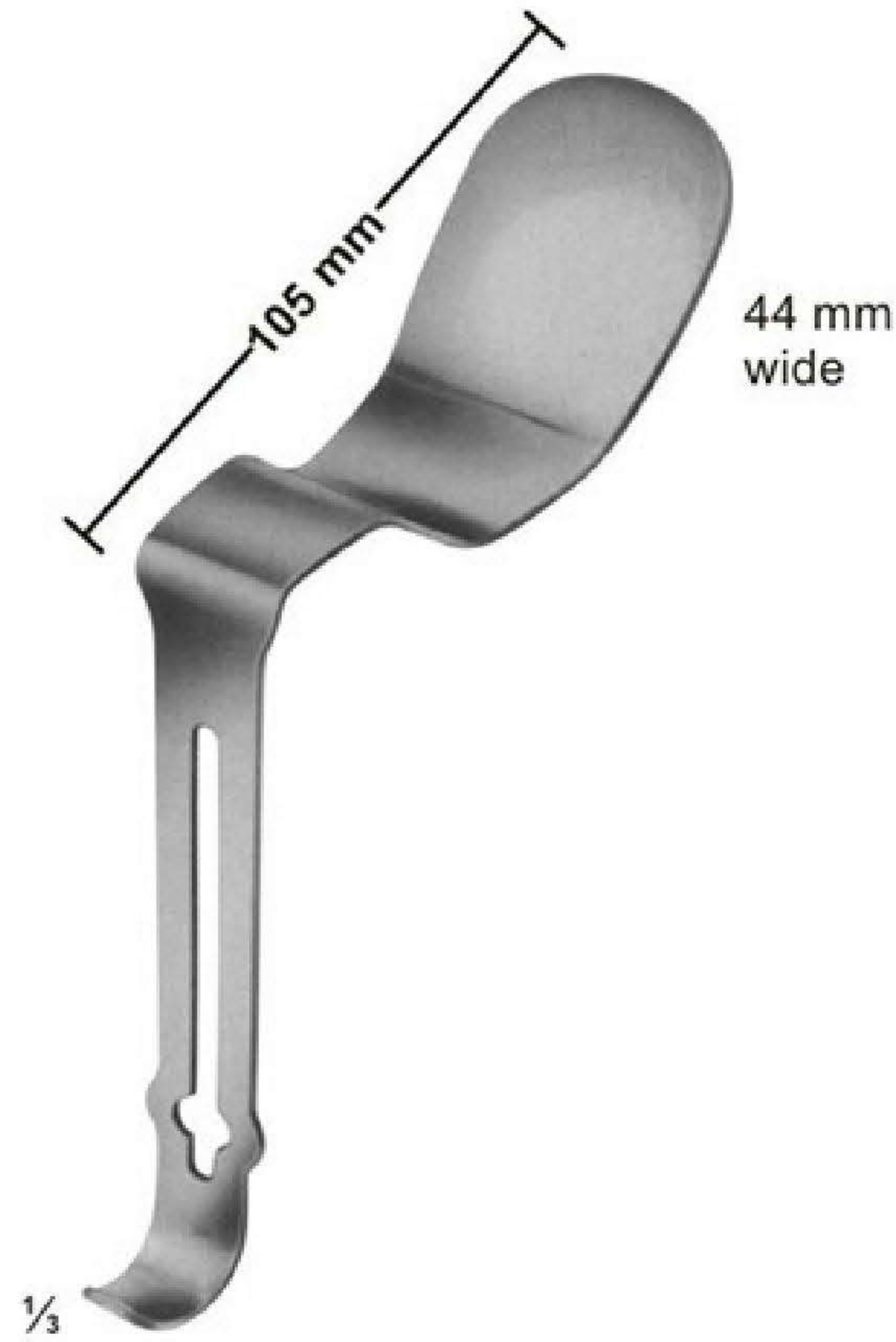

03-5721
MILLIN
 Center blade for (05-6993)
 retro pubic prostatectomy



03-5722
MILLIN
 Bladder retractor
03-5722 Spreader only
03-5723 Blades 57x25mm
03-5724 Blades 82x25mm
03-5725 Center blade 105x45mm



03-5726
LEGUEU
 Bladder retractor
 Center blade
 80 x 31 mm



03-5727
LEGUEU
 Bladder spatula
 260 mm

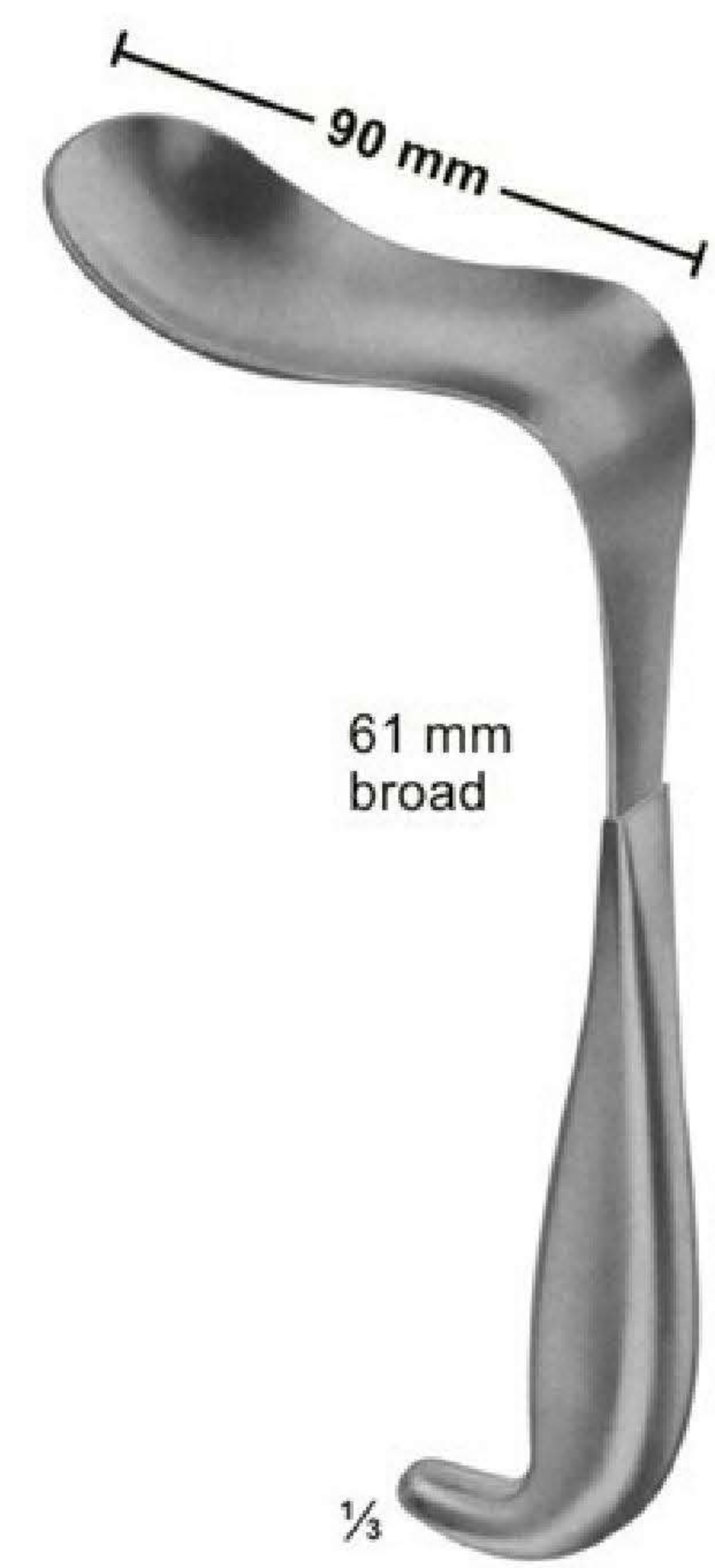

03-5728
KOCHER
 Bladder spatula
 235 mm

Genito-Urinary Instruments



03-5729
MATHIEU
Foreign body forceps
Length of shaft
190 mm



03-5730
MILLIN
Lobe grasping
forceps
235 mm

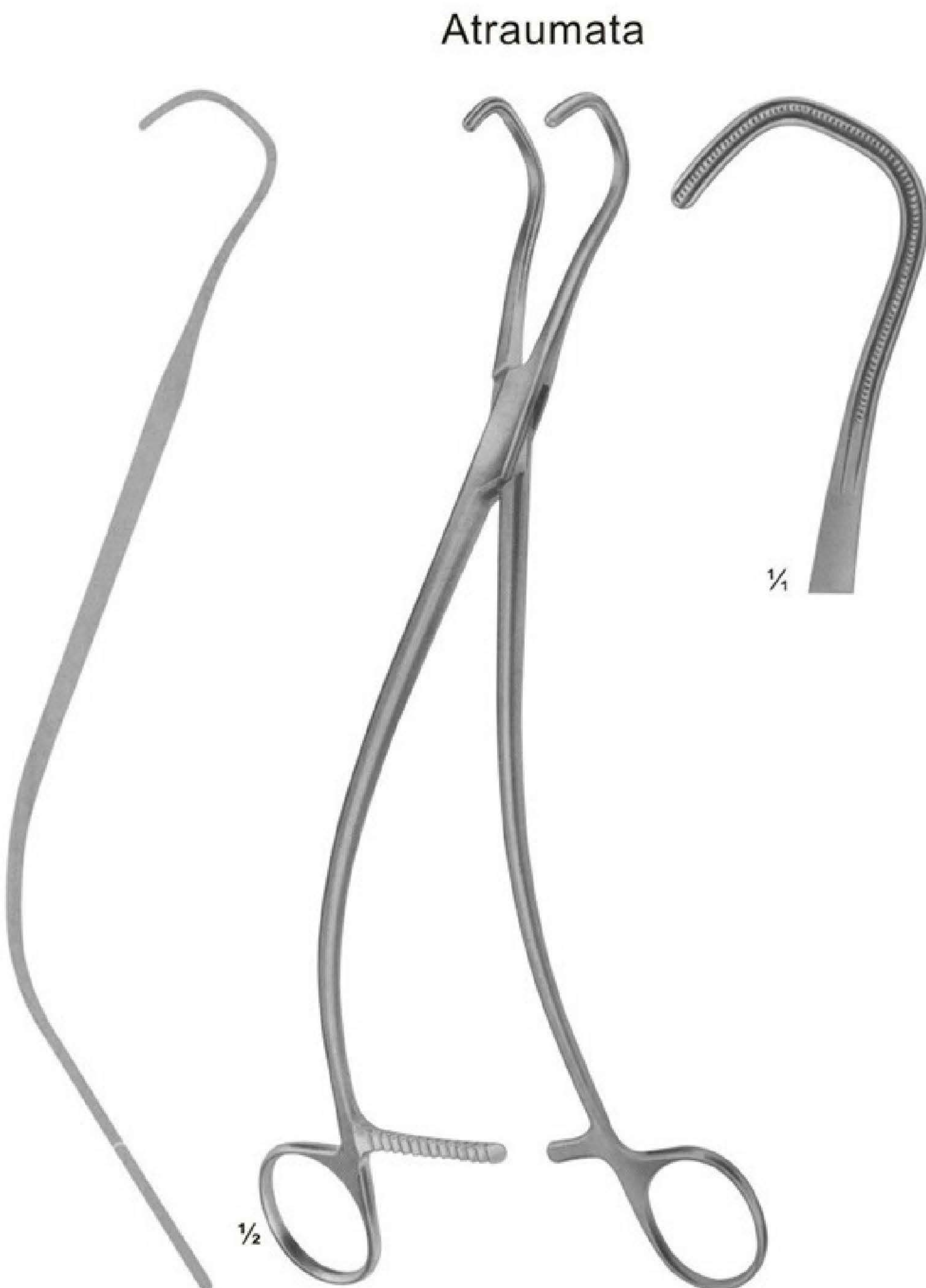

03-5731
Ureter forceps
240 mm

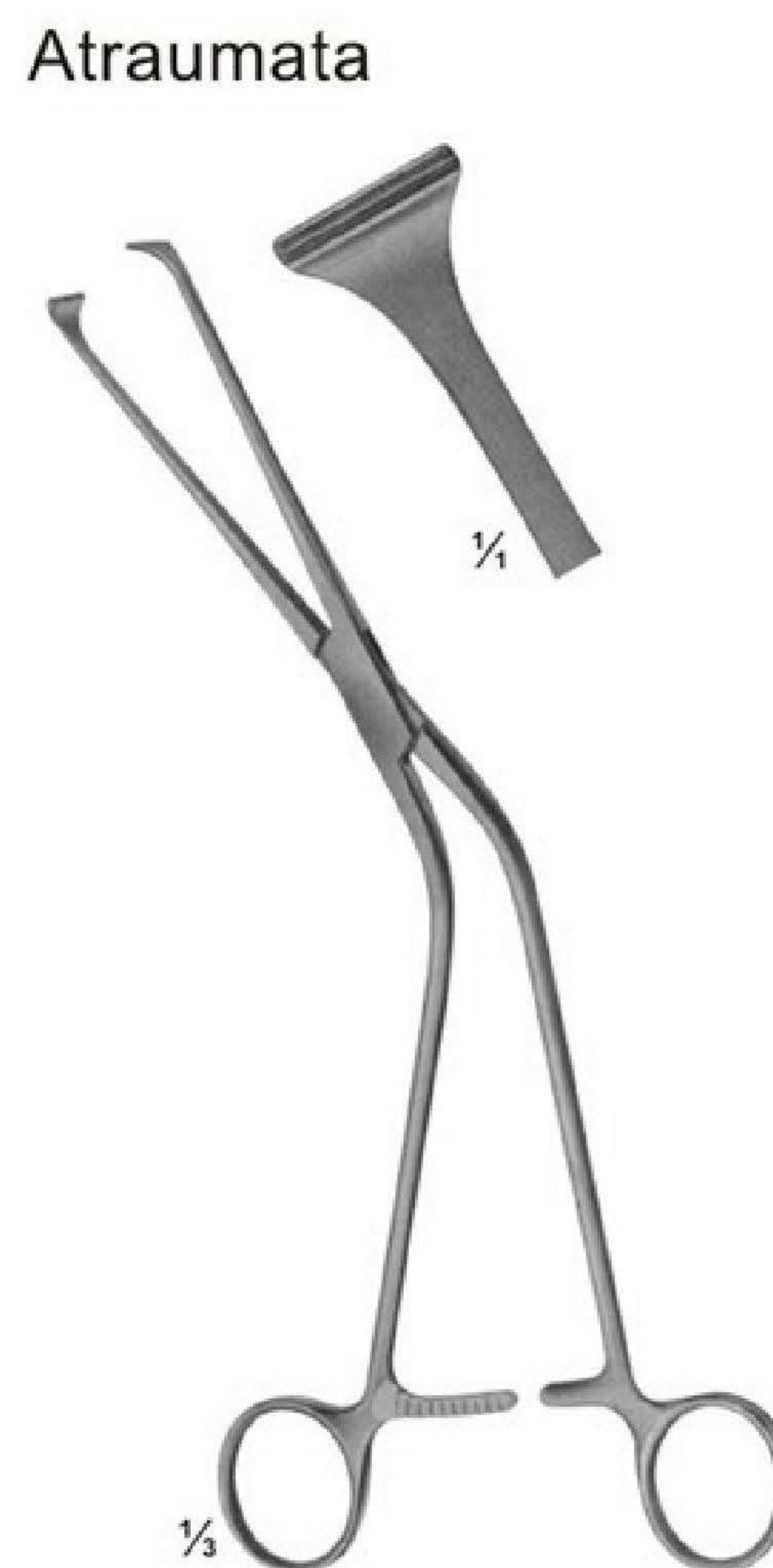

03-5732
MILLIN
Lobe grasping
forceps
245 mm



03-5733
MILLIN
Bladder neck spreader
285 mm

Genito-Urinary Instruments



03-5734
GUYON
Catheter guide
(introducer)
365 mm

Charr.
(French)

- 03-5735 6
- 03-5736 7
- 03-5737 8
- 03-5738 9
- 03-5739 10
- 03-5740 11
- 03-5741 12
- 03-5742 13
- 03-5743 14
- 03-5744 15
- 03-5745 16
- 03-5746 18
- 03-5747 20



03-5735 - 03-5747
Female catheters,
metal
160 mm

Charr.
(French)

- 03-5748 8
- 03-5749 9
- 03-5750 10
- 03-5751 11
- 03-5752 12
- 03-5753 13
- 03-5754 14
- 03-5755 15
- 03-5756 16
- 03-5757 17
- 03-5758 18
- 03-5759 19
- 03-5760 20
- 03-5761 21
- 03-5762 22
- 03-5763 23
- 03-5764 24
- 03-5765 25
- 03-5766 26
- 03-5767 27
- 03-5768 28
- 03-5769 29
- 03-5770 30

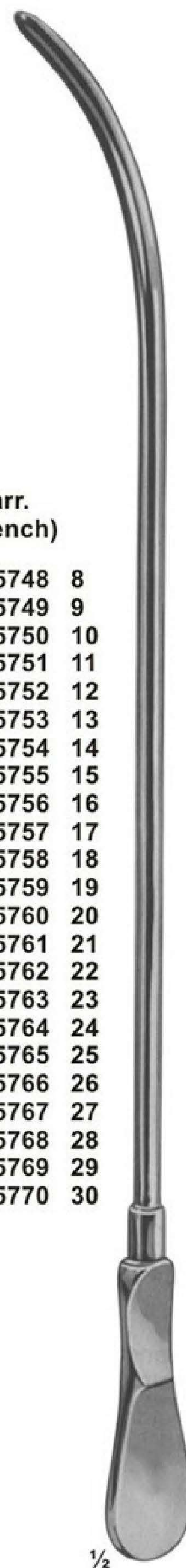

03-5748 - 03-5770
DITTEL
Urethral bougies
and dilating sounds
345 mm

- 03-5771 Ben. 24/Charr. 12
- 03-5772 Ben. 25
- 03-5773 Ben. 26/Charr. 13
- 03-5774 Ben. 27
- 03-5775 Ben. 28/Charr. 14
- 03-5776 Ben. 29
- 03-5777 Ben. 30/Charr. 15
- 03-5778 Ben. 31
- 03-5779 Ben. 32/Charr. 16
- 03-5780 Ben. 33
- 03-5781 Ben. 34/Charr. 17
- 03-5782 Ben. 35
- 03-5783 Ben. 36/Charr. 18
- 03-5784 Ben. 37
- 03-5785 Ben. 38/Charr. 19
- 03-5786 Ben. 39
- 03-5787 Ben. 40/Charr. 20
- 03-5788 Ben. 41
- 03-5789 Ben. 42/Charr. 21
- 03-5790 Ben. 43
- 03-5791 Ben. 44/Charr. 22
- 03-5792 Ben. 45
- 03-5793 Ben. 46/Charr. 23
- 03-5794 Ben. 47
- 03-5795 Ben. 48/Charr. 24
- 03-5796 Ben. 49
- 03-5797 Ben. 50/Charr. 25
- 03-5798 Ben. 51
- 03-5799 Ben. 52/Charr. 26
- 03-5800 Ben. 53
- 03-5801 Ben. 54/Charr. 27
- 03-5802 Ben. 55
- 03-5803 Ben. 56/Charr. 28
- 03-5804 Ben. 57
- 03-5805 Ben. 58/Charr. 29
- 03-5806 Ben. 59
- 03-5807 Ben. 60/Charr. 30



03-5771 - 03-5807
GUYON
Urethral bougies
and dilating sounds,
without filiform guides,
with thread in tip
255 mm

Genito-Urinary Instruments & Circumcision Clamps



03-5808
GUYON
Set of urethral bougies and dilating sounds, in metal case, with lift out rack and bottom rack, containing 21 urethral and dilating sounds, metal.

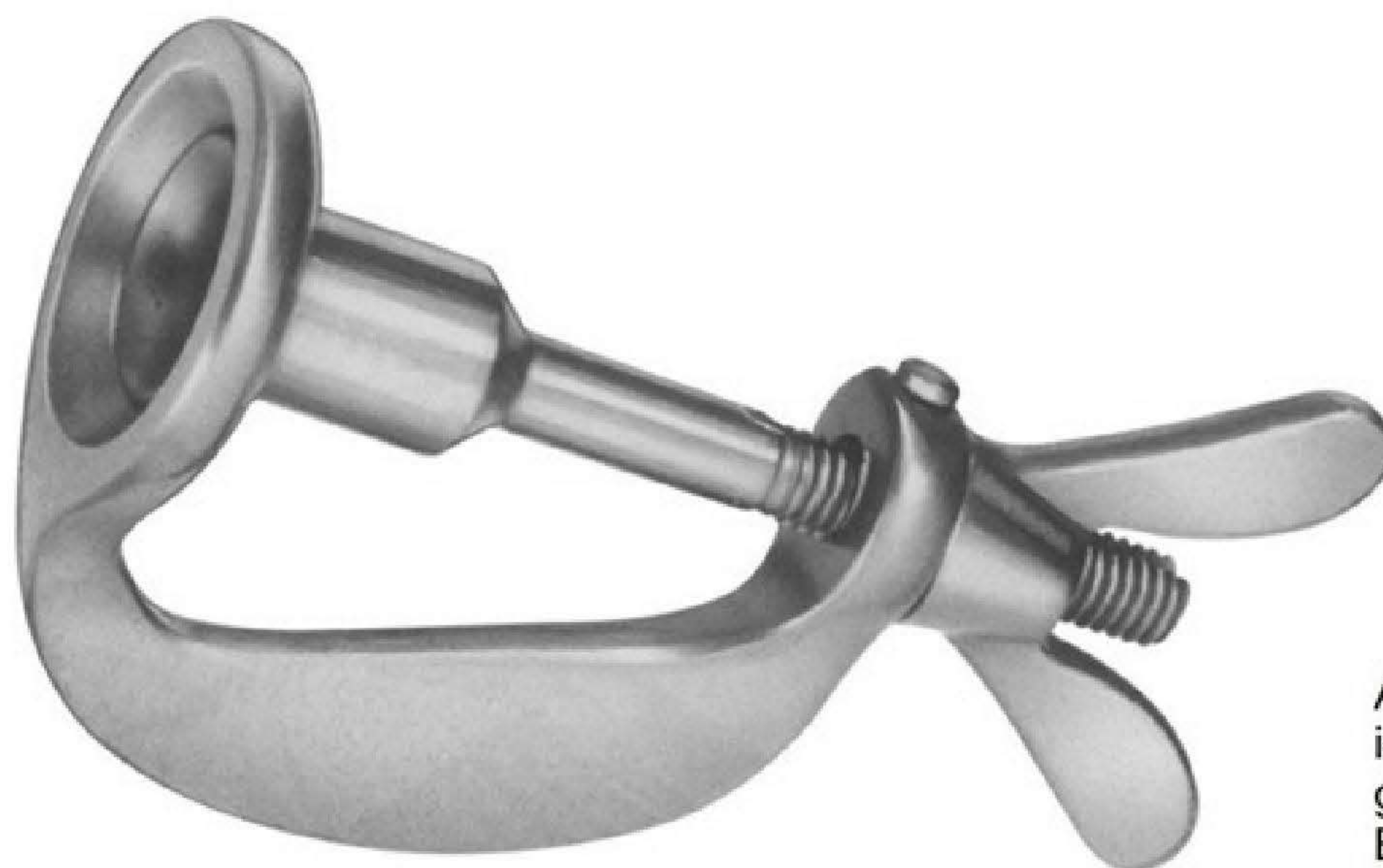

03-5809 - 03-5811
WINKELMANN
03-5809 ∅ 12mm
03-5810 ∅ 16mm
03-5811 ∅ 20mm

Circumcision Clamps

Assisted by two haemostats or ligatures the foreskin is pushed over the bellshaped protection - rod and the glans is placed into it. By now, the wing - nut is tightened as close as possible, so the foreskin in annular compressed. The foreskin is cut of with a scalpel, right next to the compression ring. The circumcision clamp remains a few minutes to avoid bleeding. In case that any large vein, specially the frenular artery, is cut through, a ligature must be set. The advantage of the method described is the cosmeticy favourable scar which is left after rejection of the small necrotized portion.

Trocars

Luer Lock



03-5812
KLIMA ROSEGGER
35 X 1,8 mm
Sternal puncture needle

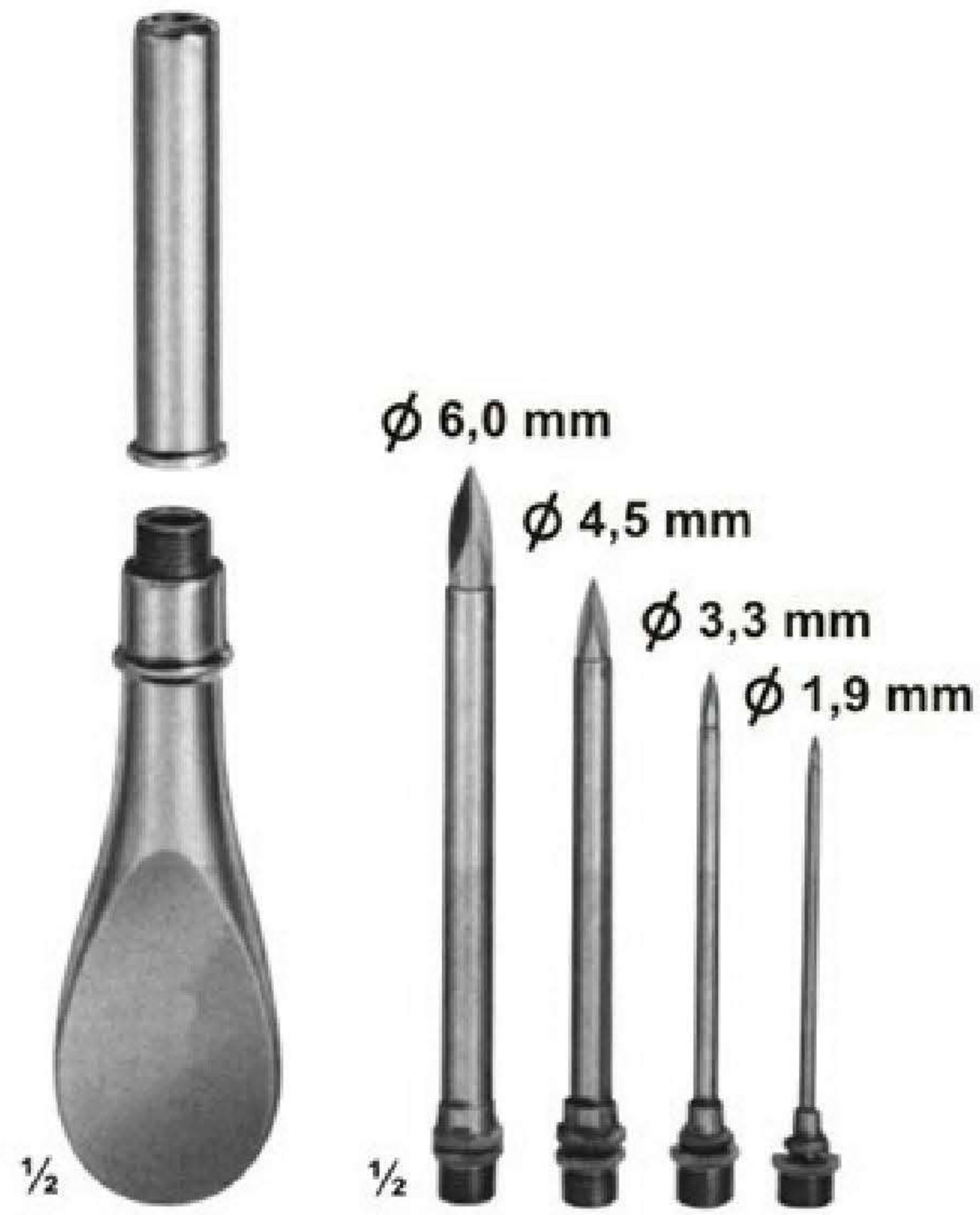

03-5813
Universal trocar
with 4 tips



03-5814 - 03-5818
NELSON

	Inside diam	Outside diam
03-5814	2,2 mm	3,0 mm
03-5815	3,0 mm	4,0 mm
03-5816	4,0 mm	5,0 mm
03-5817	5,0 mm	6,0 mm
03-5818	5,5 mm	6,5 mm

for hydrocele and abdominal puncture



03-5819 - 03-5822

	Inside diam	Outside diam
03-5819	2,2 mm	3,0 mm
03-5820	3,0 mm	4,0 mm
03-5821	4,0 mm	5,0 mm
03-5822	5,0 mm	6,0 mm

for abdominal puncture,
with stop-cock and lateral drain

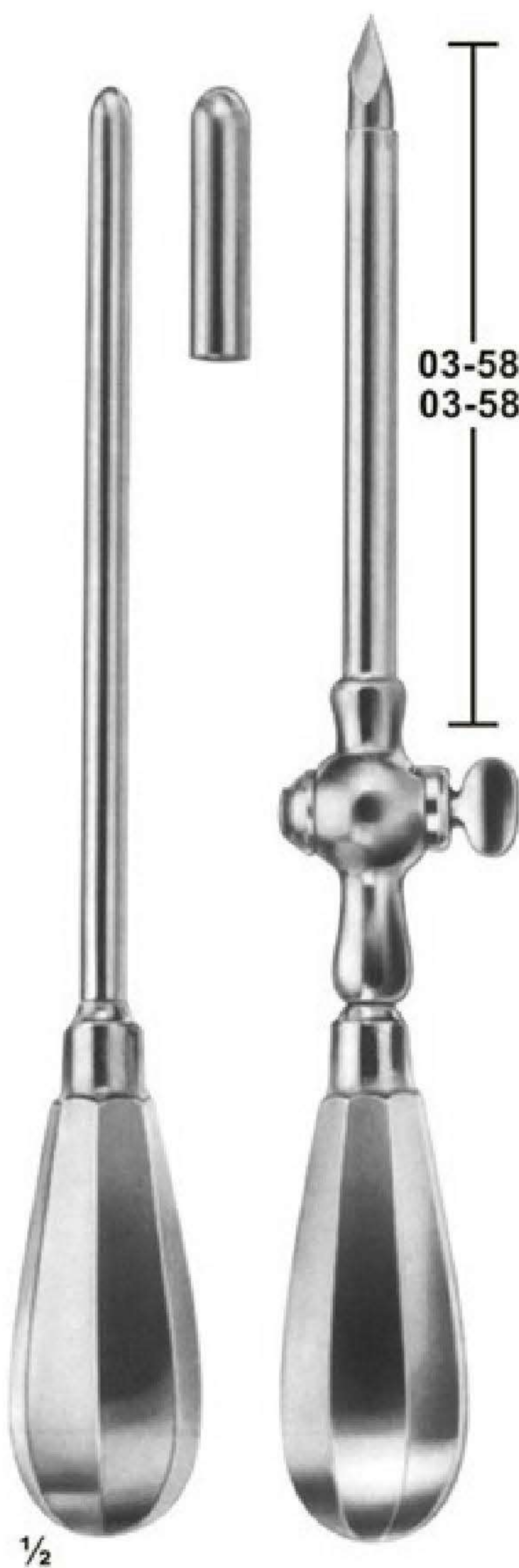

03-5823 100 mm
03-5824 110 mm

03-5823 - 03-5824
BUELAU

	Inside diam	Outside diam
03-5823	6,5 mm	8,0 mm
03-5824	9,0 mm	10,0 mm

Empyema trocar

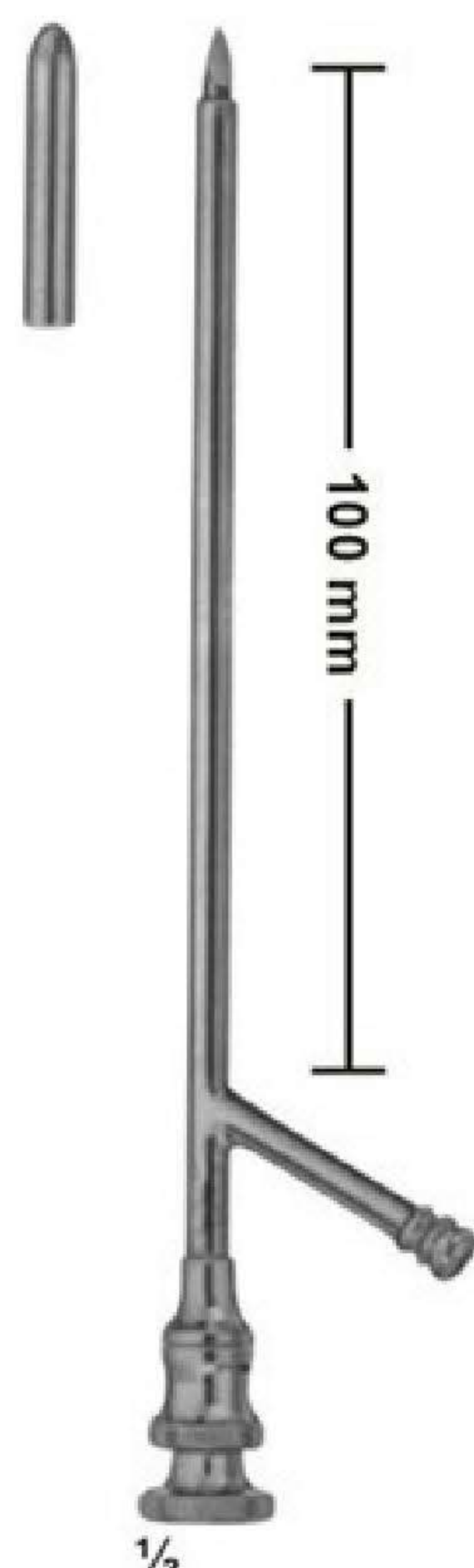

03-5825 - 03-5828
OCHSNER

	Inside diam	Outside diam
03-5825	3,0 mm	4,0 mm
03-5826	3,6 mm	4,6 mm
03-5827	4,3 mm	5,3 mm
03-5828	5,0 mm	6,0 mm

Gall bladder trocars

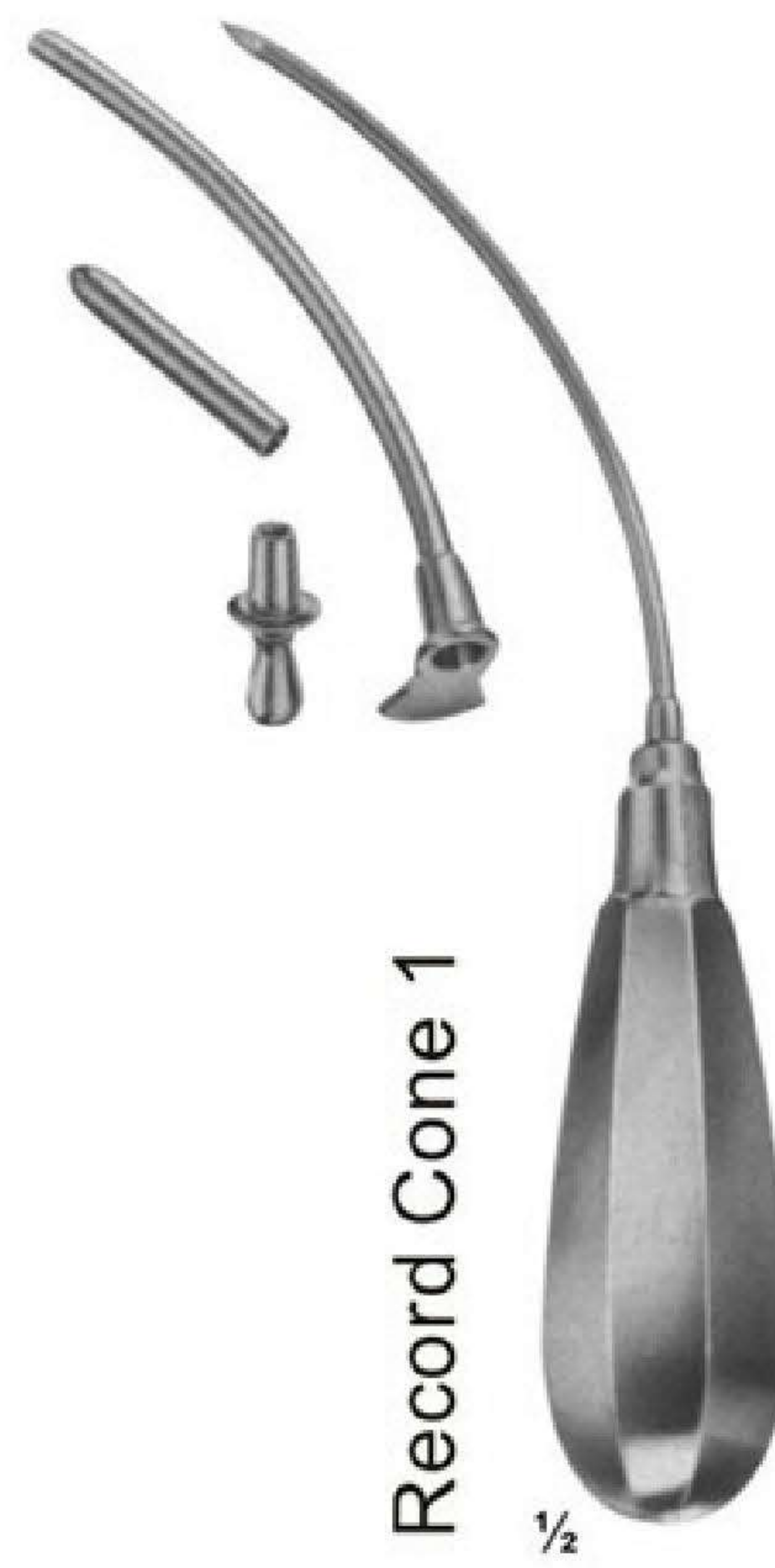

03-5829
PIERCE
Antrum trocar
ø 4,0 mm



03-5830
COAKLEY
Antrum trocar
ø 3,0 mm