

Nerve - and Vessel Hooks

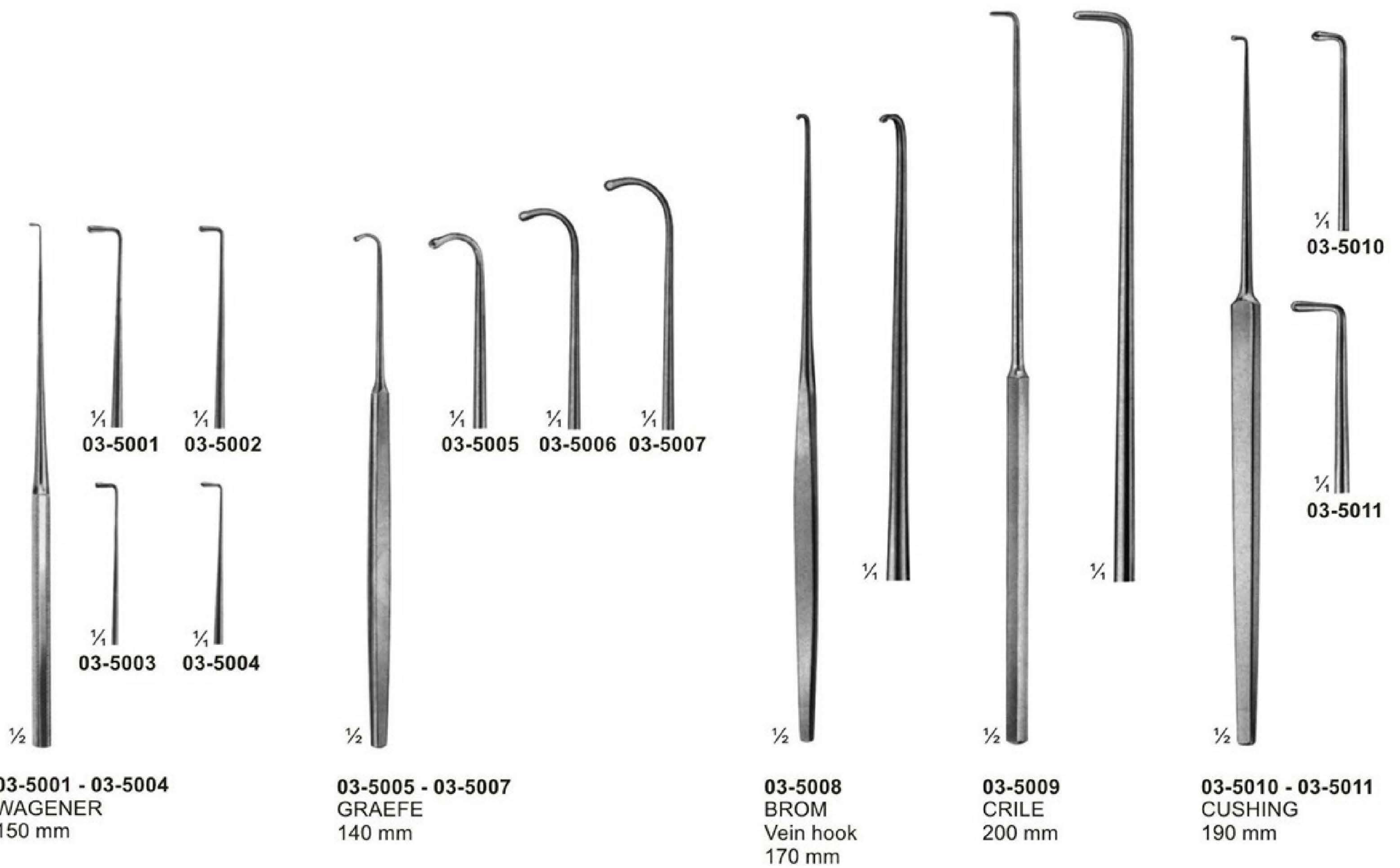

Nerve - and Vessel Hooks

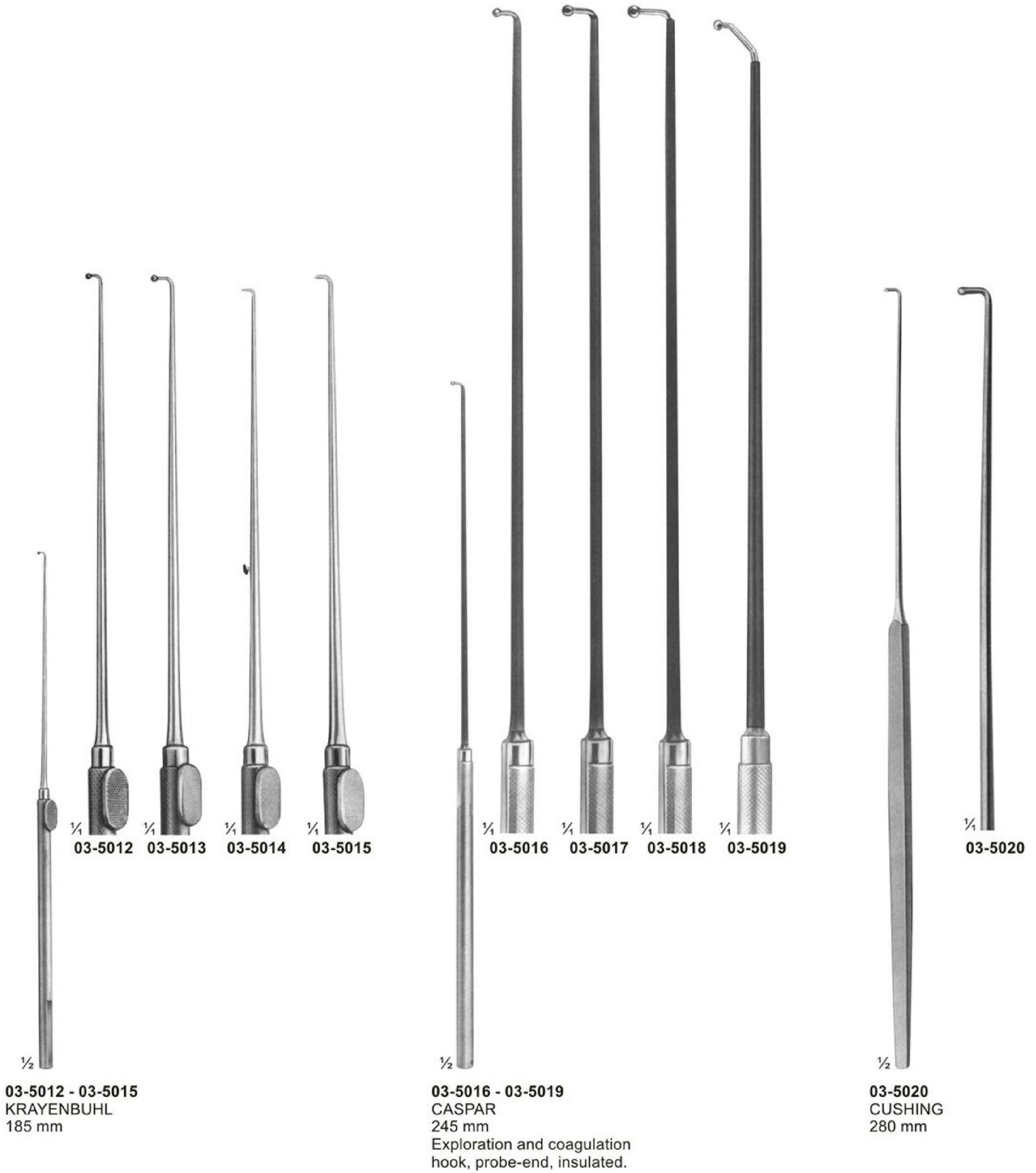

Fine Wound Retractors (Dura- and Skin Retractors)

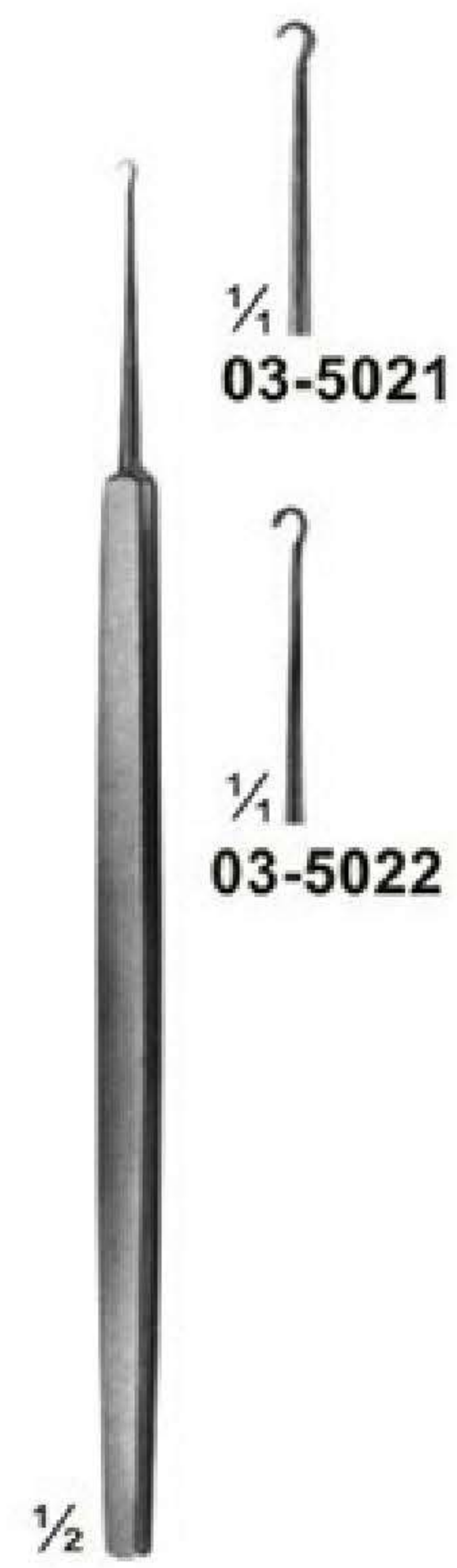

03-5021 - 03-5022
03-5021 Sharp
03-5022 Blunt
GRAEFE
125 mm



03-5023 - 03-5024
03-5023 125 mm
03-5024 130 mm
Sharp
GUTHRIE



03-5025 - 03-5027
03-5025 130 mm
03-5026 135 mm
Sharp
03-5027 135 mm
Blunt
ROLLET

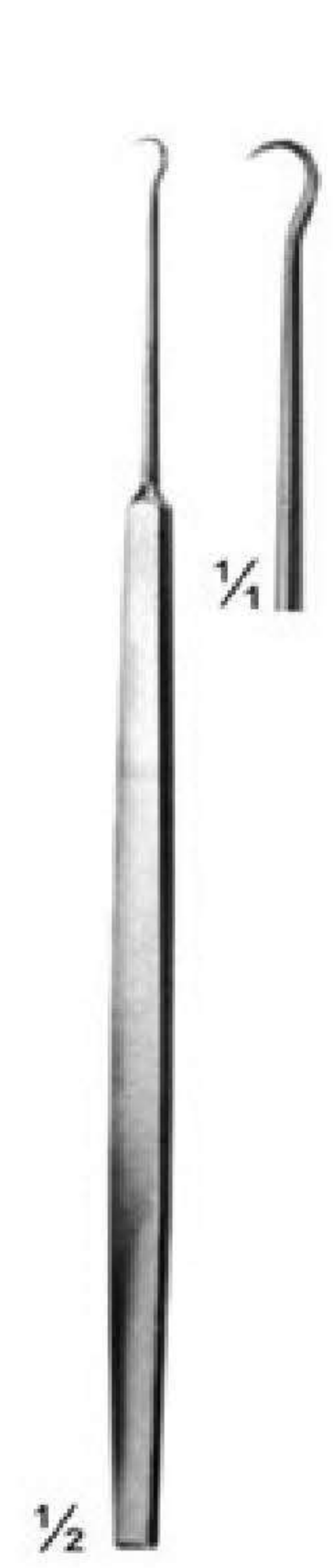

03-5028
FRAZIER
Dura Retractor
130 mm

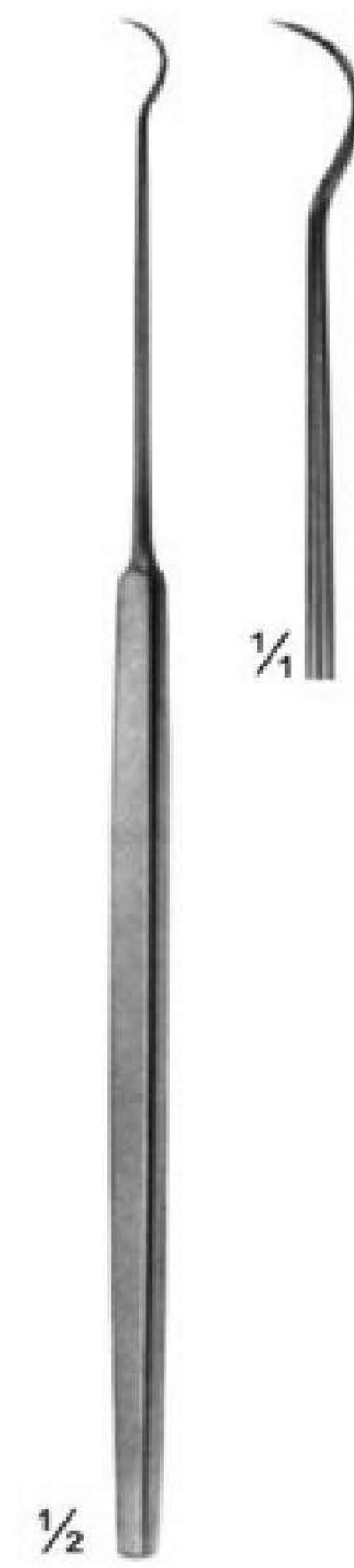

03-5029
TOENNIS
Dura Retractor
150 mm

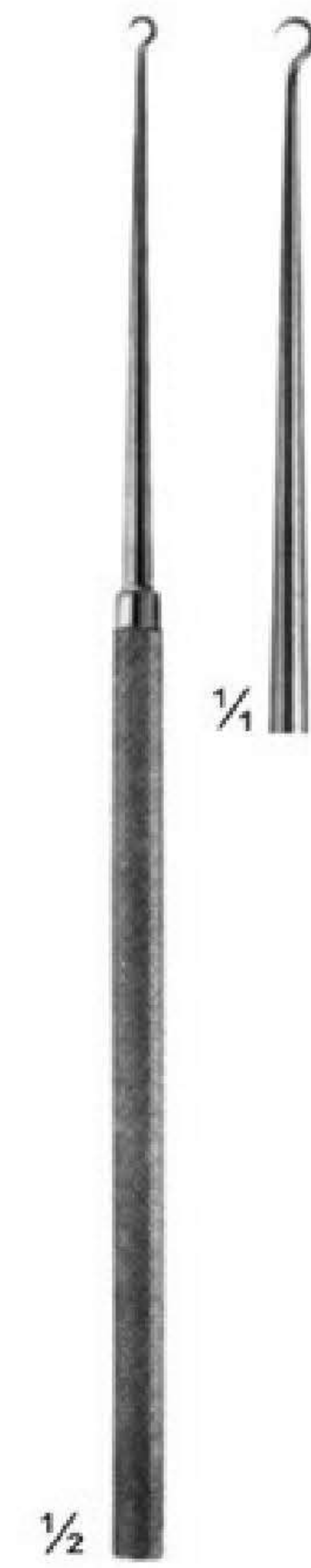

03-5030
KILNER
160 mm

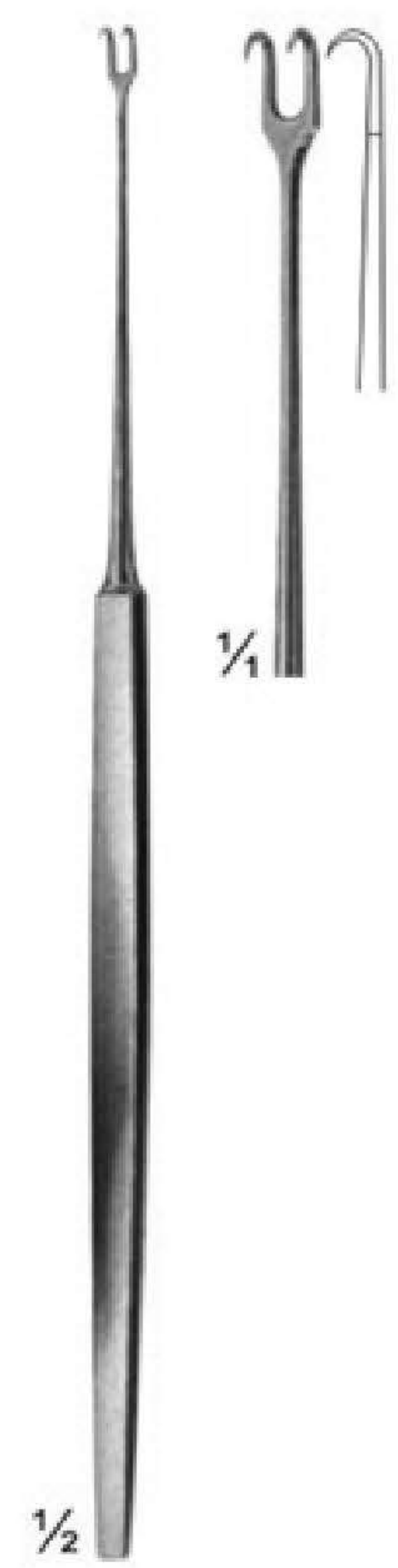

03-5031
FREER
150 mm

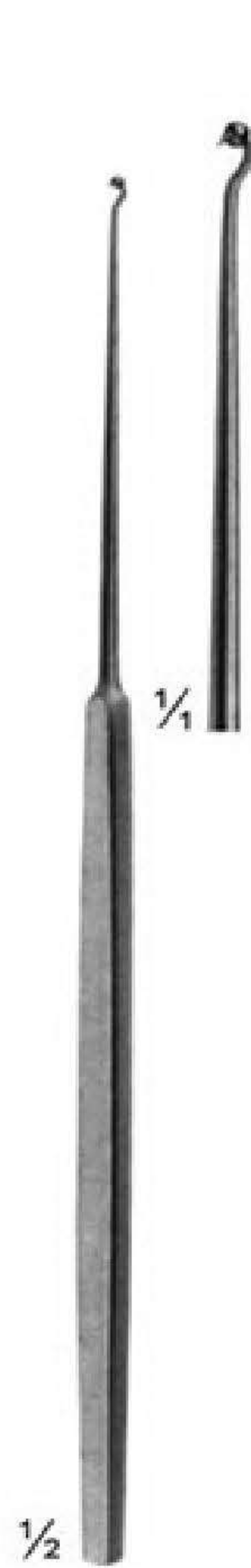

03-5032
MULLER
150 mm



03-5033
MULLER
150 mm

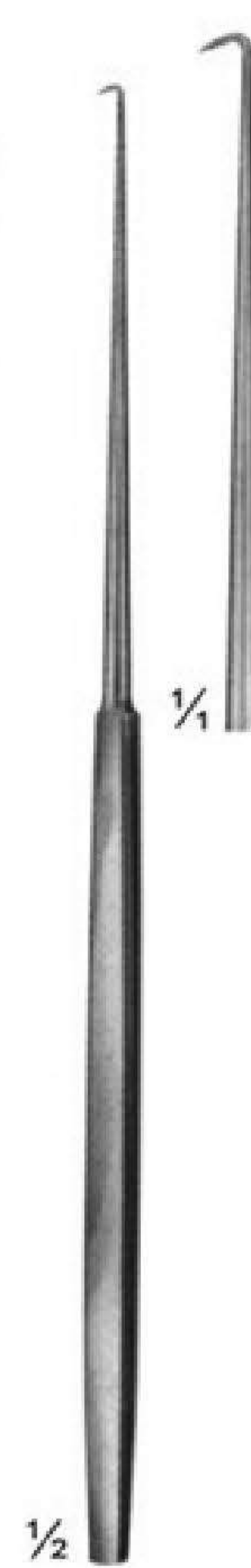

03-5034
COTTLE
160 mm



03-5035
COTTLE
160 mm

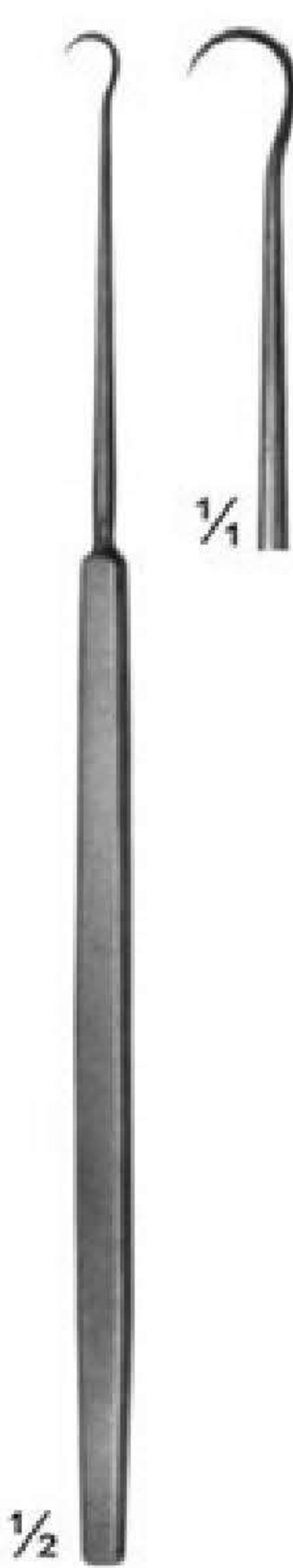

03-5036
JAEGER
135 mm



03-5037 - 03-5040
JOSEPH
165 mm



03-5037

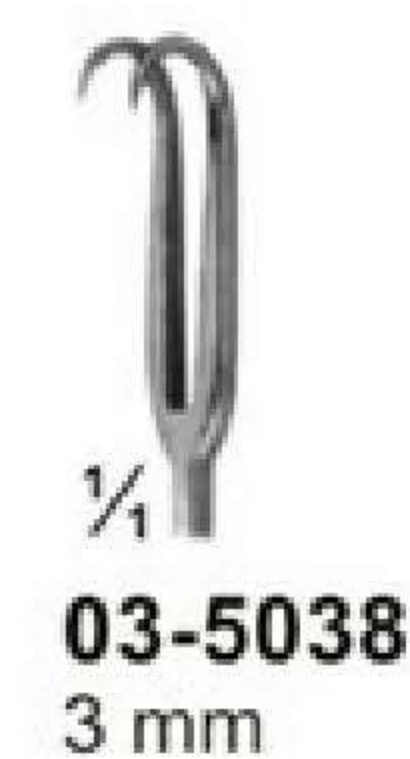

03-5038
3 mm

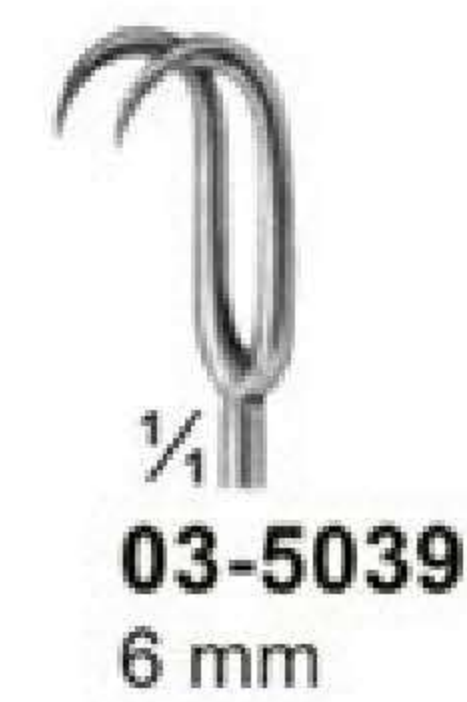

03-5039
6 mm

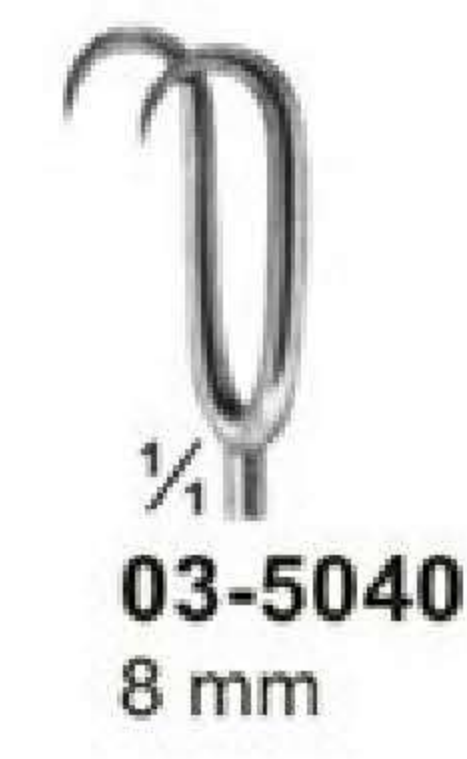

03-5040
8 mm



03-5041

03-5042

3 X 11 mm

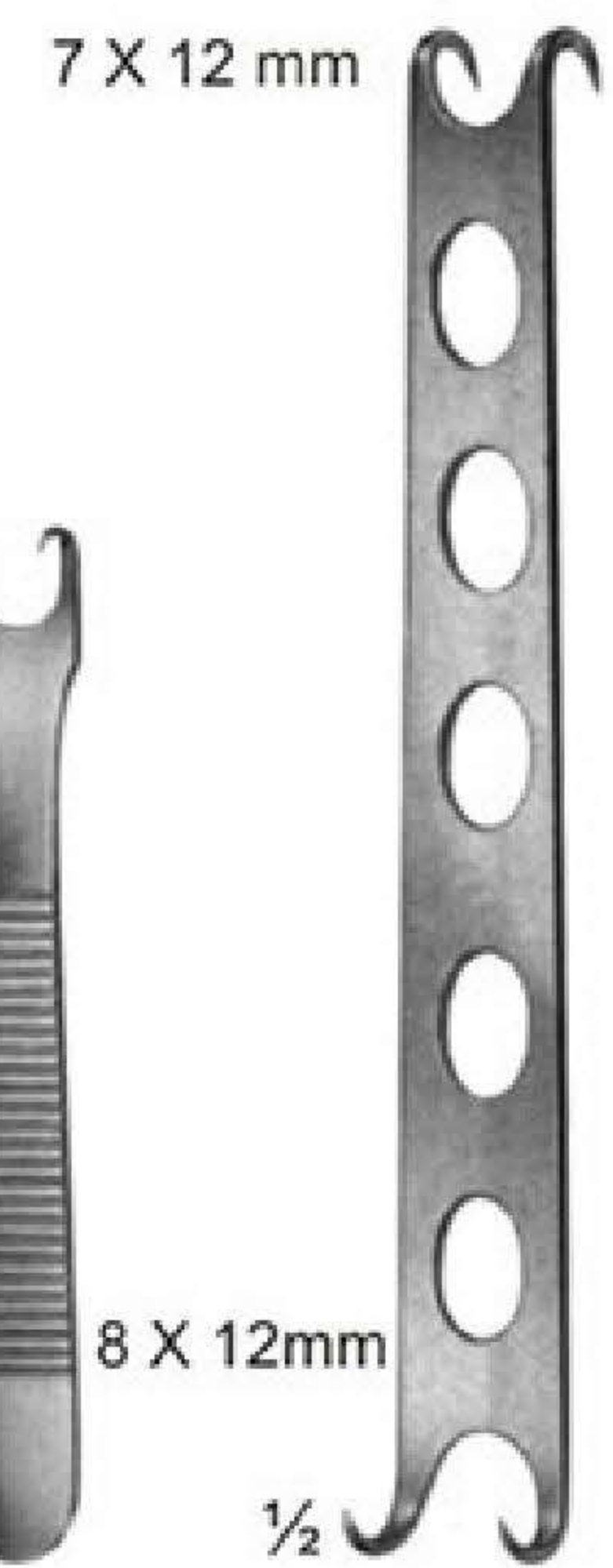

7 X 12 mm

8 X 12mm

03-5044
CONVERSE
Blunt
120 mm

Wound - Trachea Retractors

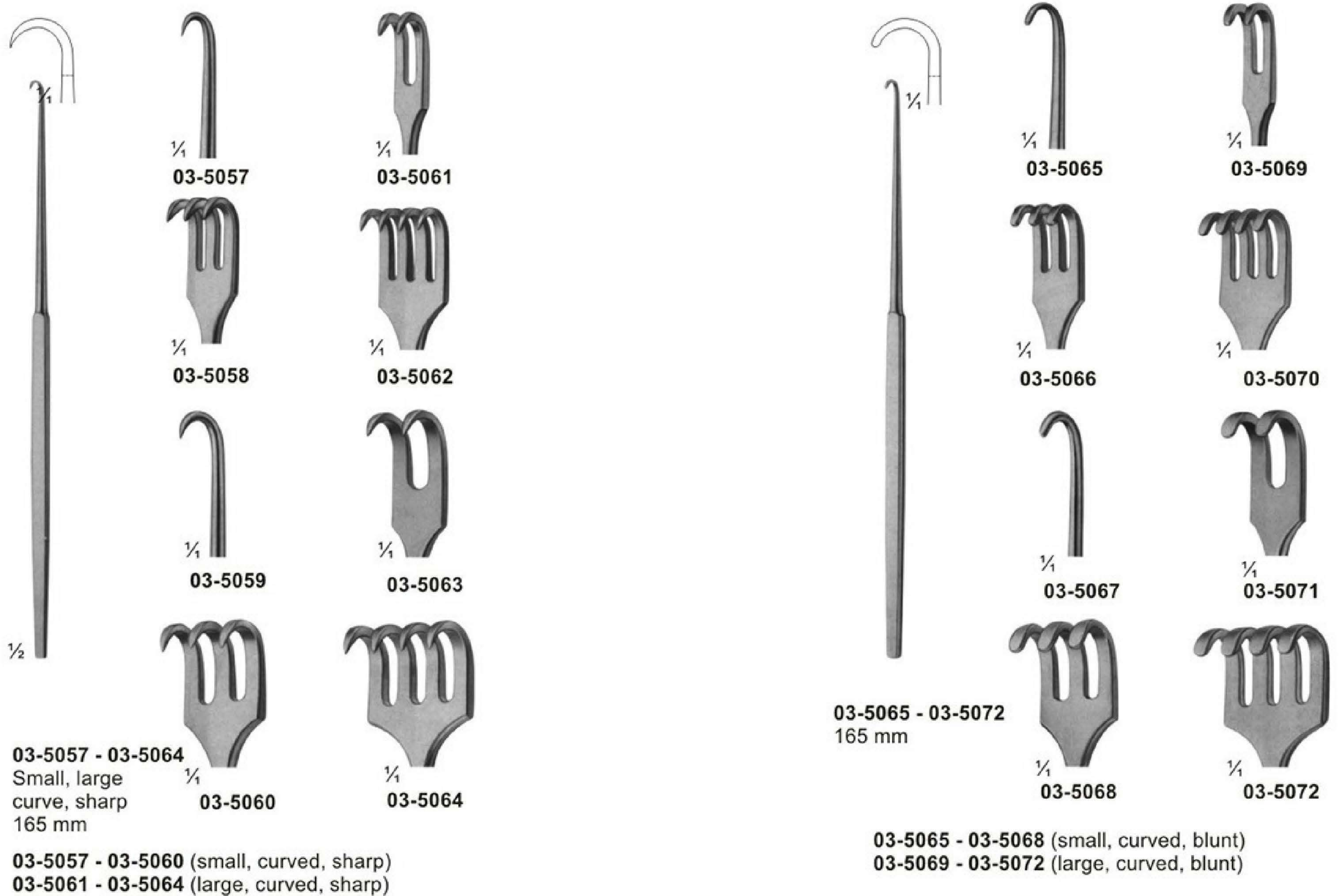

Retractors With Treangle Handle

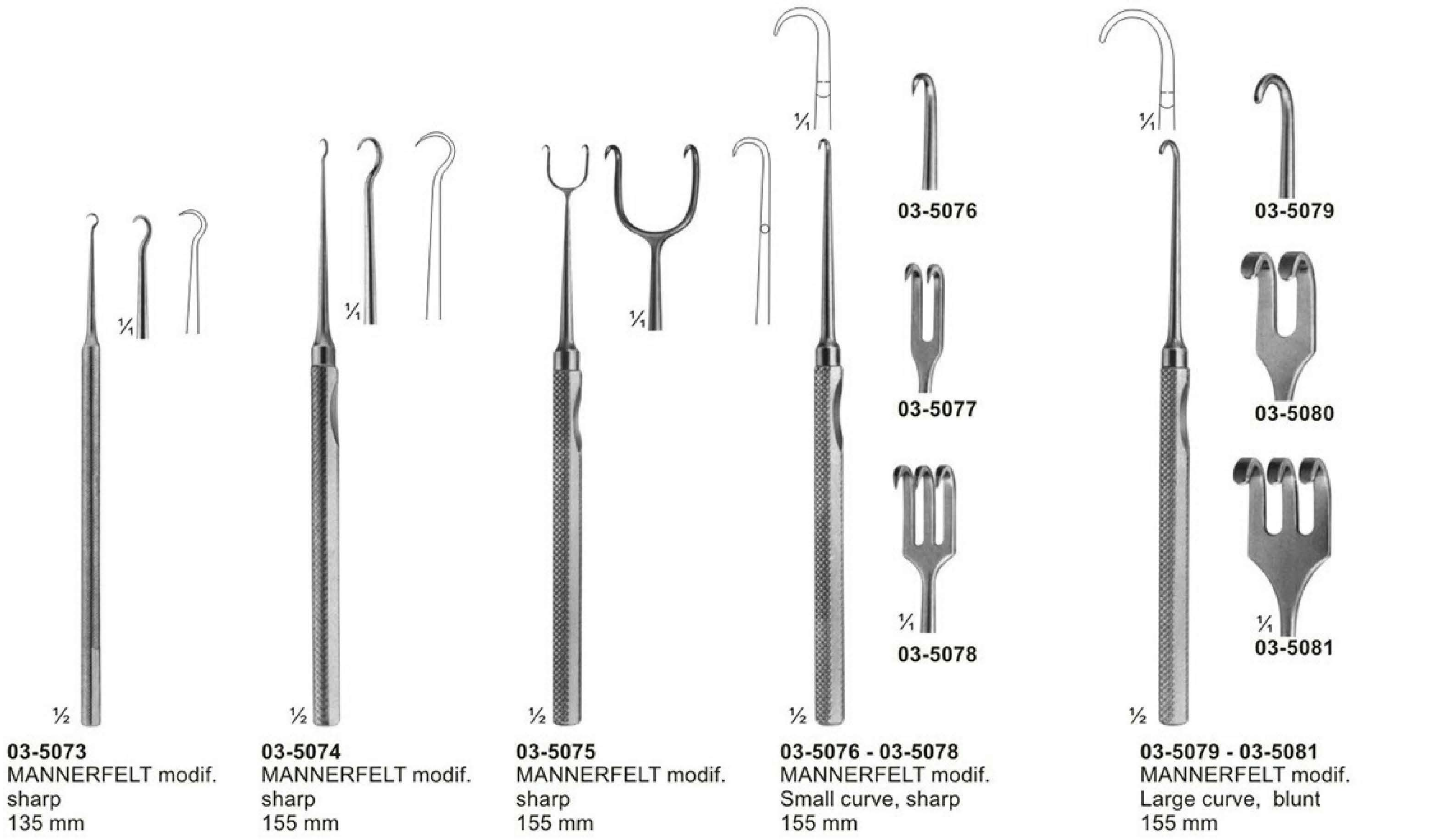

03-5073
 MANNERFELT modif.
 sharp
 135 mm

03-5074
 MANNERFELT modif.
 sharp
 155 mm

03-5075
 MANNERFELT modif.
 sharp
 155 mm

03-5076 - 03-5078
 MANNERFELT modif.
 Small curve, sharp
 155 mm

03-5079 - 03-5081
 MANNERFELT modif.
 Large curve, blunt
 155 mm



03-5082 - 03-5085
 LANGENBECK-
 MANNERFELT modif.
 155 mm

03-5086 - 03-5088
 MANNERFELT modif.
 Saddle hooks,
 155 mm

03-5089
 MANNERFELT modif.
 Saddle hooks, fenestrated
 155 mm

Retractors

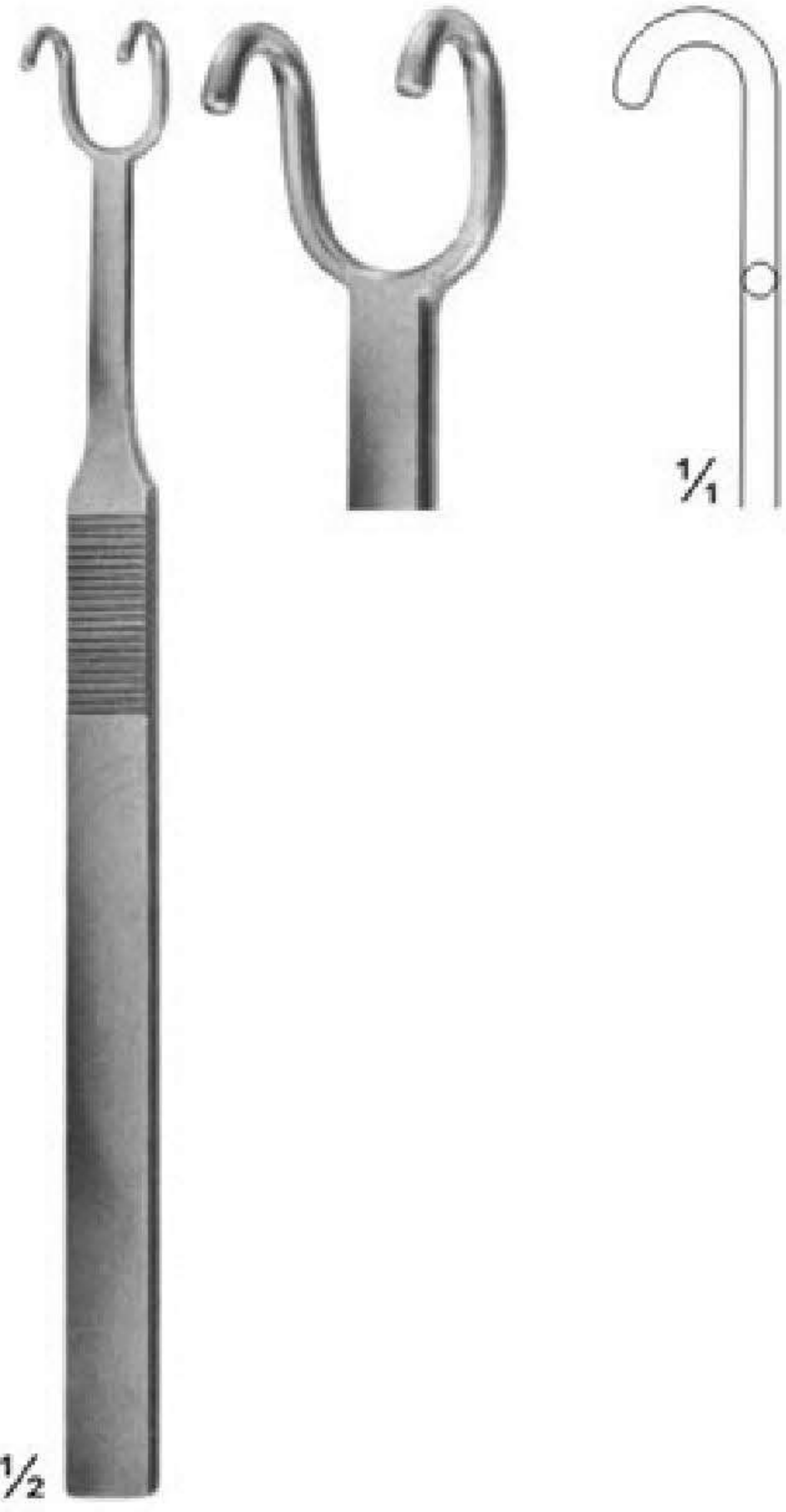

03-5090
 FOMON
 145 mm



03-5091 - 03-5092
 160 mm



03-5093 - 03-5094
 LANGENBECK-GREEN
 160 mm



03-5095
 160 mm

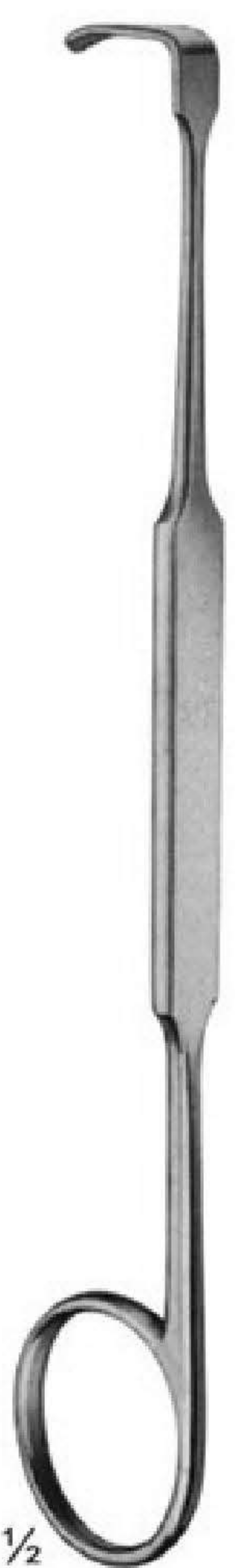

03-5096 - 03-5101
 MEYERDING
 Fig. A - Fig. F
 180 mm



03-5096
 18 x 7 mm



03-5097
 16 x 5 mm

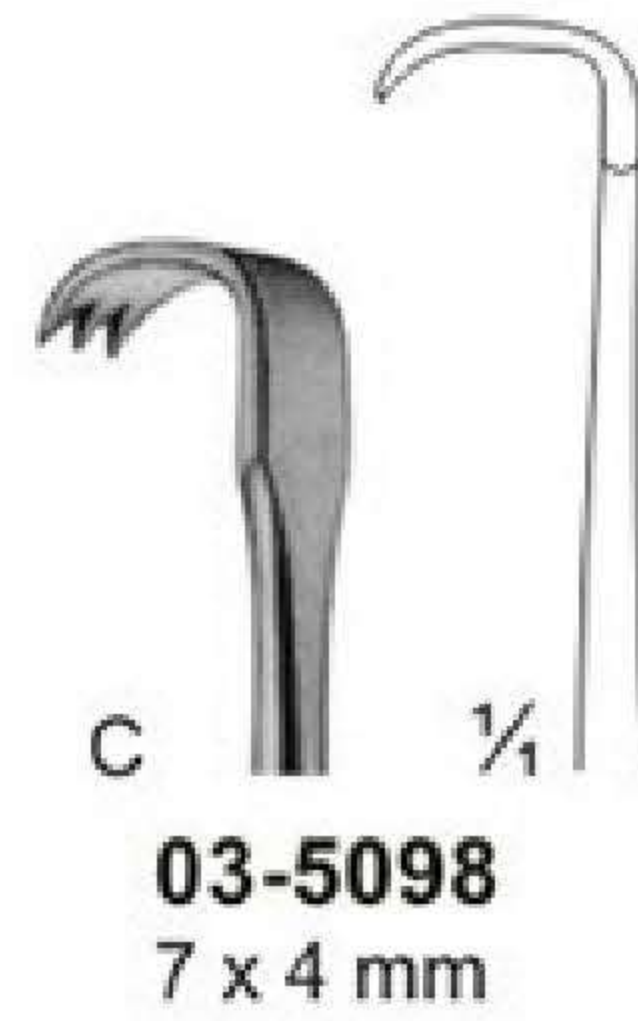

03-5098
 7 x 4 mm

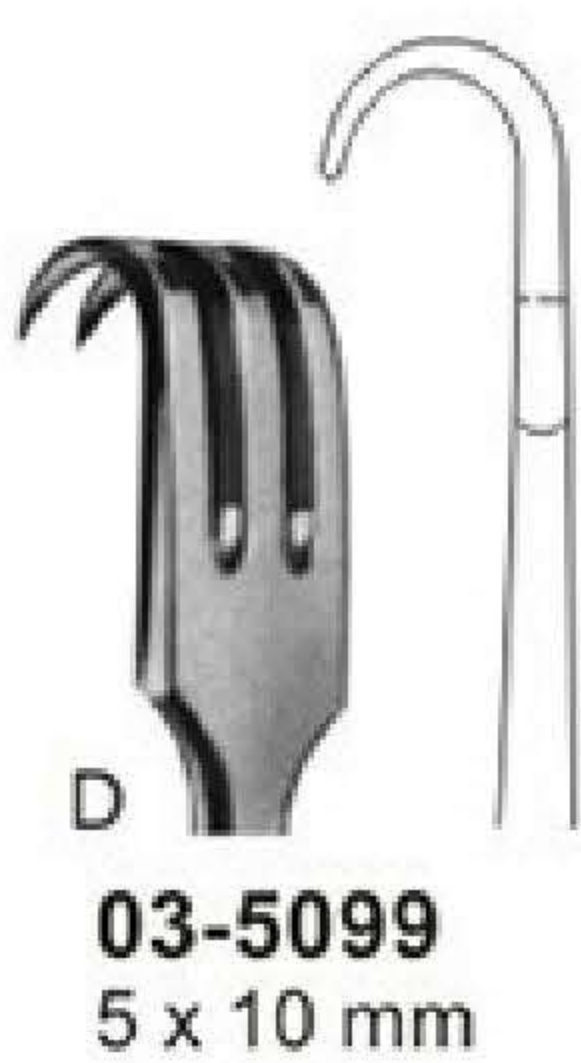

03-5099
 5 x 10 mm



03-5100
 11 x 4 mm

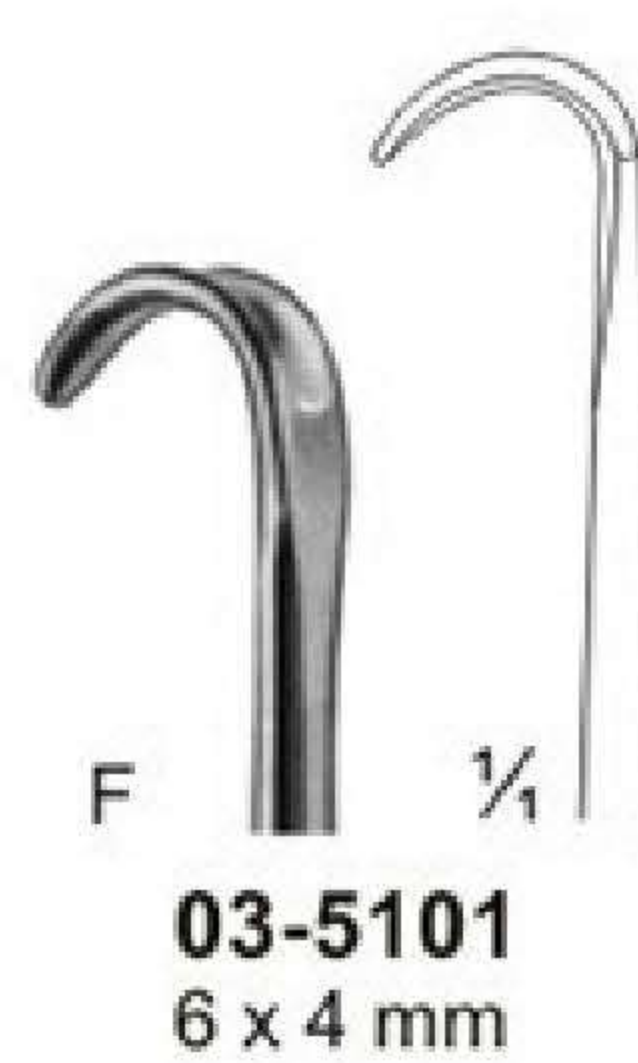

03-5101
 6 x 4 mm

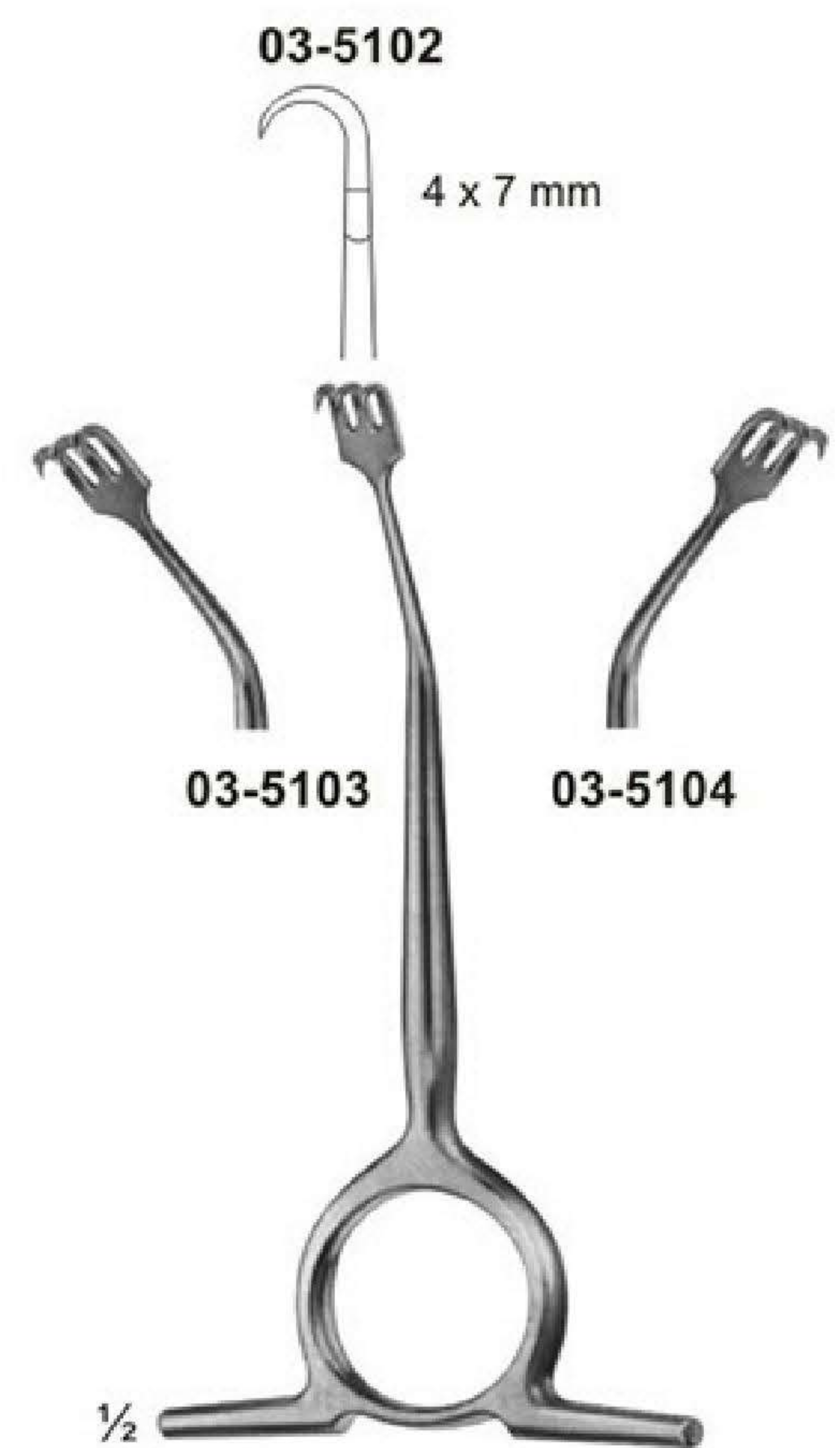

03-5102
 4 x 7 mm

03-5103

03-5104

03-5102 - 03-5104
 WILLIGER
 120 mm

Retractors

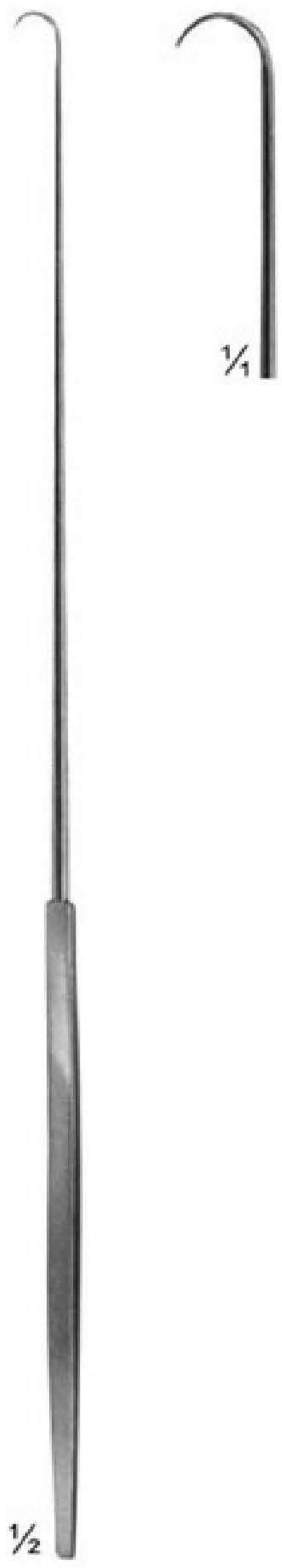

03-5105
 EMMET
 Fistula hook
 220 mm



03-5106
 SIMON
 Fistula hook
 220 mm

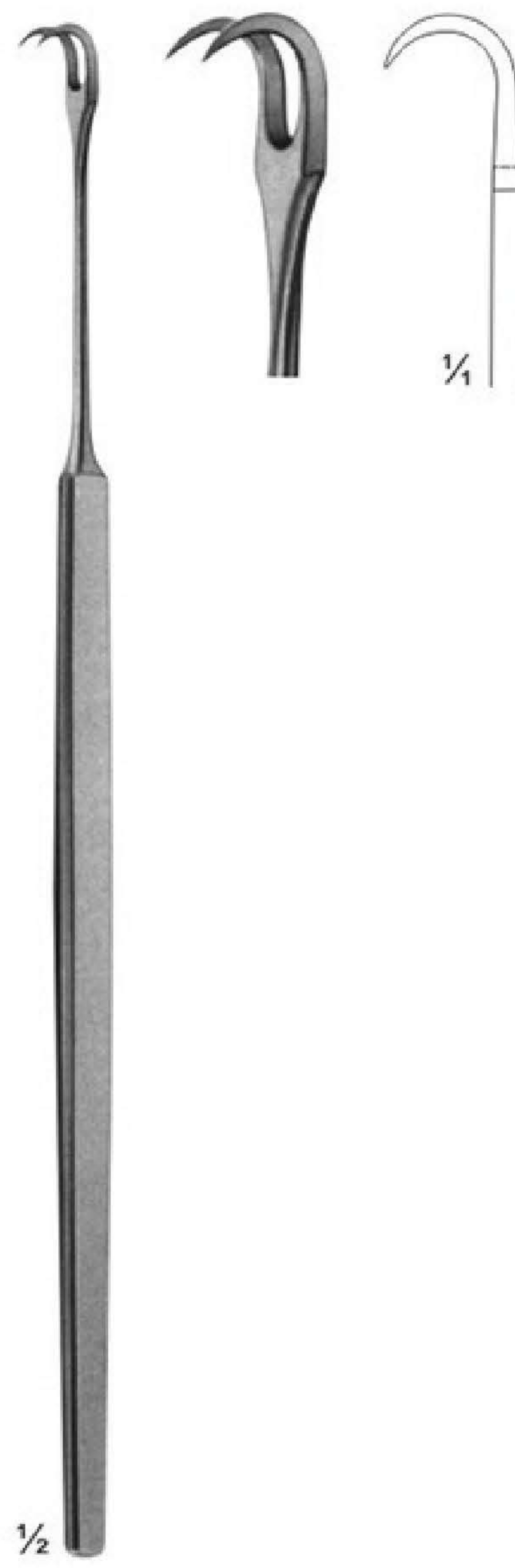

03-5107
 SIMON
 Fistula hook
 220 mm



03-5108
 LANGE
 Fistula hook
 230 mm



03-5109 - 03-5110
 Tendon hooks
 175 mm

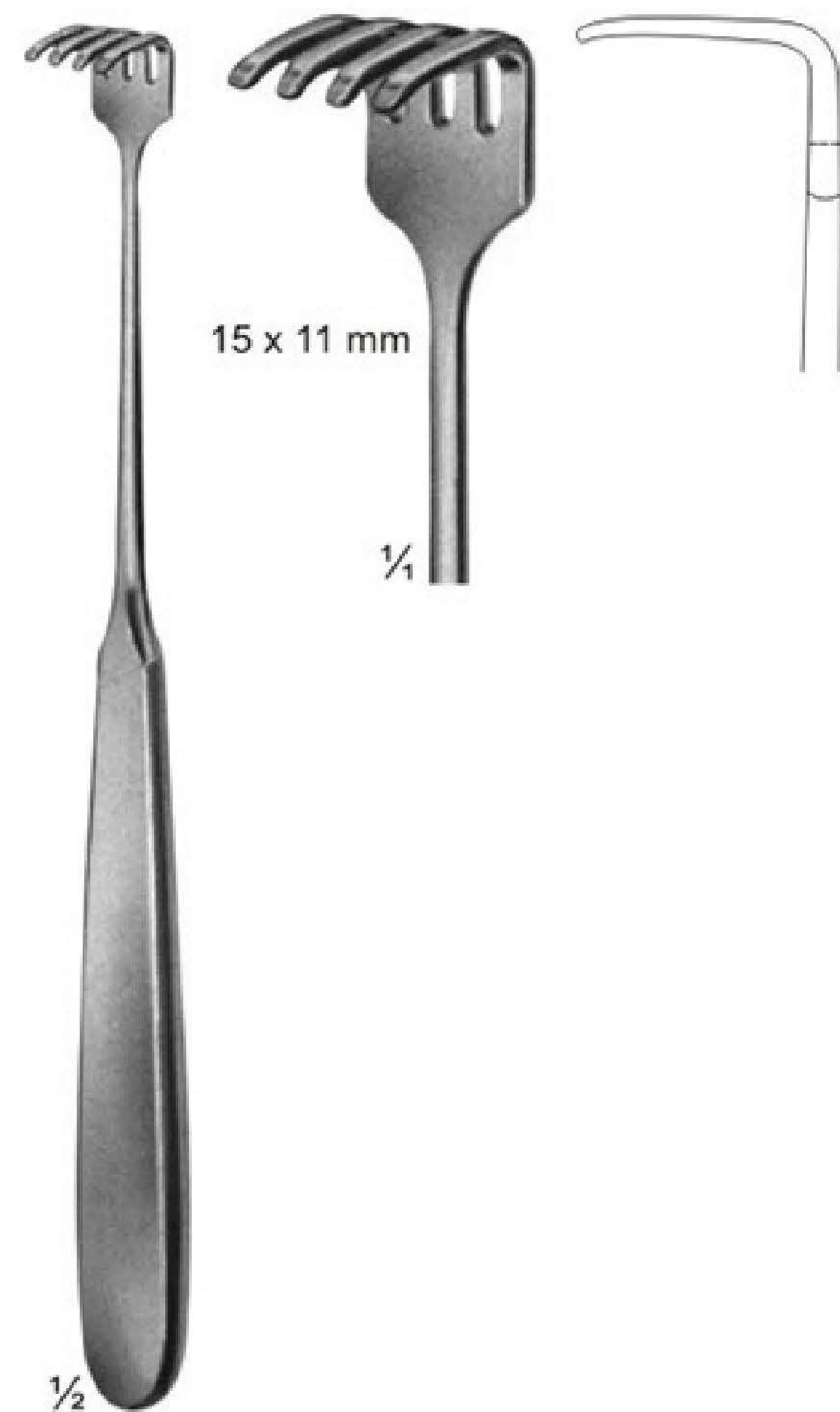

03-5111
 KLAPP
 Tendon hooks
 175 mm

Wound and Vein Retractors

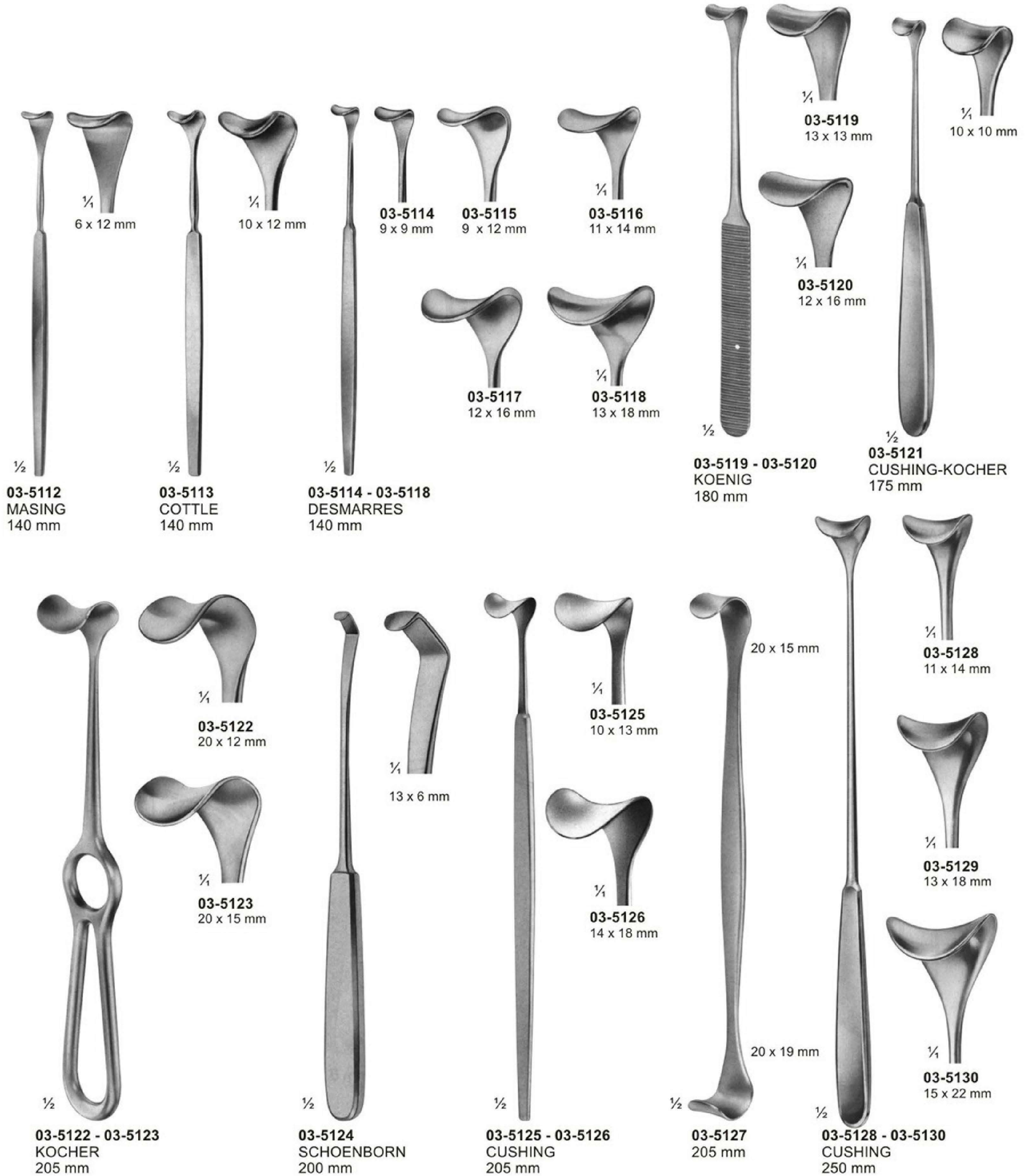

Retractors



03-5131 - 03-5132
BABY-SENN-MILLER
155 mm

03-5133
SENN-MILLER
165 mm

03-5134
COLLIN-HARTMANN
150 mm

03-5135 - 03-5137
STERNBERG
03-5135 120 mm
03-5136 130 mm
03-5137 135 mm

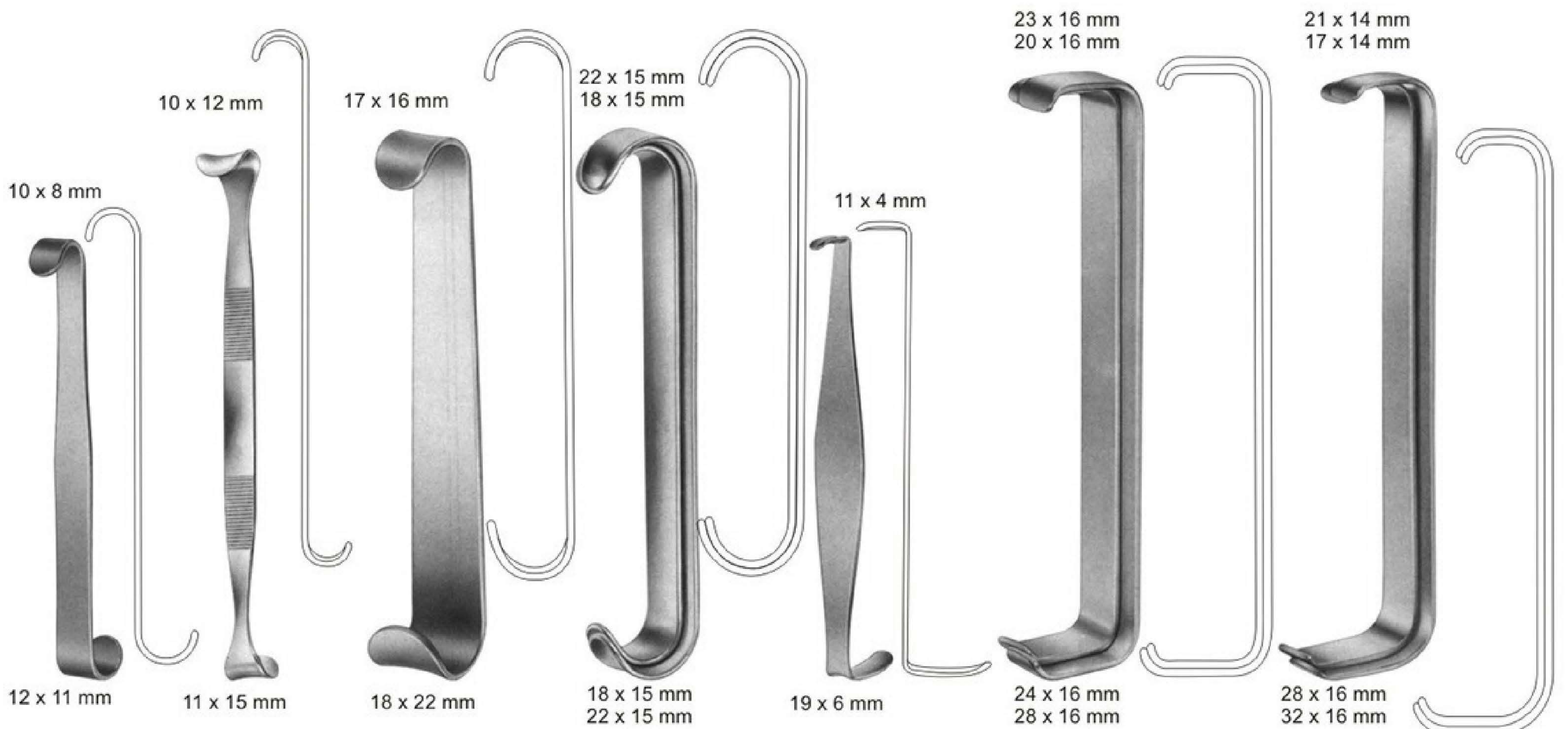

03-5138
LUER
110 mm

03-5139
ROSE
130 mm

03-5140
BABY-ROUX
135 mm

03-5141
PARKER
135 mm

03-5142
CRILE
110 mm

03-5143
FARABEUF
150 mm

03-5144
COLLIN
150 mm

Retractors

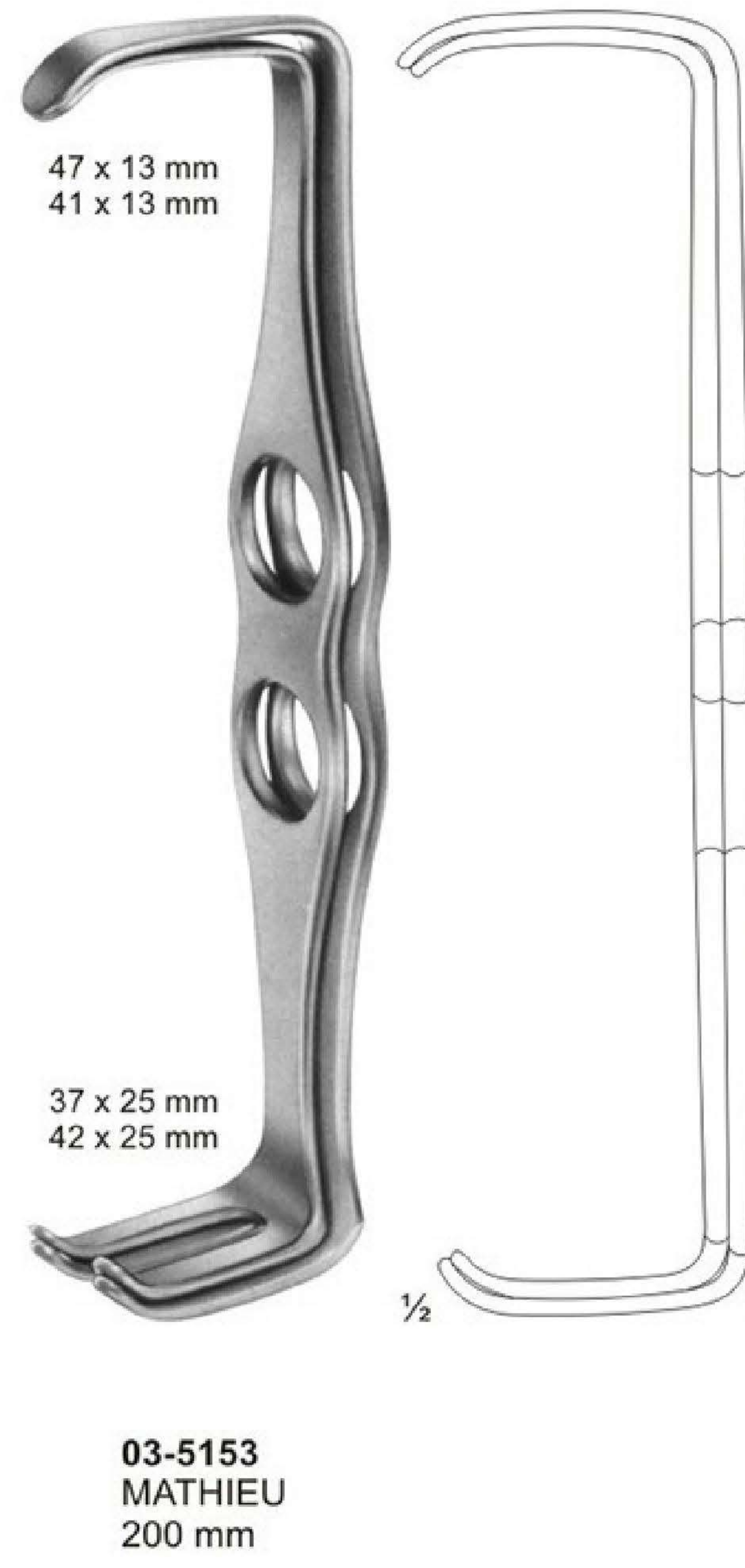
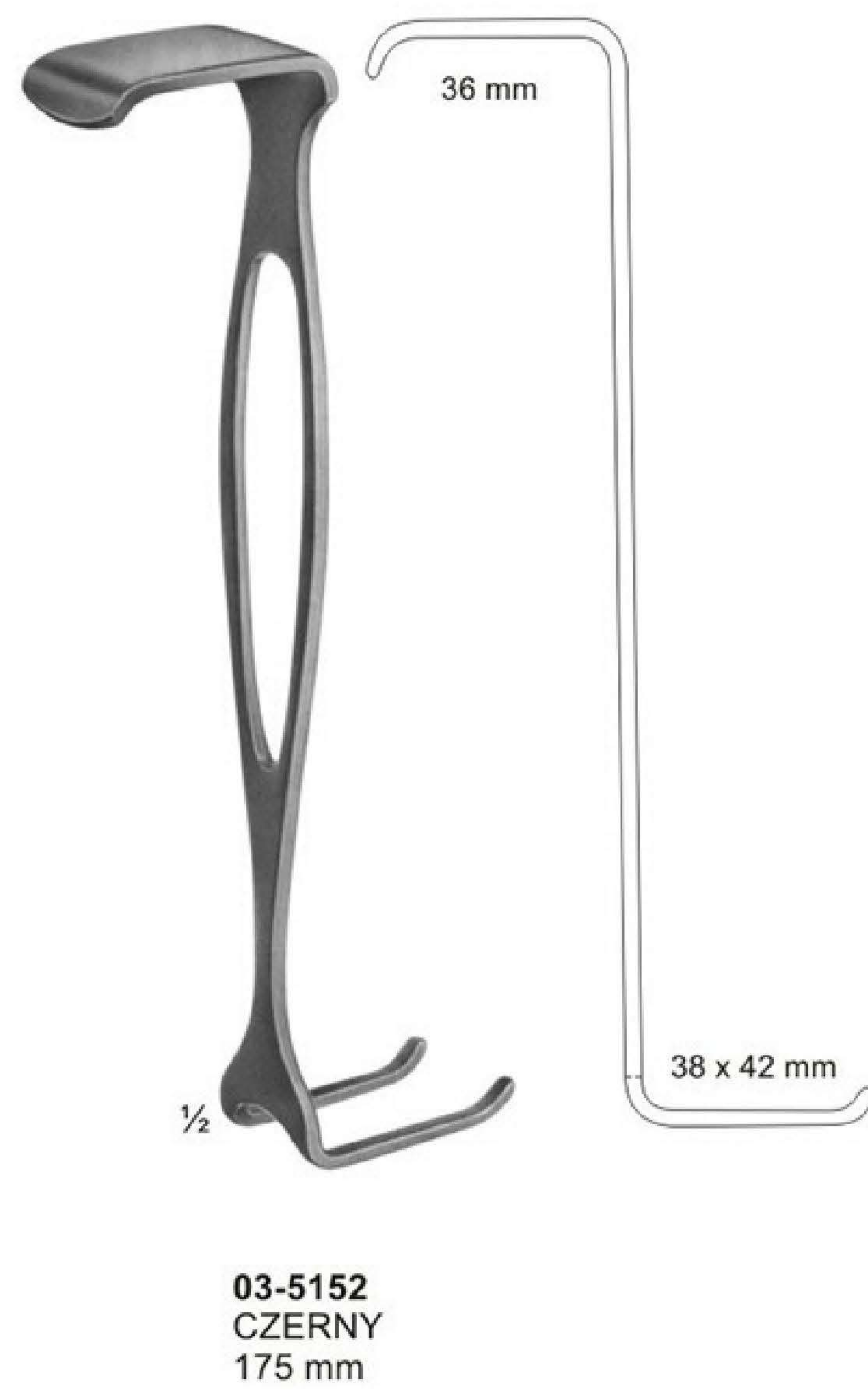
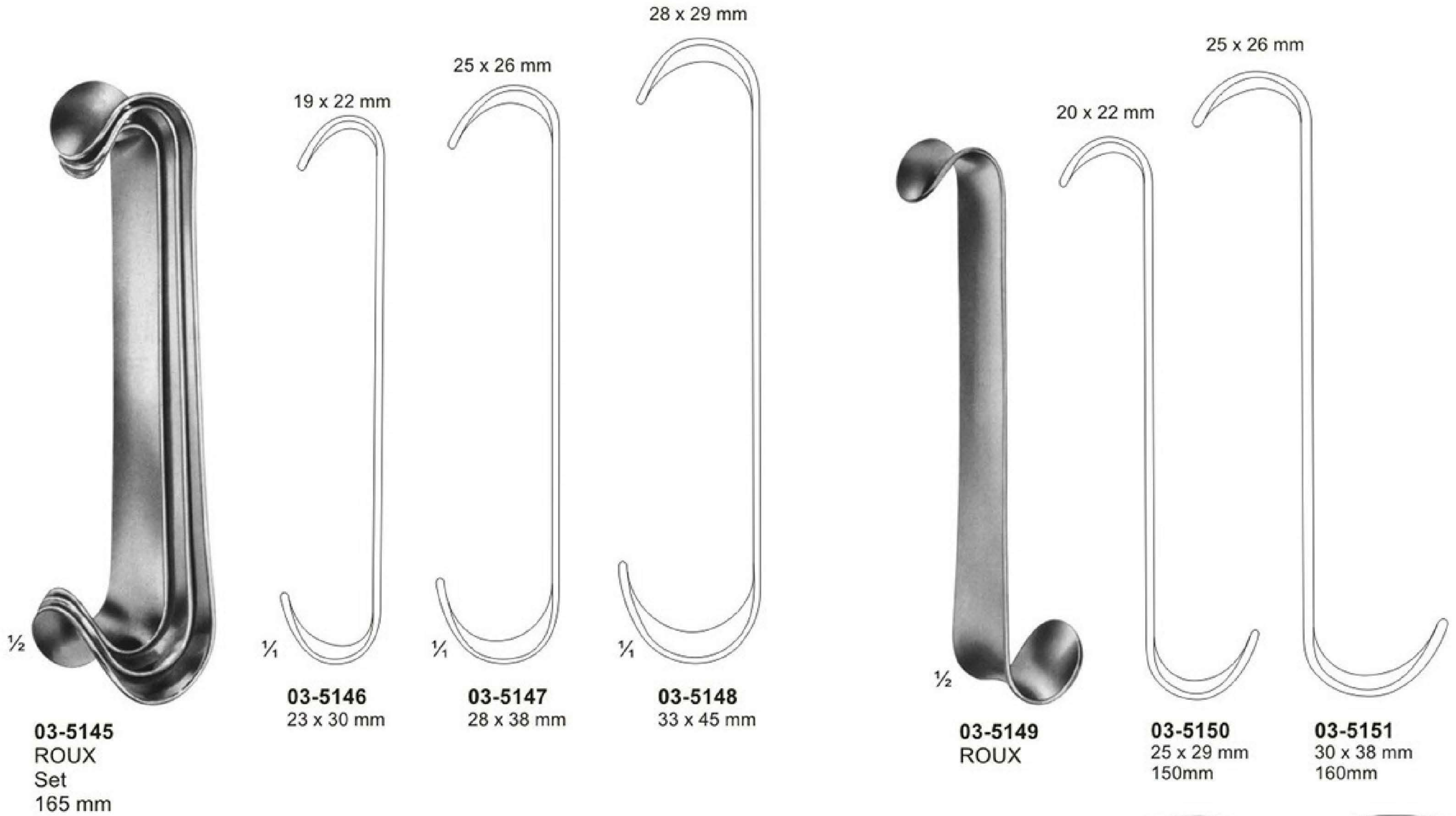

Bone Retractors and Retractors



03-5155
KOCHER
Sharp
205 mm



03-5156
KOCHER
Sharp
220 mm



03-5157
VOLKMANN
Sharp
220 mm



03-5158
VOLKMANN
Blunt
220 mm



03-5159
VOLKMANN
Sharp
220 mm



03-5160 - 03-5167
VOLKMANN
225 mm

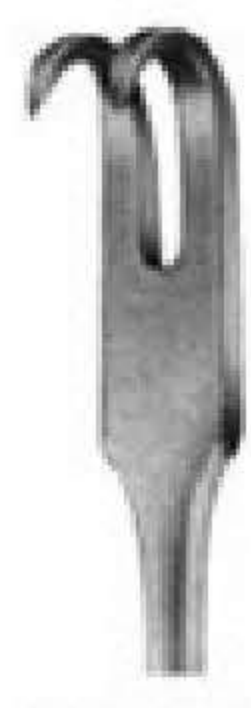
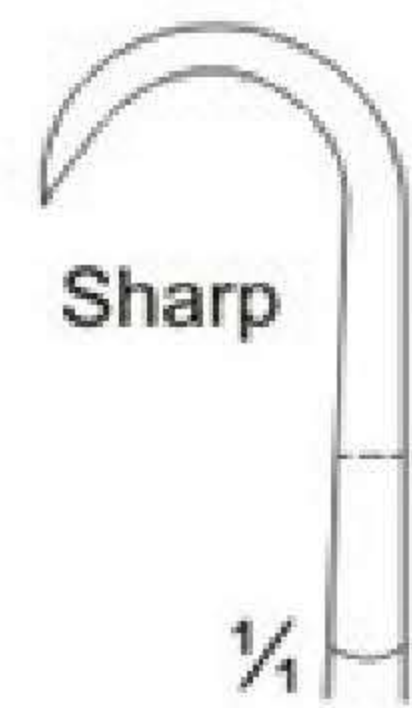

03-5160
9 x 8 mm



03-5161
9 x 13 mm



03-5162
9 x 19 mm



03-5163
9 x 29 mm
 $\frac{1}{2}$

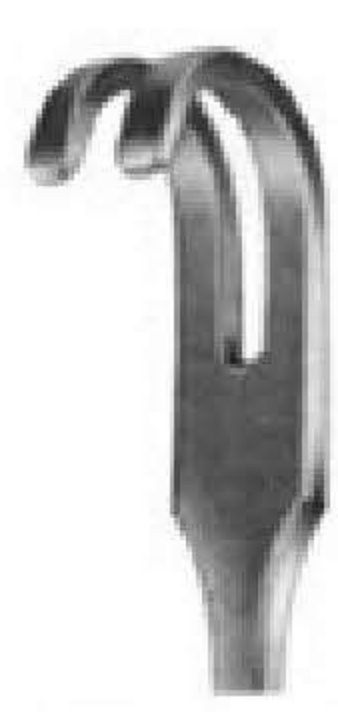

03-5164
8,5 x 8 mm

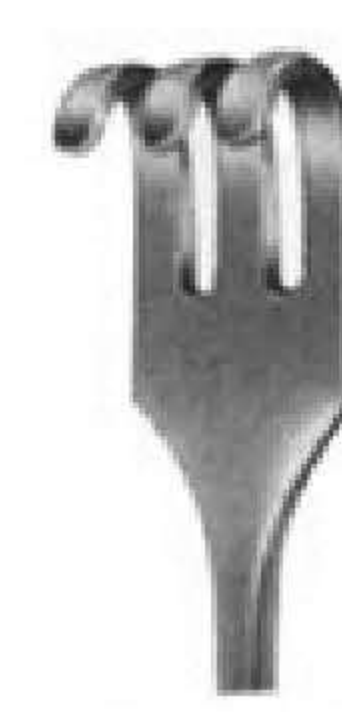

03-5165
8,5 x 13 mm



03-5166
8,5 x 19 mm

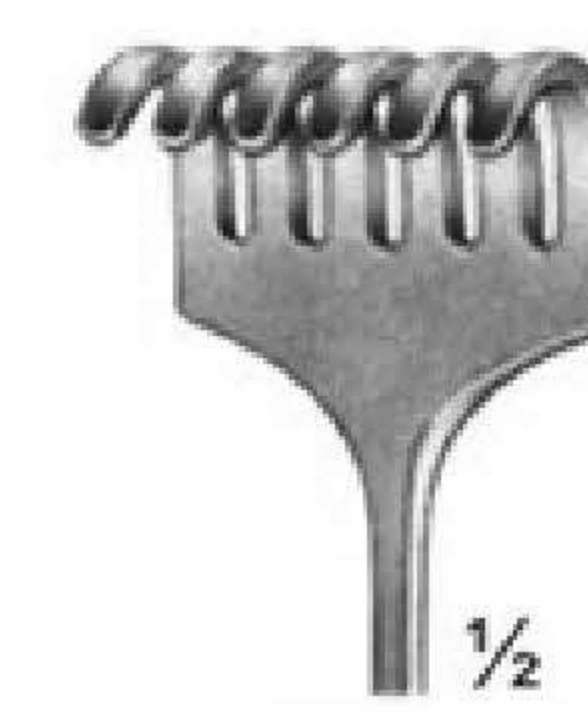

03-5167
8,5 x 29 mm
 $\frac{1}{2}$

Retractors

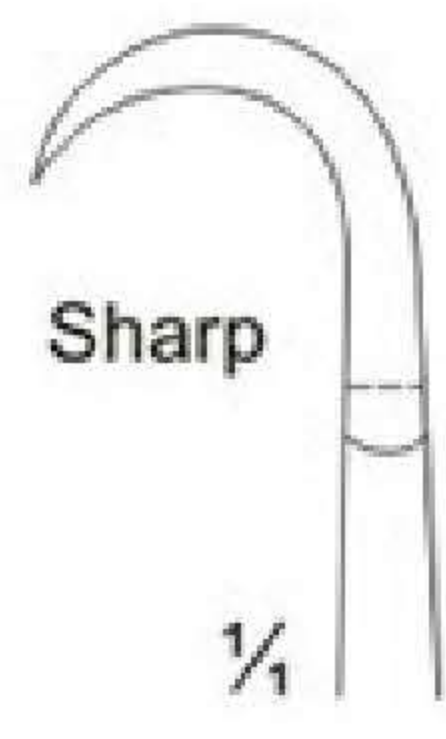

03-5168
9 x 8 mm



03-5169
9 x 13 mm



03-5170
9 x 19 mm



03-5171
9 x 29 mm



03-5172
9 x 40 mm

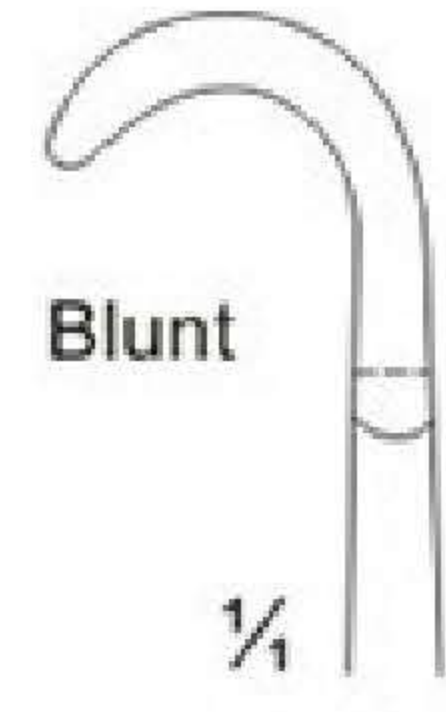

03-5173
8 x 8 mm



03-5174
8 x 13 mm



03-5175
8 x 19 mm



03-5176
8 x 29 mm



03-5177
8 x 40 mm



03-5178
8,5 x 8 mm



03-5179
8,5 x 13 mm



03-5180
8,5 x 19 mm



03-5181
8,5 x 29 mm

03-5168 - 03-5181
VOLKMANN
220 mm

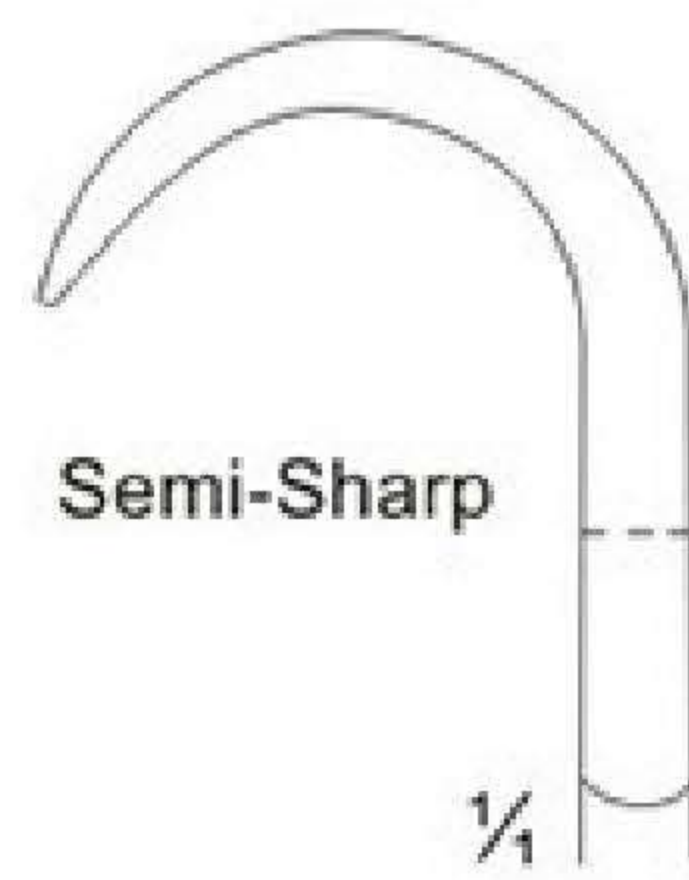

03-5182
16 x 9 mm



03-5183
16 x 14 mm



03-5184
16 x 20 mm



03-5185
16 x 30 mm

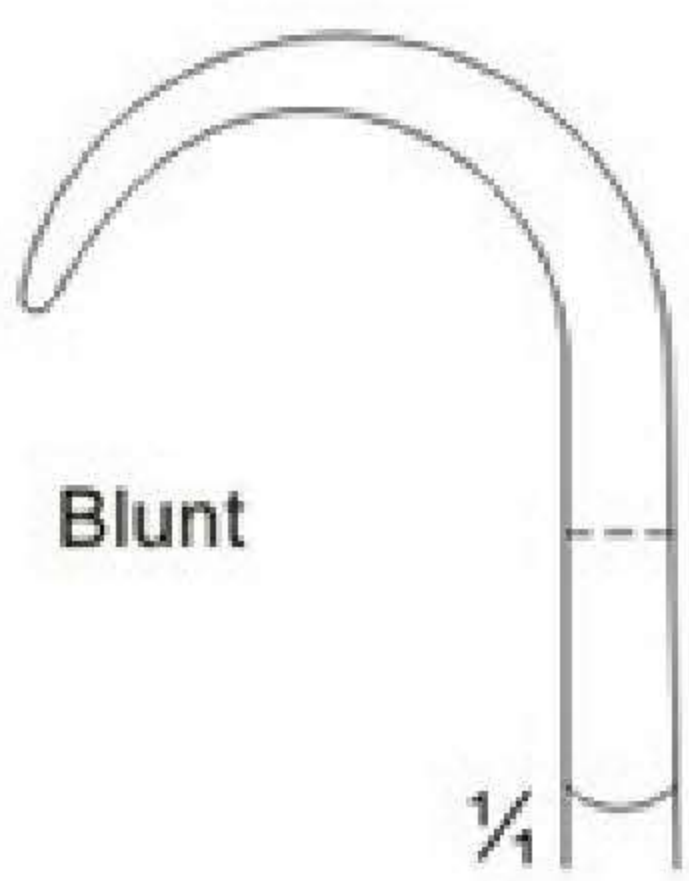

03-5186
15,5 x 9 mm



03-5187
15,5 x 14 mm



03-5188
15,5 x 20 mm



03-5189
15,5 x 30 mm

03-5182 - 03-5189
KOCHER
220 mm

Retractors, Deep form



03-5190 - 03-5191
 KOERTE
 Handle vertical
 to the blade.
 240 mm



03-5190
 8 Prongs, blunt



03-5191
 8 Prongs, sharp



03-5192 - 03-5195
 ISRAEL
 255 mm

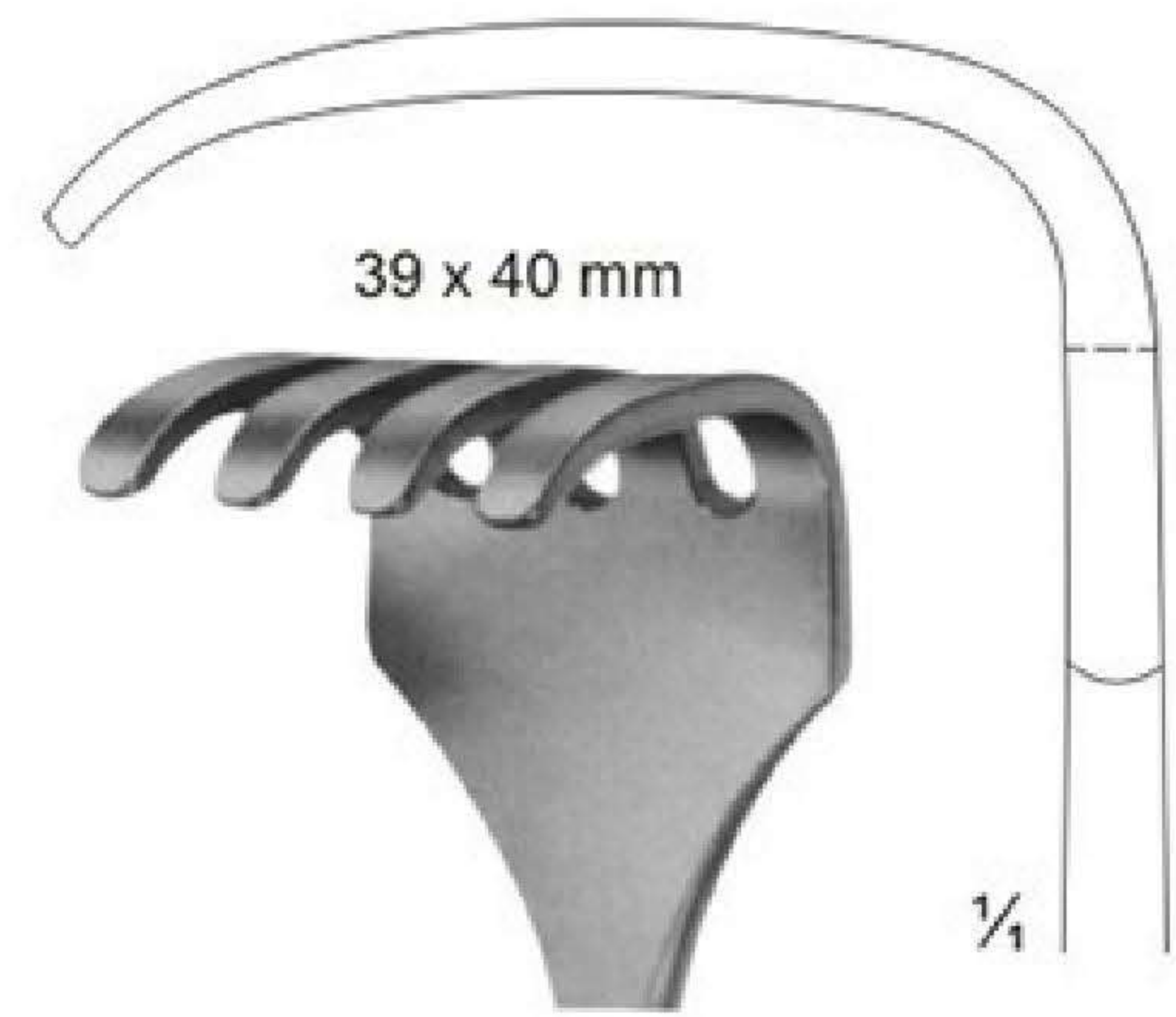

03-5192
 4 Prongs, blunt

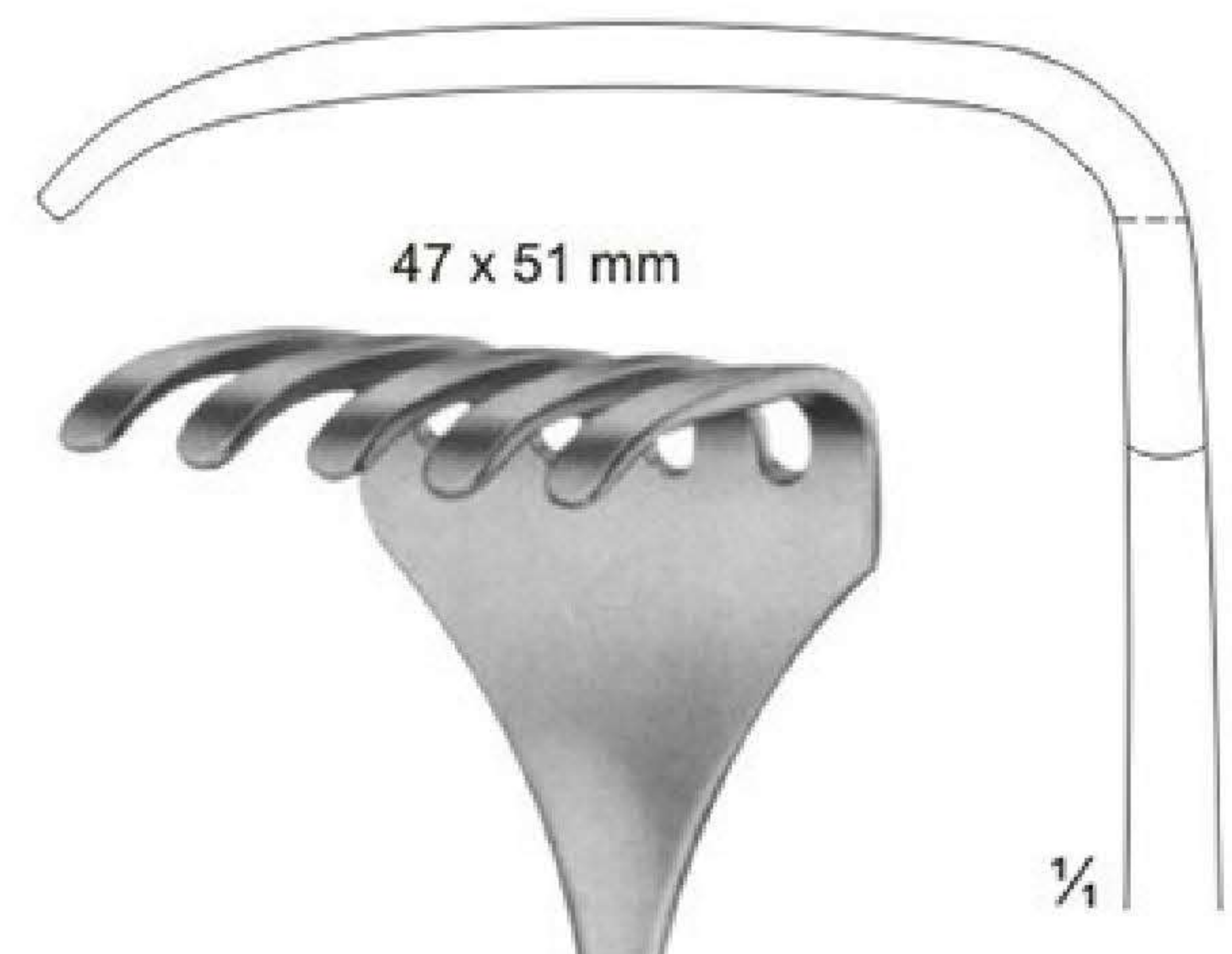

03-5193
 5 Prongs, blunt

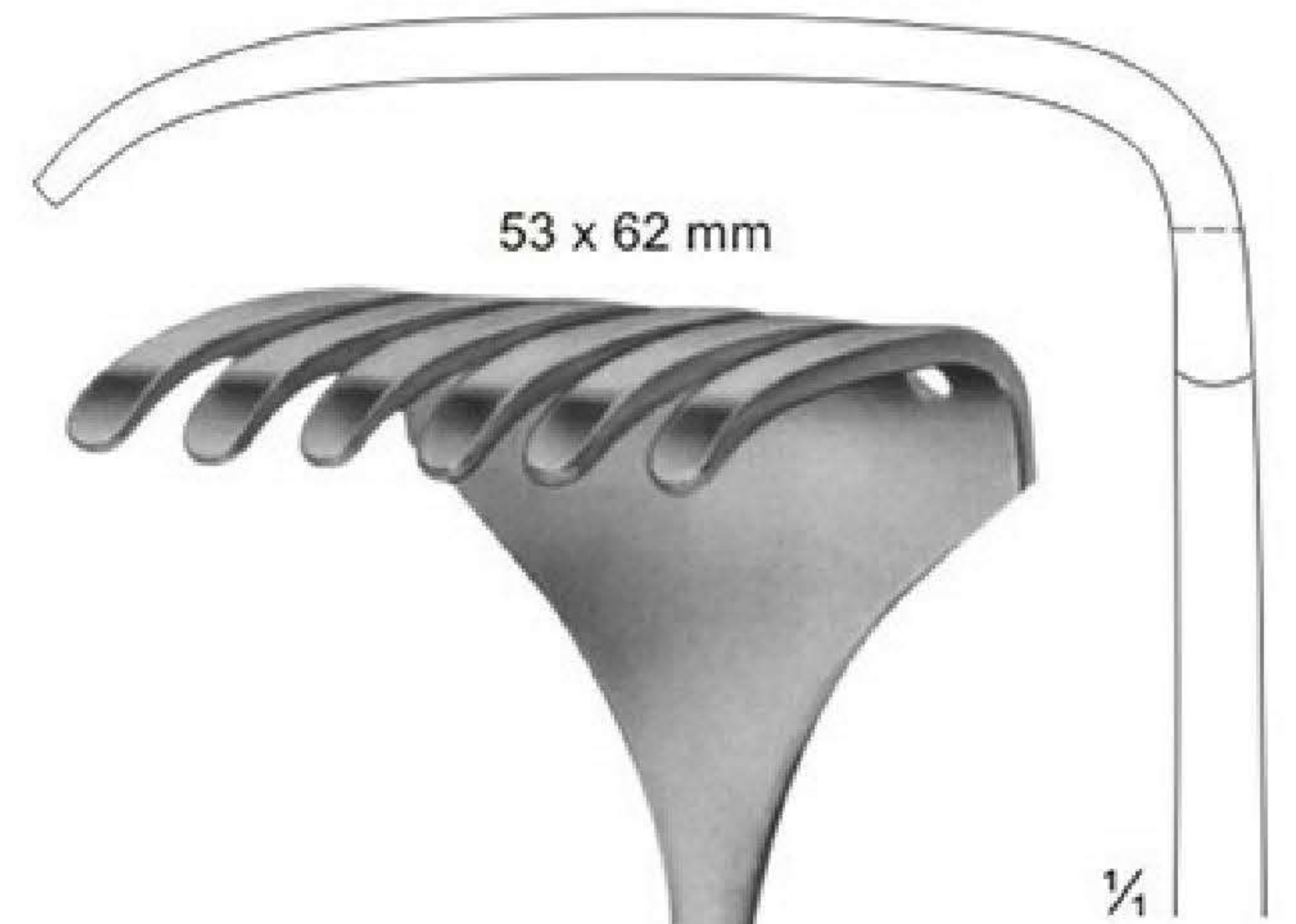

03-5194
 6 Prongs, blunt

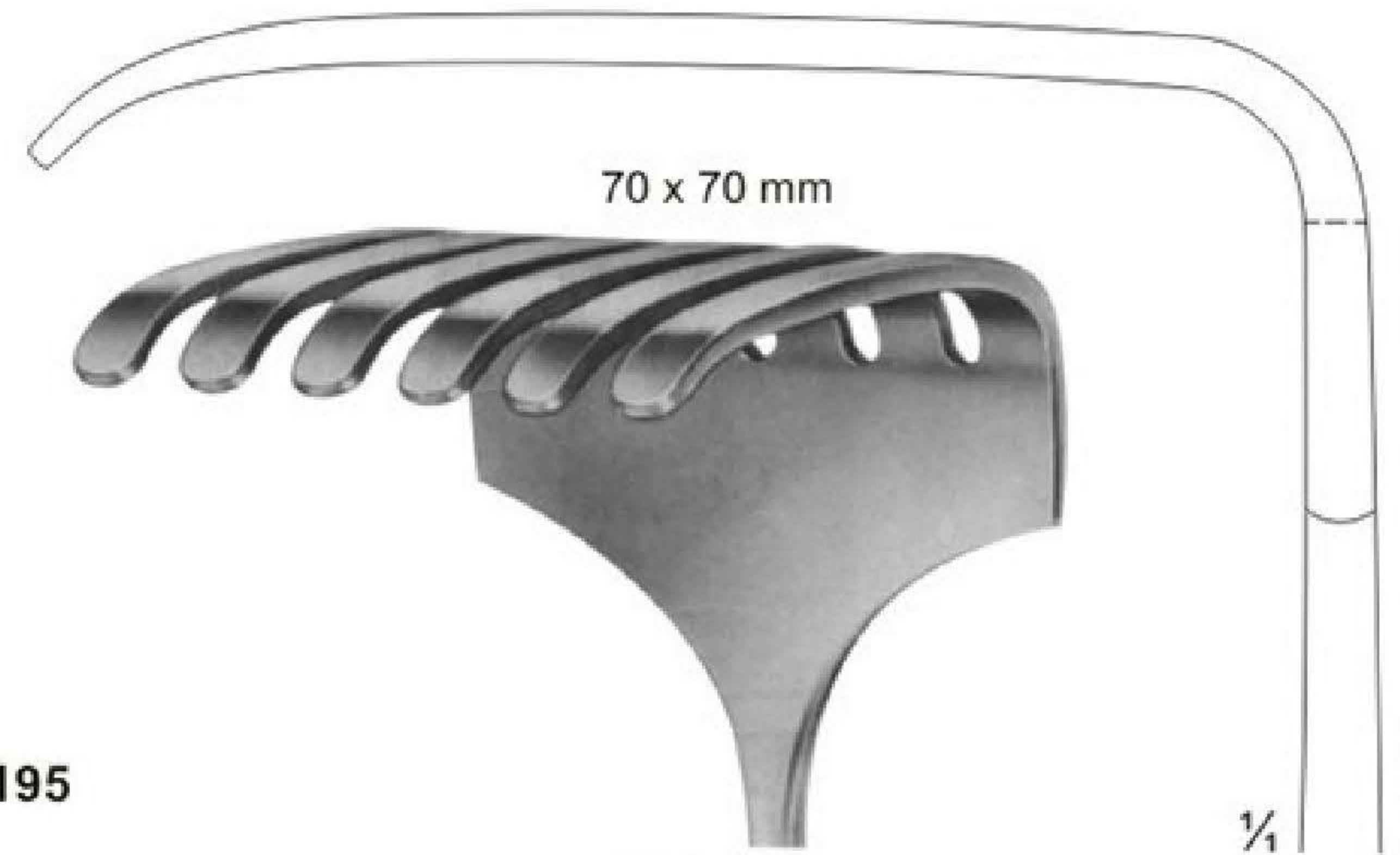

03-5195
 6 Prongs, blunt

Retractors



03-5196 - 03-5201
LANGENBECK
210 mm

- 03-5196** 28 x 10 mm
- 03-5197** 28 x 14 mm
- 03-5198** 33 x 14 mm
- 03-5199** 28 x 16 mm
- 03-5200** 40 x 10 mm
- 03-5201** 40 x 13 mm



03-5202 - 03-5210
KOCHER-LANGENBECK
215 mm

- 03-5202** 25 x 6 mm
- 03-5203** 35 x 8 mm
- 03-5204** 35 x 11 mm
- 03-5205** 35 x 15 mm
- 03-5206** 41 x 11 mm
- 03-5207** 55 x 11 mm
- 03-5208** 70 x 14 mm
- 03-5209** 80 x 12mm
- 03-5210** 80 x 16mm



03-5211
LANGENBECK
215 mm

Retractors



03-5212 - 03-5216
 KOCHER
 230 mm



03-5217 - 03-5219
 SAUERBRUCH
 225 mm

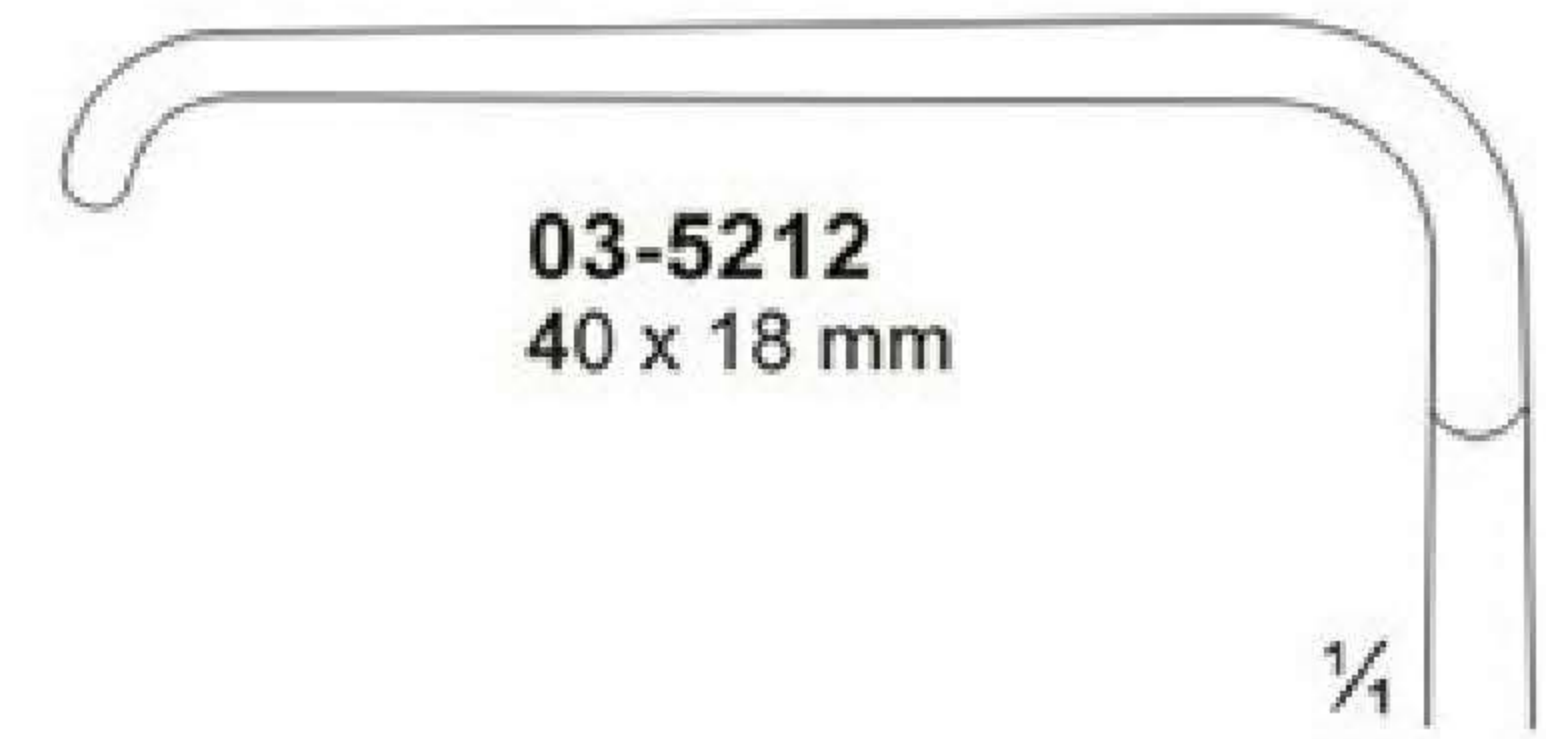

03-5212
 40 x 18 mm

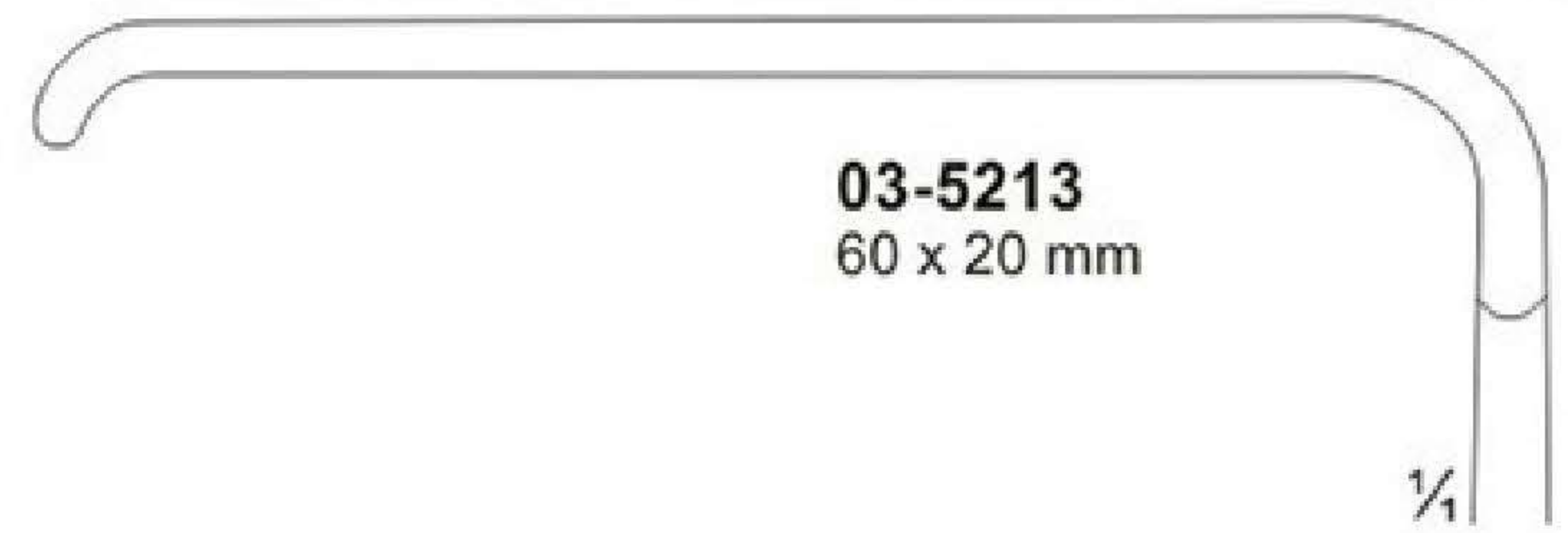

03-5213
 60 x 20 mm

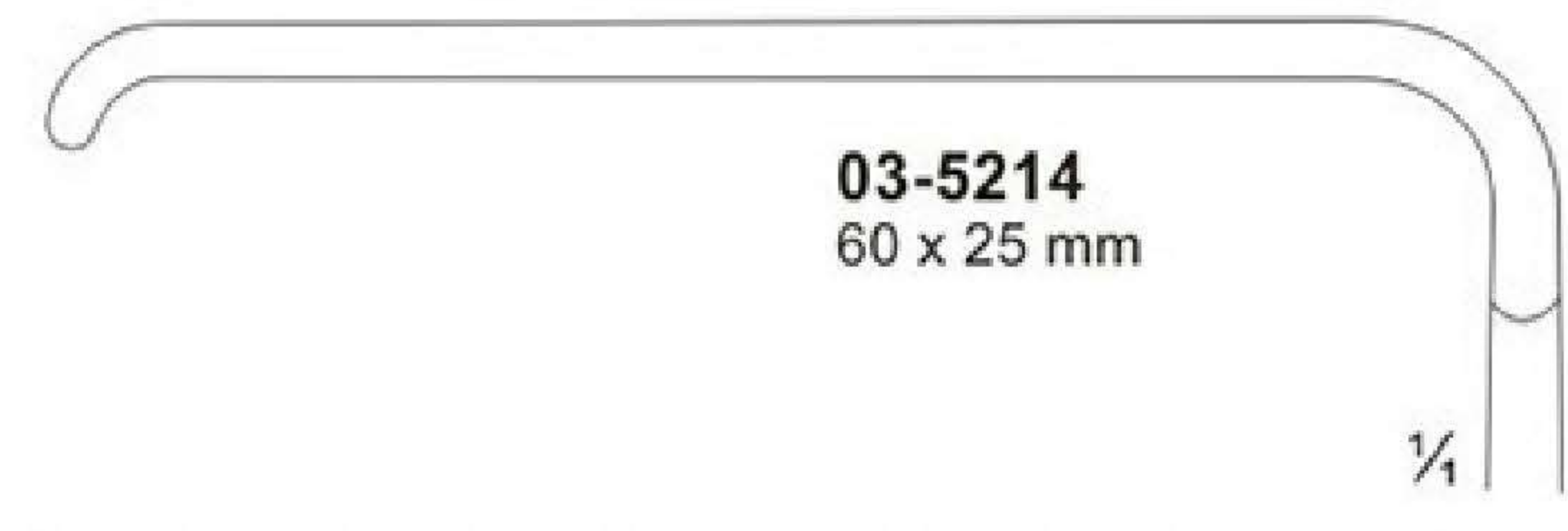

03-5214
 60 x 25 mm

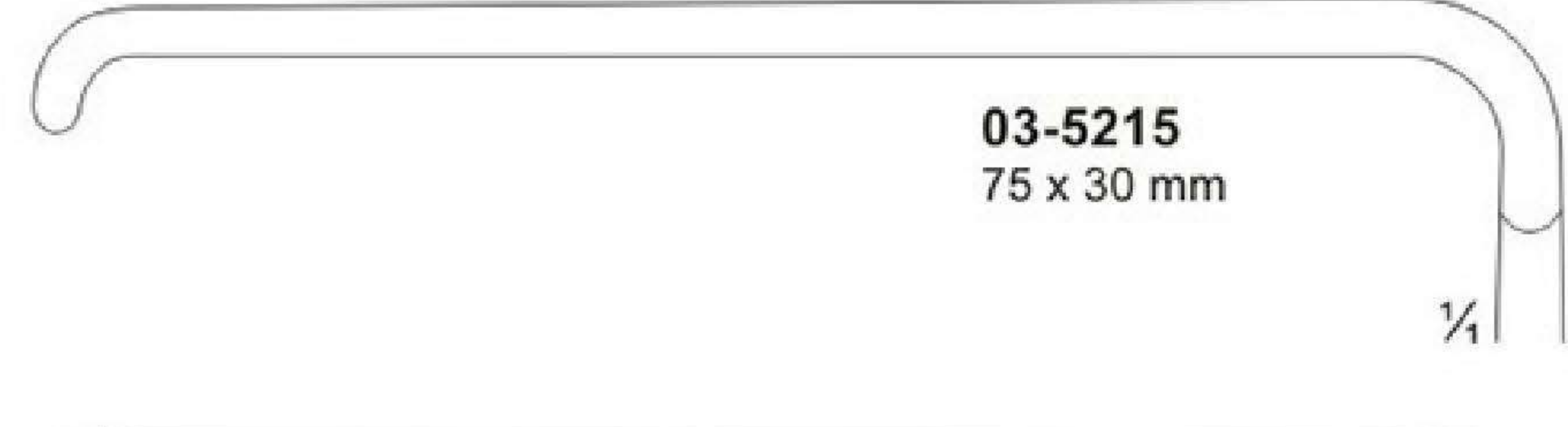

03-5215
 75 x 30 mm

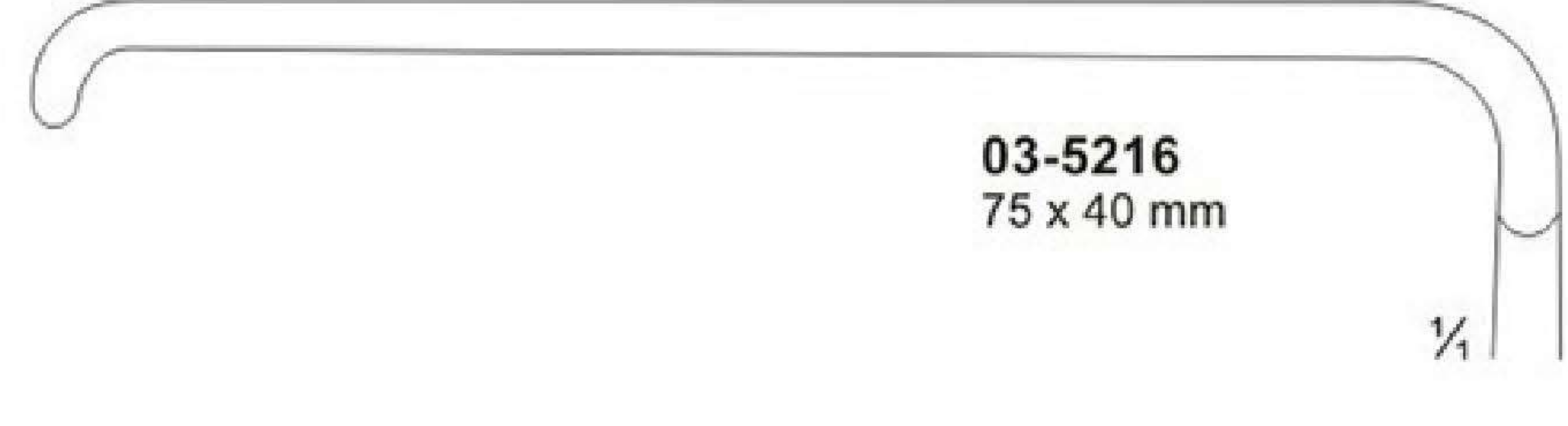

03-5216
 75 x 40 mm

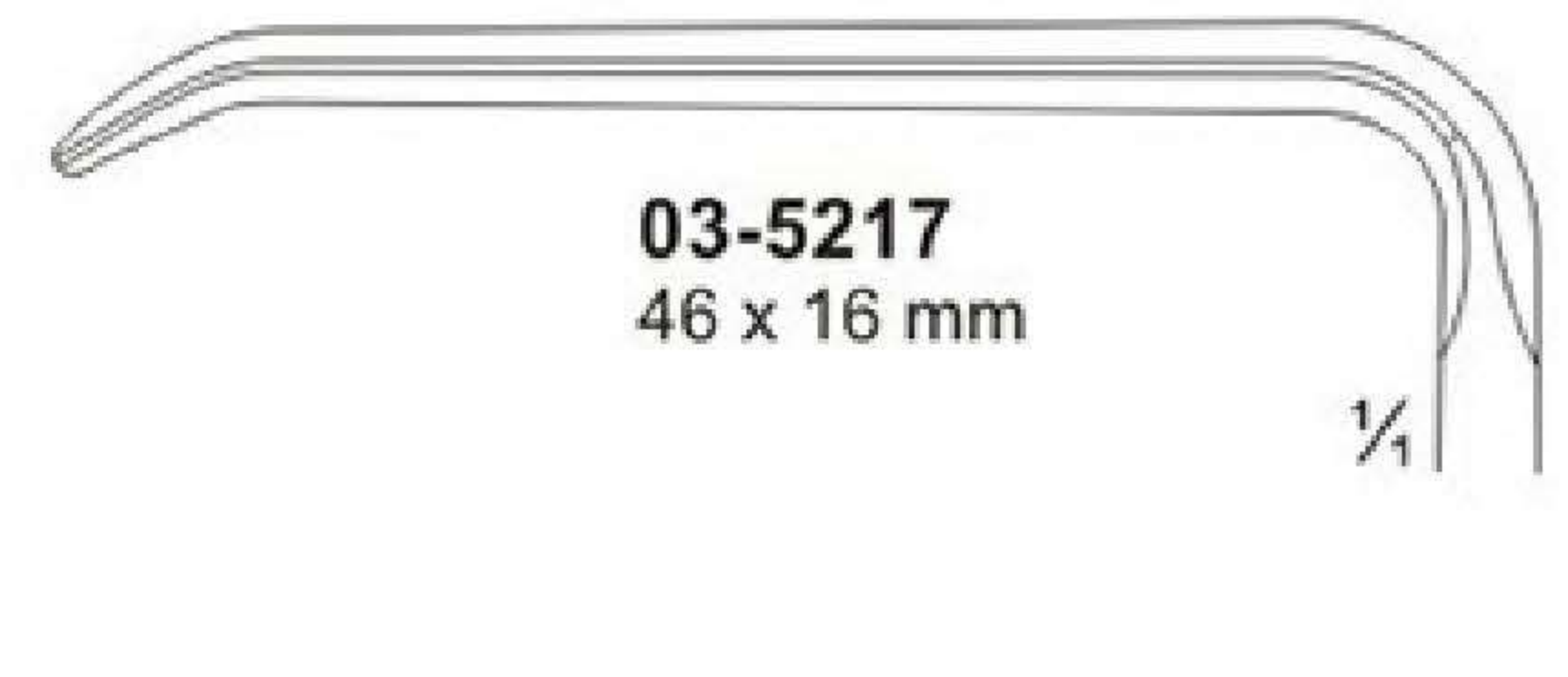

03-5217
 46 x 16 mm

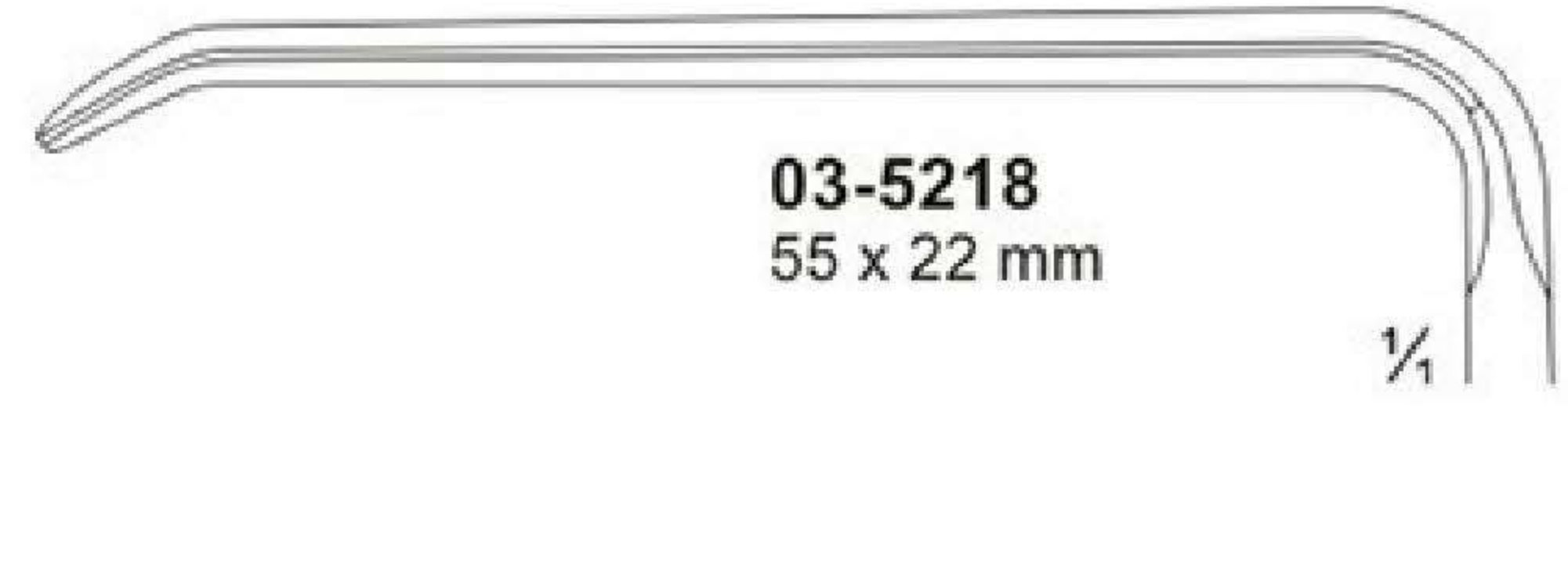

03-5218
 55 x 22 mm



03-5219
 72 x 19 mm

Retractors



03-5220
 15 x 15 mm
 220 mm



03-5221
 20 x 22 mm
 215 mm



03-5222
 28 x 28 mm
 235 mm

03-5220 - 03-5222
 MIDDELDORPF



38 x 18 mm

03-5223
 BUCHS
 205 mm



67 x 17 mm

03-5224
 CASPAR
 210 mm



36 x 20 mm

03-5225
 KOCHER
 230 mm

Retractors



03-5226 - 03-5231
HOSEL
250 mm

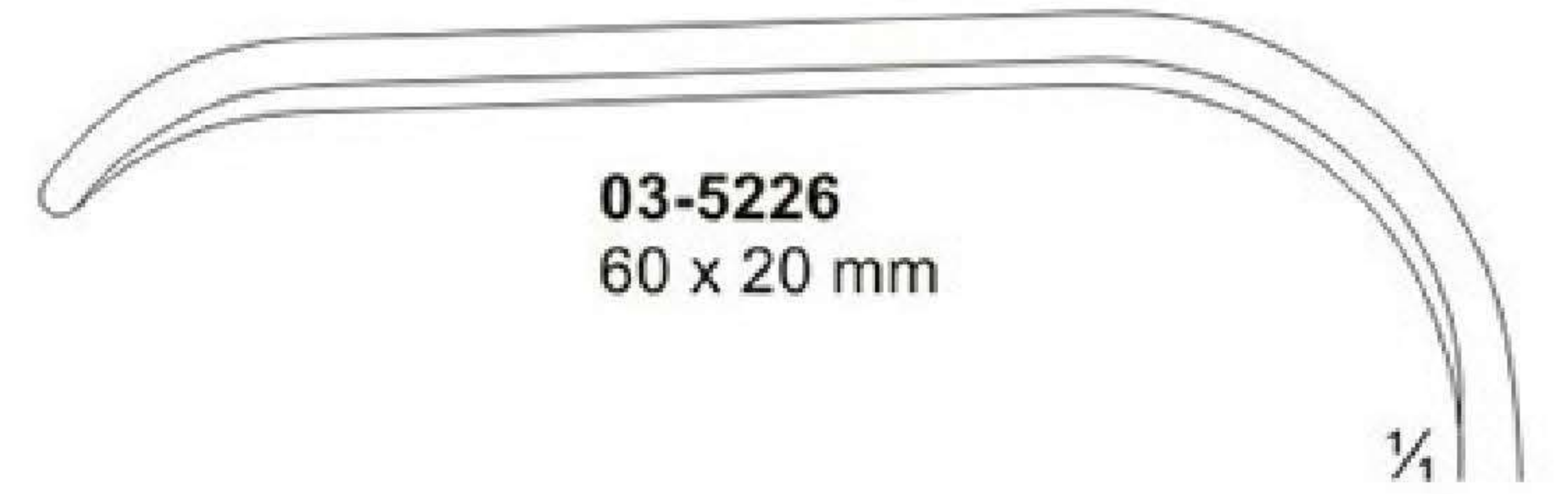

03-5226
60 x 20 mm

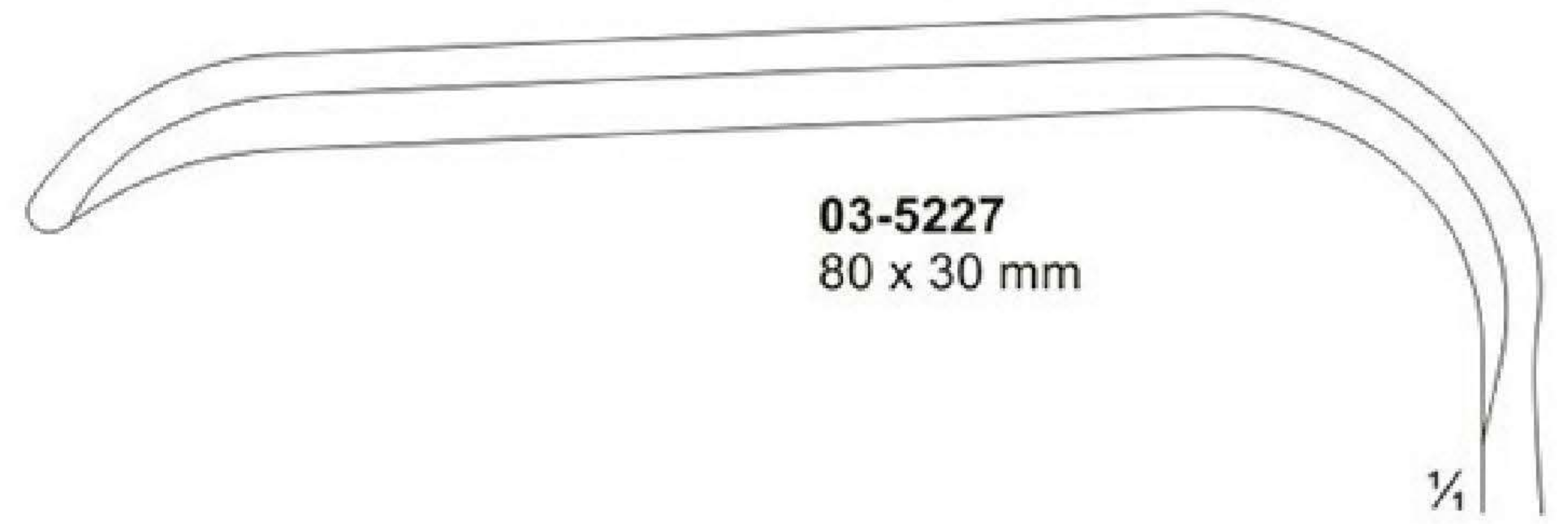

03-5227
80 x 30 mm

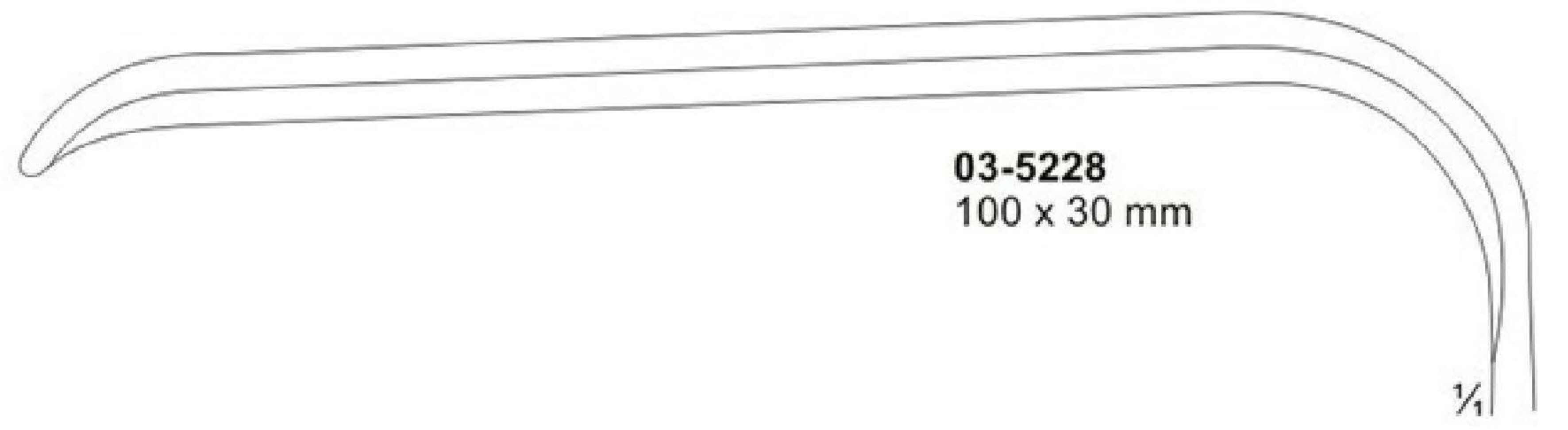

03-5228
100 x 30 mm

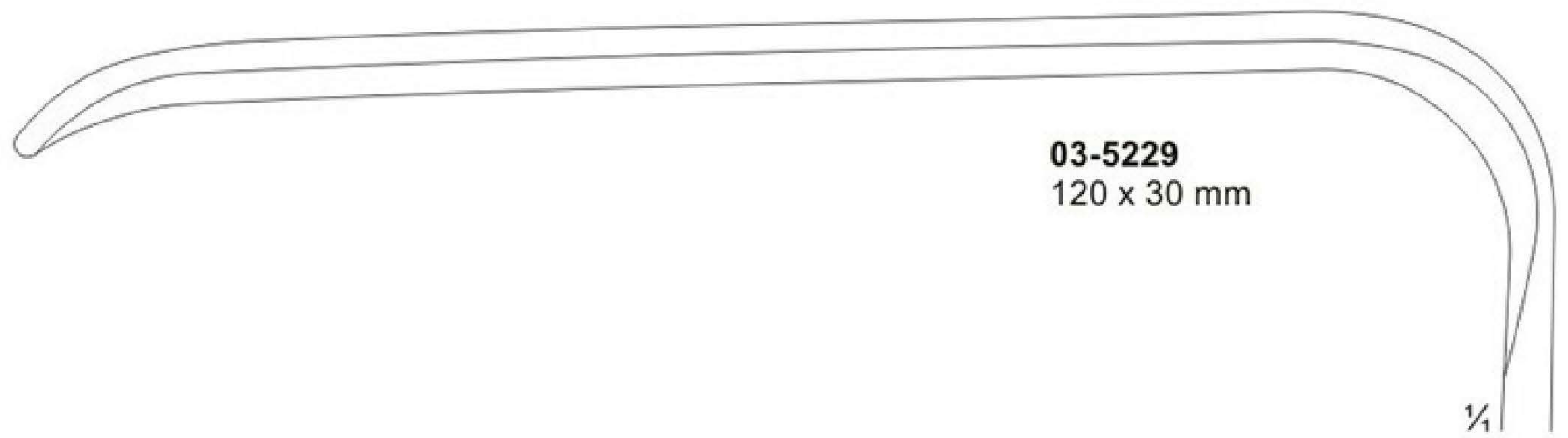

03-5229
120 x 30 mm

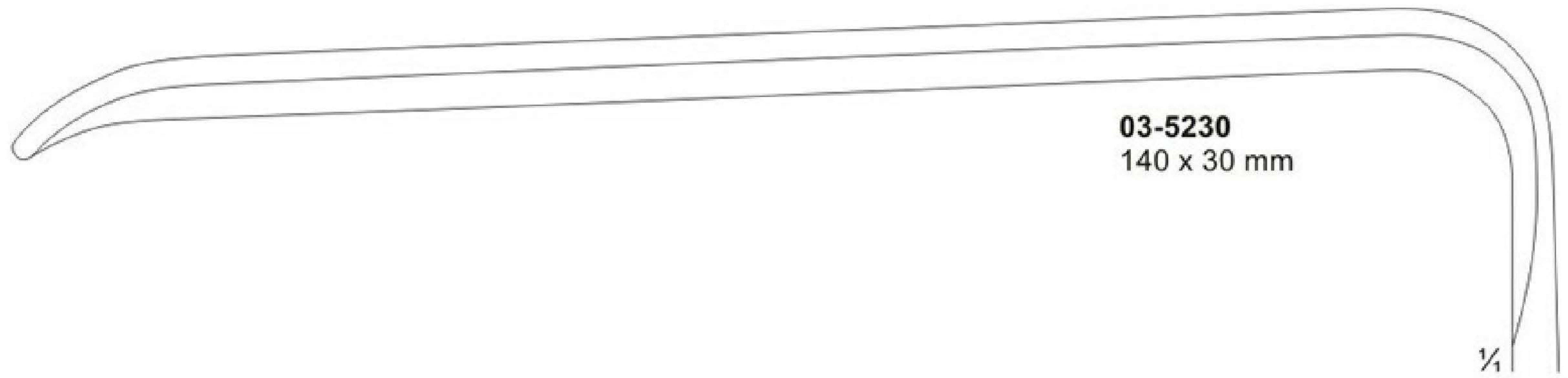

03-5230
140 x 30 mm

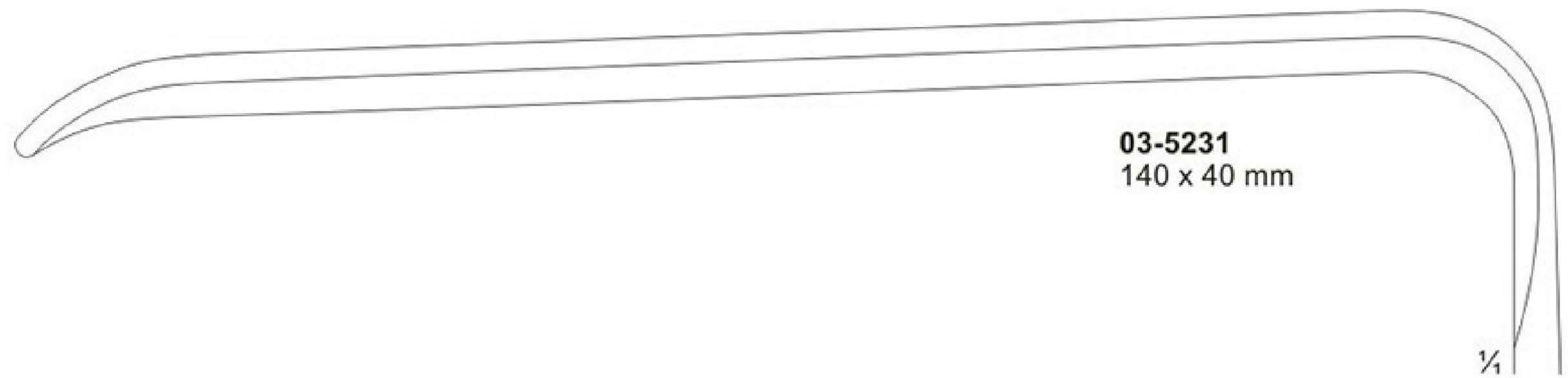

03-5231
140 x 40 mm

Retractors

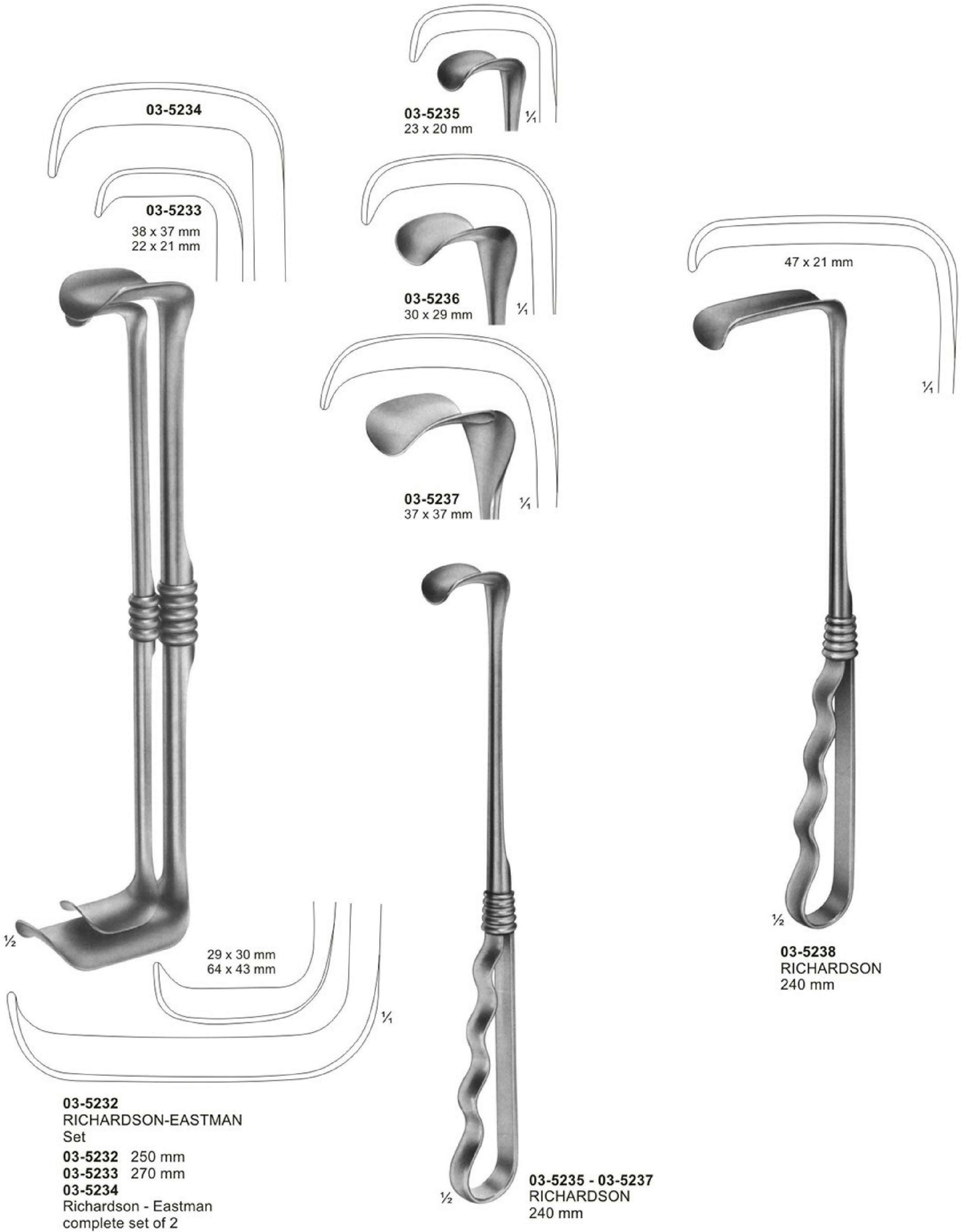

Retractors

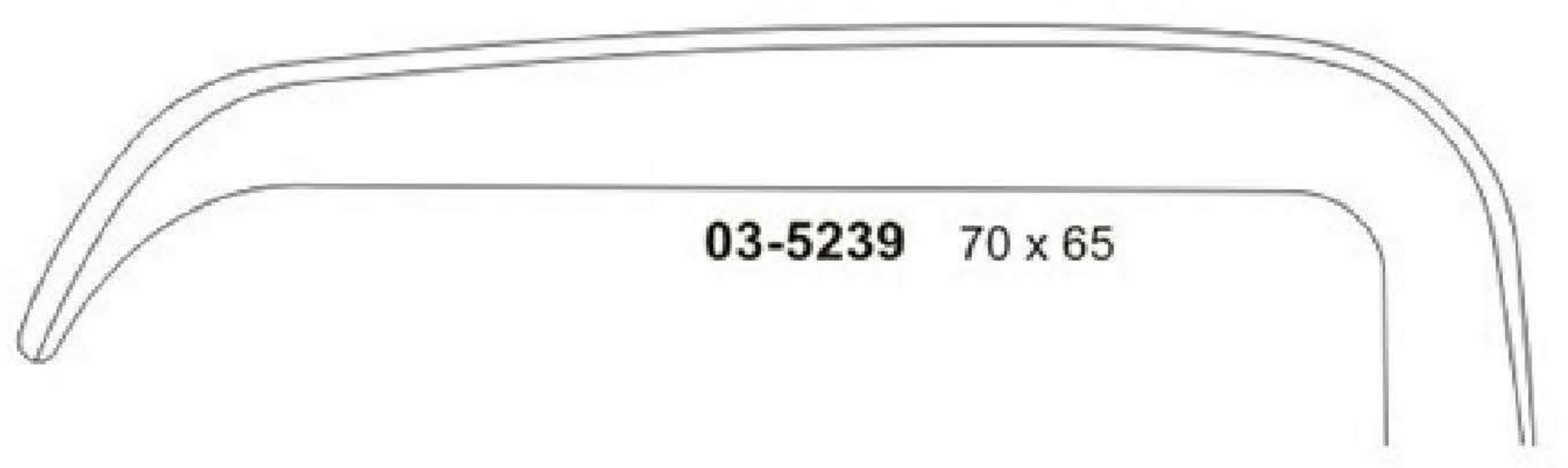

1/2
03-5239 - 03-5240
KELLY
260 mm

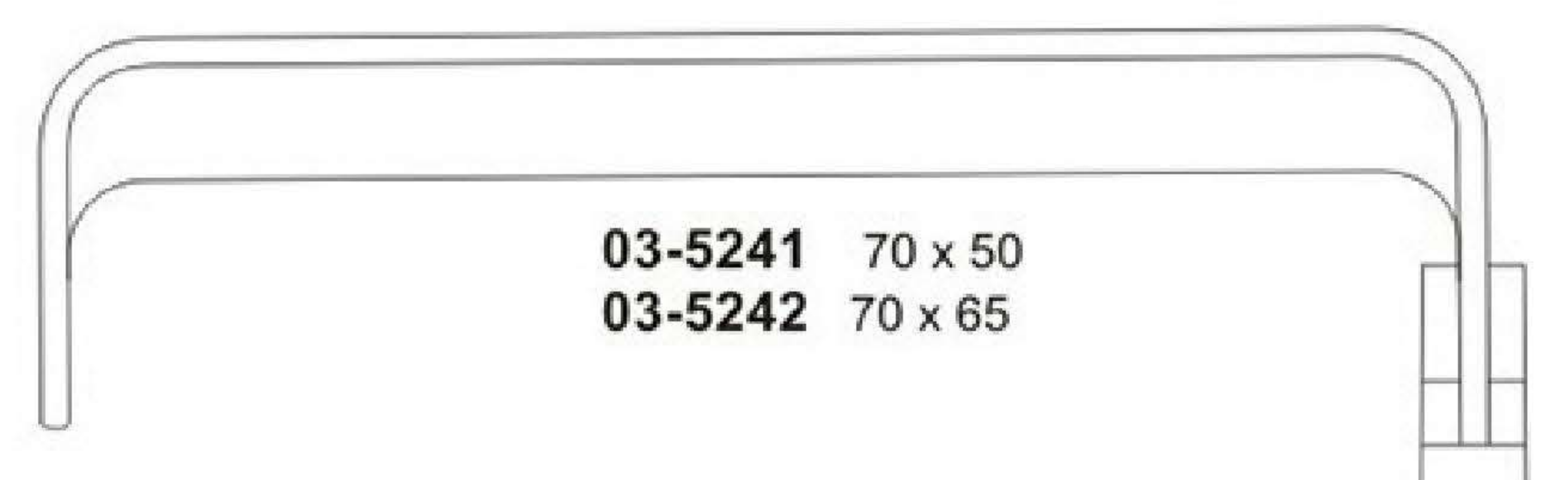

1/2
03-5241 - 03-5242
MORRIS
245 mm

Retractors For Deep Surgery



Retractors For Deep Surgery

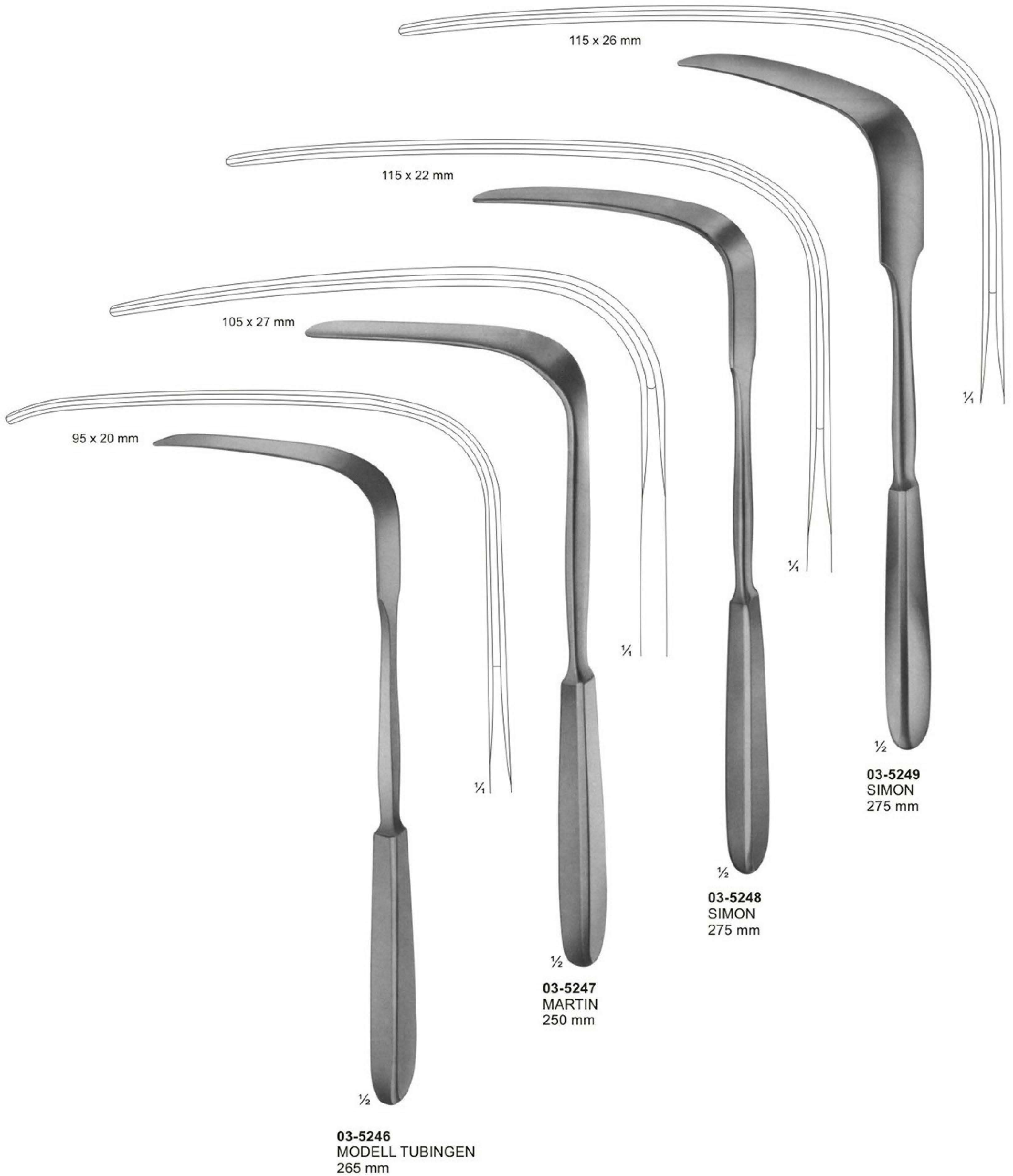

Retractors, Vario Retractor System, Germ. Fed.
 Patent, Germ. Fed. Regd.Des, US-Patent.

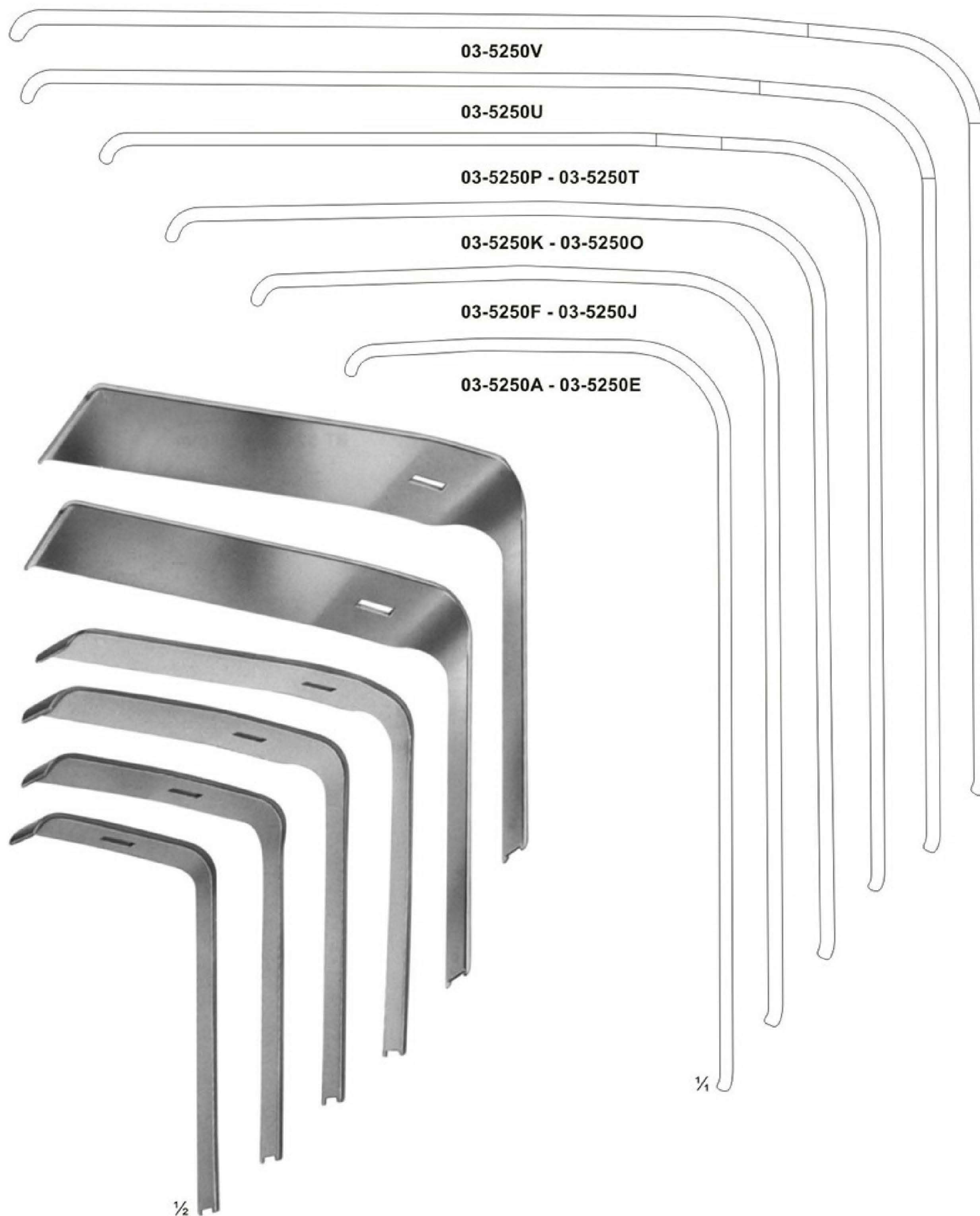

Retractor blades for handles 03-5250

| Depth | Width | | | | | | |
|-------|----------|----------|----------|----------|----------|----------|----------|
| | 14mm | 18mm | 22mm | 26mm | 30mm | 40mm | 50mm |
| 55mm | 03-5250A | 03-5250B | 03-5250C | 03-5250D | 03-5250E | - | - |
| 75mm | 03-5250F | 03-5250G | 03-5250H | 03-5250I | 03-5250J | - | - |
| 95mm | 03-5250K | 03-5250L | 03-5250M | 03-5250N | 03-5250O | - | - |
| 115mm | 03-5250P | 03-5250Q | 03-5250R | 03-5250S | 03-5250T | - | - |
| 135mm | - | - | - | - | - | 03-5250U | - |
| 145mm | - | - | - | - | - | - | 03-5250V |

Retractors, Vario Retractor System, Germ. Fed. Patent, Germ. Fed. Regd.Des, US-Patent.

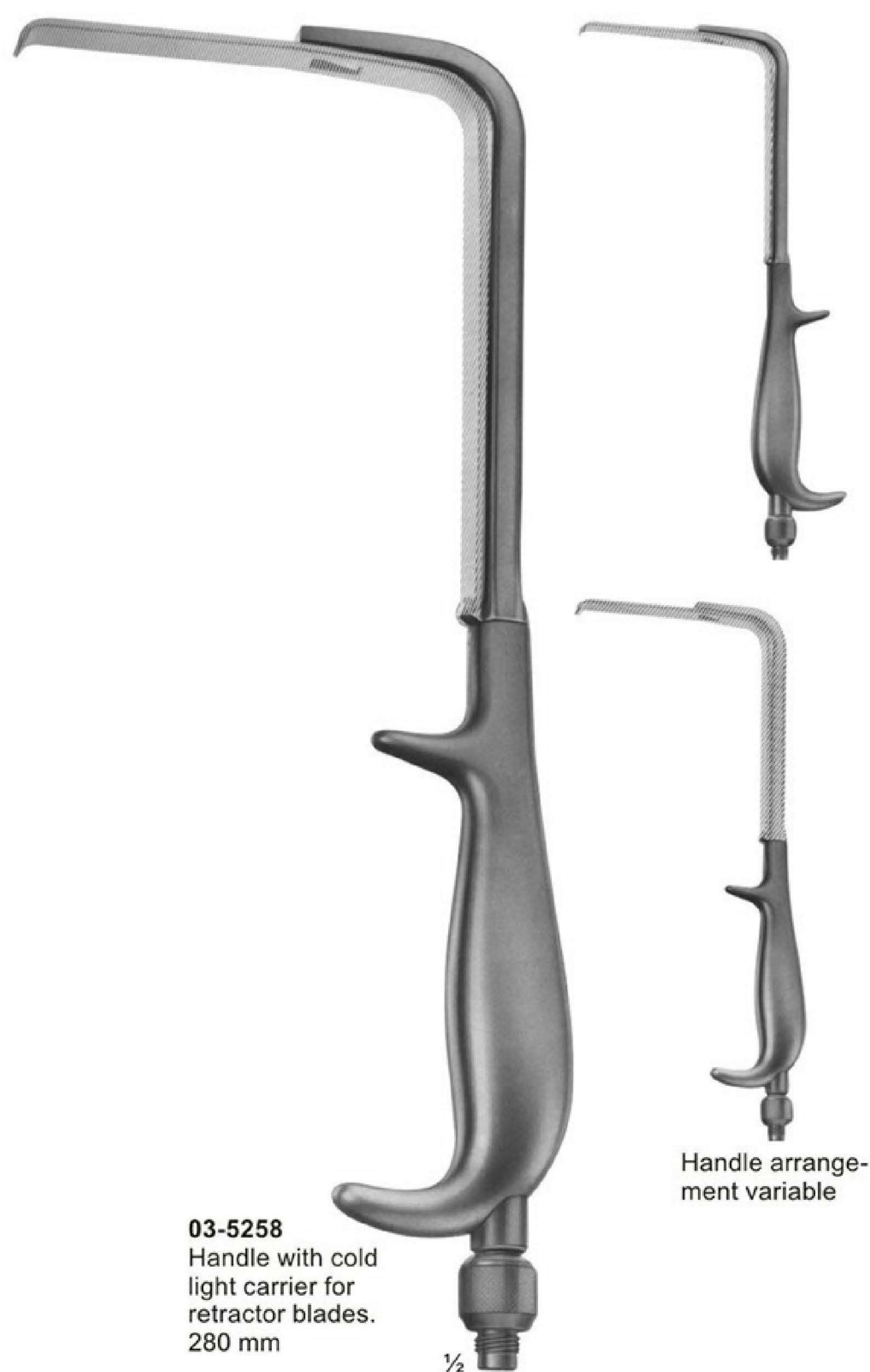
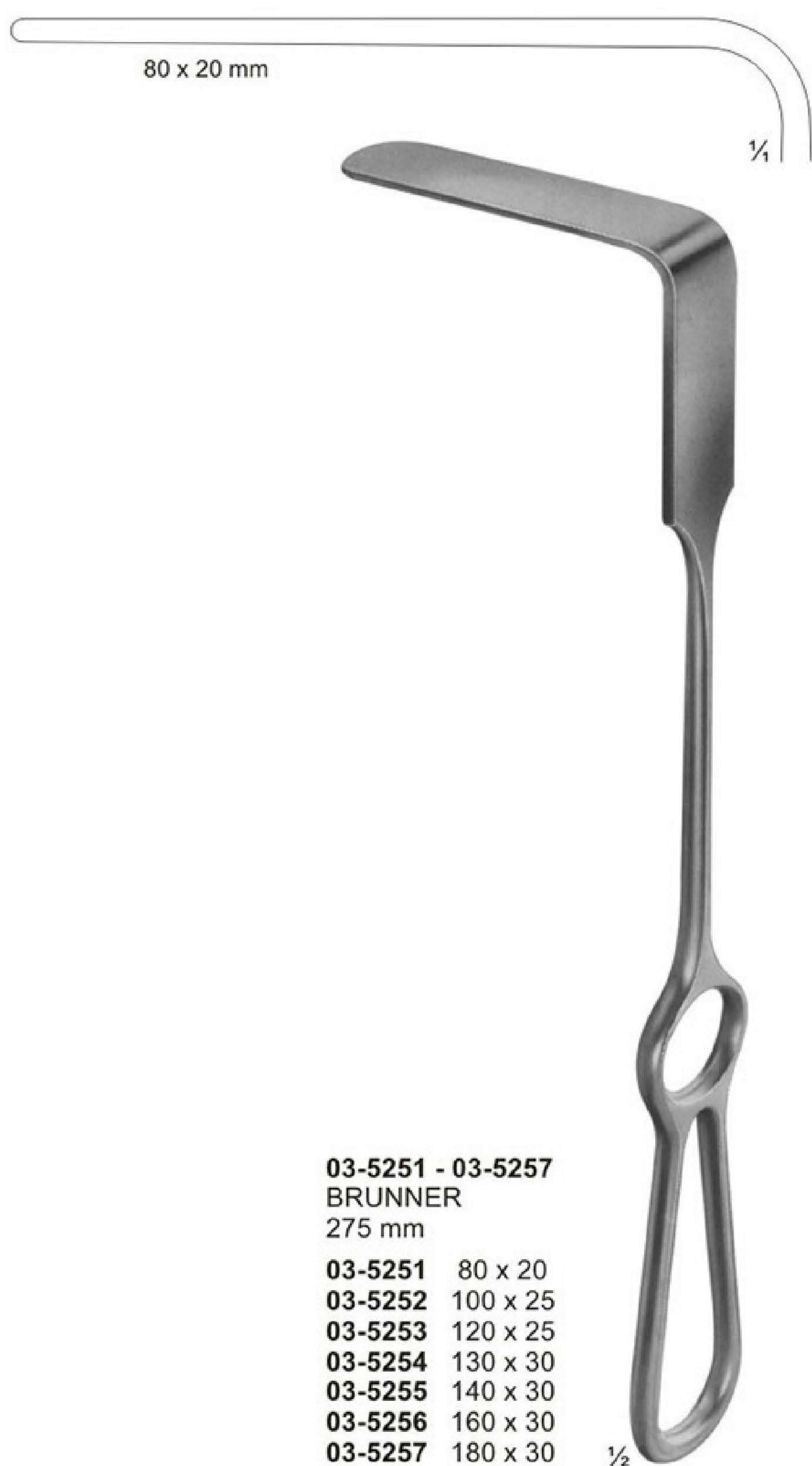

Retractors, Lung Spatulas

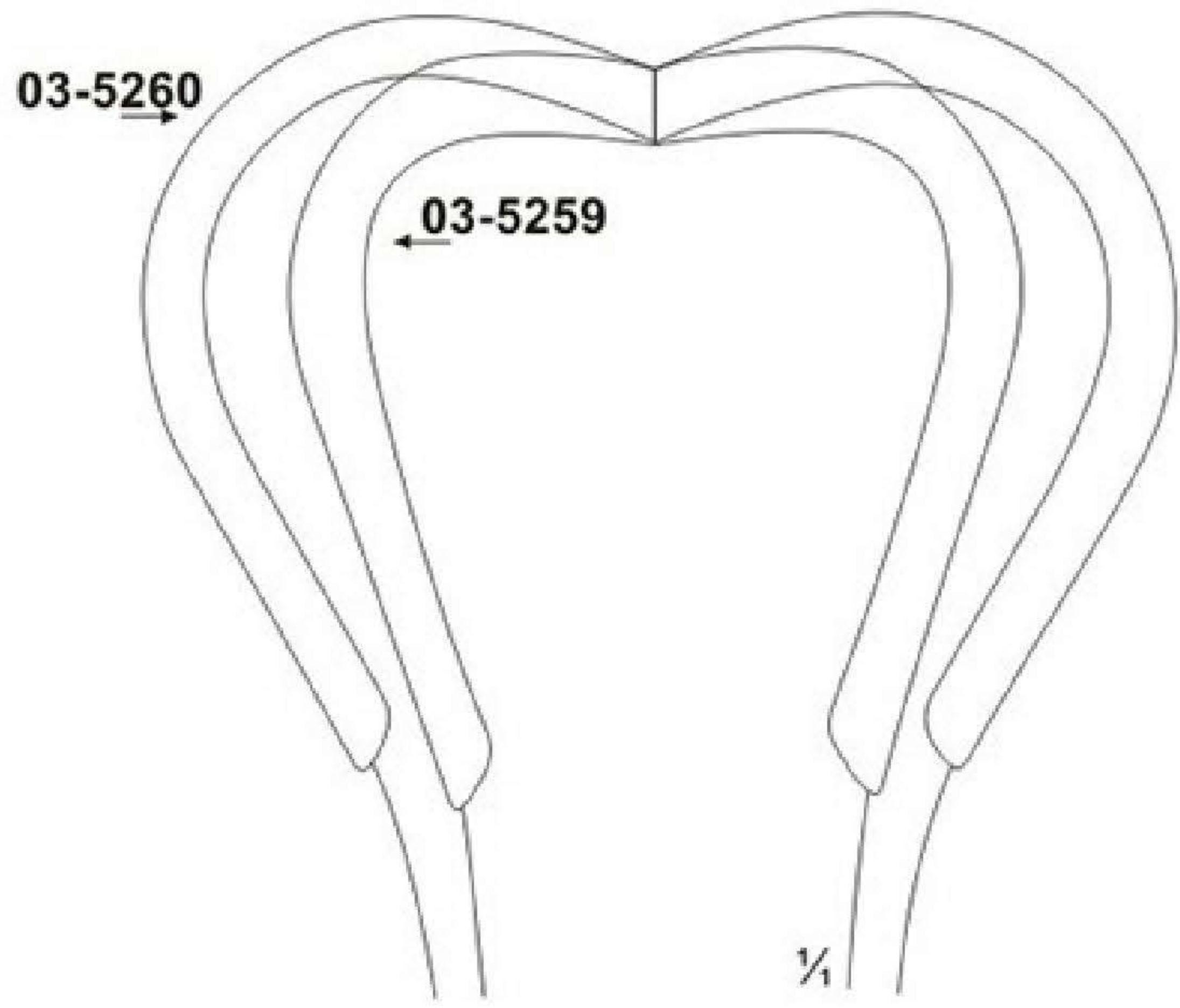

03-5259 - 03-5260
 HARRINGTON
 03-5259 123 x 45 mm
 03-5260 123 x 64 mm
 Flexible
 295 mm



03-5261
 ALLISON
 255 mm

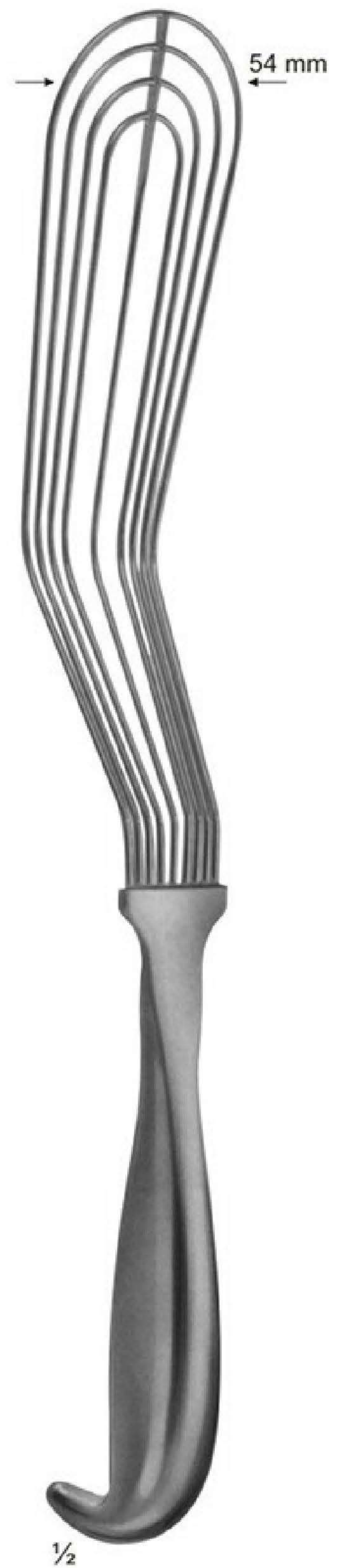

03-5262
 ALLISON
 320 mm

Retractors, Lung Spatulas



Retractors, Lung Spatulas



Retractors, Lung Spatulas



03-5274
DEAVER
300 mm
Fig. 3

03-5275
DEAVER
310 mm
Fig. 4

03-5276
DEAVER
320 mm
Fig. 5

Retractors, Lung Spatulas

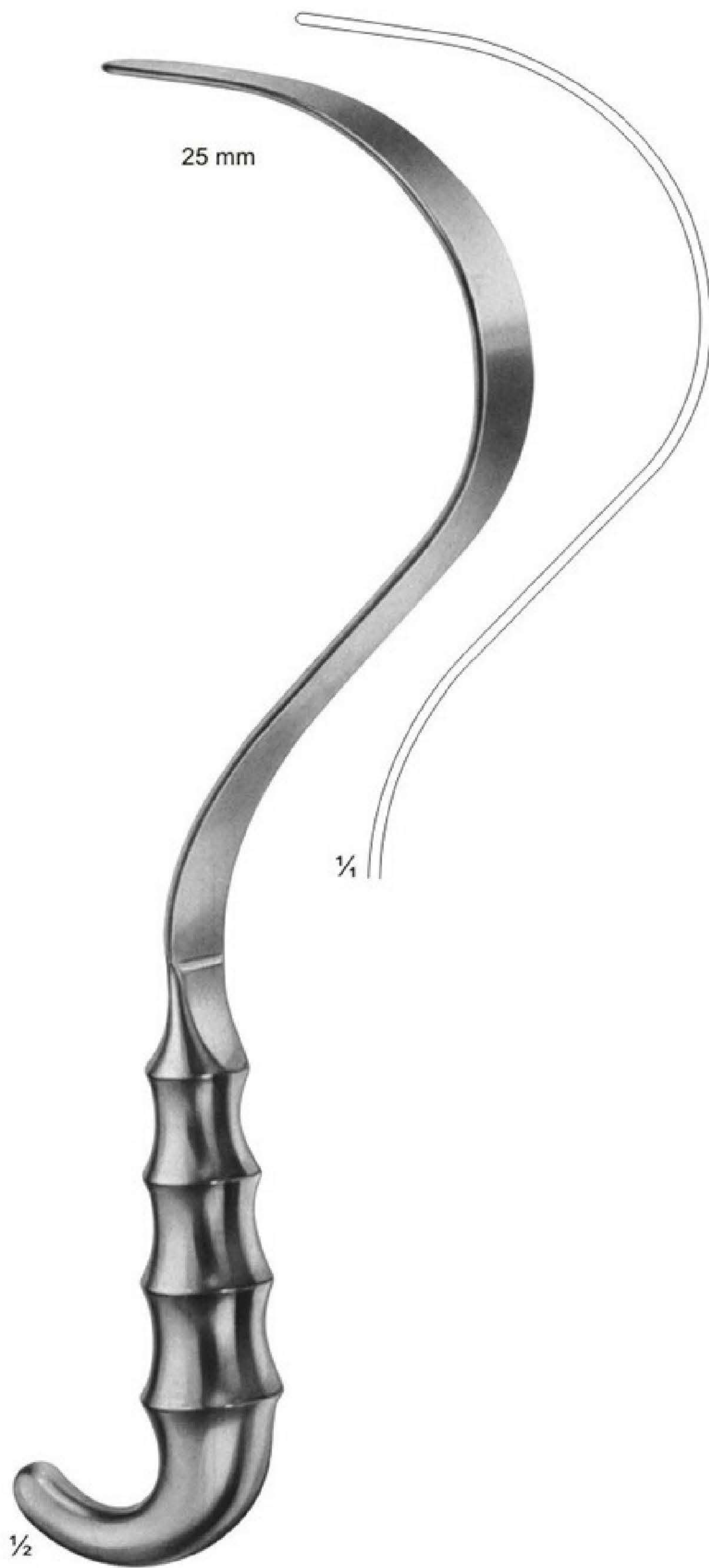

03-5277
DEAVER
310 mm
Fig. 1

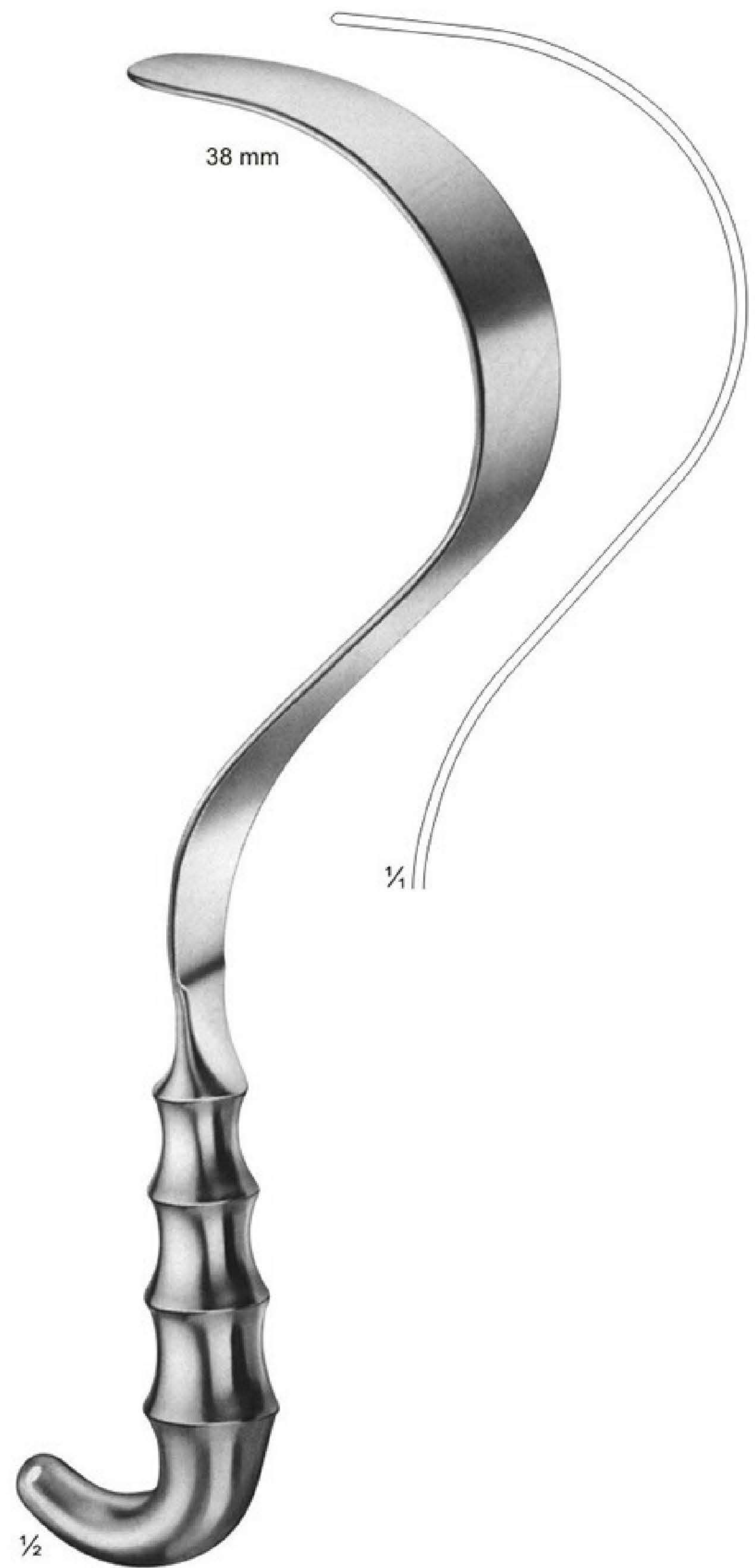

03-5278
DEAVER
310 mm
Fig. 3

Retractors, Lung Spatulas

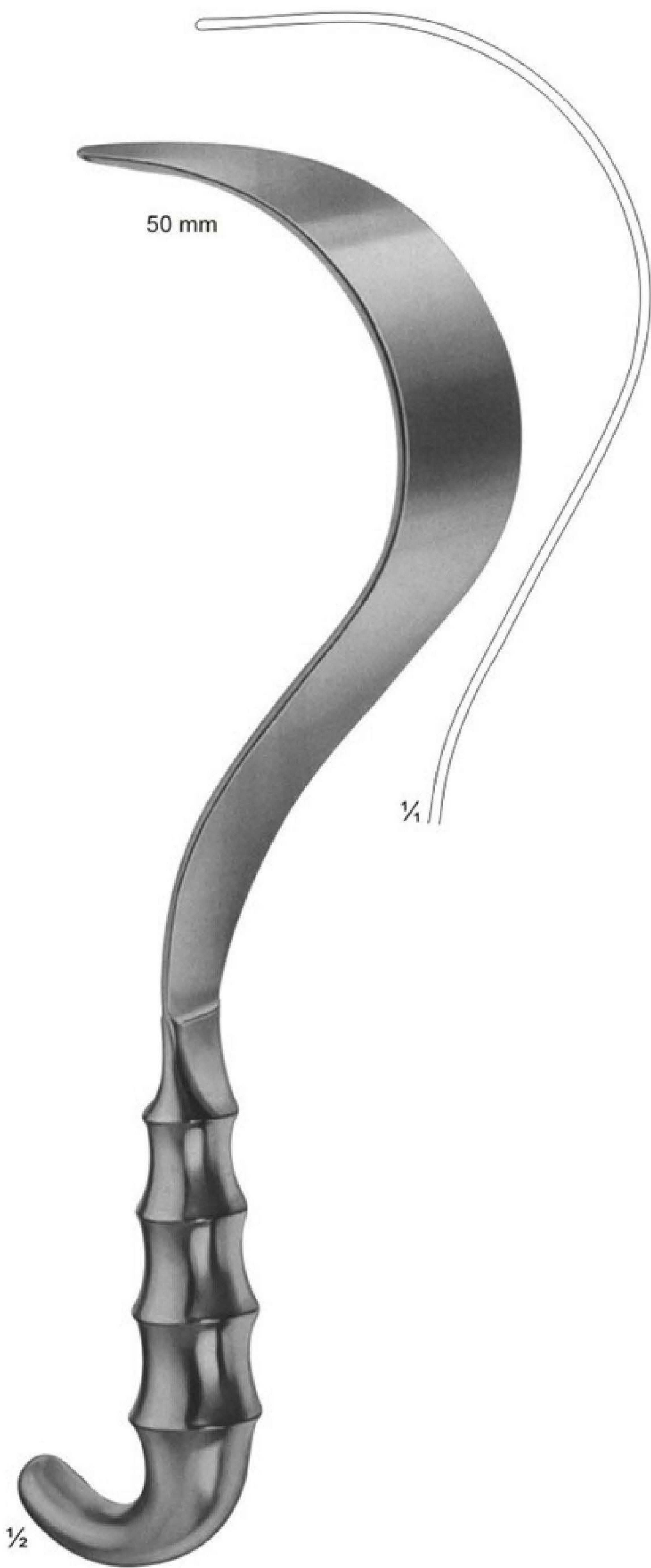

03-5279
DEAVER
305 mm
Fig. 4



03-5280
DEAVER
310 mm
Fig. 5

Retractors For Deep Surgery (Abdominal Retractors)

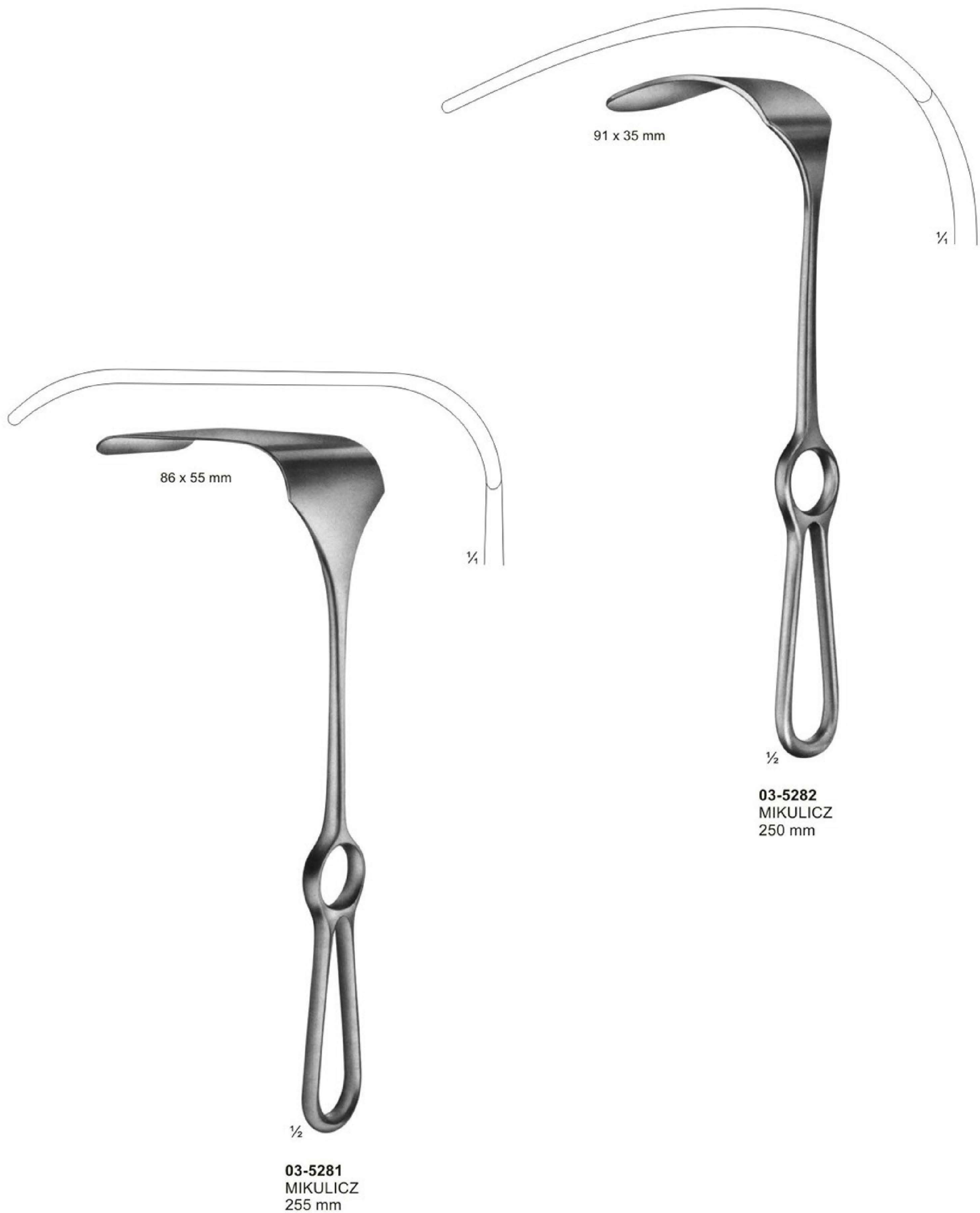

Retractors For Deep Surgery (Abdominal Retractors)

03-5285 150 x 39 mm
 03-5286 150 x 57 mm

03-5283 121 x 50 mm
 03-5284 147 x 50 mm

03-5285 - 03-5286
 KELLY
 03-5285 150 x 39 mm
 03-5286 150 x 57 mm
 260 mm

03-5283 - 03-5284
 MIKULICZ
 03-5283 121 x 50 mm
 03-5284 147 x 50 mm
 Liver Retractor
 250 mm

Retractors, Abdominal Retractors



03-5298 Fig.1 32 x 40 mm
03-5299 Fig.2 34 x 50 mm
03-5300 Fig.3 41 x 60 mm
03-5301 Fig.4 46 x 75 mm
03-5302 Fig.5 64 x 85 mm

| Length of Blades | Width of Blades | | |
|------------------|-----------------|---------|---------|
| | 35mm | 45mm | 60mm |
| 62mm | 03-5287 | 03-5290 | 03-5294 |
| 92mm | 03-5288 | 03-5291 | 03-5295 |
| 122mm | 03-5289 | 03-5292 | 03-5296 |
| 160mm | | 03-5293 | 03-5297 |

Abdominal Retractors



03-5304 - 03-5308
ROCHARD
310 mm
03-5304 48 x 90 mm
03-5305 48 x 105 mm
03-5306 48 x 120 mm
03-5307 48 x 135 mm
03-5308 48 x 155 mm



03-5309
ROCHARD
Fixation device for



03-5310 - 03-5313
DOYEN
280 mm
03-5310 48 x 90 mm
03-5311 48 x 105 mm
03-5312 48 x 120 mm
03-5313 48 x 135 mm



03-5314
DOYEN-CHILD
Fixation device
220 mm



03-5315
Chain
with weight
645g
790 mm

Pelvis Retractors

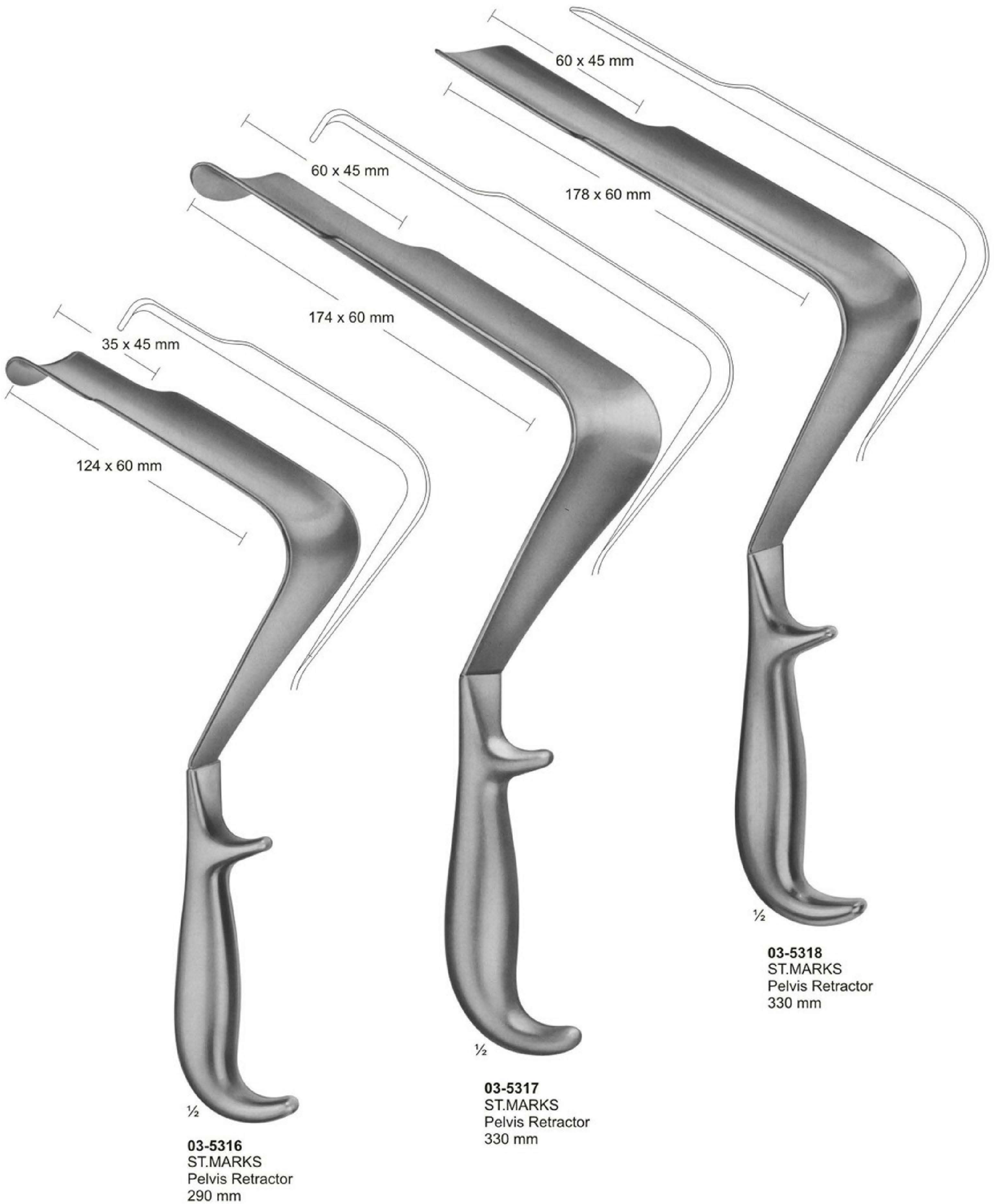

Abdominal- and Intestinal Spatulas

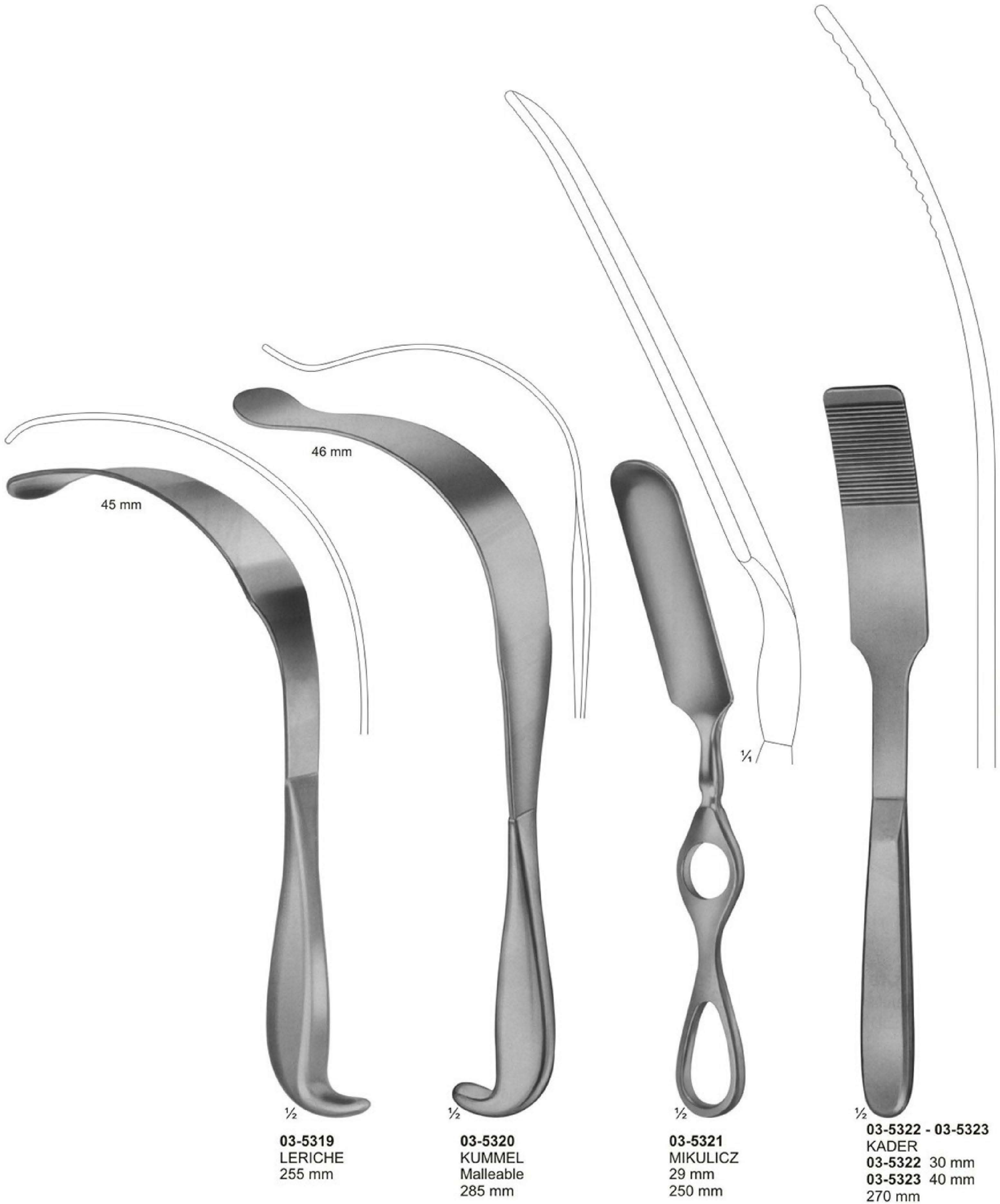

1/2
03-5319
 LERICHE
 255 mm

1/2
03-5320
 KUMMEL
 Malleable
 285 mm

1/2
03-5321
 MIKULICZ
 29 mm
 250 mm

1/2
03-5322 - 03-5323
 KADER
03-5322 30 mm
03-5323 40 mm
 270 mm

Abdominal- and Intestinal Spatulas



03-5324
 REVERDIN
 285 mm



03-5325
 HABERER
 Malleable
 305 mm



03-5326 - 03-5328
 03-5326 30 mm
 03-5327 40 mm
 03-5328 50 mm
 Malleable
 330 mm



03-5329
 TUFFIER
 Malleable
 200 mm

Self-Retaining Retractors



03-5330
BOSE
60 mm



03-5331
FINSEN
50 mm



03-5332
FINSEN
70 mm



03-5333
FINSEN modif.
75 mm



03-5334
45 mm



03-5335
55 mm



03-5336
MUELLER
65 mm



03-5337
100 mm



03-5338



03-5339



03-5338 - 03-5339
03-5338 70 mm
03-5339 100 mm

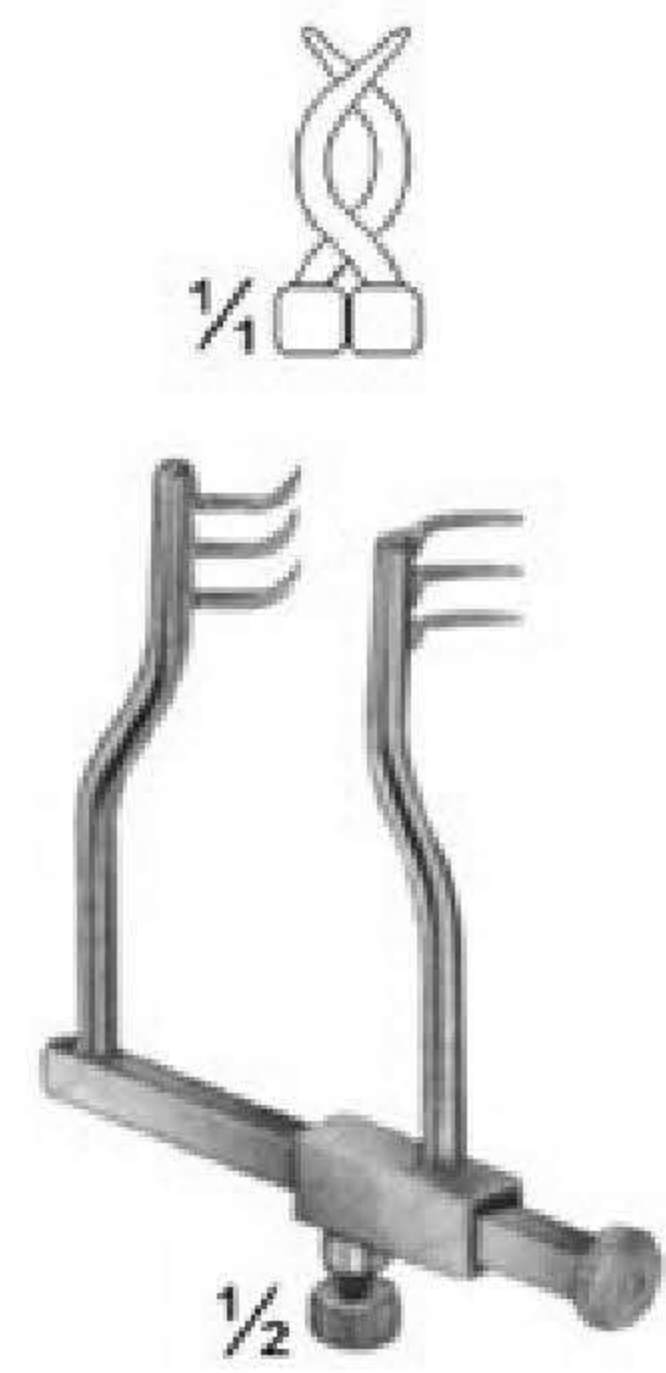

03-5340
LOGAN
modif. REILL
50 mm

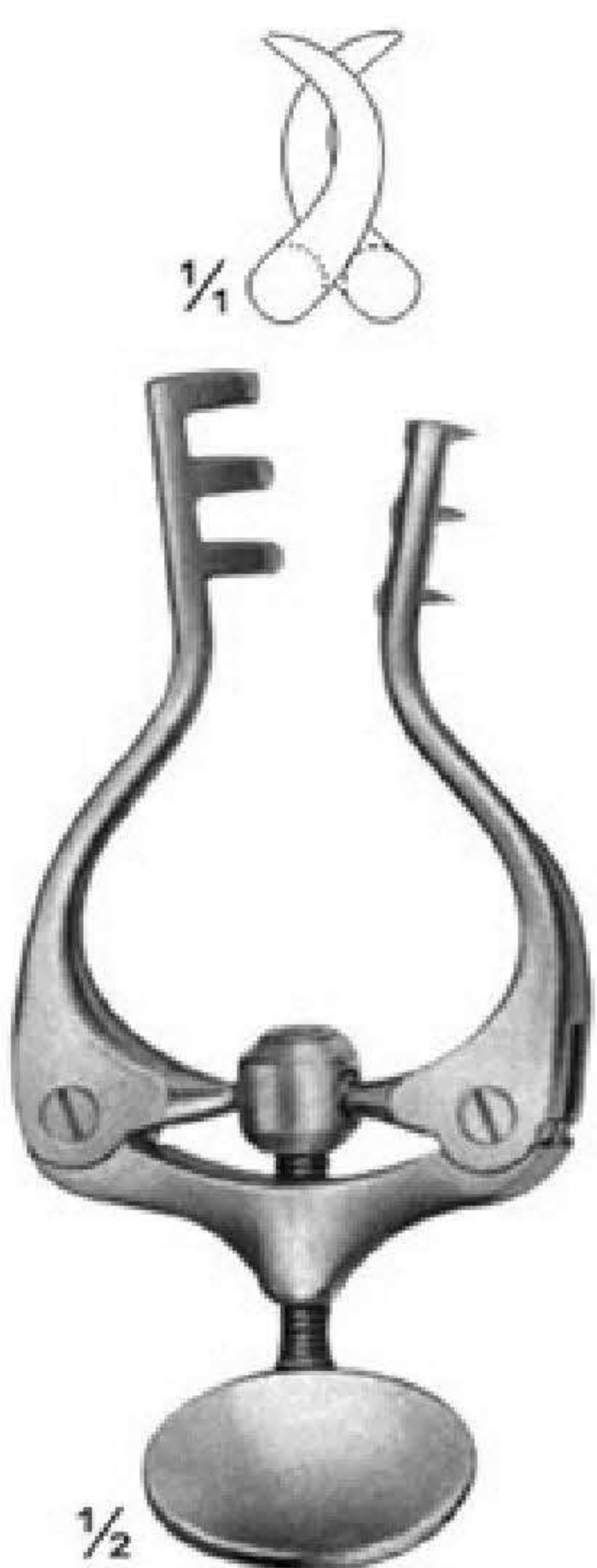

03-5341
JANSEN
100 mm

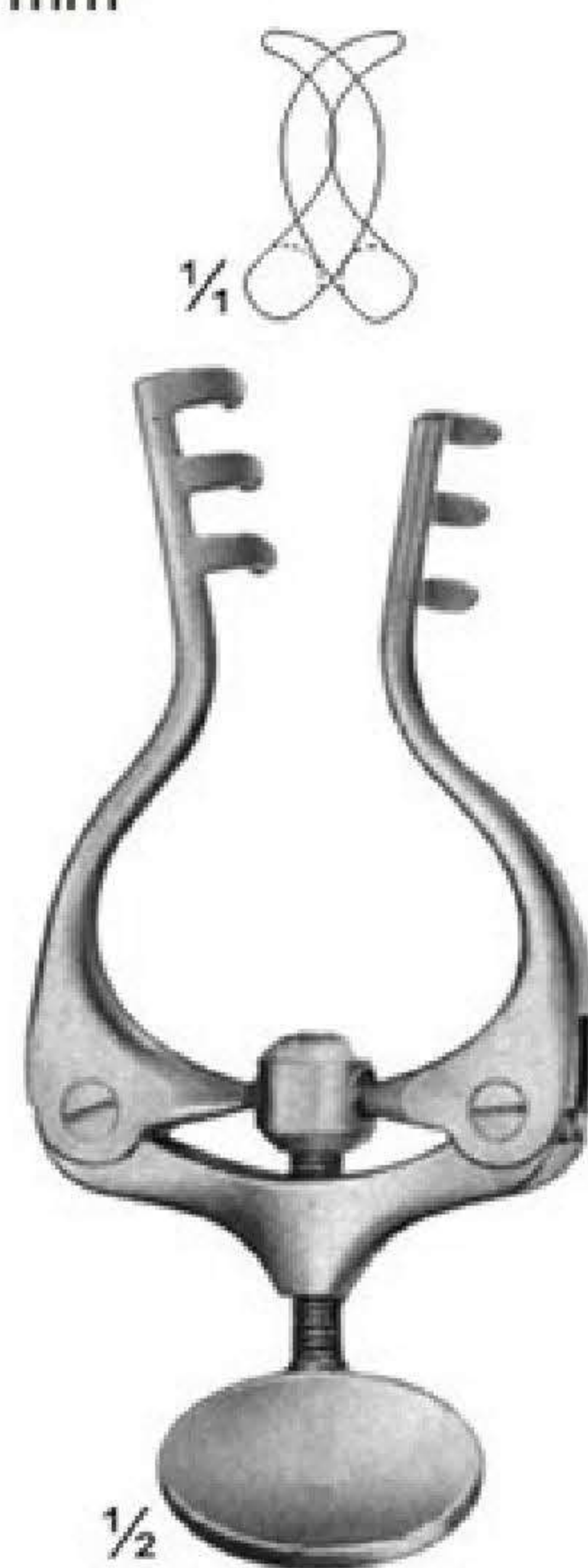

03-5342
JANSEN
100 mm

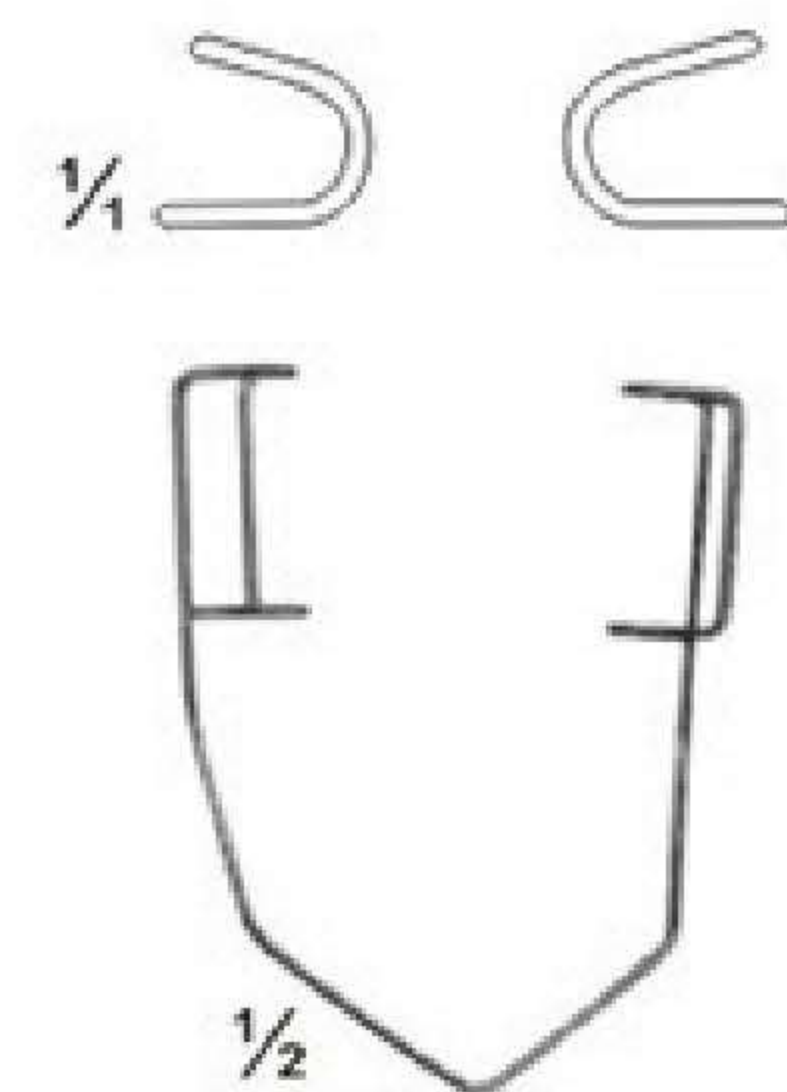

03-5343
BARRAQUER
45 mm

Self-Retaining Retractors

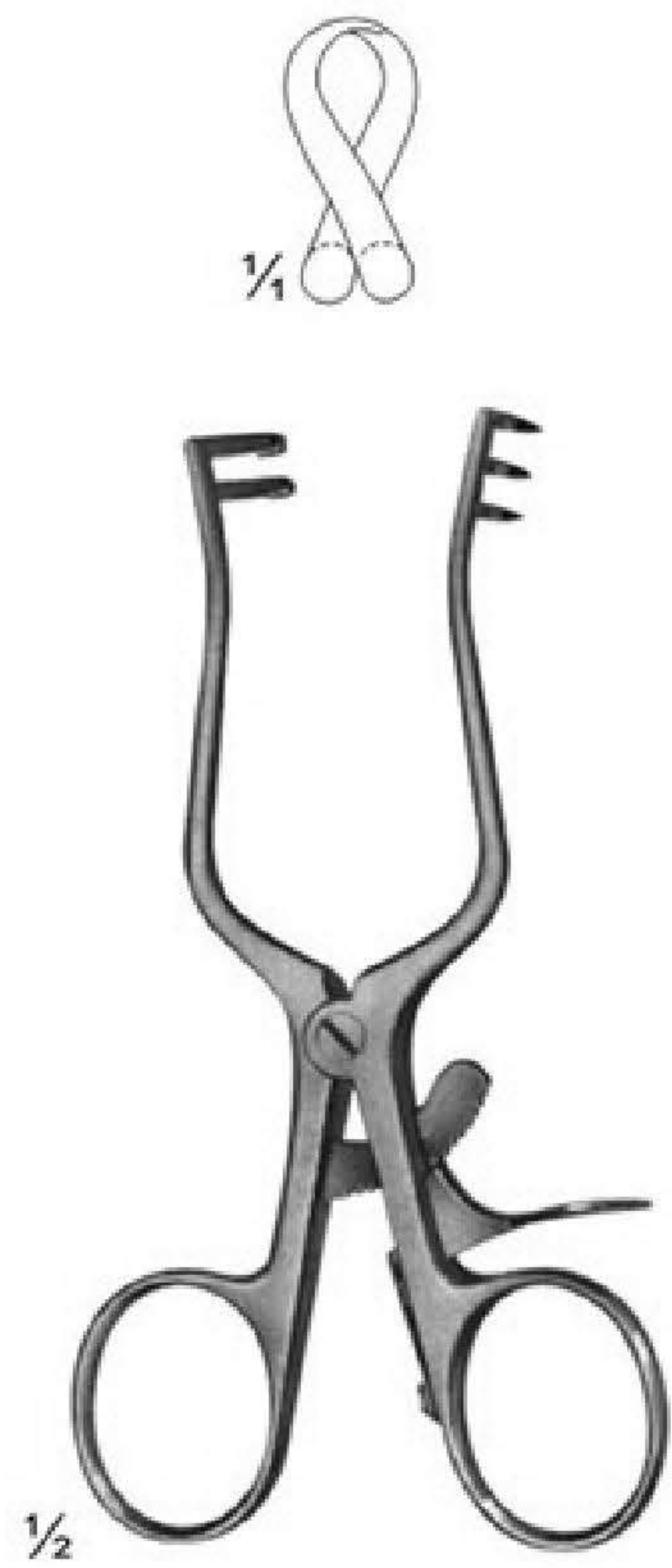

03-5344
 WEITLANER
 Sharp
 110 mm

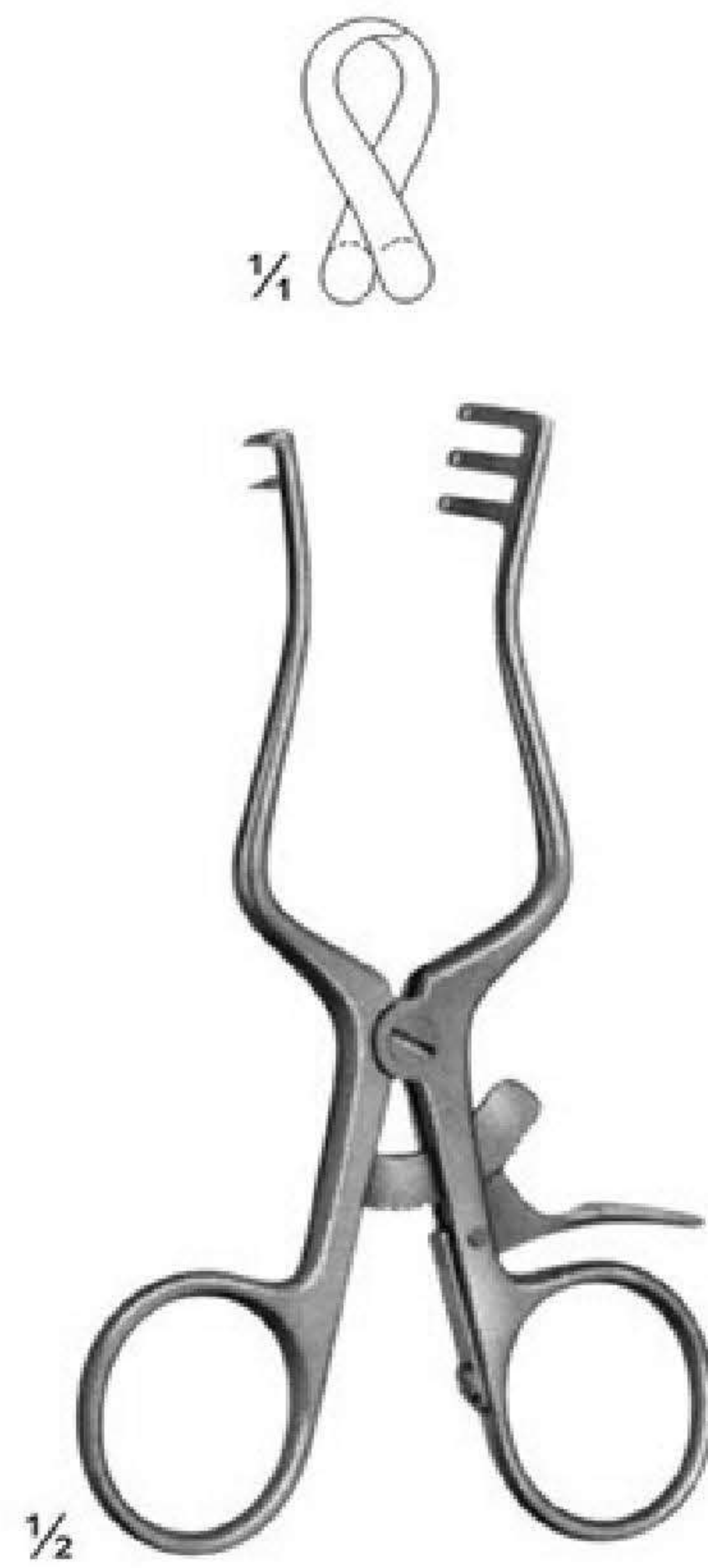

03-5345
 WEITLANER
 Semi-Sharp
 110 mm



03-5346
 WEITLANER
 Blunt
 110 mm



03-5347
 WEITLANER
 Sharp
 130 mm



03-5348
 WEITLANER
 Semi-Sharp
 130 mm



03-5349
 WEITLANER
 Blunt
 130 mm

Self-Retaining Retractors

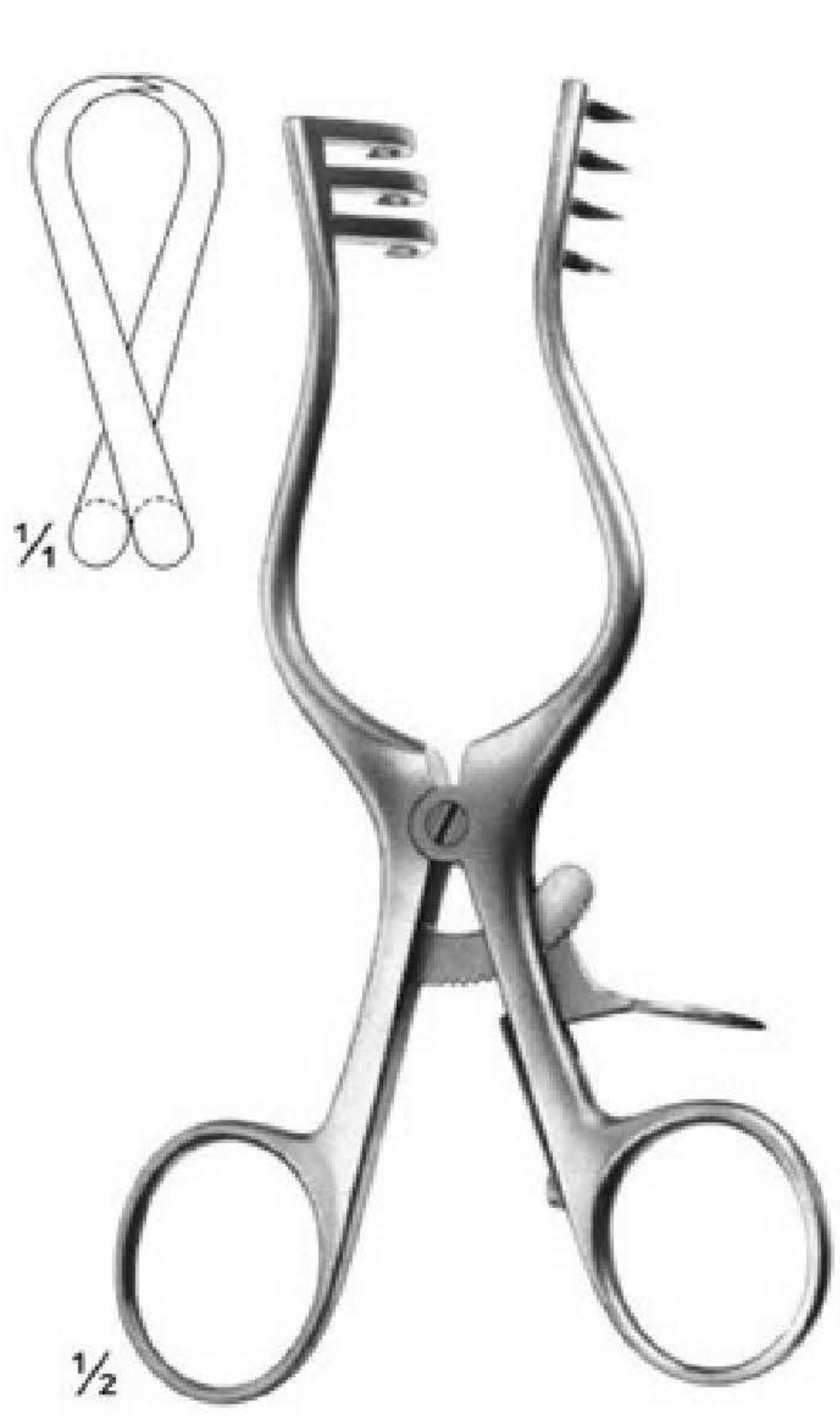

03-5350
WEITLANER
Sharp
130 mm

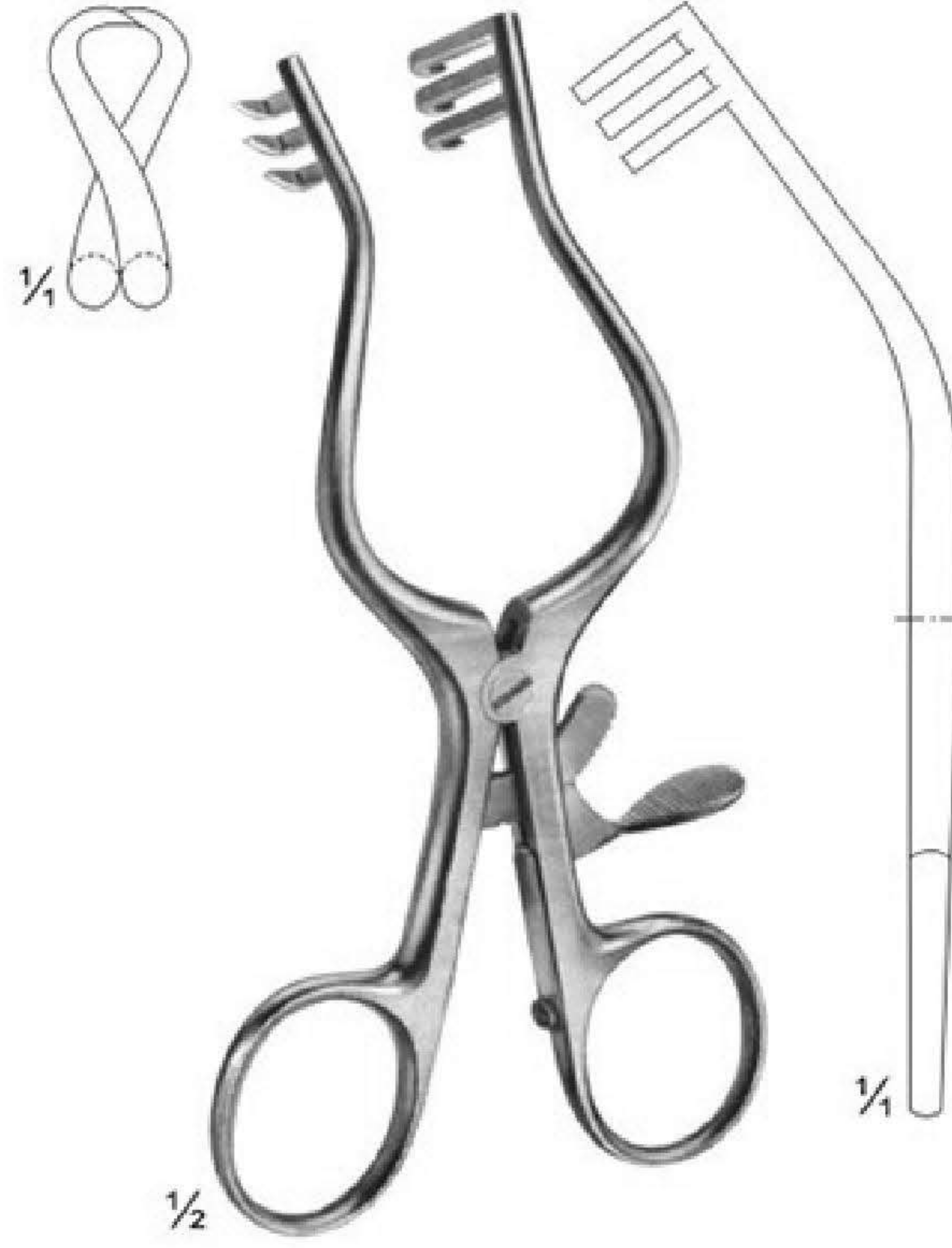

03-5351
WULLSTEIN
Sharp
130 mm

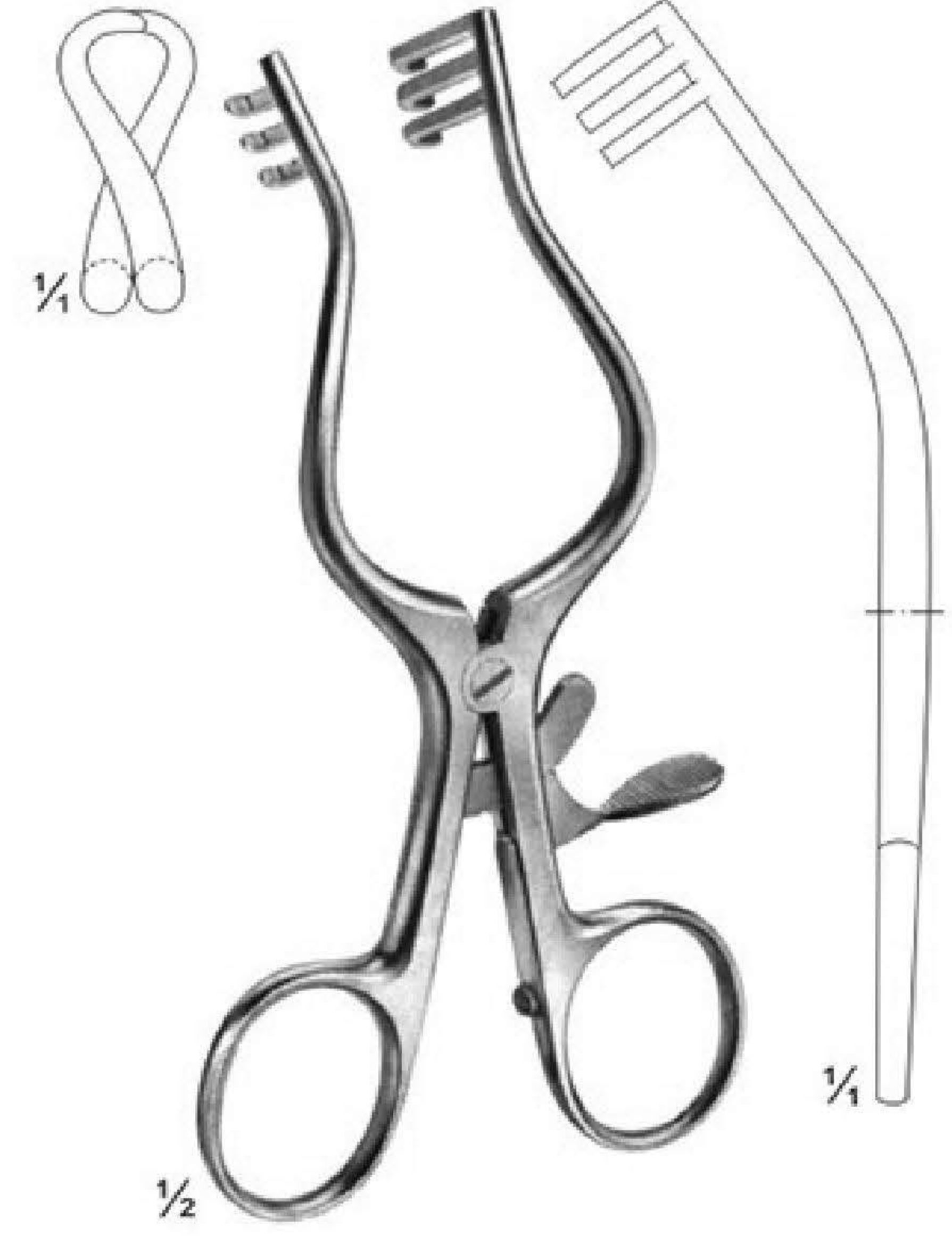

03-5352
WULLSTEIN
Blunt
130 mm



03-5353
WEITLANER
Sharp
165 mm



03-5354
PLESTER
Blunt
110 mm

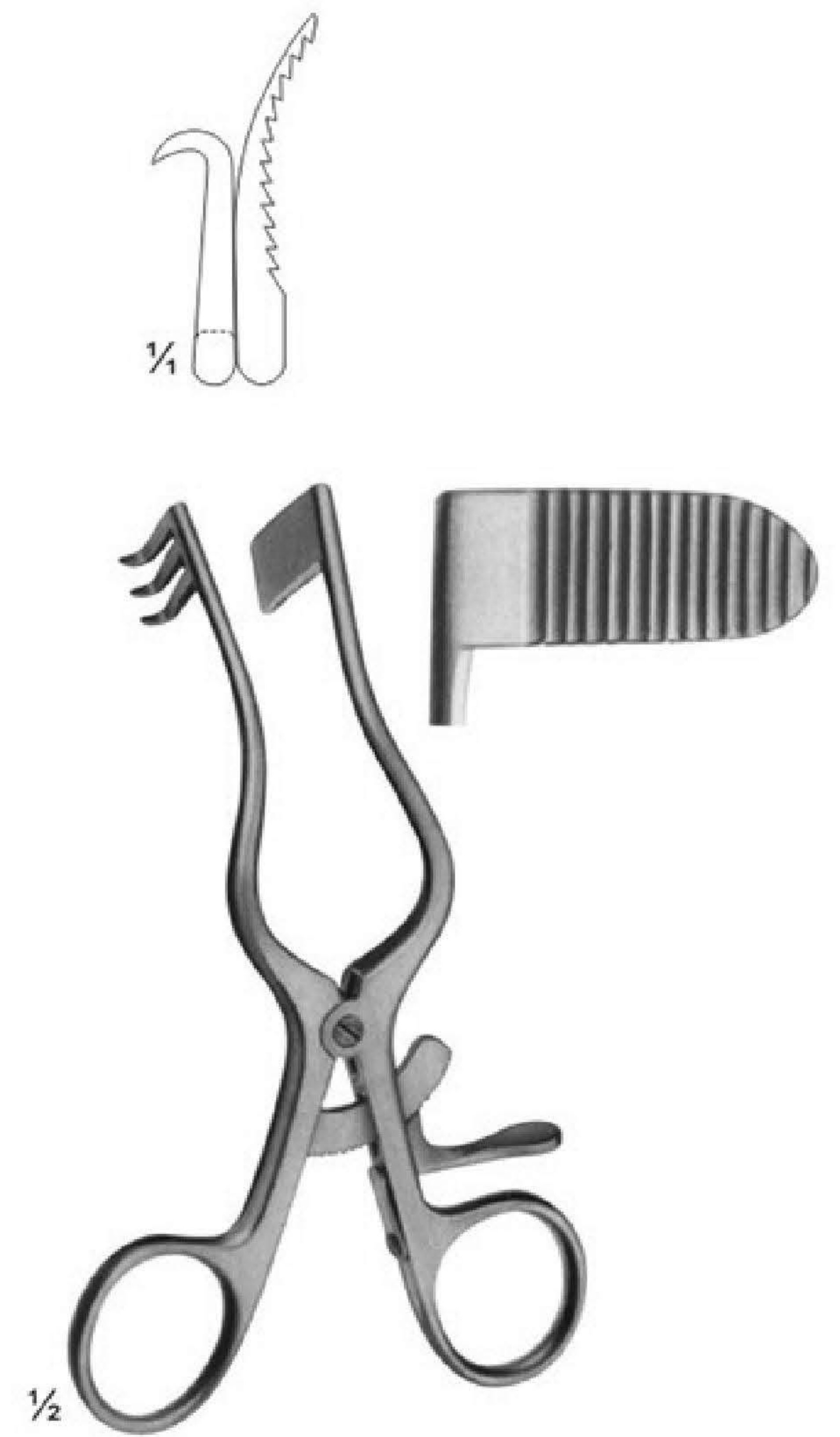

03-5355
PERKINS
130 mm

Self-Retaining Retractors



03-5356
ADSON-BABY
 Blunt
 140 mm

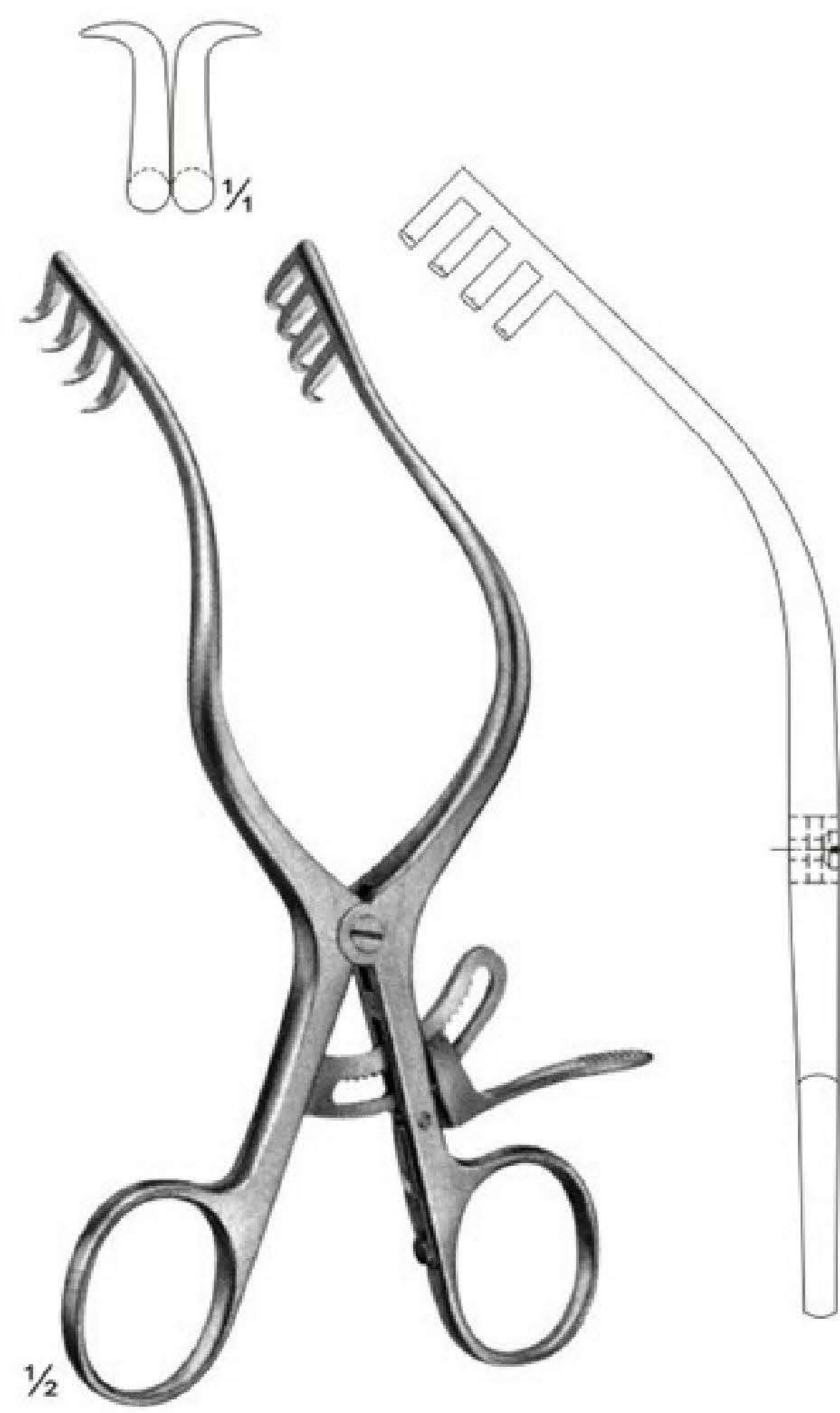

03-5357
MOLLISON
 Sharp
 155 mm



03-5358
MAYO-ADAMS
 165 mm

Self-Retaining Laminectomy Retractors

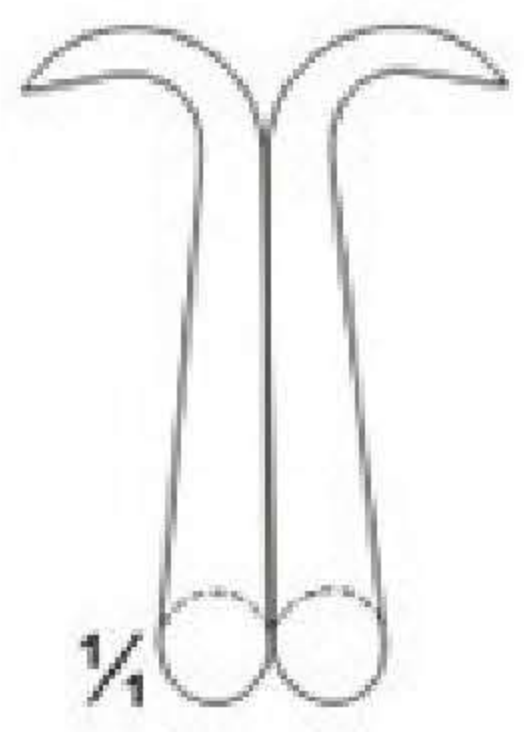

03-5359
 ANDERSON-ADSON
 Sharp
 190 mm

03-5360
 NORFOLK and
 NORWICH
 Blunt
 220 mm

03-5361
 ADSON
 Sharp
 265 mm

Self-Retaining Laminectomy Retractors

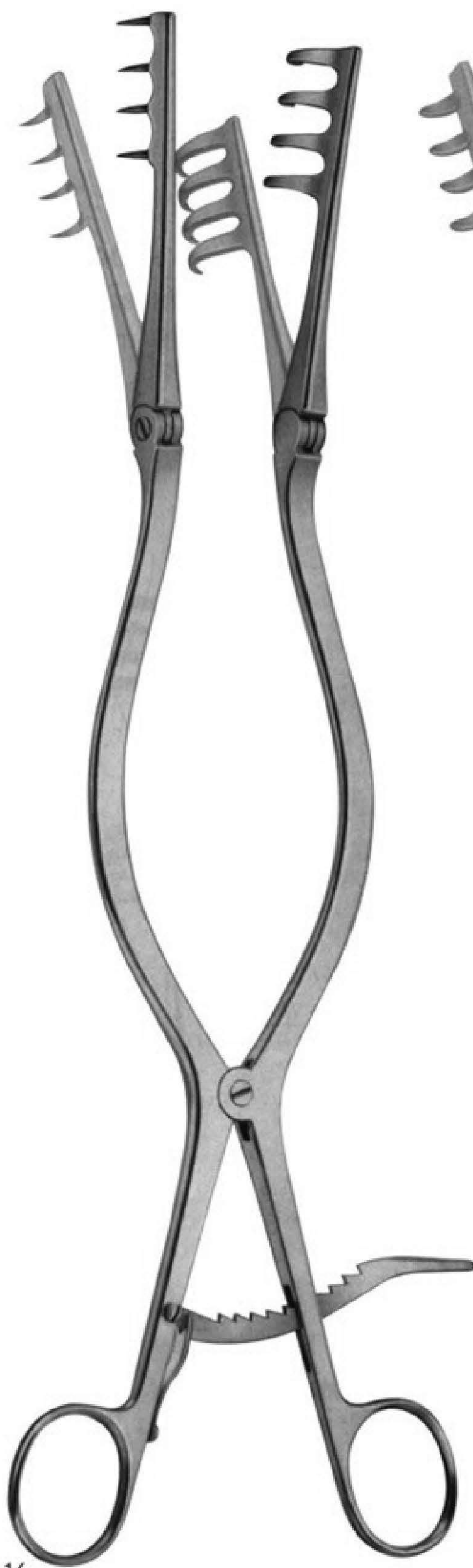
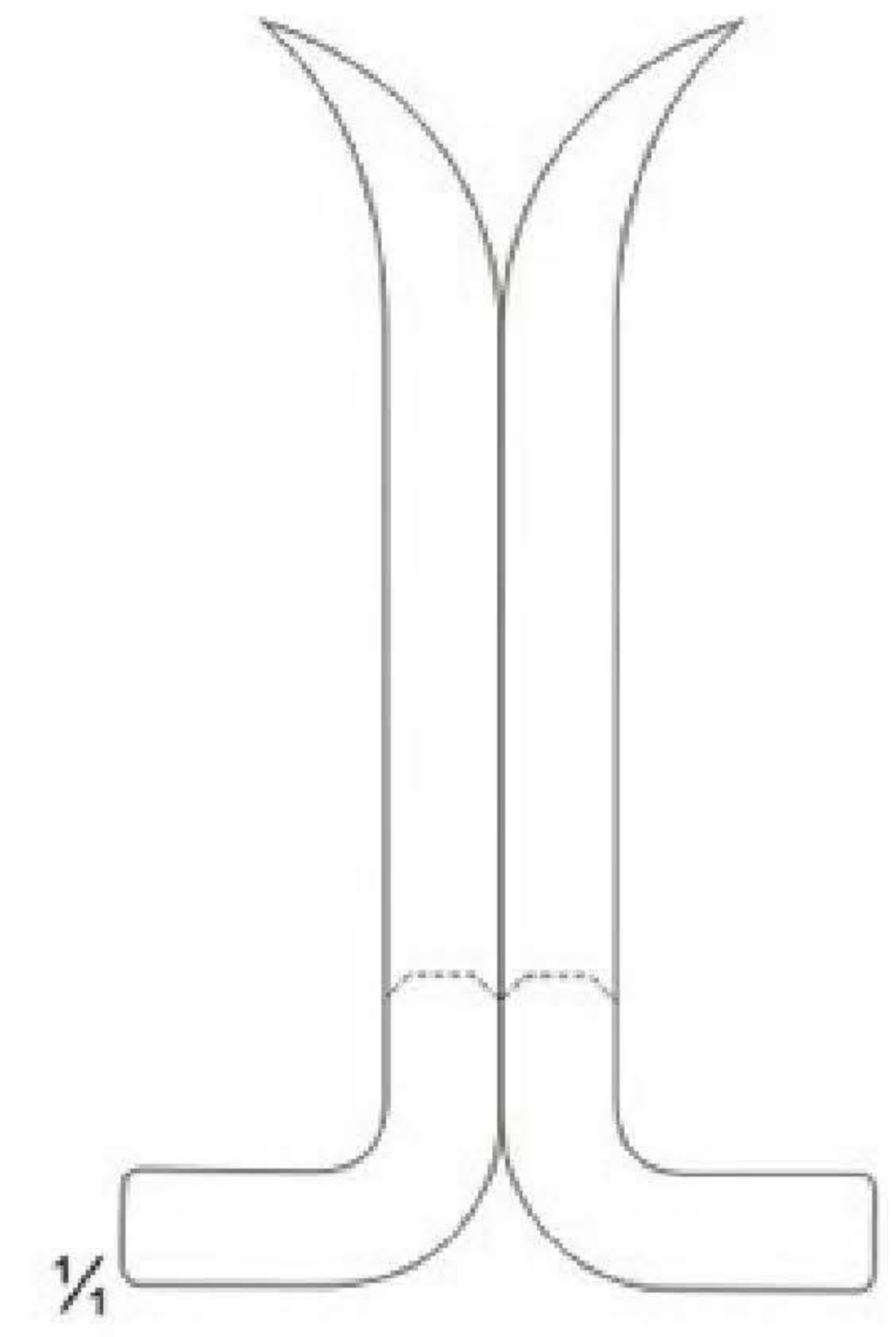
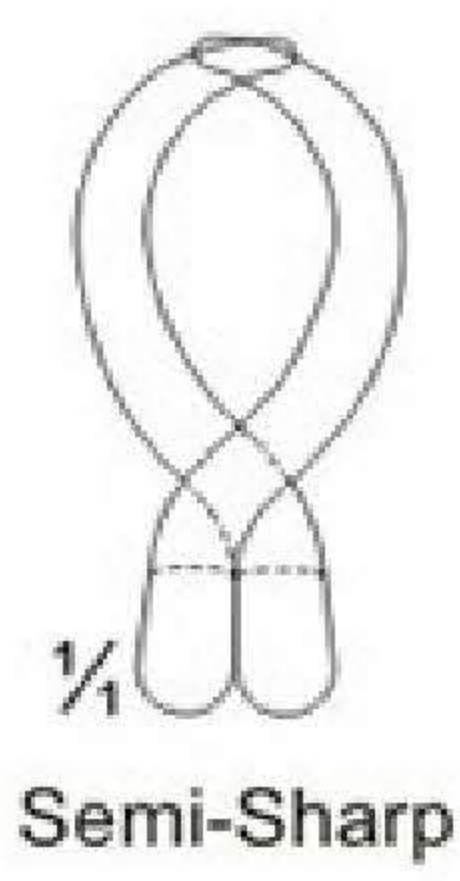

03-5362 - 03-5363
BECKMANN-ADSON
Sharp
310 mm



03-5363
BECKMANN-ADSON
Semi-Sharp
310 mm



03-5364
ADSON
Semi-Sharp
320 mm



03-5365
BECKMANN-EATON
Sharp
320 mm

Special Retractors



03-5366
JOLL (FRIEDMAN)
Thyroid- and Vaginal Retractor
155 mm

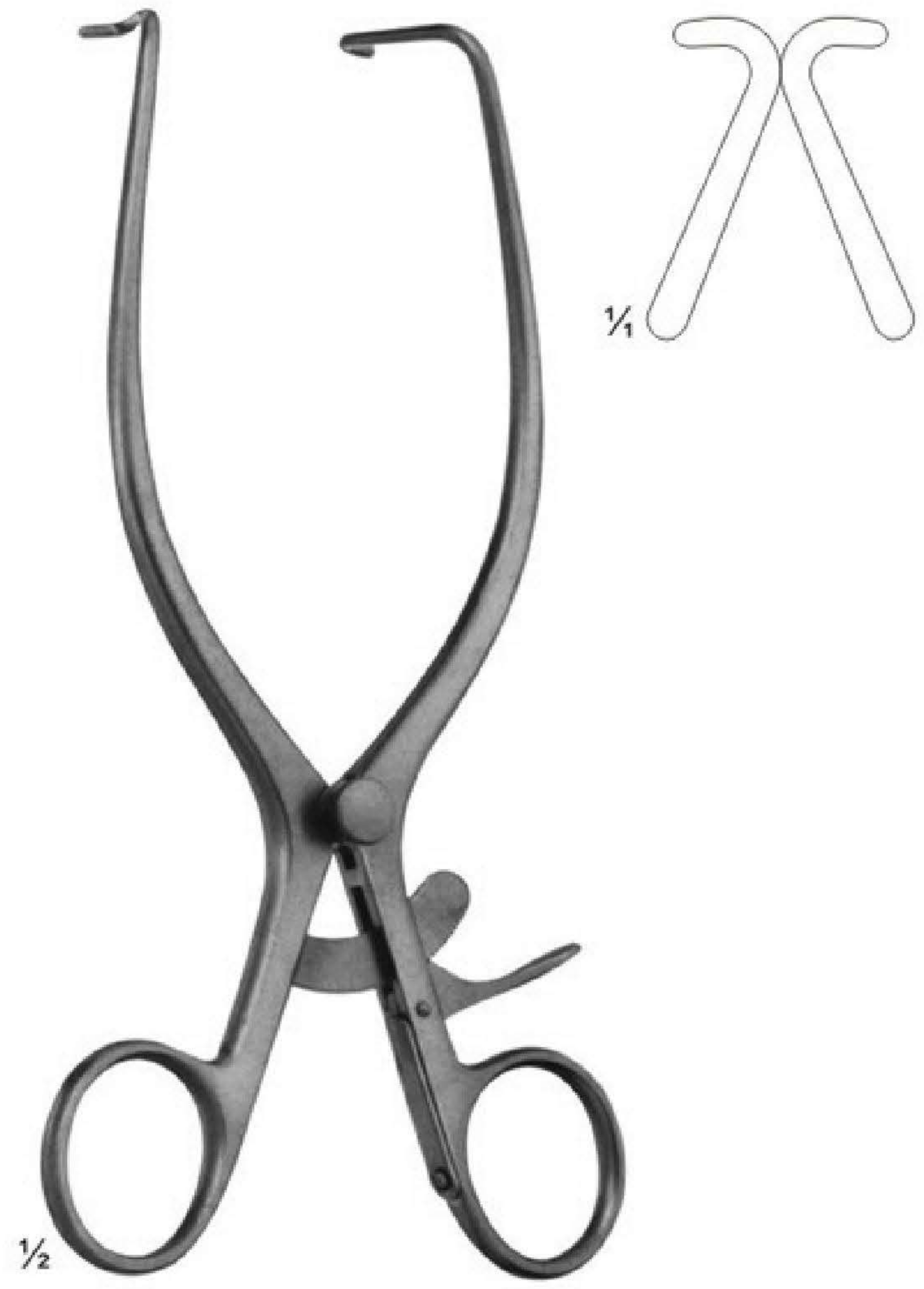

03-5367
JACKSON BURROWS
Retractor, blunt
185 mm

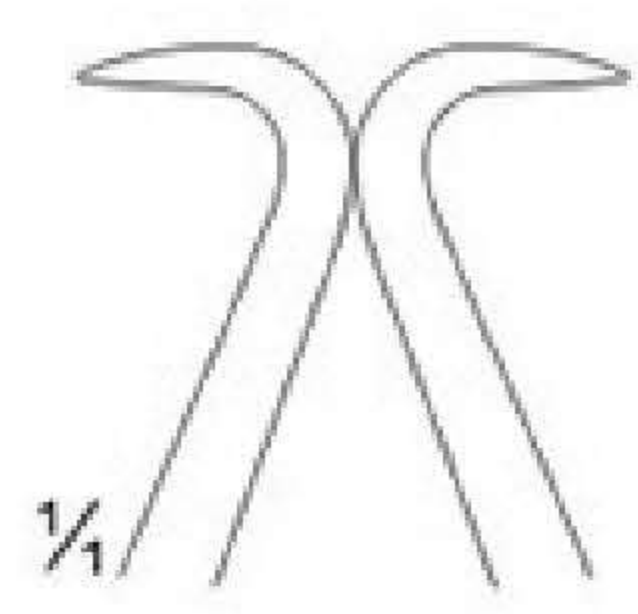

03-5368
GELPI
Vaginal Retractor
135 mm

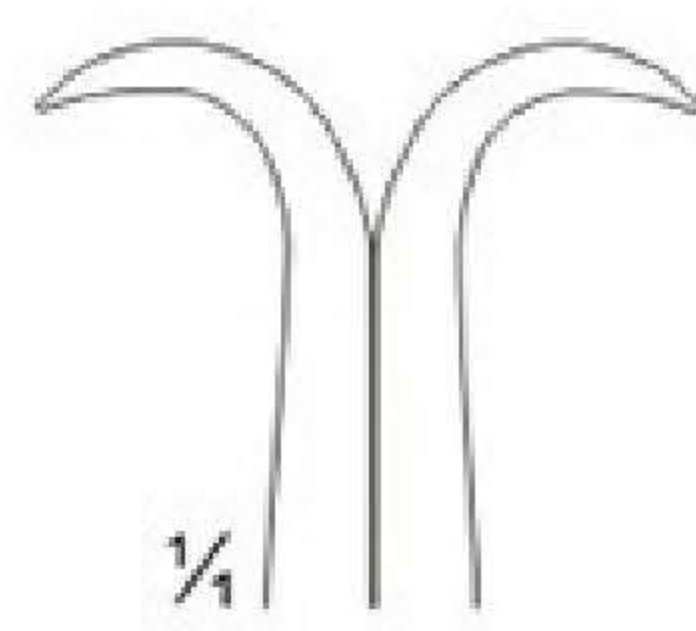

03-5369
GELPI
Skin- and Vaginal Retractor
175 mm

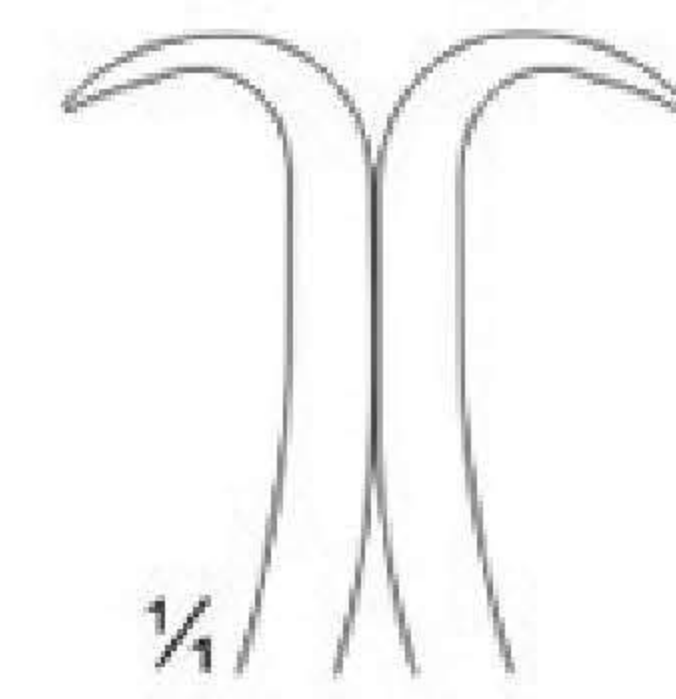

03-5370
DE BAKEY
Femur Retractor
145 mm

Self Retaining Retractors for Laminectomy and other Operations

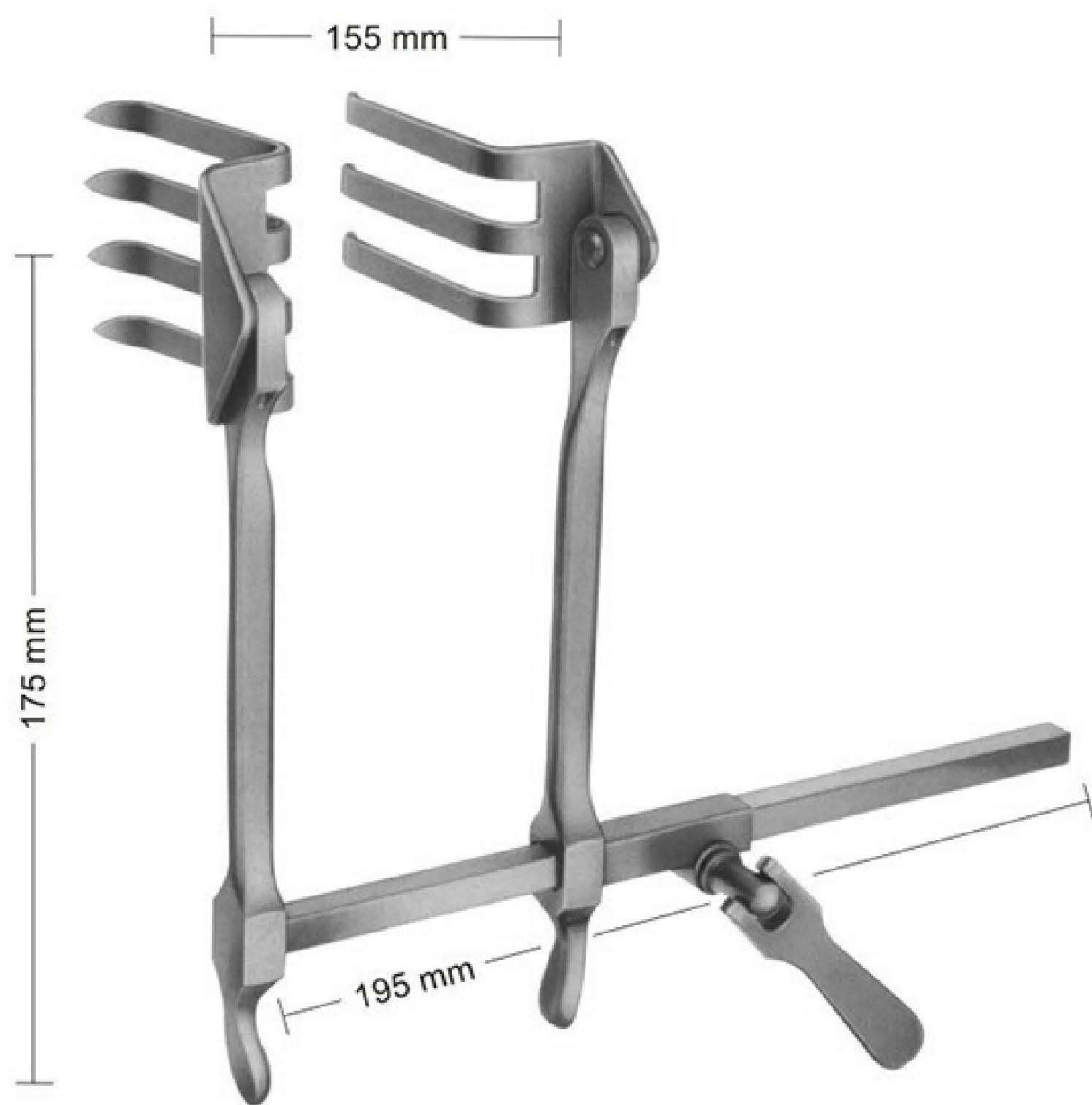

03-5371
 SCOVILLE-RICHTER
 Retractor with 1 pair
 blades reversible type.
 The Retractor bar and shanks
 may be easily rotated 180° when
 blades are in situ.



03-5372
 62 x 52 mm
 PR= Pair

03-5373
 62 x 37 mm



03-5373
 47 x 51 mm



03-5374
 30 x 40 mm



03-5375
 37 x 62 mm

Retractors for Cervical Spine



03-5376
CLOWARD modif.
Spreader Only
Consisting of:
Spreader Only
03-5377 1 Blade
03-5378 1 Blade
03-5379 1 Blade
03-5380 1 Blade
03-5381 1 Blade

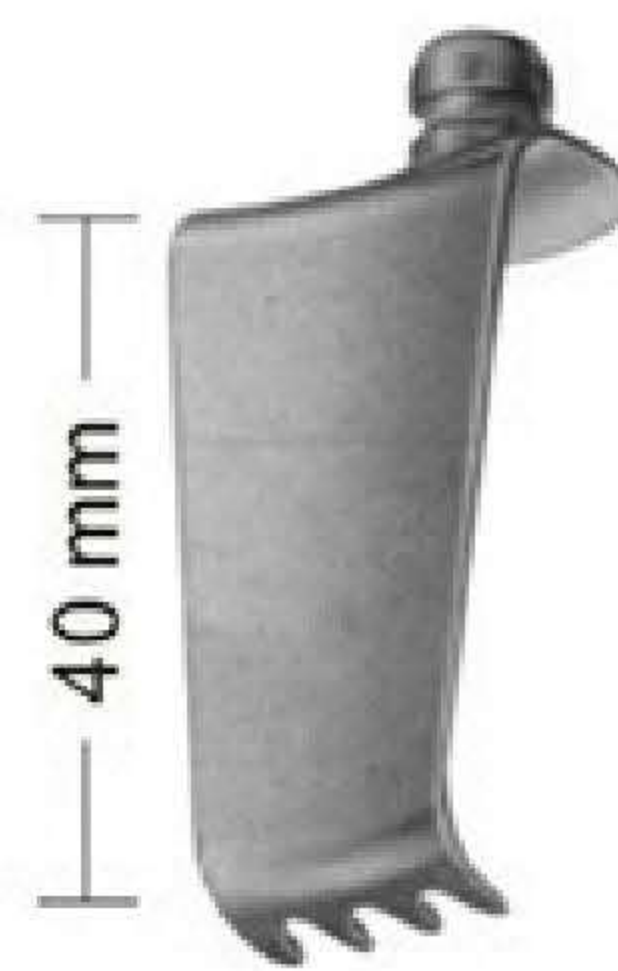

16 mm
03-5377



16 mm
03-5378



16 mm
03-5382

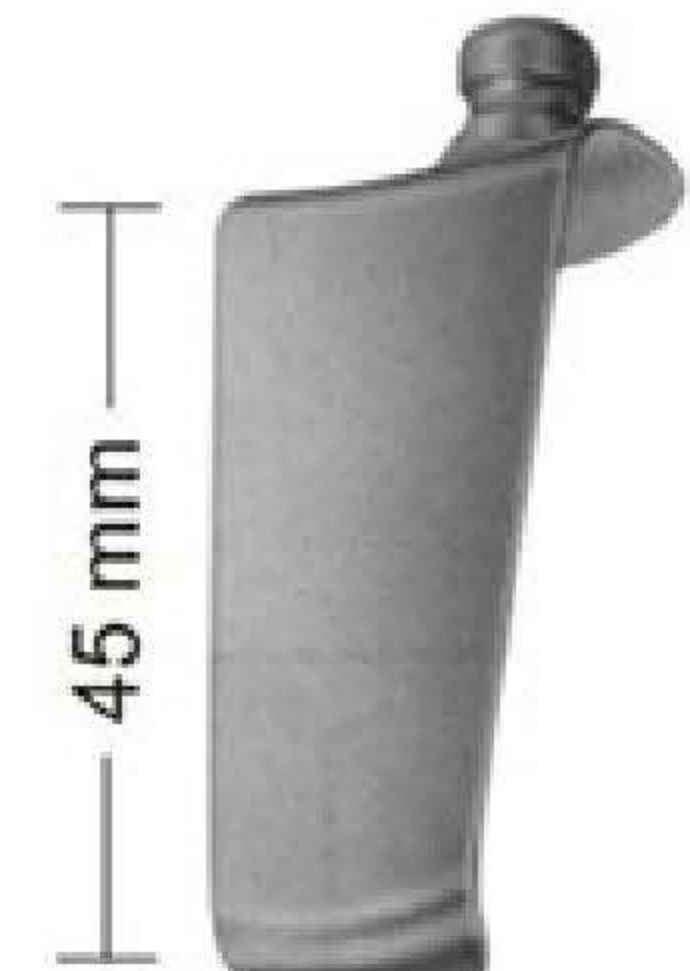

16 mm
03-5383

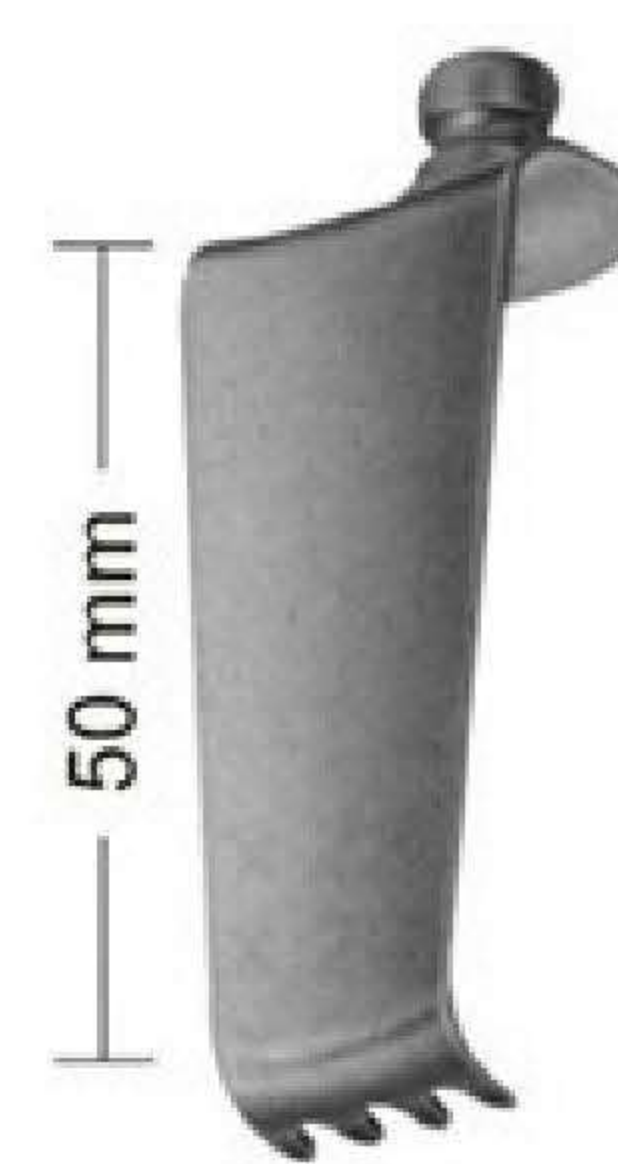

16 mm
03-5379



16 mm
03-5380



16 mm
03-5384

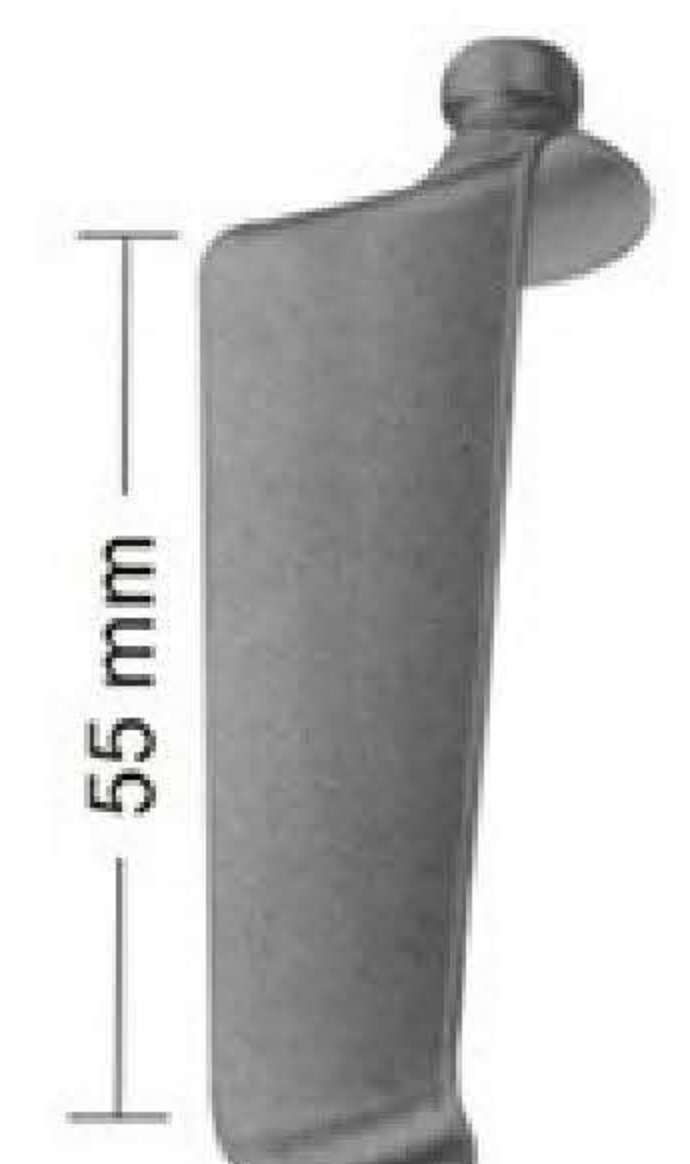

16 mm
03-5385

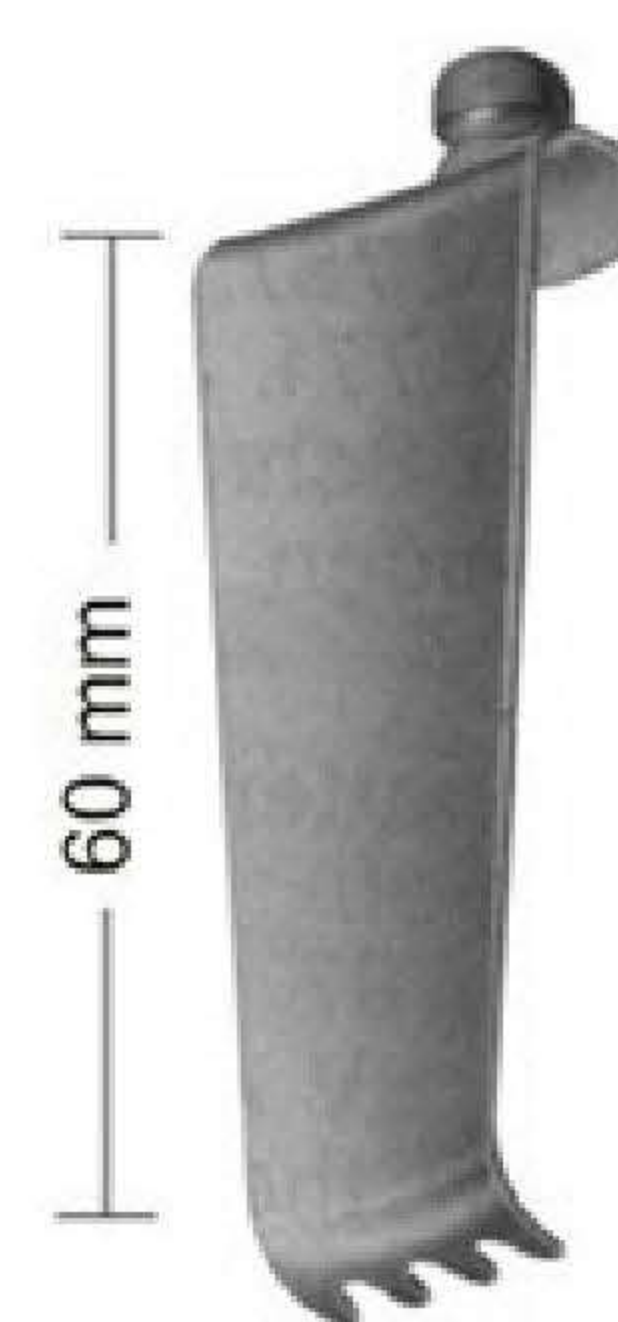

16 mm
03-5381

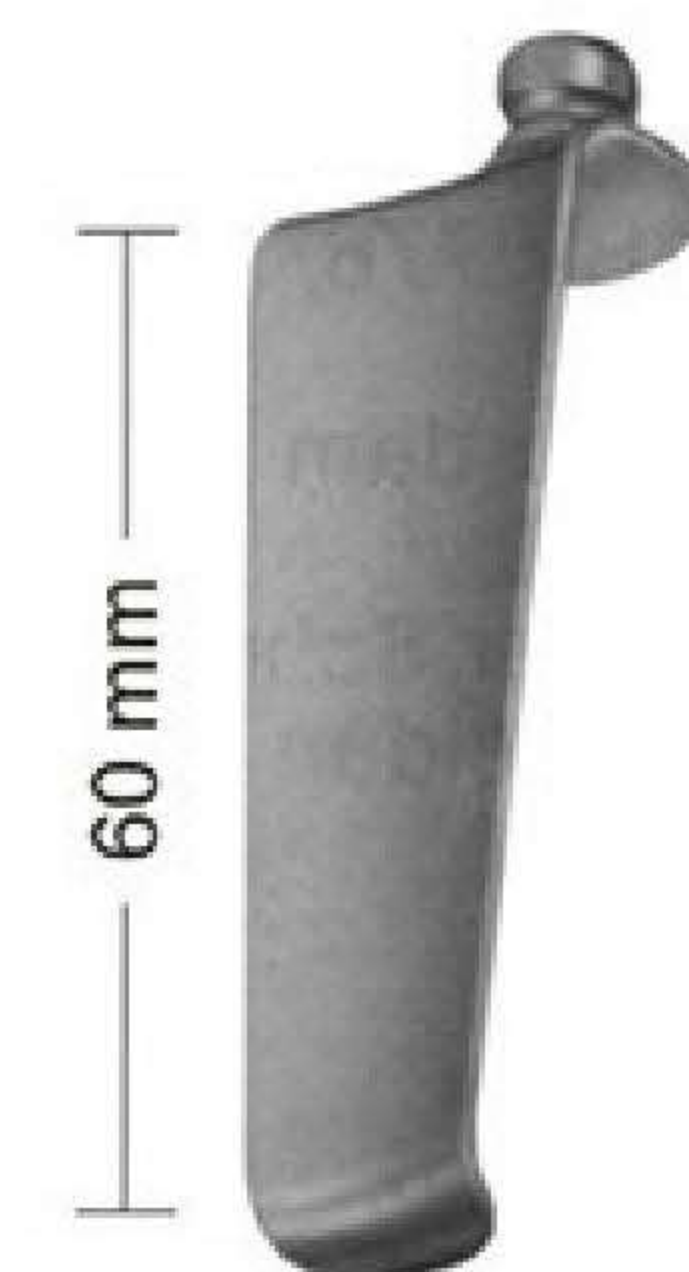

16 mm
03-5386

Blades only used for **03-5376**

Retractors for Cervical Vertebral Column

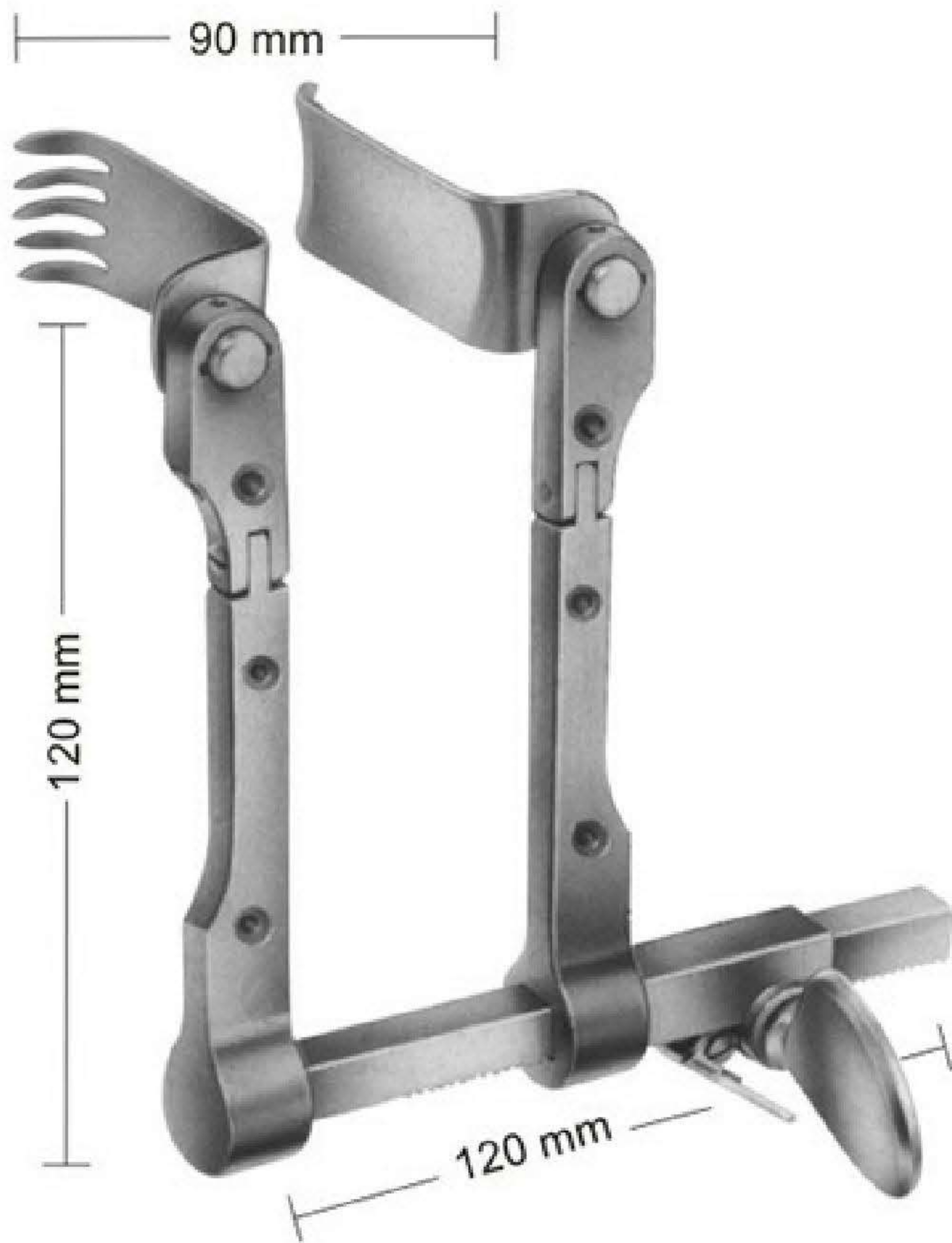

03-5387
CASPAR
Retractor, adjustable, consisting of:
5 medial blades (03-5389 - 03-5393) 5 Lateral
blades. (03-5394 - 03-5398) and the retractor
only By Reversing the Screw,
The Retractor Can be Used From Both Sides

To be used preferably for transverse retraction.

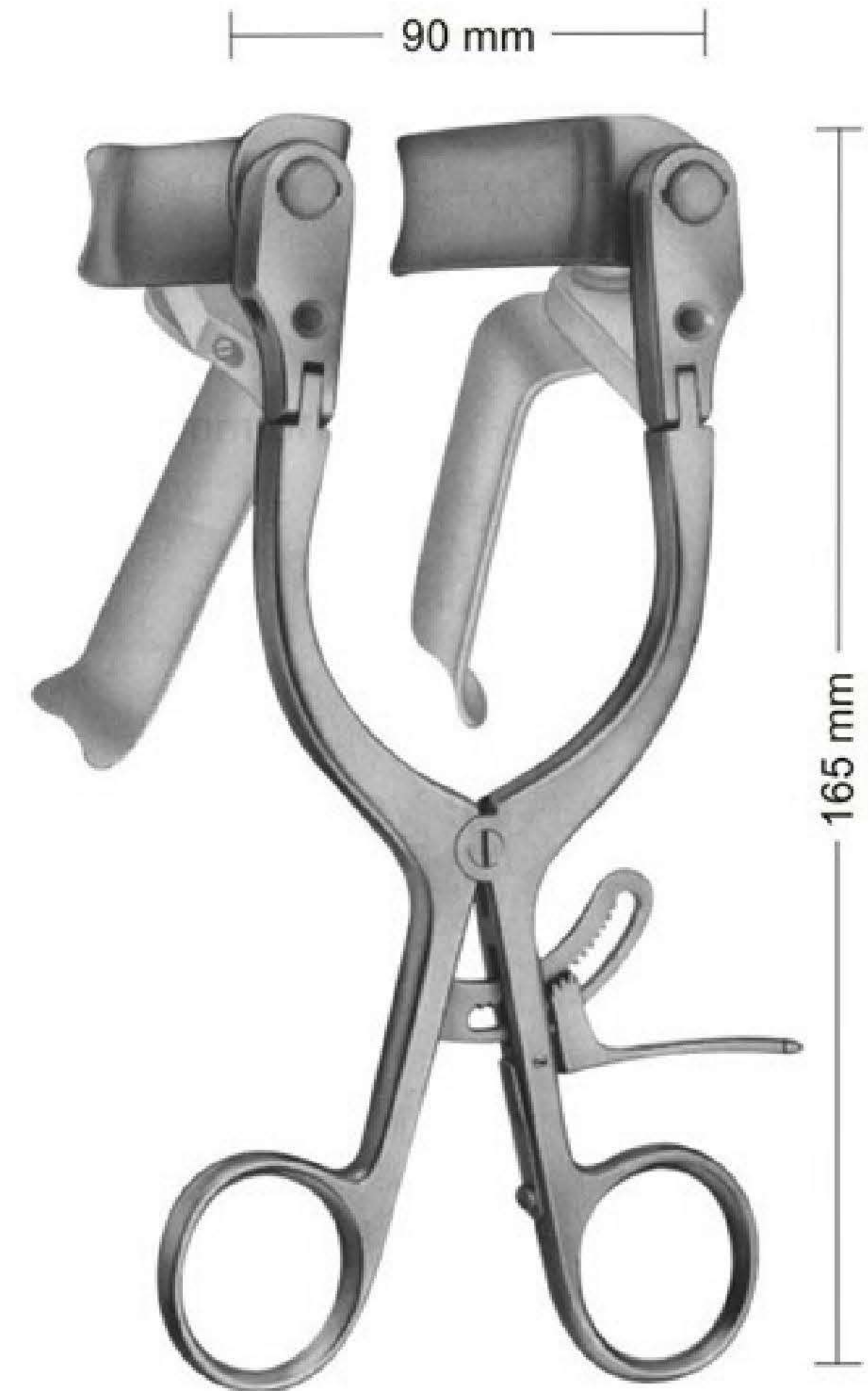

03-5388
CASPAR
Counter retractor, adjustable,
consisting of: 5 blades. (03-5399 - 03-5403)
and the retractor only

To be used preferably for
up and down retraction.



03-5389 40 x 23 mm
03-5390 45 x 23 mm
03-5391 50 x 23 mm
03-5392 55 x 23 mm
03-5393 60 x 23 mm
Medial blades

03-5394 40 x 23 mm
03-5395 45 x 23 mm
03-5396 50 x 23 mm
03-5397 55 x 23 mm
03-5398 60 x 23 mm
Lateral blades

03-5399 45 x 23 mm
03-5400 50 x 23 mm
03-5401 55 x 23 mm
03-5402 60 x 23 mm
03-5403 65 x 23 mm
Blunt blades

03-5404 50 x 25 mm
03-5405 60 x 25 mm
Blunt blades,
for harvesting of the
fusion graft from the
iliac crest

03-5406 40 x 25 mm
03-5407 45 x 25 mm
03-5408 50 x 25 mm
03-5409 55 x 25 mm
03-5410 60 x 25 mm
Medial Titan blades
semi transparent to x-ray

03-5411 40 x 25 mm
03-5412 45 x 25 mm
03-5413 50 x 25 mm
03-5414 55 x 25 mm
03-5415 60 x 25 mm
Lateral Titan blades
semi transparent to x-ray

Lamina Spreaders



03-5416
CLOWARD
155 mm



03-5417
CLOWARD
135 mm



03-5418
INGE
170 mm

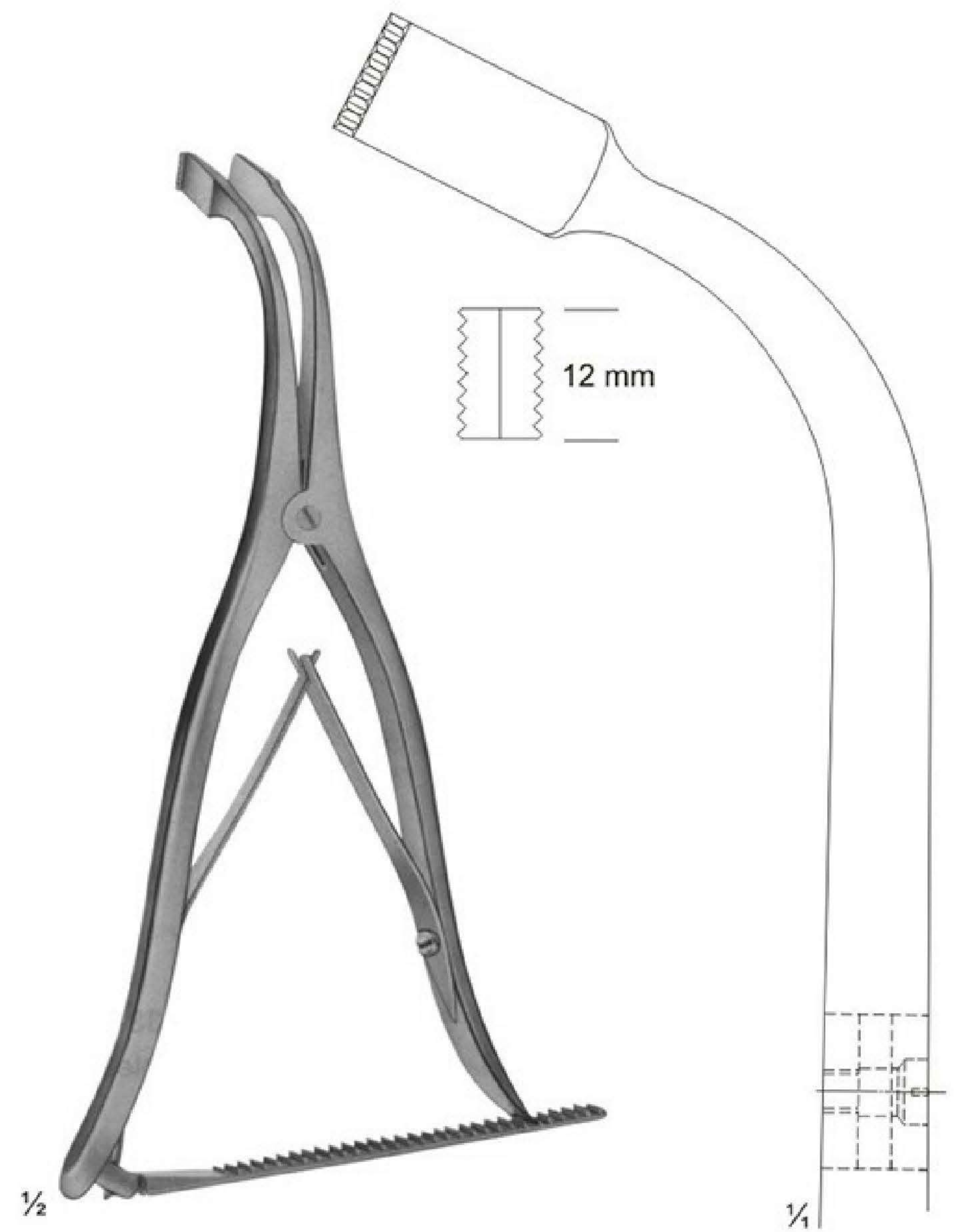

03-5419
INGE
275 mm

Abdominal Retractors



03-5420
 BABY-COLLIN
 with 2 pair of blades



03-5421
 COLLIN
 complete



03-5422
 COLLIN
 complete



03-5423
 RICARD
 complete
 Spreader only
 Lateral blade
 Center blade



03-5424
 HOLZBACH
 Complete
 Spreader only
 Lateral blade 59x80mm
 Center blade 74x82mm

Abdominal Baldes

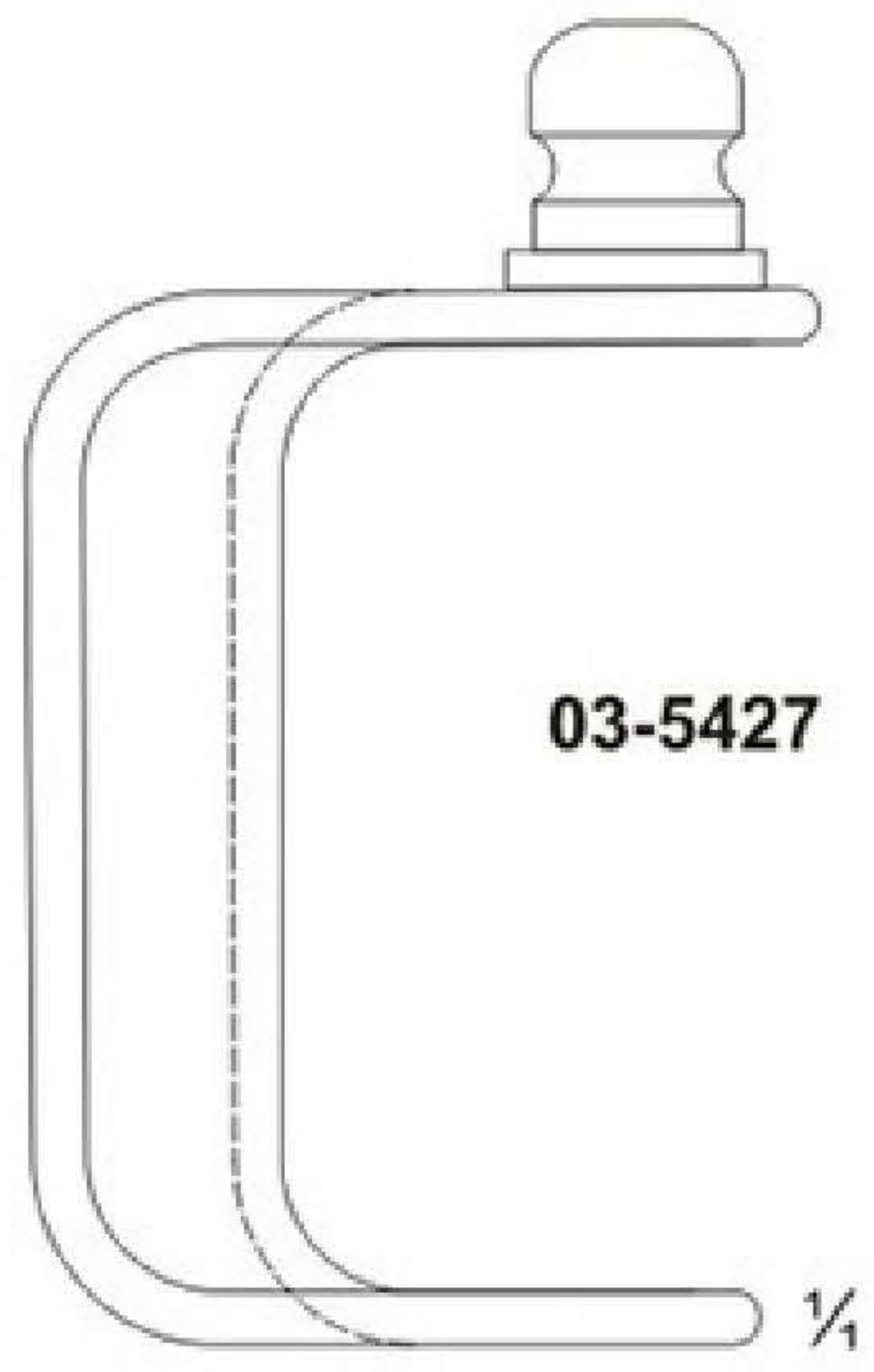

03-5427

Lateral blades only
 03-5425 37x62 mm
 03-5426 37x80 mm
 03-5427 37x98 mm

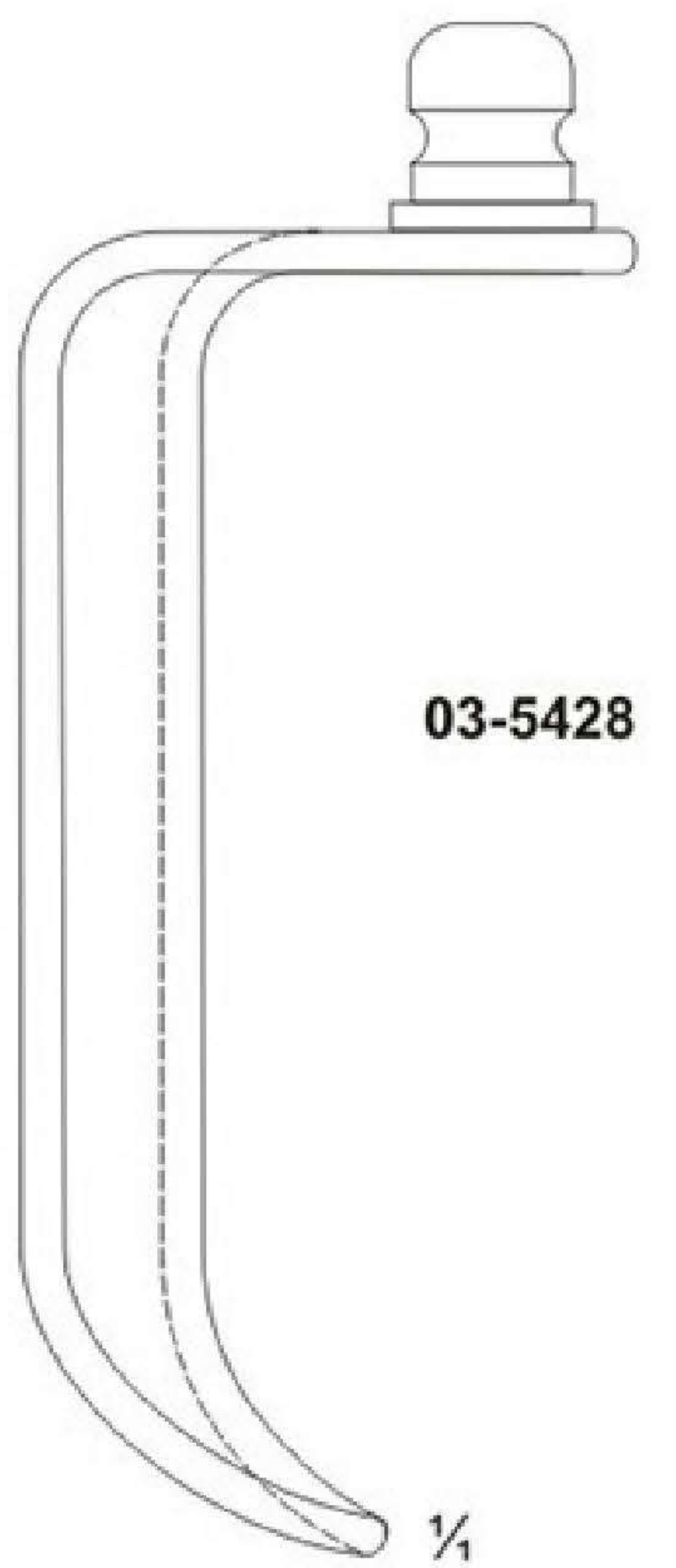

03-5428

03-5428 61x80 mm

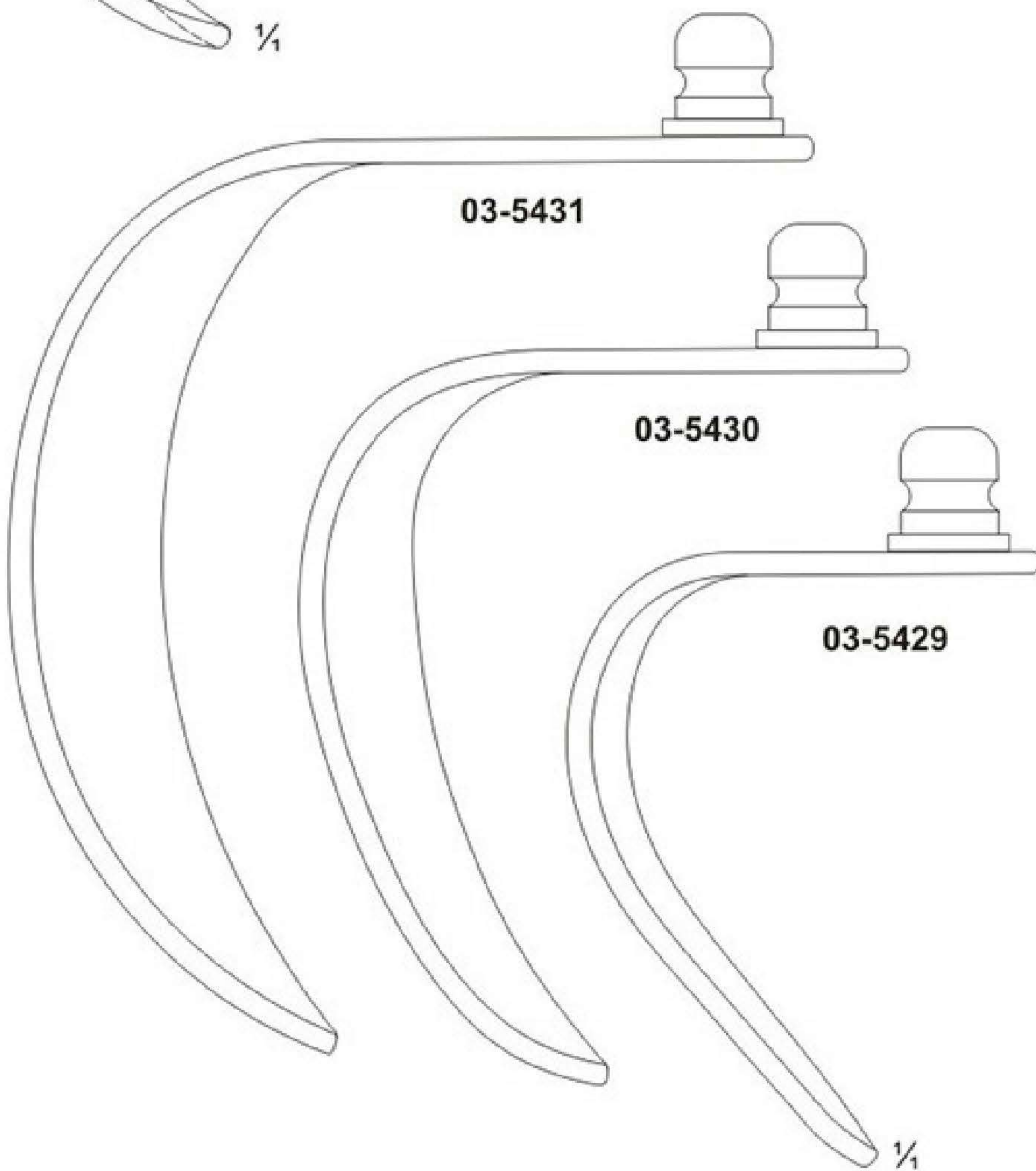

03-5431

03-5430

03-5429

03-5429 48x59 mm
 03-5430 58x80 mm
 03-5431 72x84 mm



03-5432 59x80 mm



Abdominal Retractors



03-5433
GOSSET
 Blades:38 mm deep

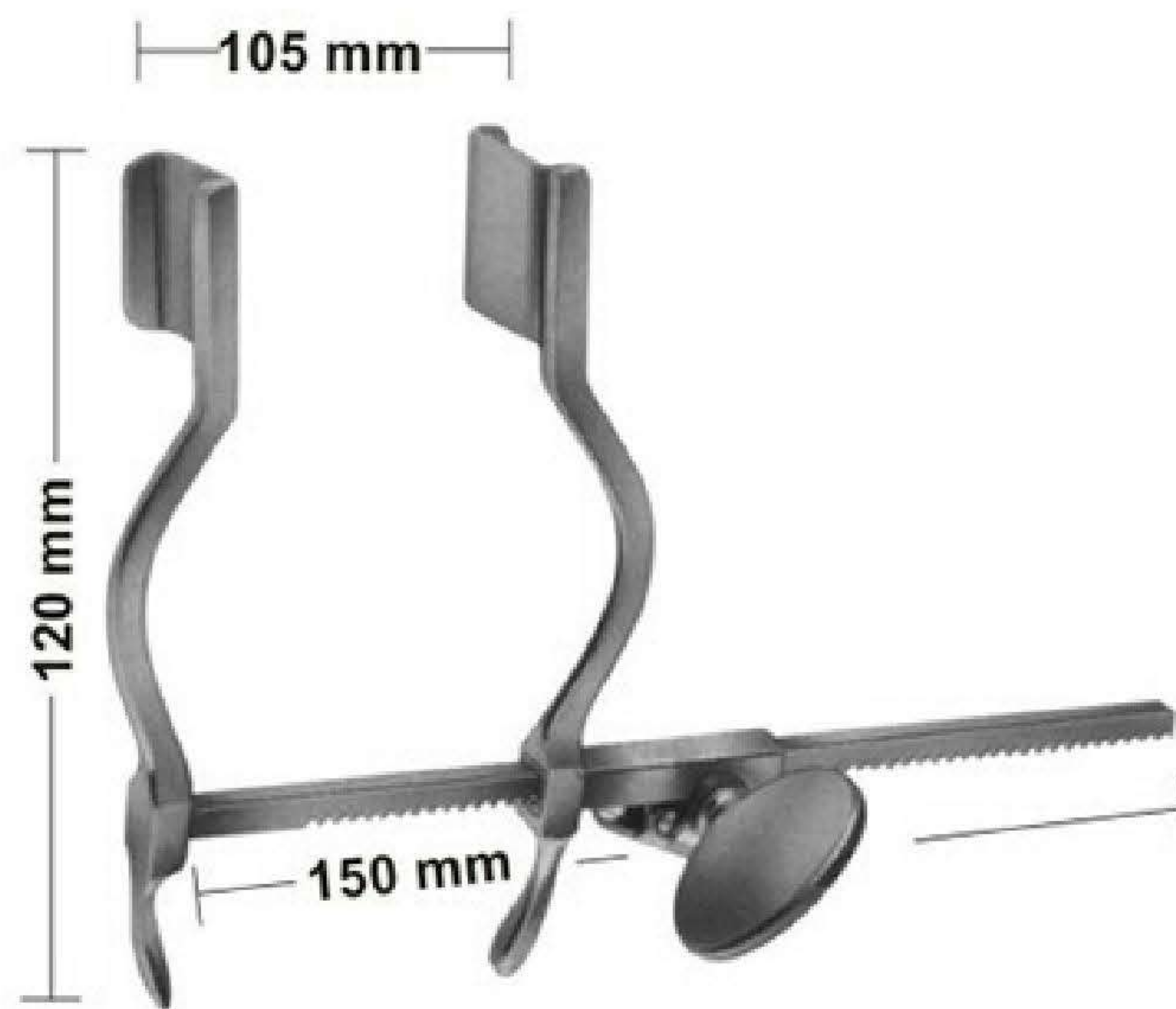

03-5434
HERTZLER
 Blades 20 X 25 mm

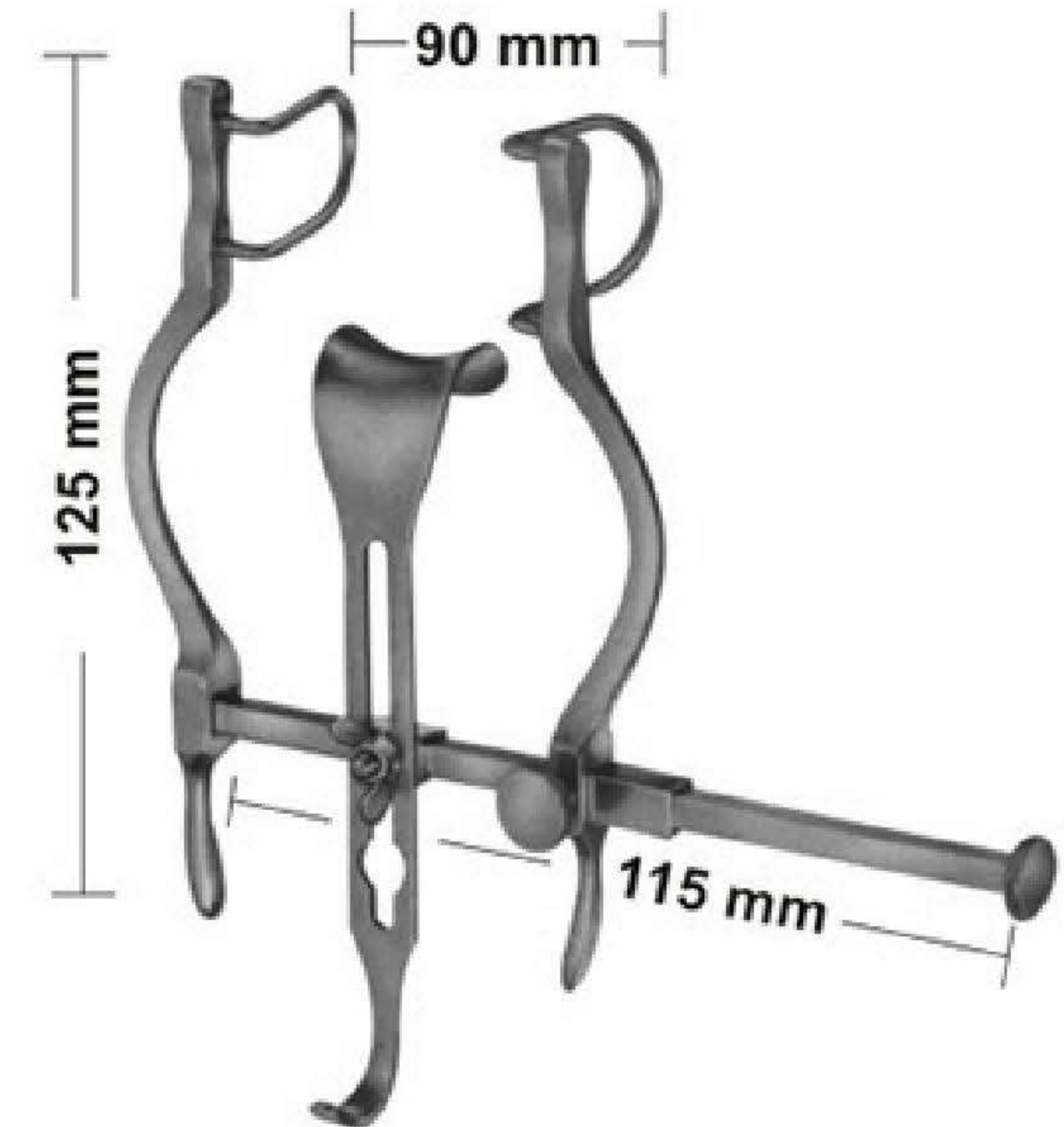

03-5435
BALFOUR-BABY
 Lateral blades 27 mm deep
 (03-5435) Center blade 21x24 mm

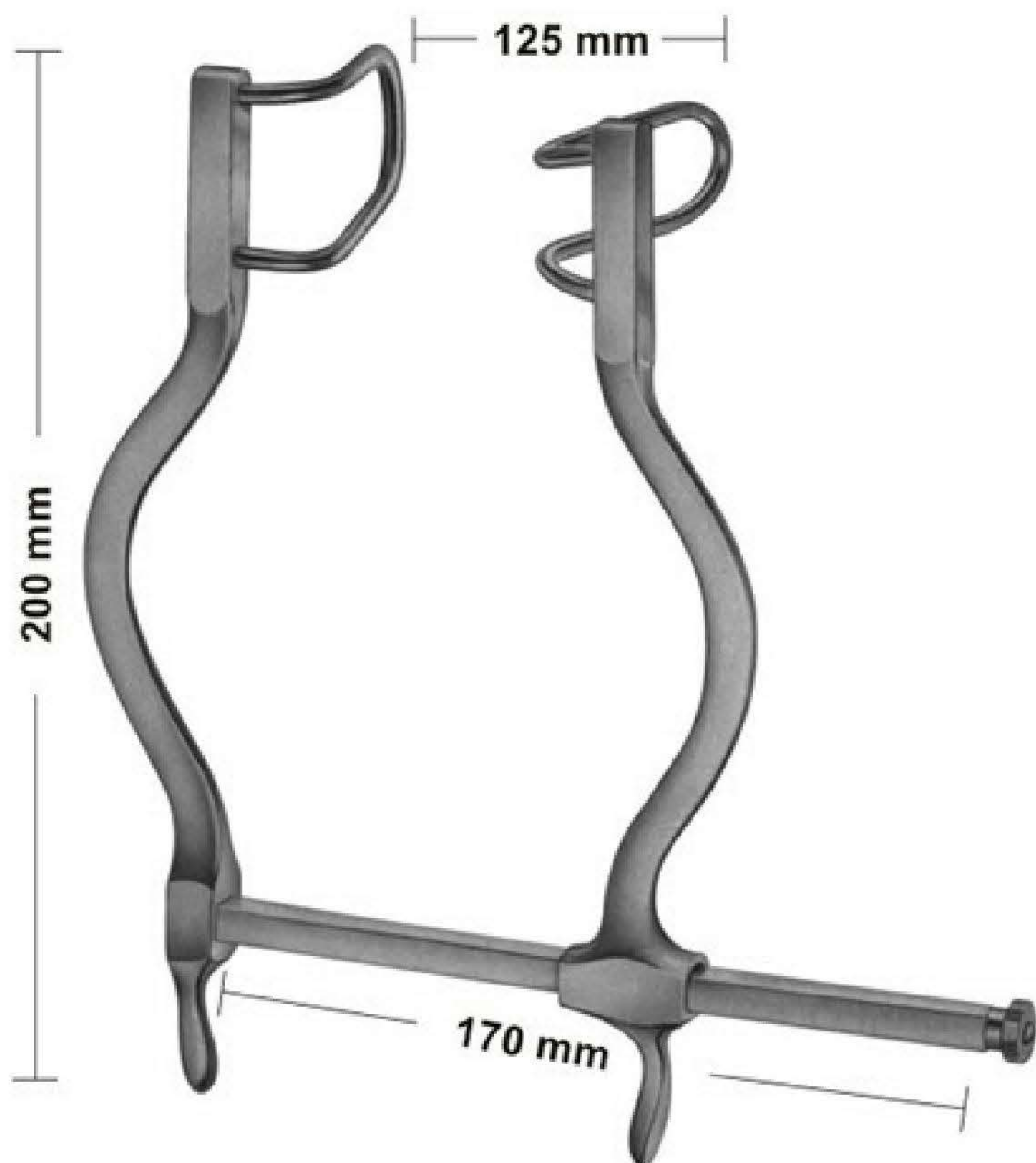

03-5436
GOSSET
 Blades:55mm deep

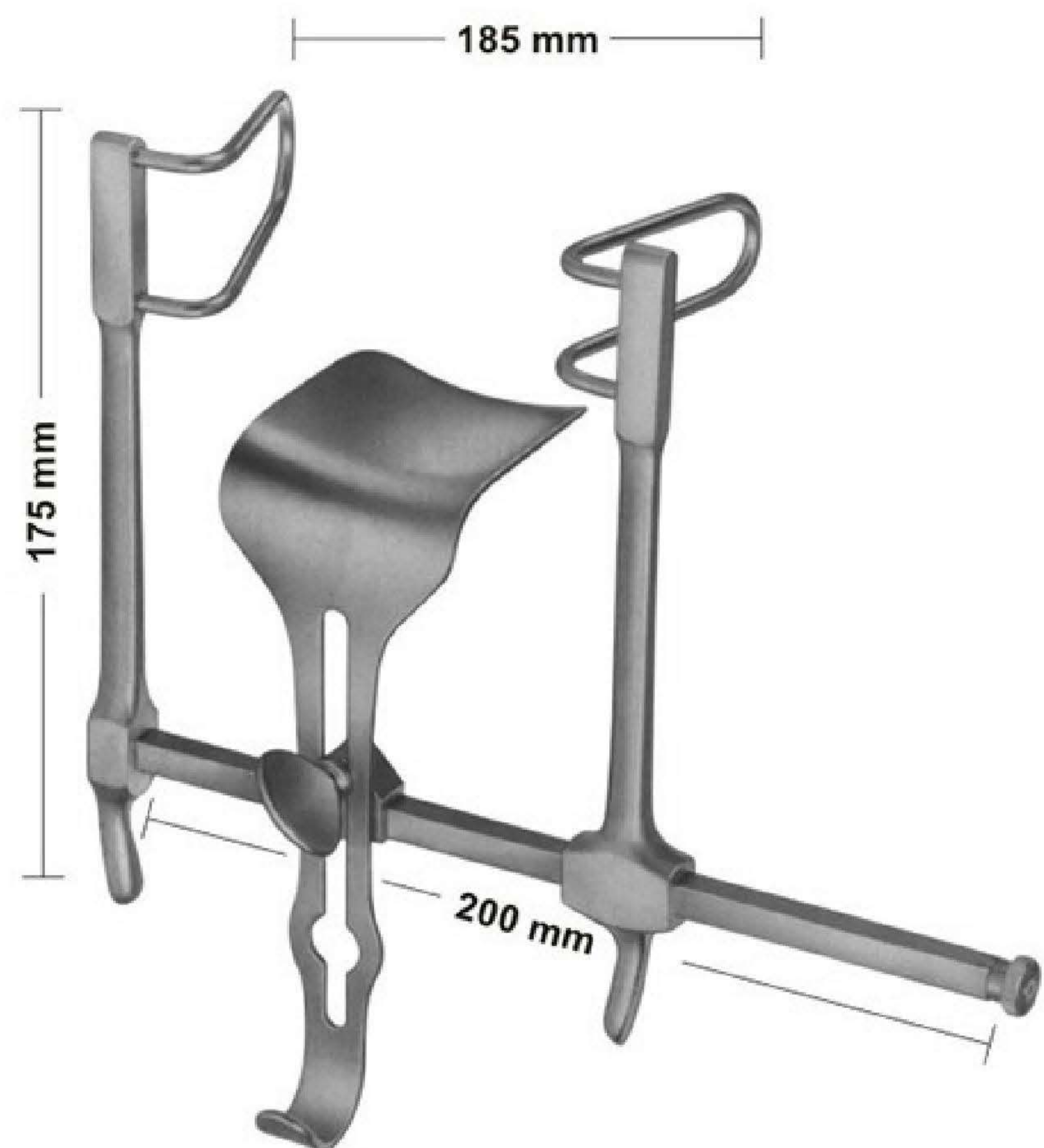

03-5437
GOSSET
 Lateral blades 58 mm deep
 Center blade
 59 x 57 mm

Abdominal Retractors

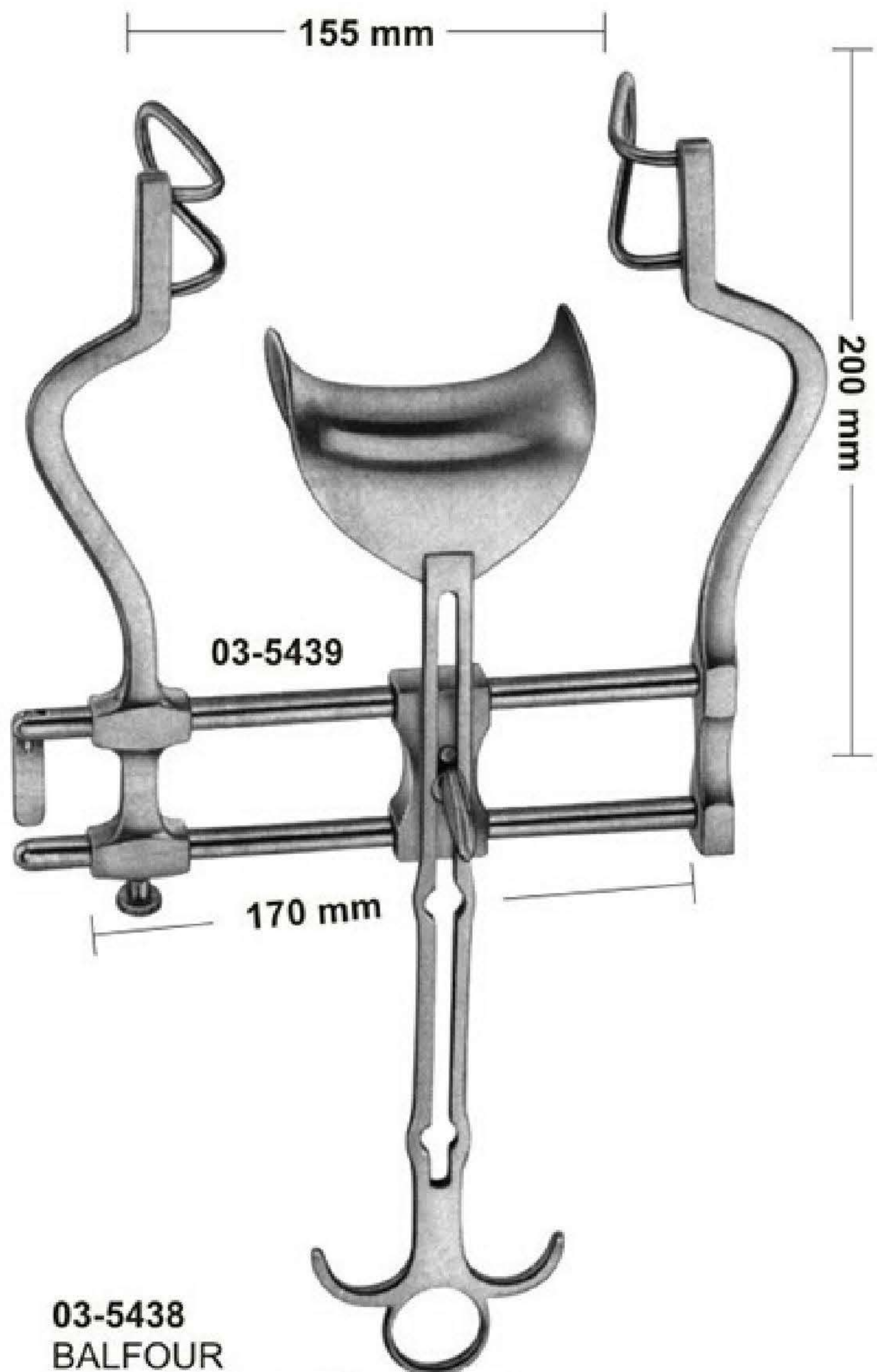

03-5438
BALFOUR
Lateral blades 60 mm deep
(03-5439) Center blade
47 x 80 mm

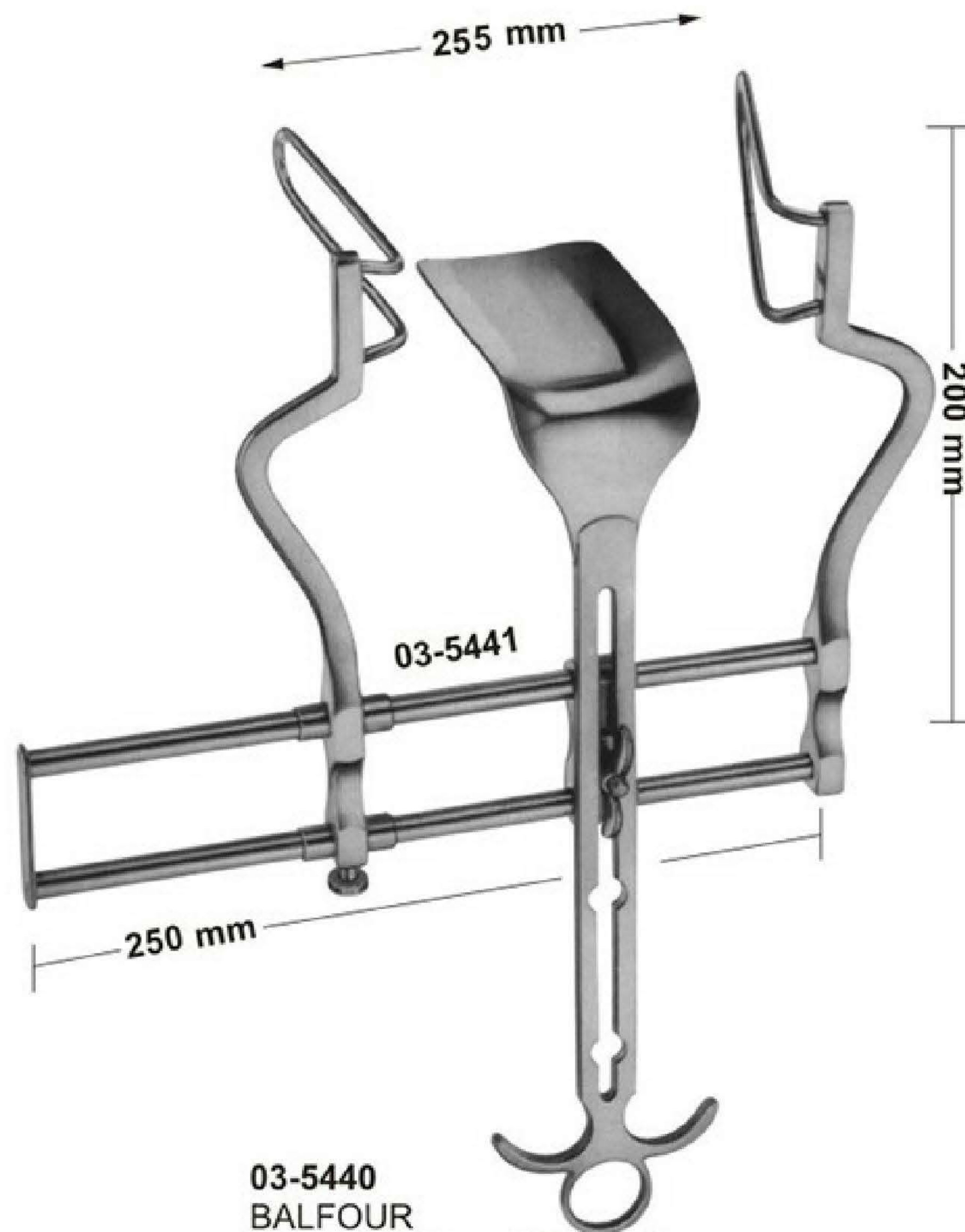

03-5440
BALFOUR
Lateral blades 105 mm deep
(03-5441) Center blade
107x 59 mm

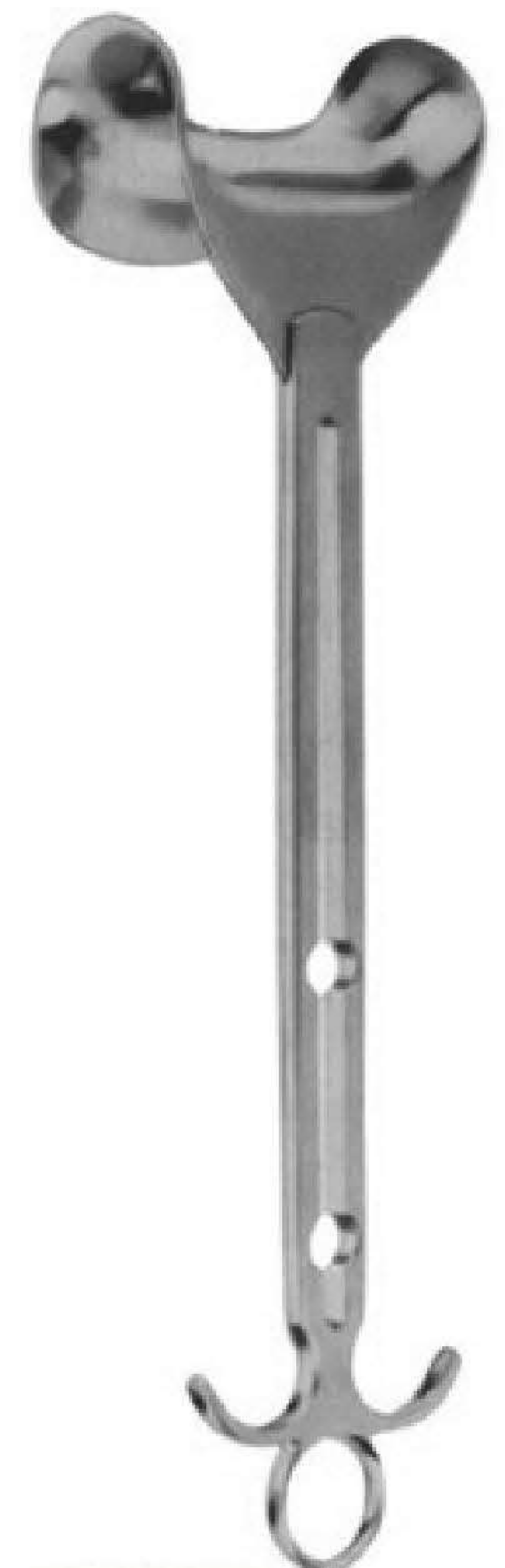

03-5442
Center blade only
54x80 mm

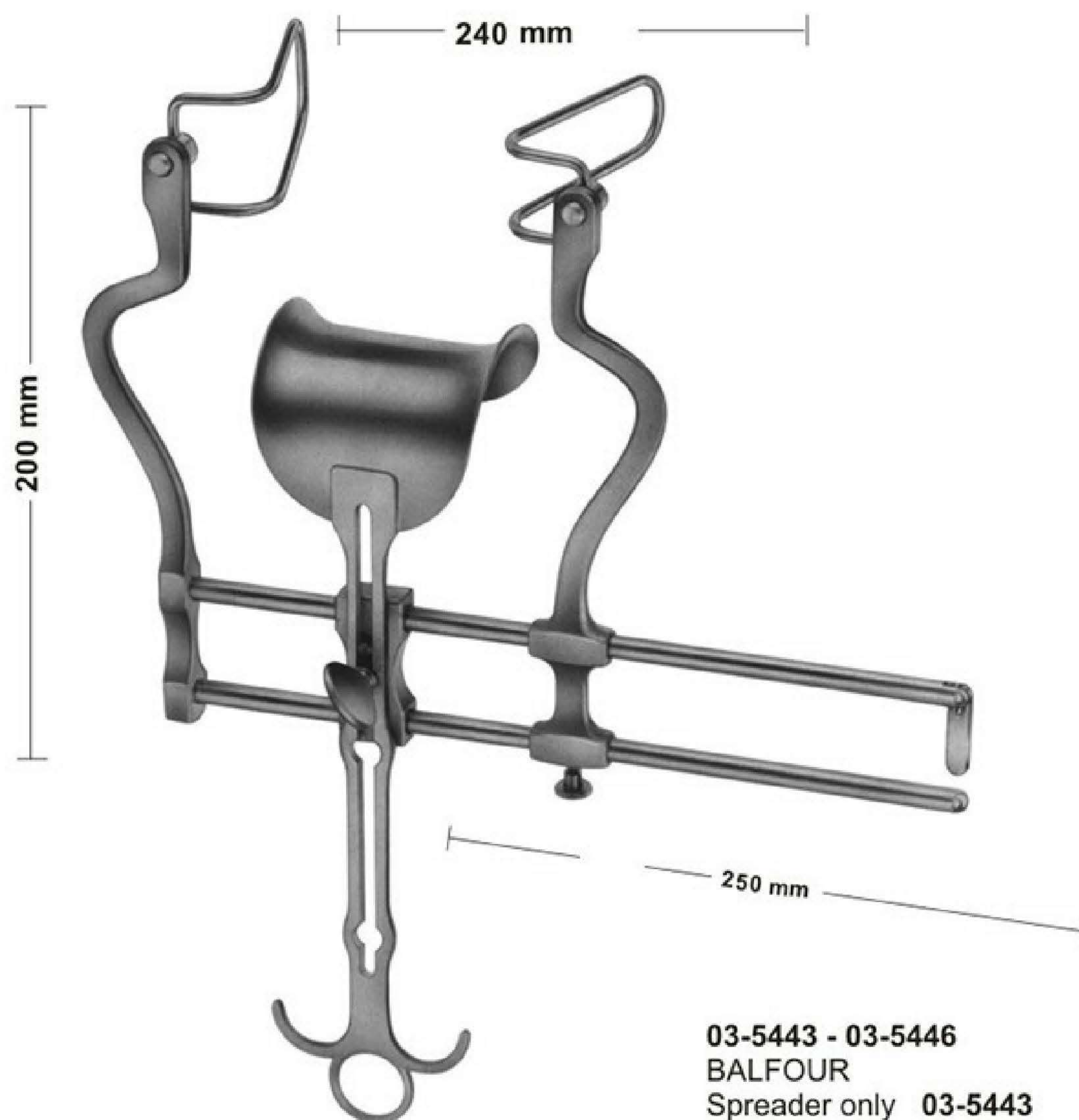

03-5443 - 03-5446
BALFOUR
Spreader only 03-5443 03-5444 03-5445 03-5446
Lateral blades 50 mm 60 mm 75 mm 90 mm
Center blade 47 x 80 mm 62x76 mm 80x80 mm 80x80 mm



Sales Unit of blades: PR = pair

Lateral blades
03-5447
50 mm deep
03-5448
60 mm deep
03-5449
75 mm deep
03-5450
90 mm deep

Abdominal Retractors

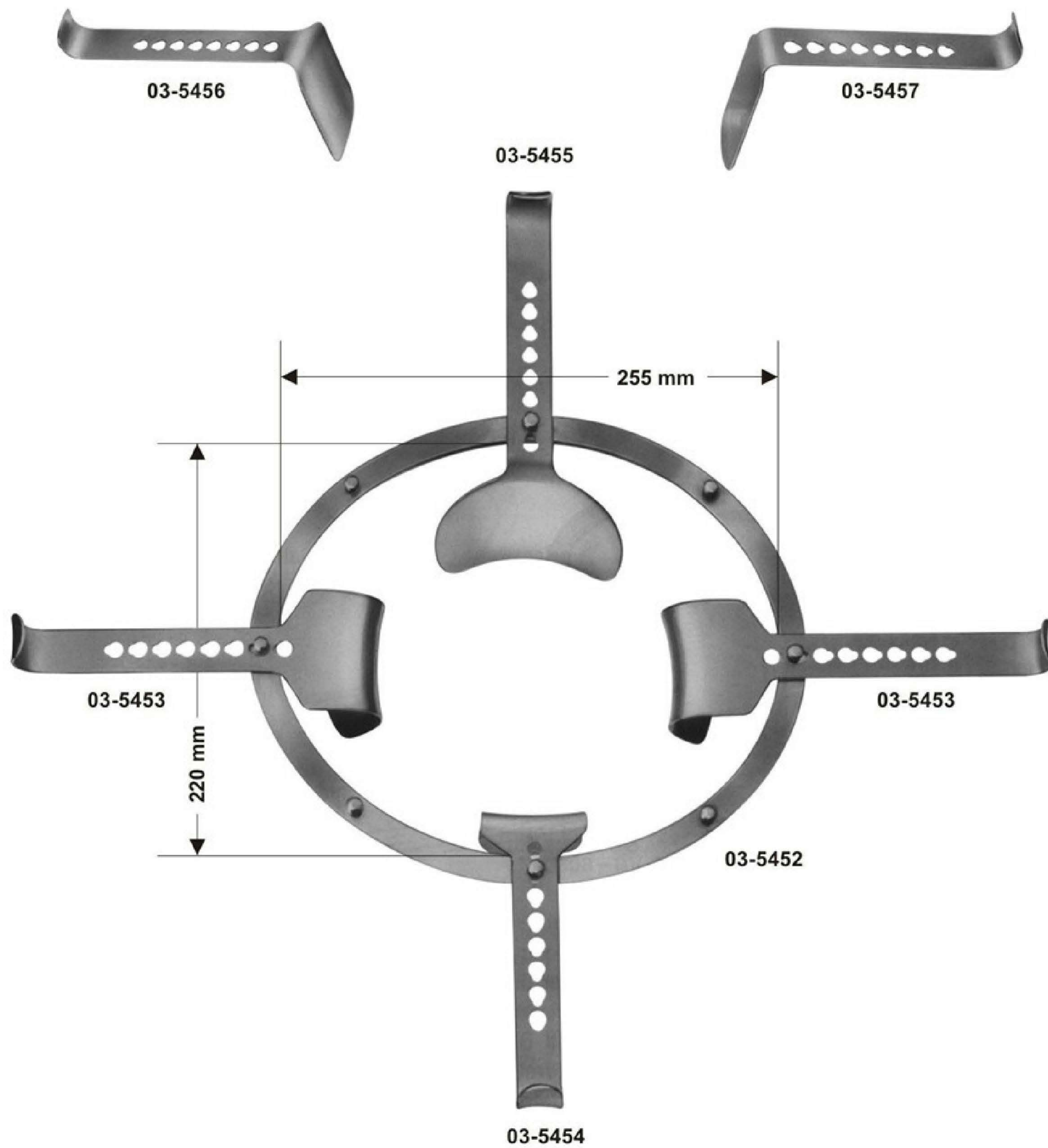

03-5451
SEMM

consisting of:

03-5452 1 frame 225 x 220 mm

03-5453 2 blades 46 x 64 mm

03-5454 1 blade 53 x 54 mm
(for bladder)

03-5455 1 blade 82 x 97 mm
(for intestine)

03-5456 1 blade 98 x 51 mm
(for intestine)

03-5457 1 blade, narrow
107 x 36 mm

Abdominal Retractors

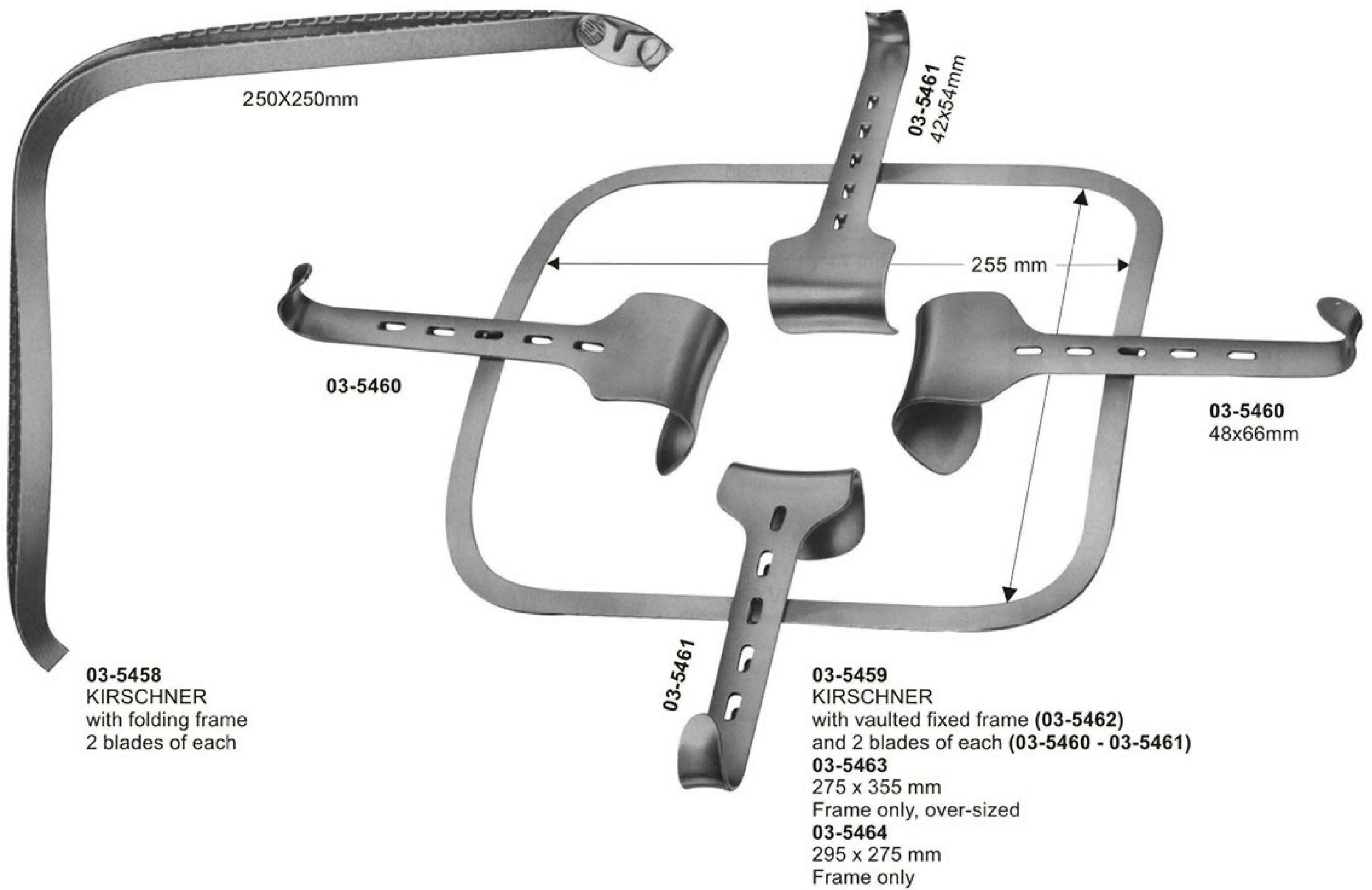

03-5458
KIRSCHNER
with folding frame
2 blades of each

03-5459
KIRSCHNER
with vaulted fixed frame (03-5462)
and 2 blades of each (03-5460 - 03-5461)
03-5463
275 x 355 mm
Frame only, over-sized
03-5464
295 x 275 mm
Frame only



03-5465
KIRSCHNER
64 x 80 mm



03-5466
KIRSCHNER-BALFOUR
80x 82 mm



03-5467 - 03-5469
KIRSCHNER
03-5467 90x 69mm
03-5468 92x 95mm
03-5469 78x 58mm



03-5470 - 03-5472
KIRSCHNER
03-5470 108x42mm
03-5471 91x 55mm
03-5472 121x 55mm

Addition valves for corpulent persons.