

Mallets Weight Refer To The Heads Of The Mallets



∅ 20 mm

½

06-8271
 MEAD
 185 g
 with interchangeable
 plastic disks
 190 mm
06-8272
 pair of spare disks



∅ 25 mm

½

06-8273
 140 g
 with interchangeable
 plastic disks
 185 mm
06-8274
 pair of spare disks



∅ 30 mm

½

06-8275
 COTTLE
 240 g
 1 Side flat
 1 Side convex
 185 mm



∅ 22 mm

½

06-8276
 165 g
 lead filled head
 190 mm

Mallets, Weights Refer To The Heads Of The Mallets



06-8277
 HAJEK
 140 g
 220 mm



06-8278
 215 g
 with interchangeable
 plastic disks
 245 mm
06-8279
 pair of spare disks

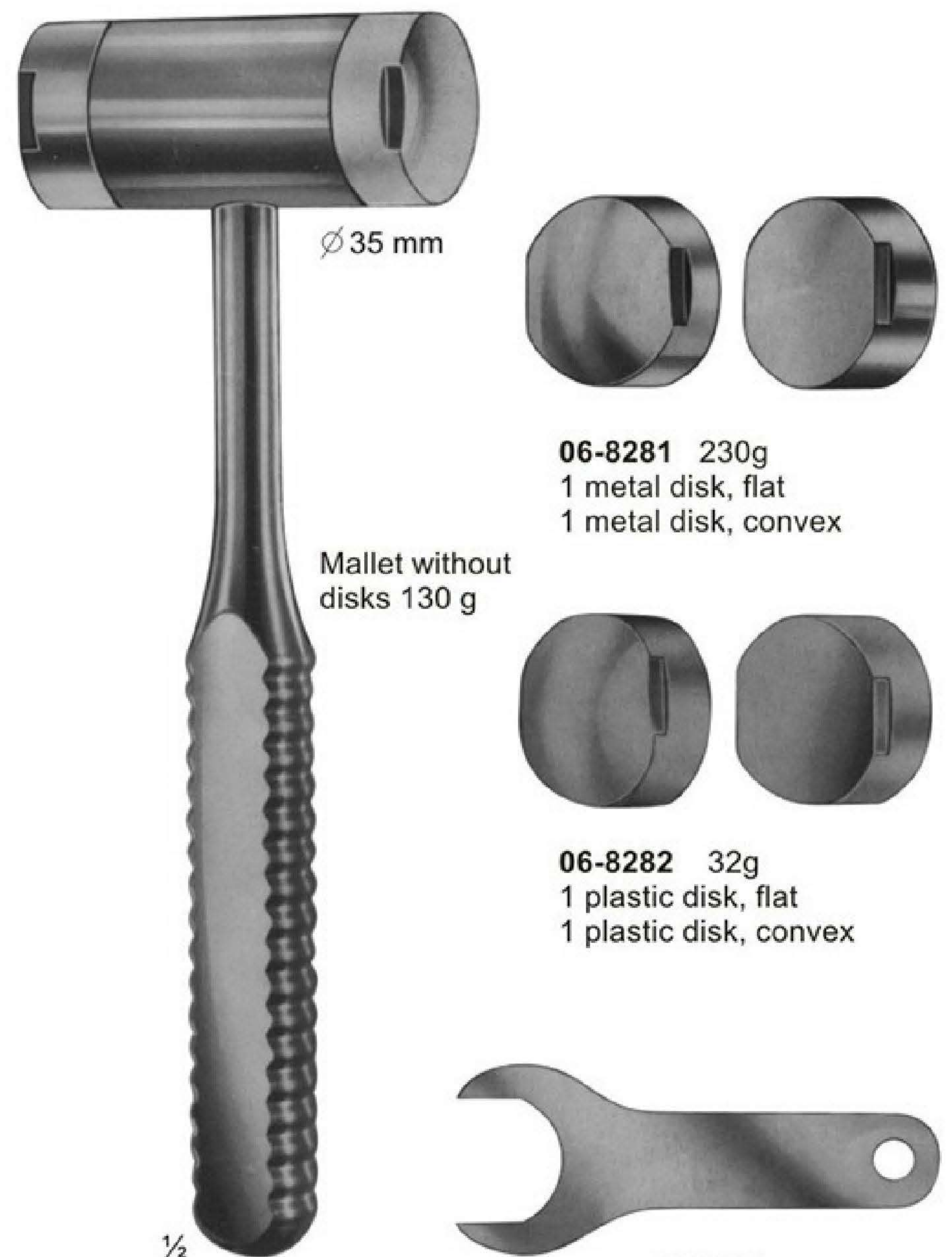

06-8280 - 06-8283
 WAGNER
 complete with:
 1 pair of metal disks (**06-8281**) and
 1 pair of plastic disks (**06-8282**) and
 1 wrench (**06-8283**)
 235 mm

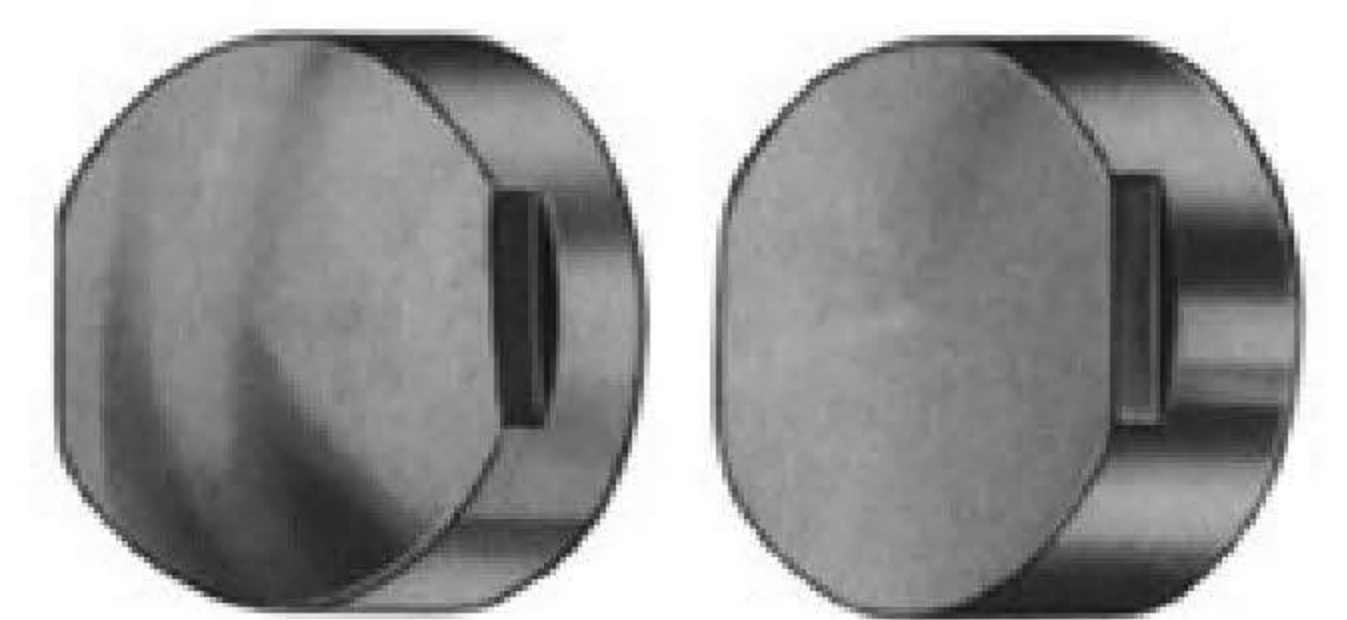

06-8281 230g
 1 metal disk, flat
 1 metal disk, convex

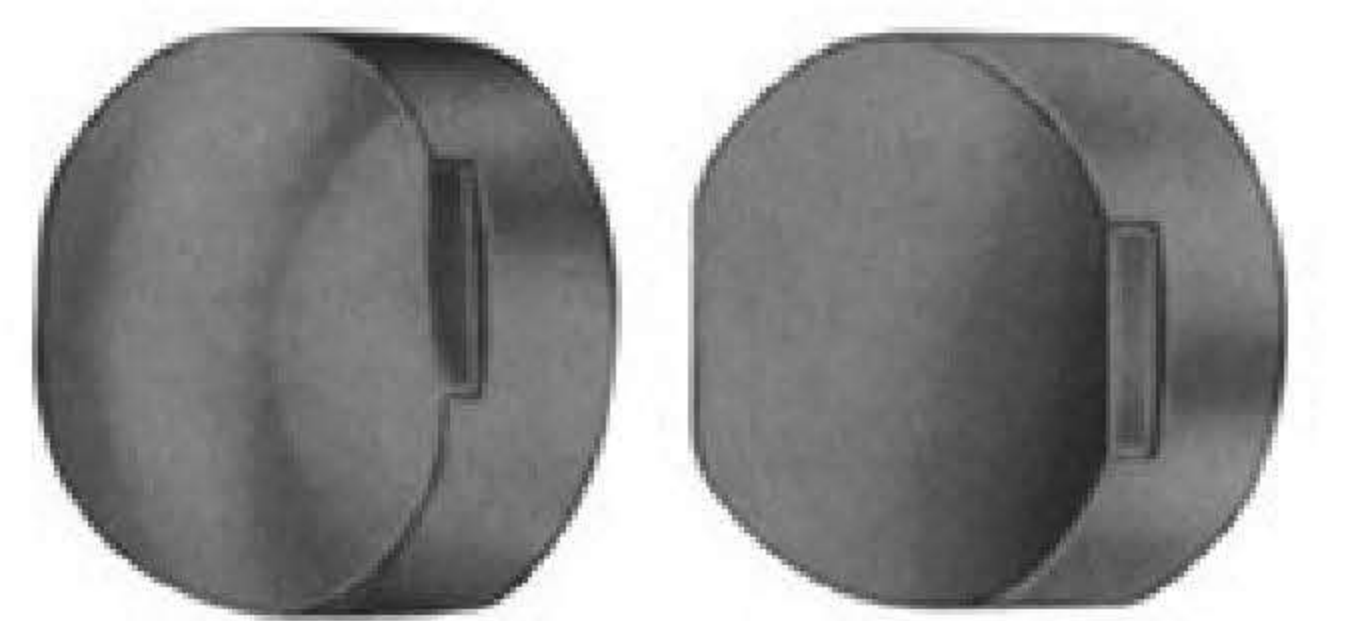

06-8282 32g
 1 plastic disk, flat
 1 plastic disk, convex

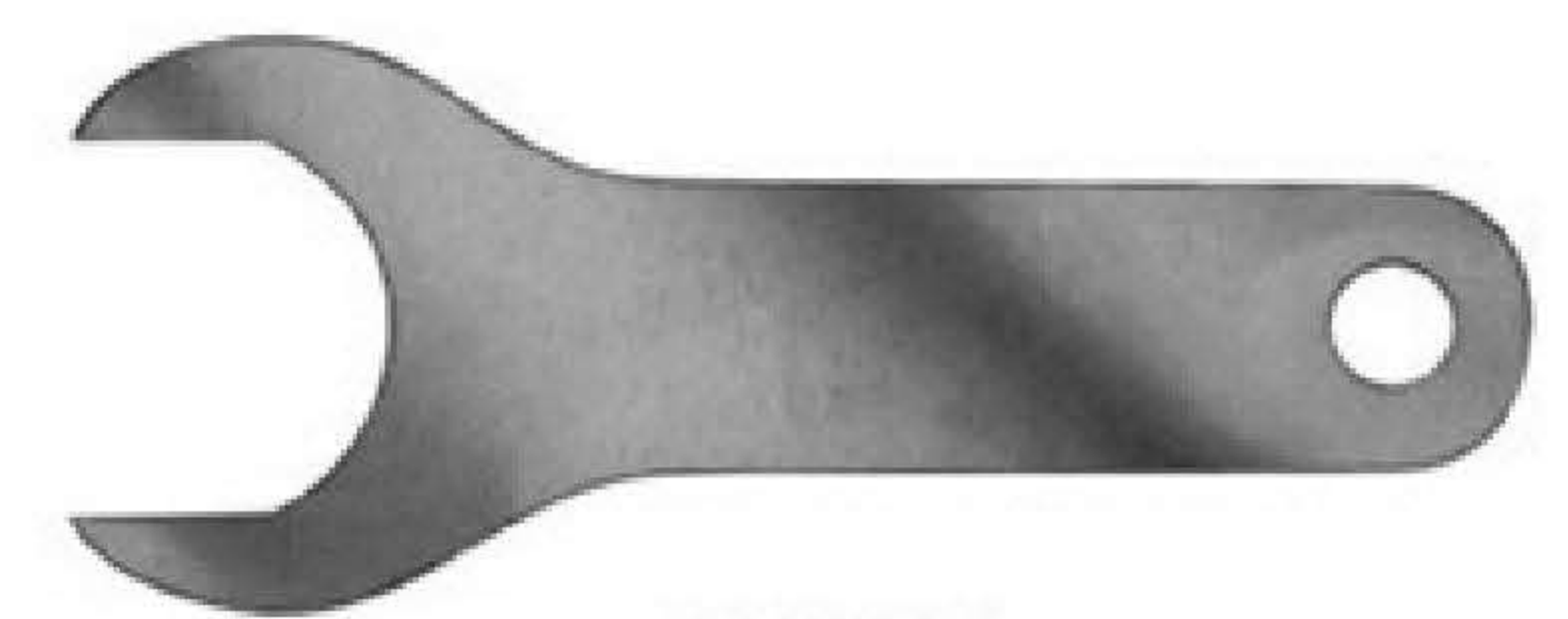

06-8283
 Wrench

Mallet without
 disks 130 g

Mallets Weight Refer To The Heads Of The Mallets



06-8284 300g
 BERGMANN
 245 mm



06-8285 300g
 BERGMANN
 235 mm



06-8286 550g
 OMBREDANNE
 240 mm



06-8287
 HEATH
 copper filled head
 700 g
 185 mm

Tampers - Osteotomes, Chisels and Gouges

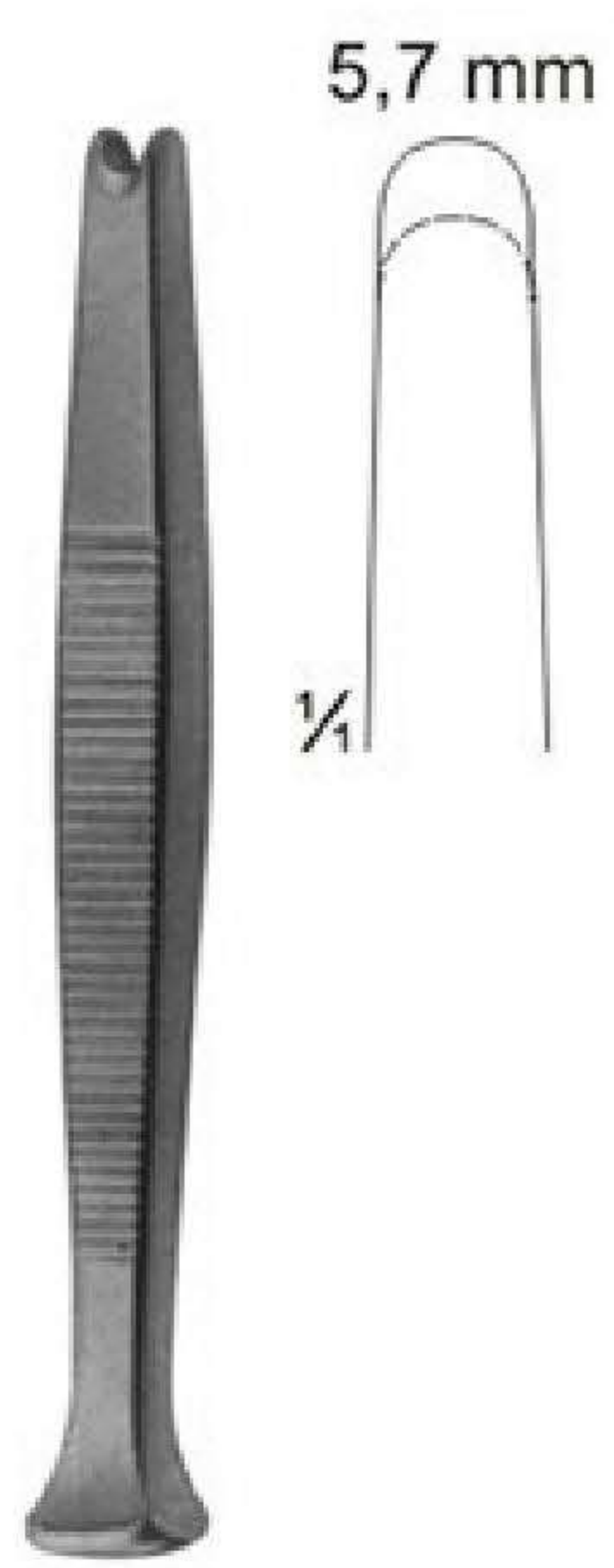

06-8288
HAASE
100 mm



06-8289 - 06-8290
PASSOW
120 mm



06-8291 - 06-8293
CASPAR
200 mm

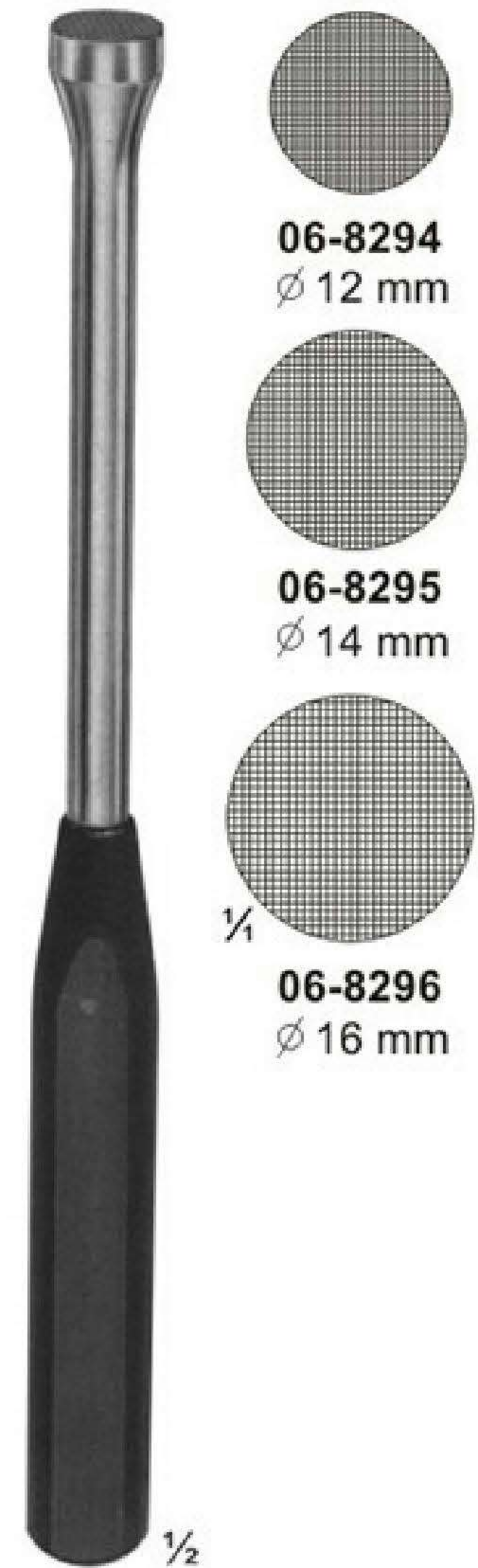

06-8294 - 06-8296
200 mm

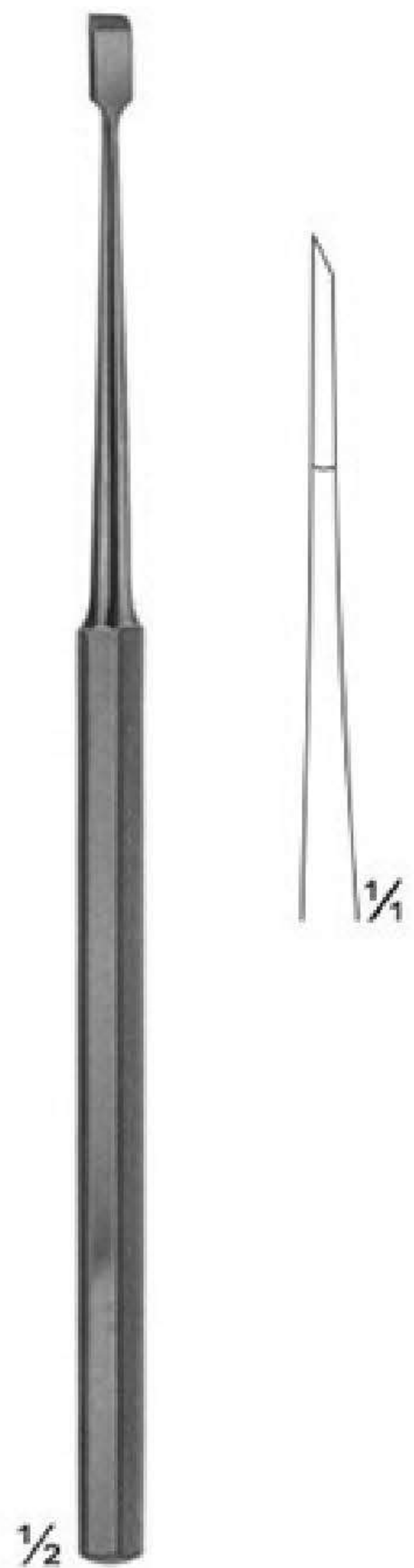

06-8297 4mm
FREER
Chisel
160 mm

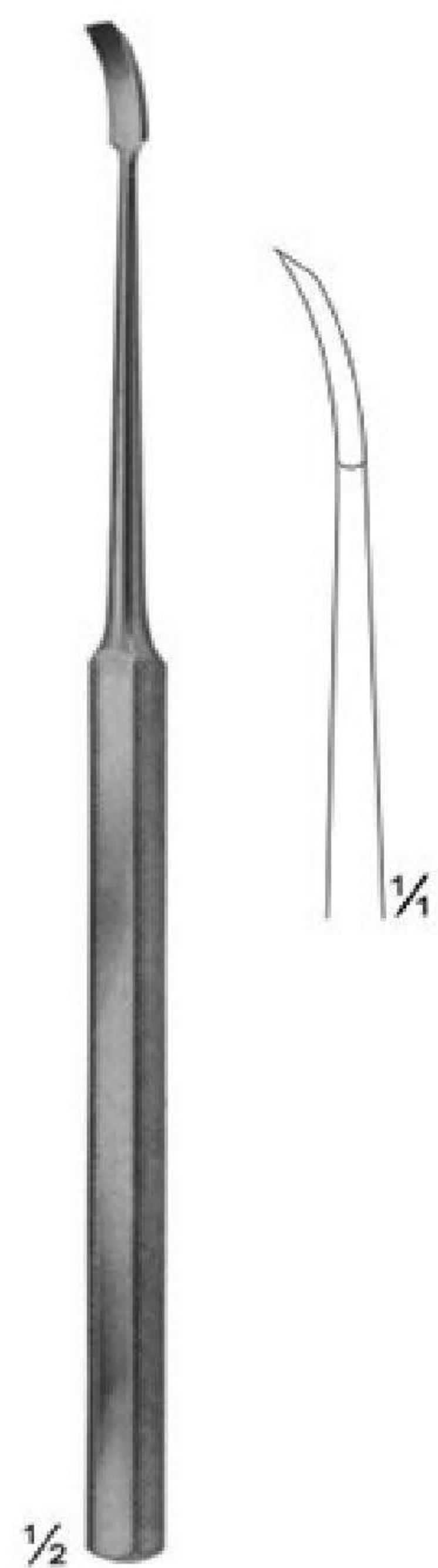

06-8298 4mm
FREER
Chisel, curved
160 mm

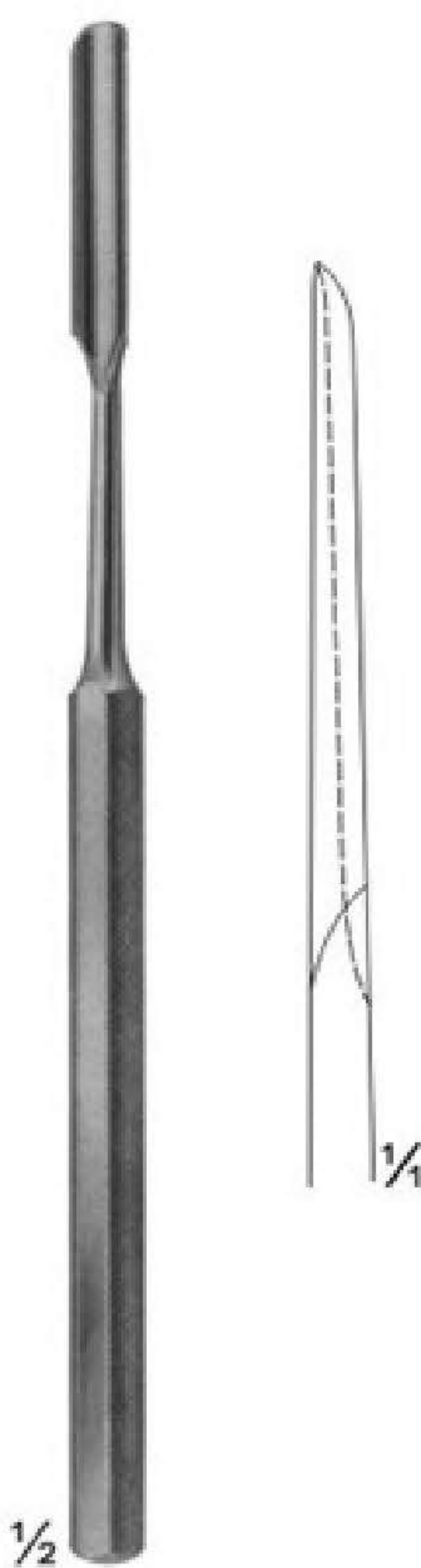

06-8299 6mm
FREER
Gouge
150 mm

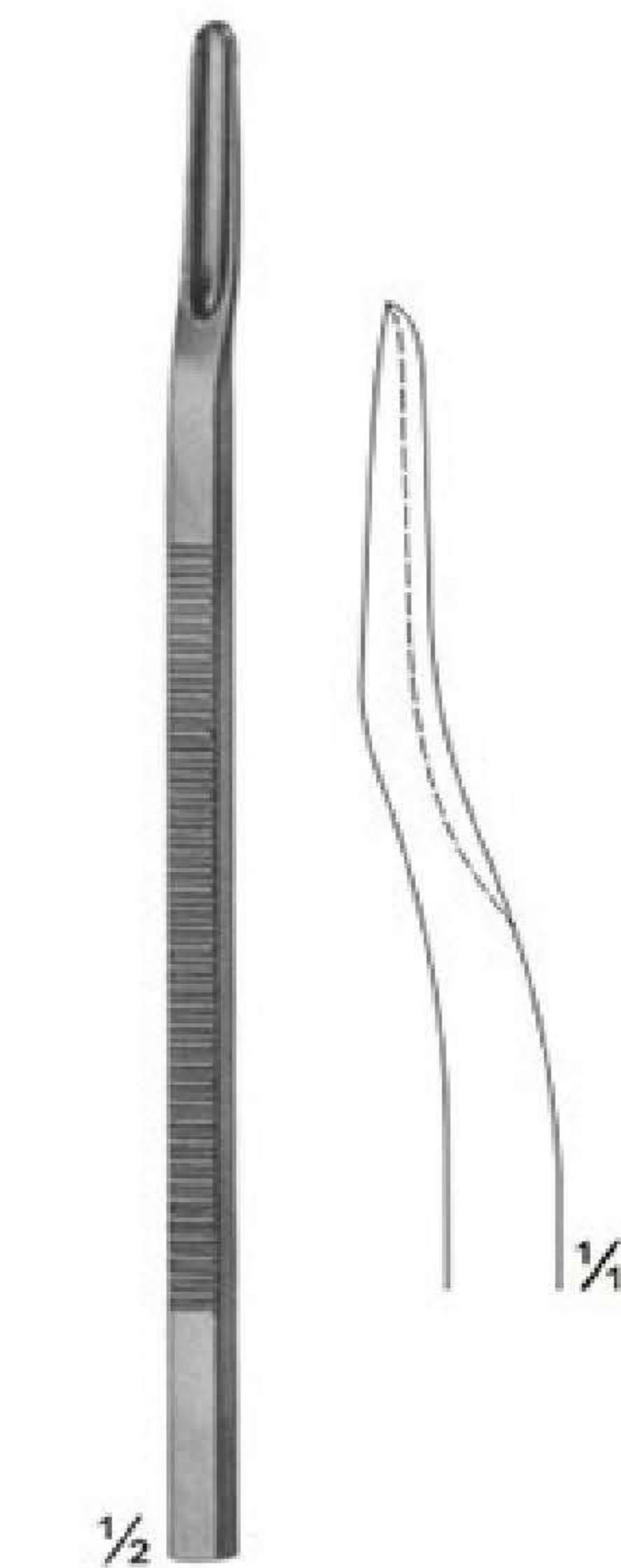

06-8300 3.4mm
Scaphoid gouge,
downwards curved
135 mm

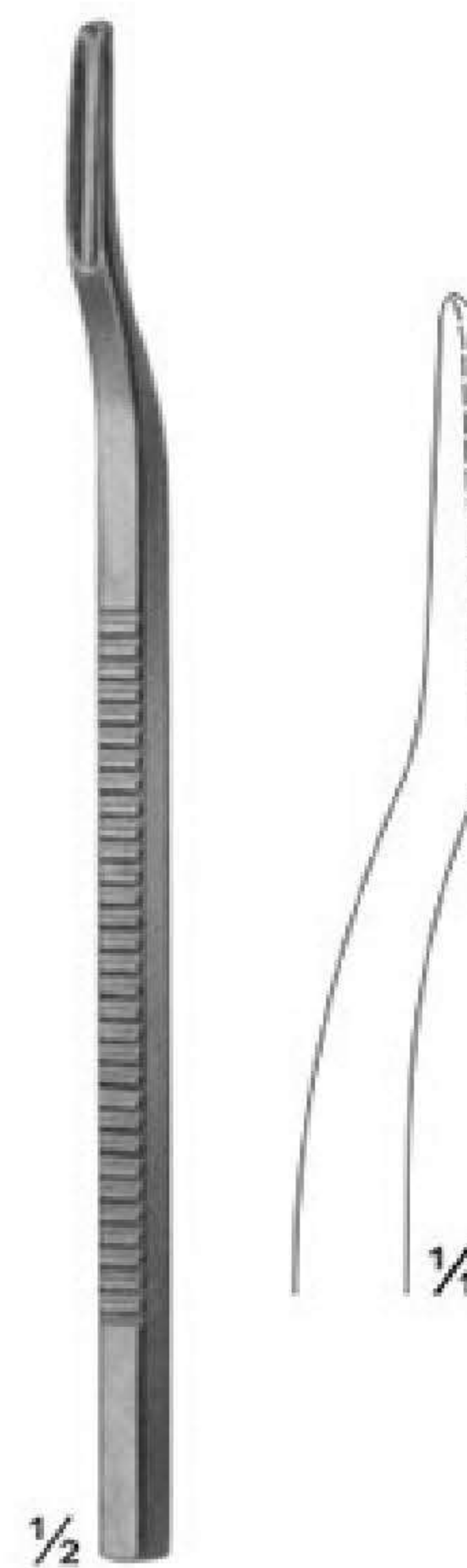

06-8301 3.4mm
Scaphoid gouge,
upwards curved
135 mm

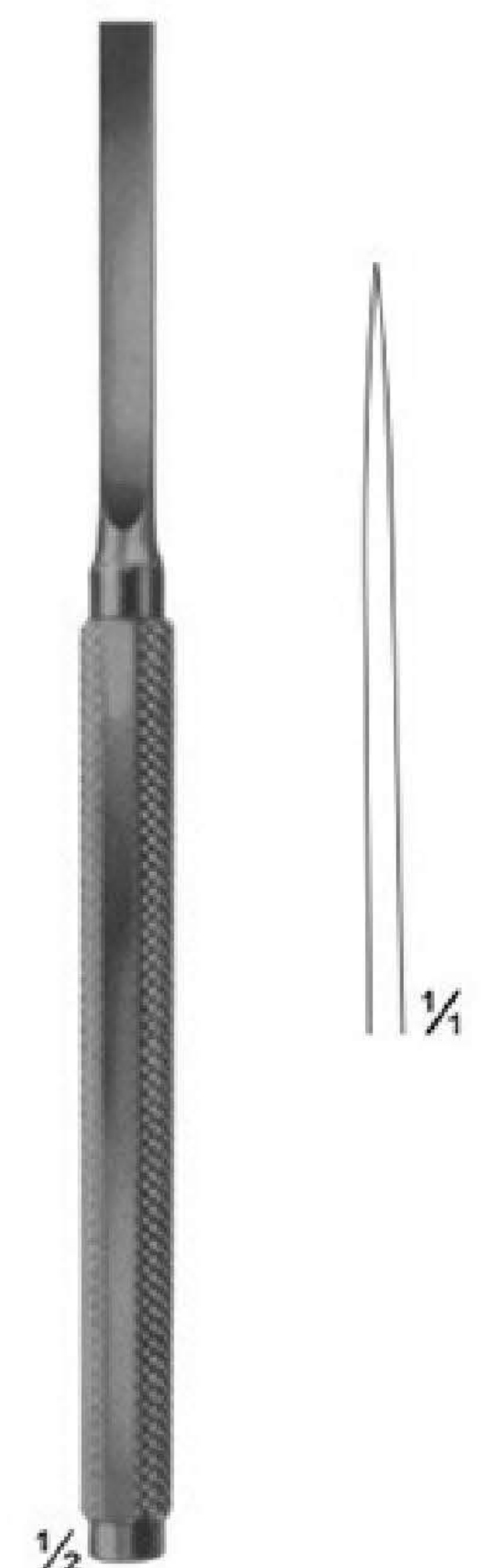

06-8302 - 06-8304
MANNERFELT modif
Osteotomes
06-8302 4 mm
06-8303 6 mm
06-8304 8 mm
155 mm

Osteotomes Chisels and Gouges

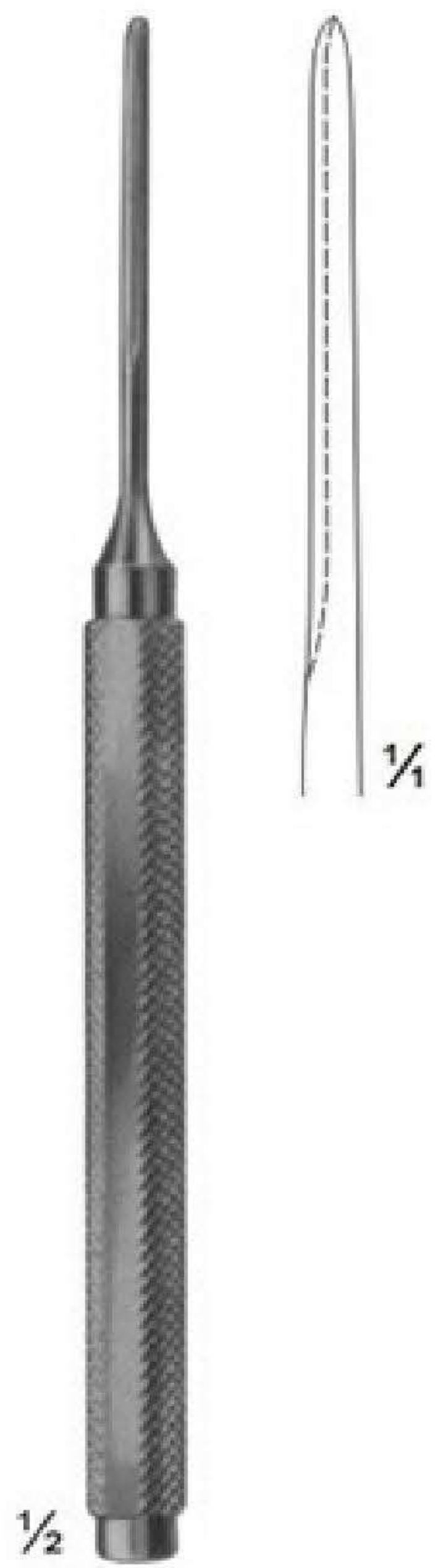

06-8305 3mm
MANNERFELT modif.
Gouge
155 mm

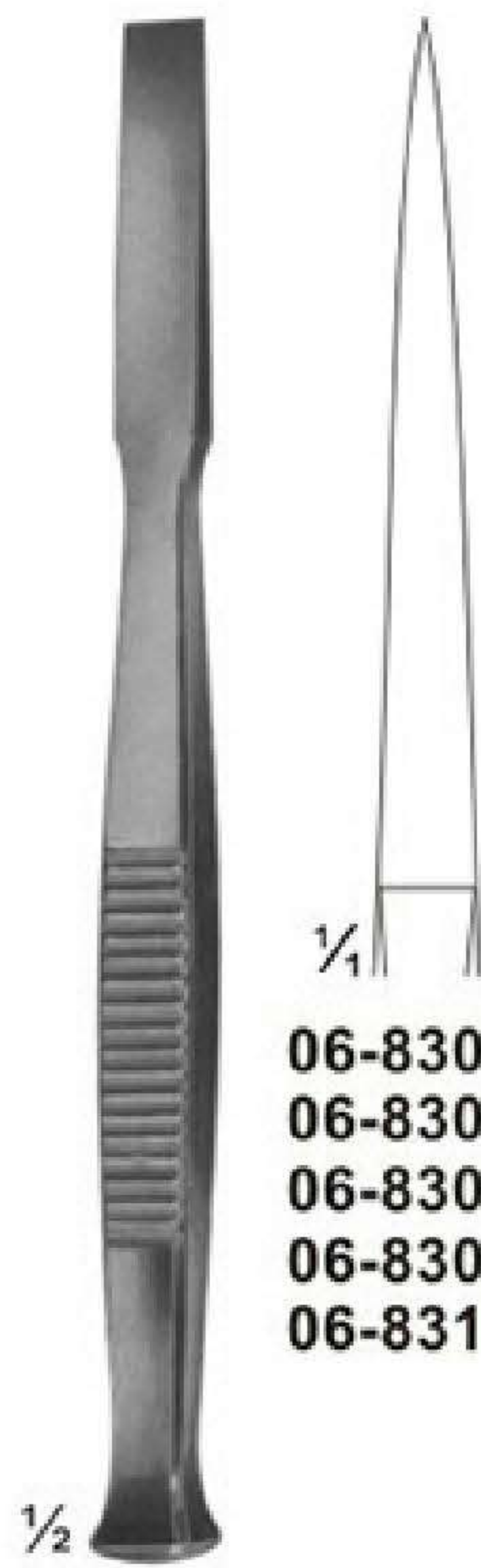

06-8306 - 06-8310
Osteotomes
140 mm

- 06-8306** 4 mm
- 06-8307** 6 mm
- 06-8308** 8 mm
- 06-8309** 10 mm
- 06-8310** 12 mm

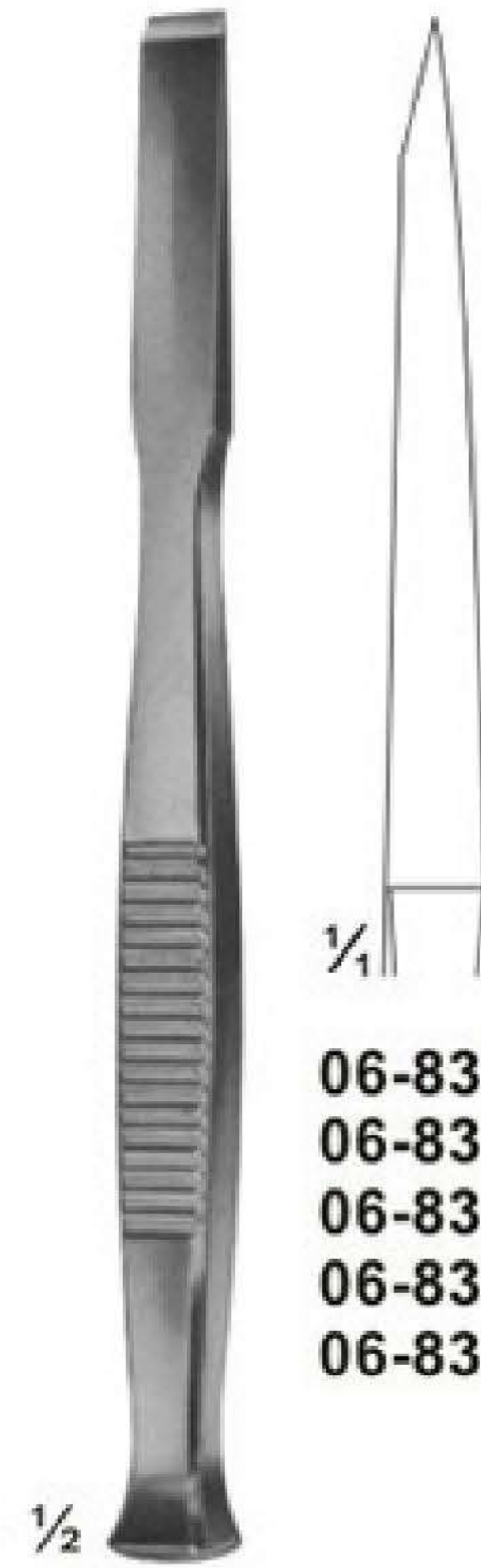

06-8311 - 06-8315
Chisels
140 mm

- 06-8311** 4 mm
- 06-8312** 6 mm
- 06-8313** 8 mm
- 06-8314** 10 mm
- 06-8315** 12 mm

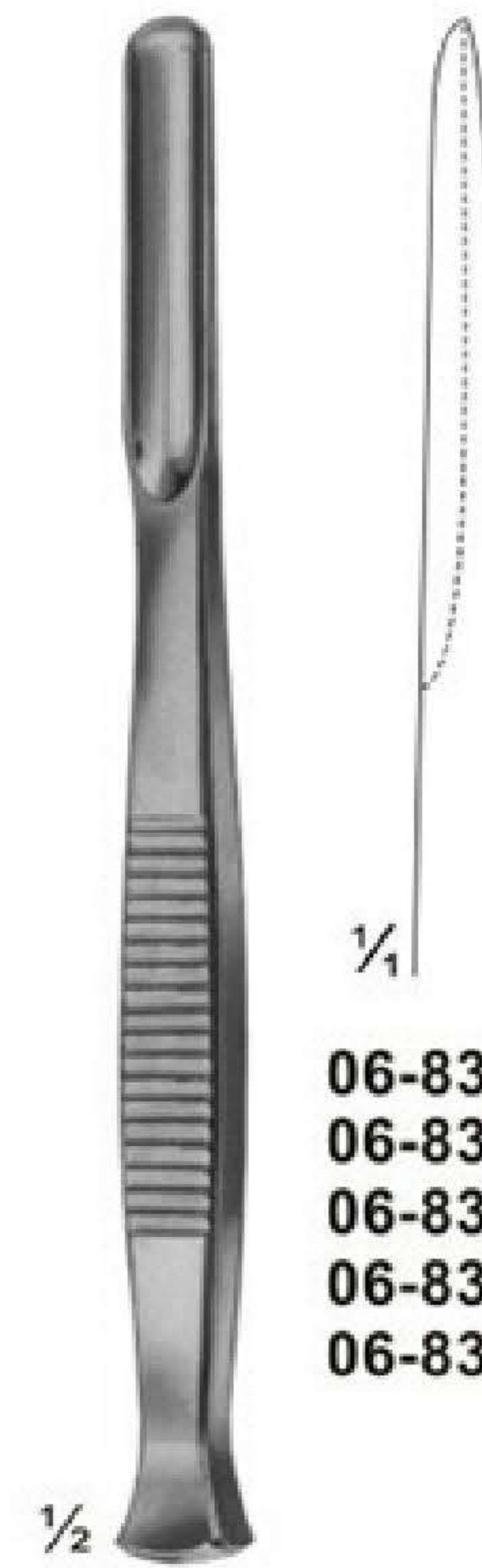

06-8316 - 06-8320
Gouges
140 mm

- 06-8316** 4 mm
- 06-8317** 6 mm
- 06-8318** 8 mm
- 06-8319** 10 mm
- 06-8320** 12 mm

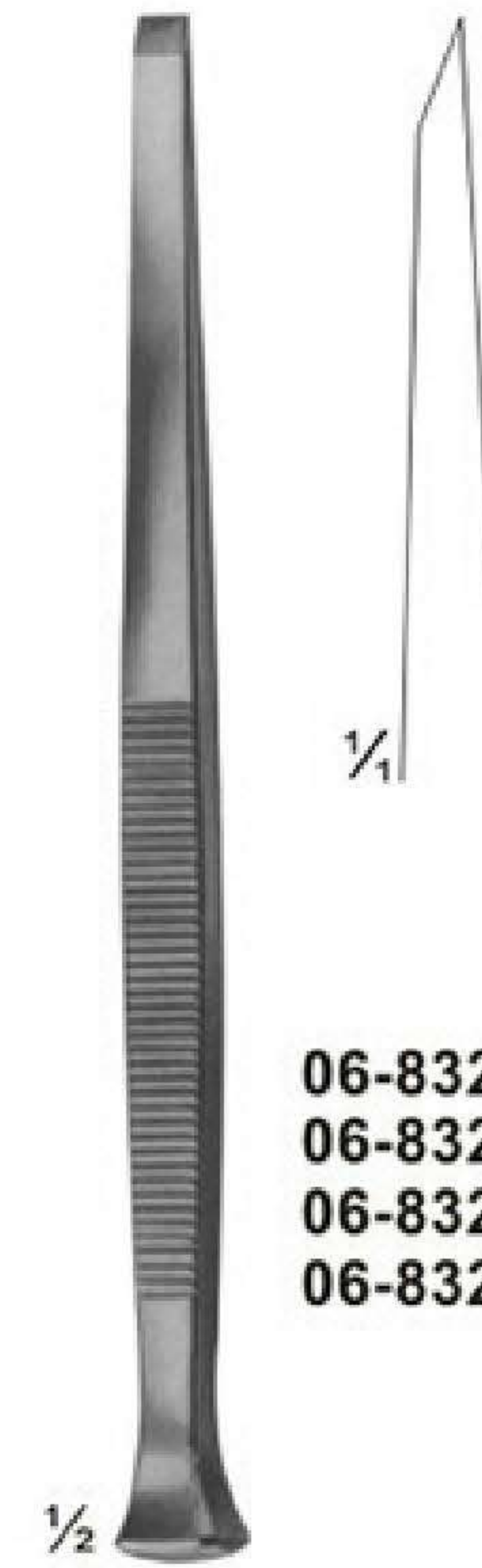

PARTSCH
06-8321 - 06-8324
Chisels
140 mm

- 06-8321** 3 mm
- 06-8322** 4 mm
- 06-8323** 5 mm
- 06-8324** 6 mm

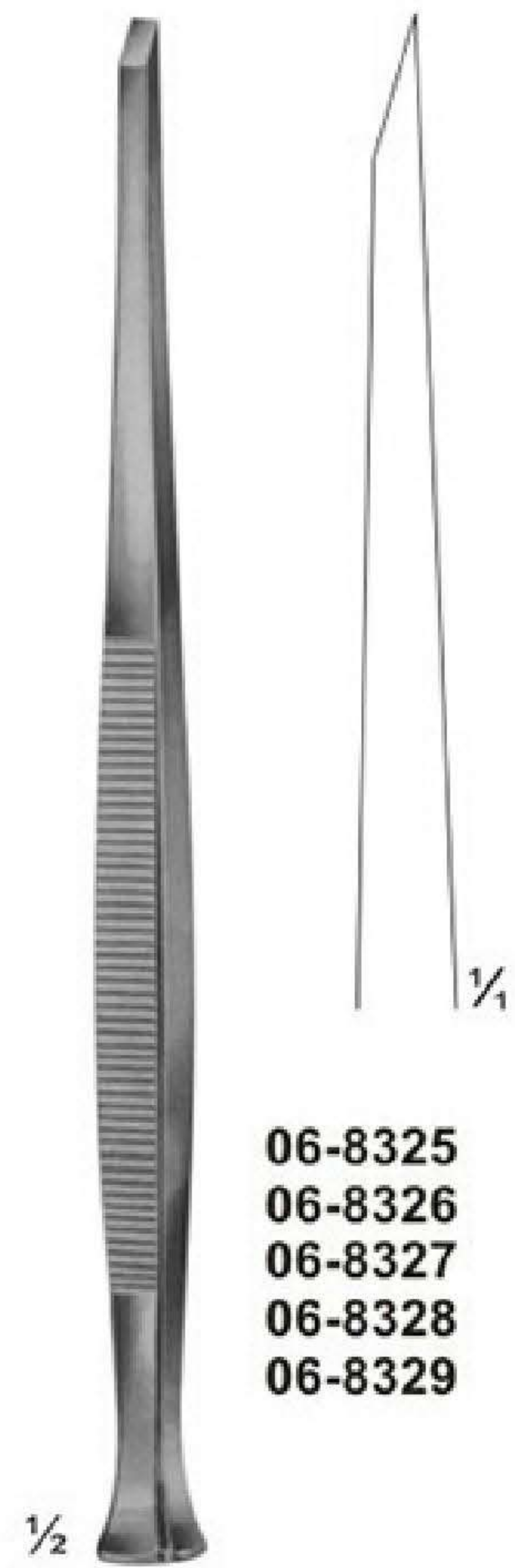

PARTSCH
06-8325 - 06-8329
Chisels
170 mm

- 06-8325** 3 mm
- 06-8326** 4 mm
- 06-8327** 5 mm
- 06-8328** 6 mm
- 06-8329** 7 mm

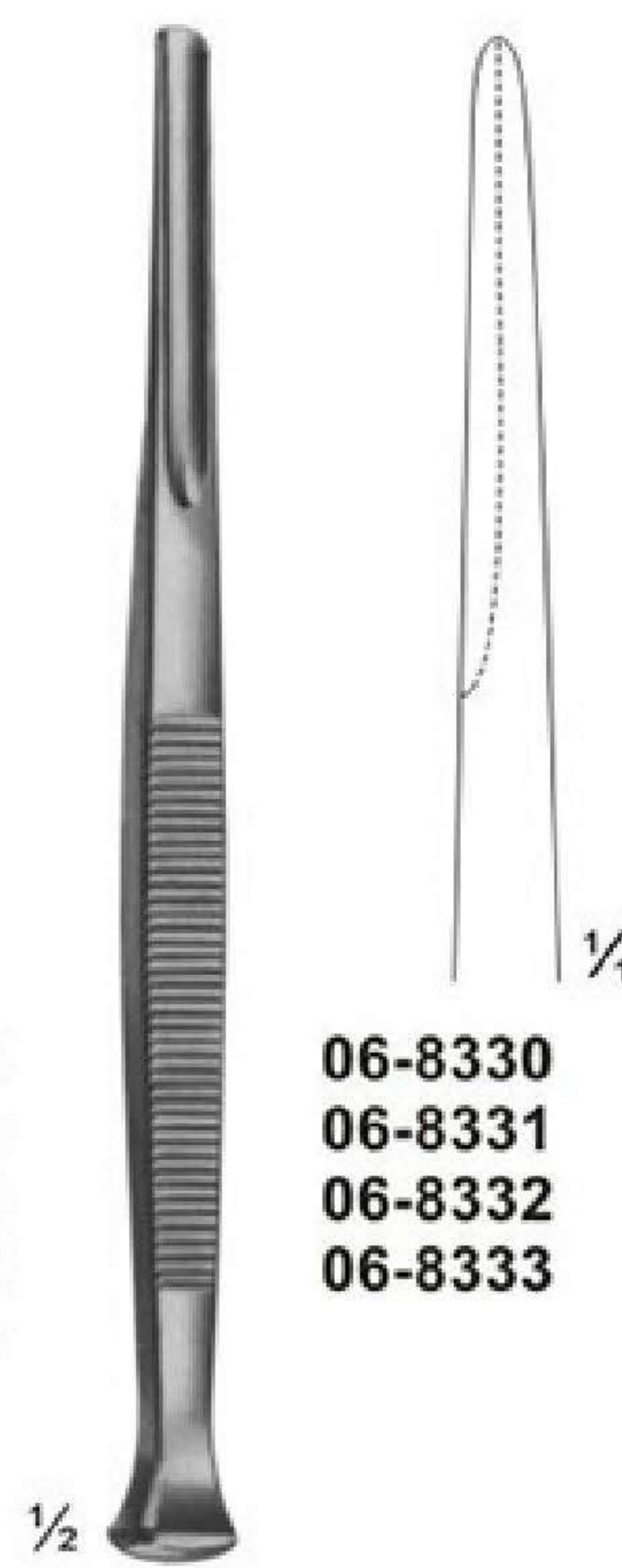

PARTSCH
06-8330 - 06-8333
Gouges
140 mm

- 06-8330** 3 mm
- 06-8331** 4 mm
- 06-8332** 5 mm
- 06-8333** 6 mm

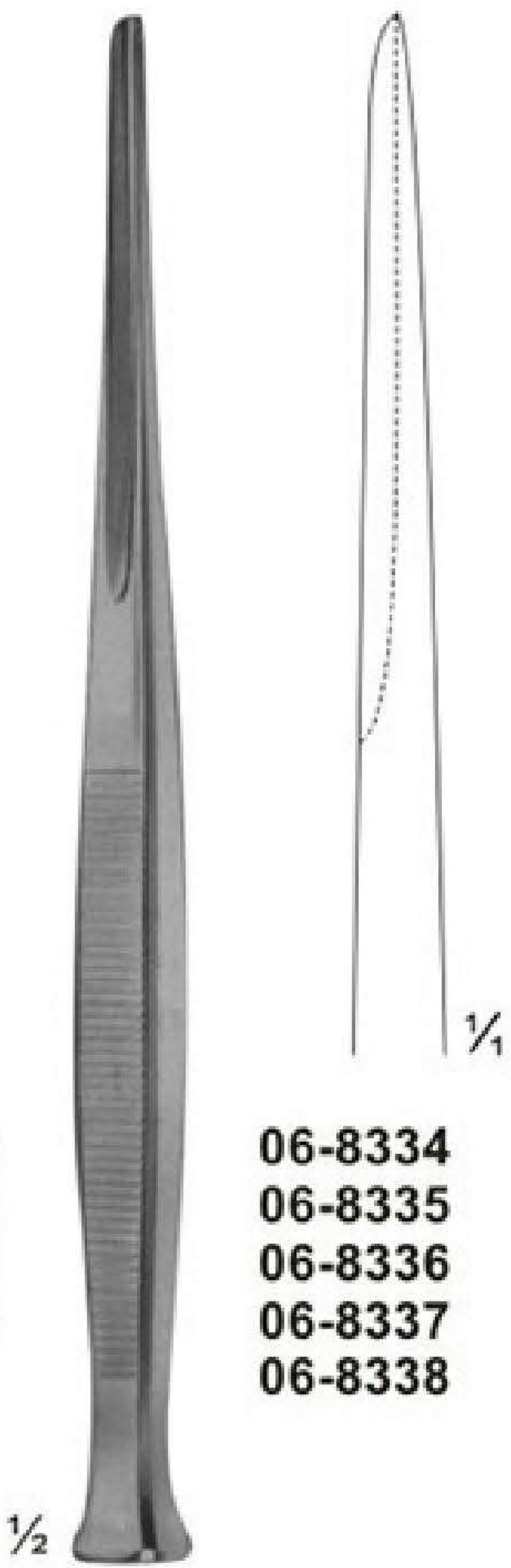

PARTSCH
06-8334 - 06-8338
Gouges
170 mm

- 06-8334** 3 mm
- 06-8335** 4 mm
- 06-8336** 5 mm
- 06-8337** 6 mm
- 06-8338** 7 mm



LUCAS
06-8339 - 06-8340
Chisels
160 mm

- 06-8339** 4 mm
- 06-8340** 6 mm

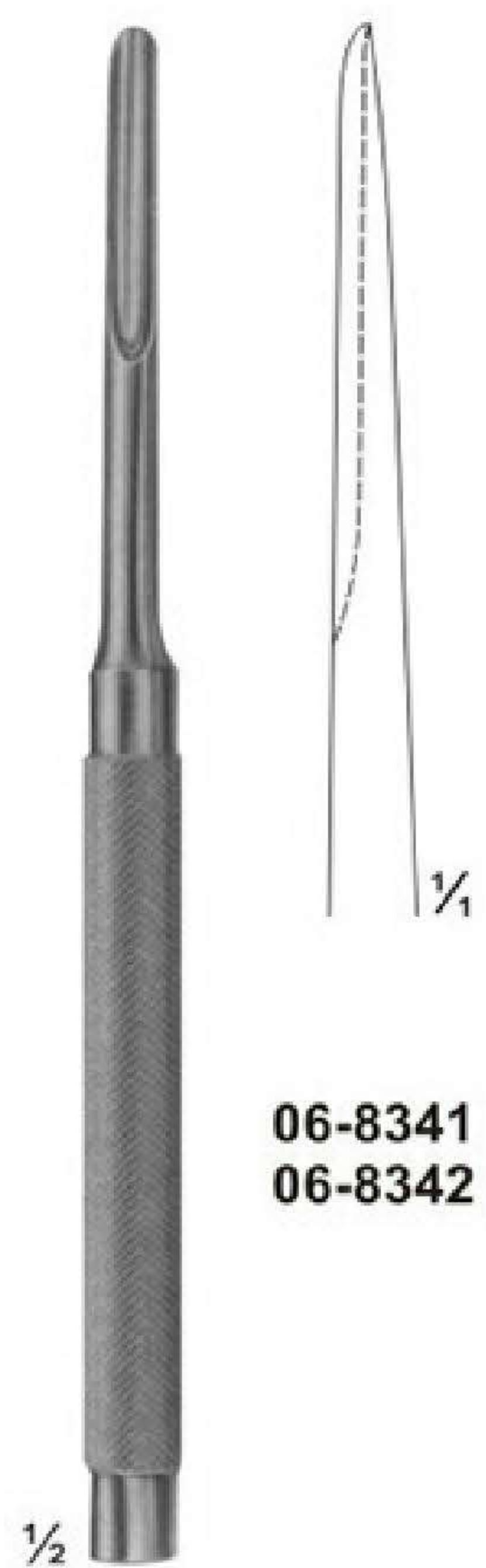

LUCAS
06-8341 - 06-8342
Gouges
160 mm

- 06-8341** 3 mm
- 06-8342** 5 mm

Osteotomes Chisels and Gouges

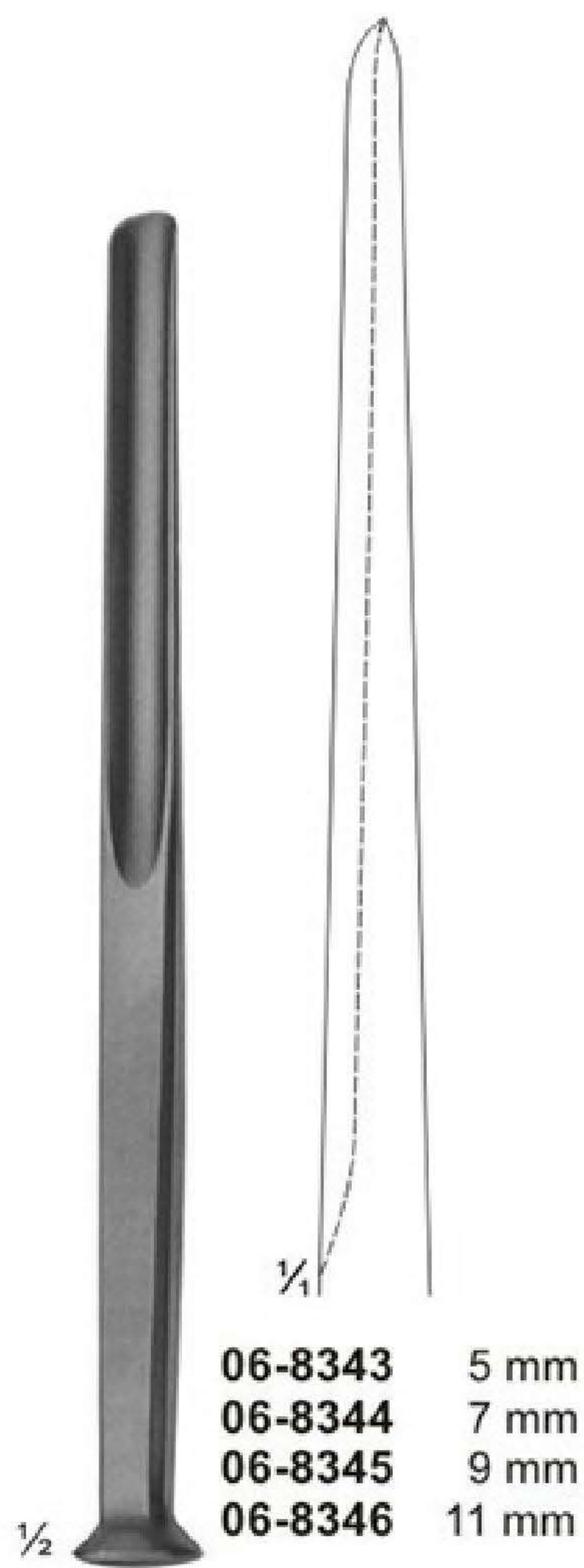

06-8343 5 mm
06-8344 7 mm
06-8345 9 mm
06-8346 11 mm

ALEXANDER
06-8343 - 06-8346
Gouges
170 mm

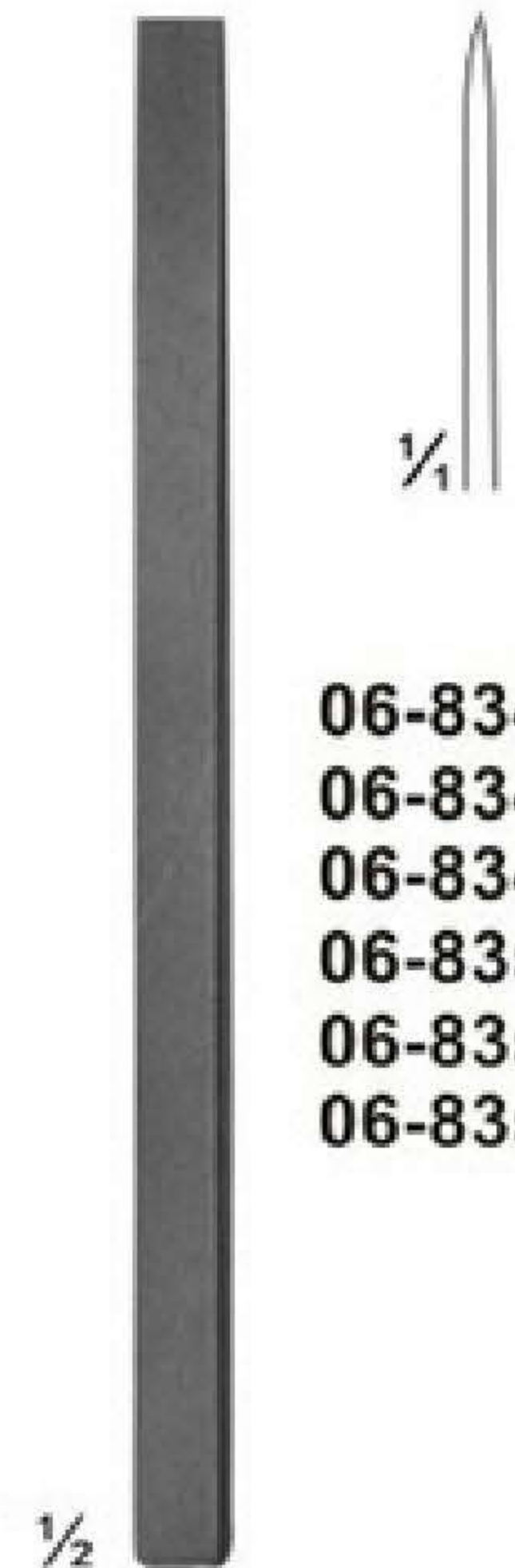

06-8347 4 mm
06-8348 6 mm
06-8349 8 mm
06-8350 10 mm
06-8351 12 mm
06-8352 15 mm

LAMBOTTE
06-8347 - 06-8352
Osteotomes
125 mm

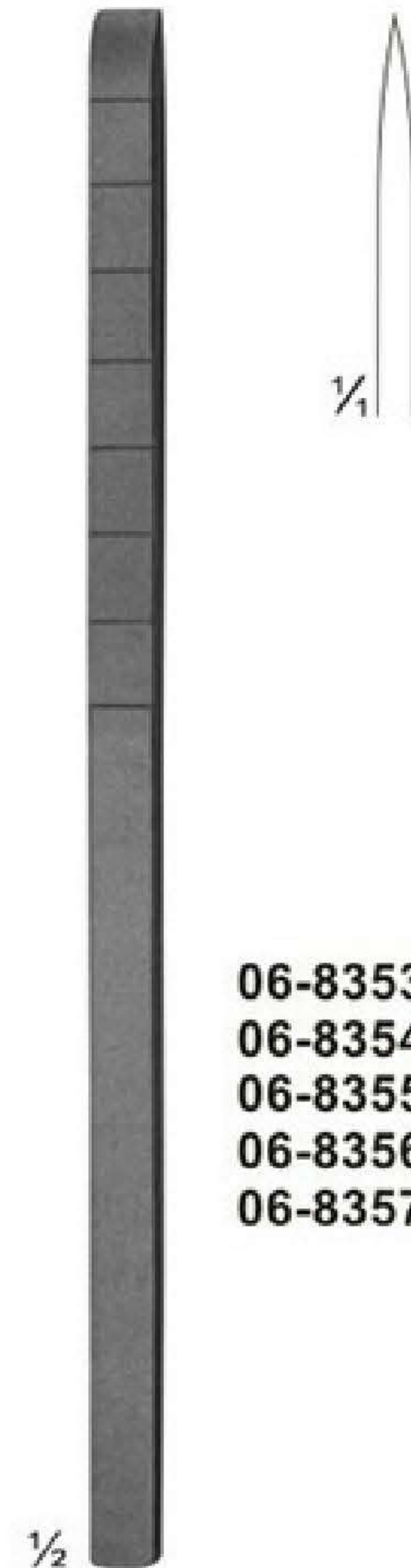

06-8353 4 mm
06-8354 6 mm
06-8355 8 mm
06-8356 10 mm
06-8357 12 mm

COTTLE
06-8353 - 06-8357
Osteotomes with depth
markings
180 mm

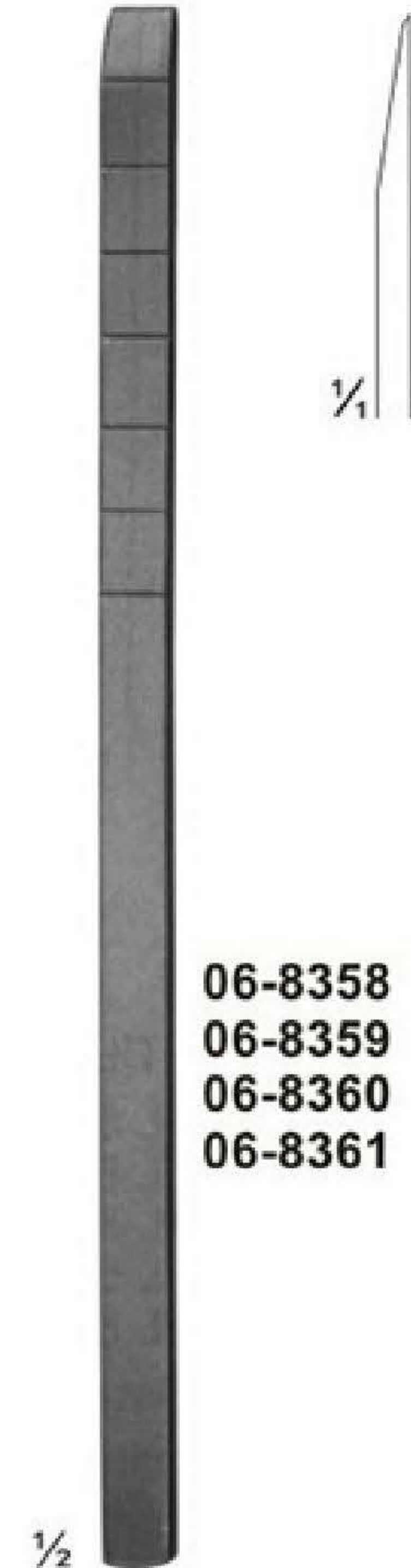

06-8358 4 mm
06-8359 7 mm
06-8360 9 mm
06-8361 12 mm

COTTLE
06-8358 - 06-8361
Chisel-Osteotomes
with depth markings
180 mm

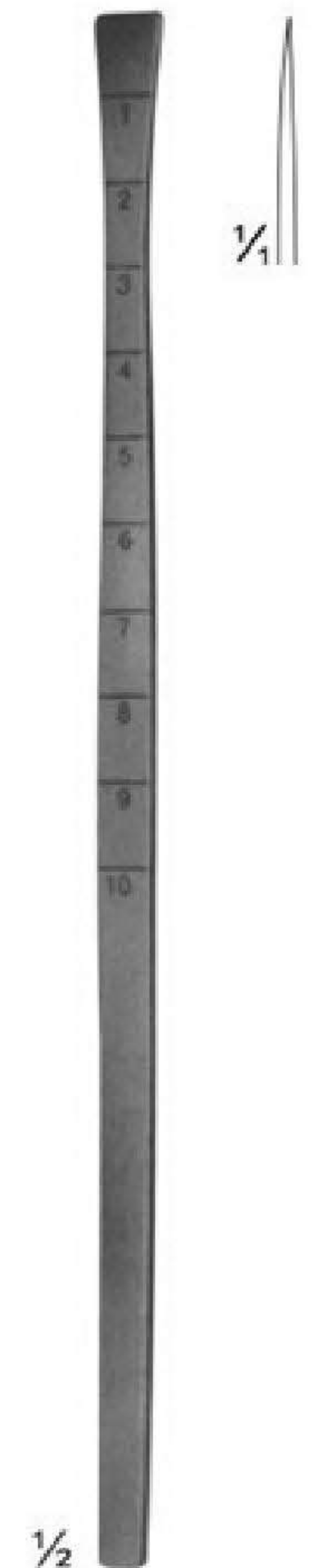

COTTLE
06-8362 8mm
Fishtail Chisel,
with protected ends
180 mm

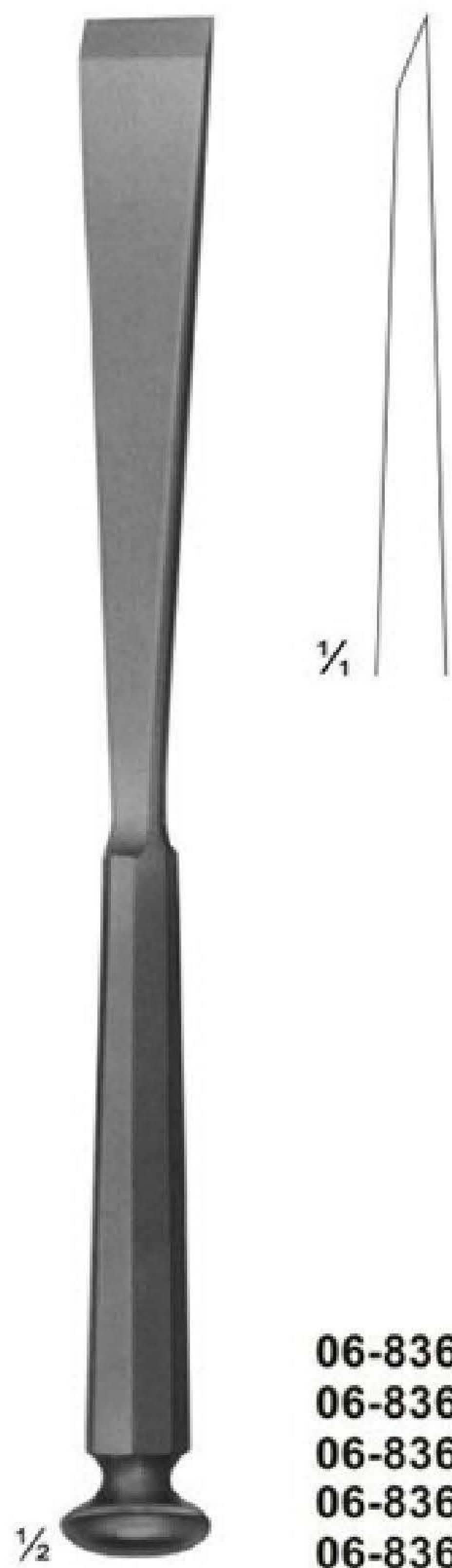

06-8363 10 mm
06-8364 12 mm
06-8365 15 mm
06-8366 20 mm
06-8367 25 mm

STILLE
06-8363 - 06-8367
Chisels
205 mm

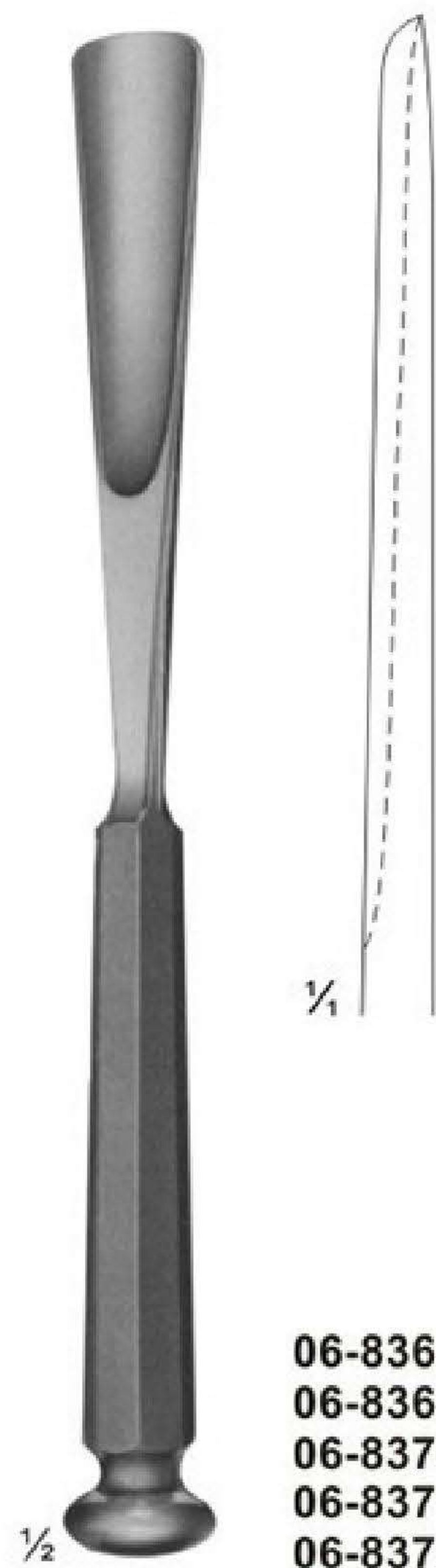

06-8368 10 mm
06-8369 12 mm
06-8370 15 mm
06-8371 20 mm
06-8372 25 mm

STILLE
06-8368 - 06-8372
Gouges
205 mm

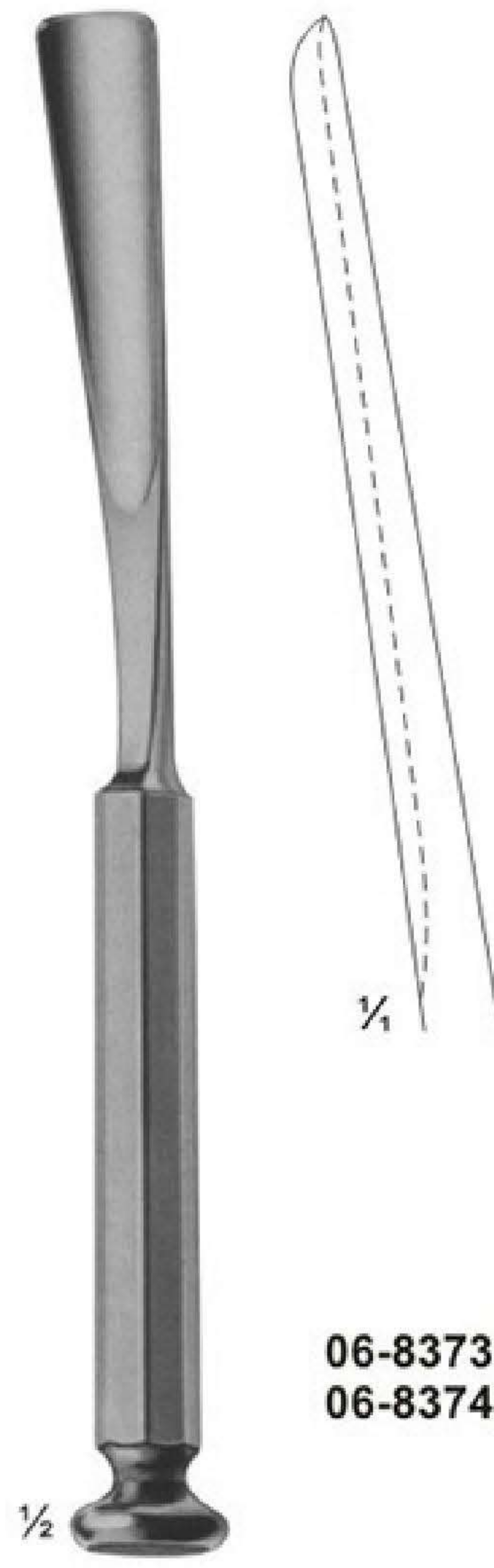

06-8373 10 mm
06-8374 15 mm

WALTER
06-8373 - 06-8374
gouges for taking
grafts from the ribs
205 mm



06-8375 8mm
06-8376 10 mm
06-8377 12 mm
06-8378 15 mm
06-8379 20 mm
06-8380 25 mm

STILLE
06-8375 - 06-8380
Osteotomes
205 mm

Osteotomes



STILLE
 06-8381 - 06-8385
 Osteotomes
 205 mm

STILLE
 06-8386 - 06-8390
 Osteotomes, curved
 205 mm

LAMBOTTE
 06-8391 - 06-8402
 Osteotomes
 245 mm

LAMBOTTE
 06-8403 - 06-8408
 Osteotomes, curved
 245 mm

Osteotomes, Chisels and Gouges with HARTPRESS -handle



- 06-8409 4 mm
- 06-8410 6 mm
- 06-8411 8 mm
- 06-8412 10 mm
- 06-8413 12 mm

LEXER-MINI
06-8409 - 06-8413
Osteotomes
180 mm



- 06-8414 4 mm
- 06-8415 6 mm
- 06-8416 8 mm
- 06-8417 10 mm
- 06-8418 12 mm

LEXER-MINI
06-8414 - 06-8418
Gouges
180 mm



- 06-8419 5 mm
- 06-8420 7 mm
- 06-8421 10 mm
- 06-8422 15 mm
- 06-8423 20 mm
- 06-8424 25 mm
- 06-8425 30 mm

LEXER
06-8419 - 06-8425
Gouges
220 mm



- 06-8426 5 mm
- 06-8427 7 mm
- 06-8428 10 mm
- 06-8429 15 mm
- 06-8430 20 mm
- 06-8431 25 mm
- 06-8432 30 mm

LEXER
06-8426 - 06-8432
Osteotomes
220 mm

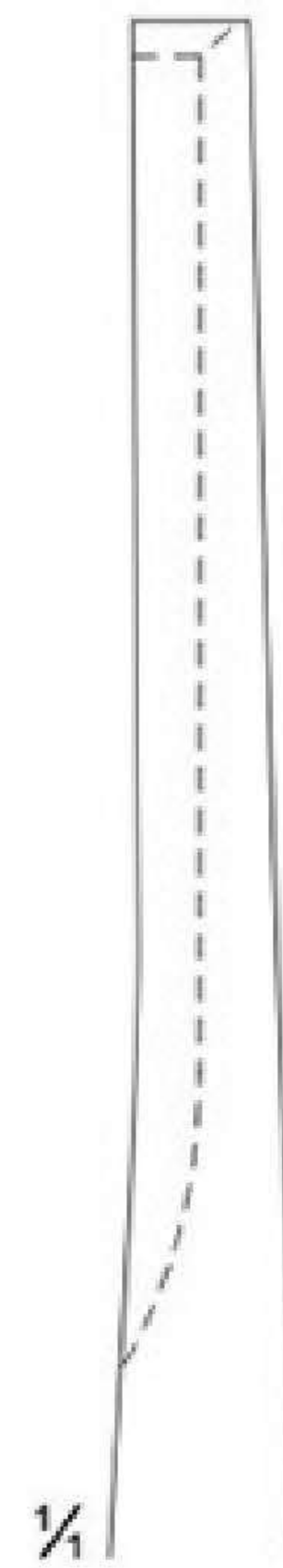

06-8433 9mm
Gouge for
removing broken
screws
220 mm



- 06-8434 5,5 mm
- 06-8435 9,0 mm

ZIELKE
06-8434 - 06-8435
Gouges for
scoliosis-operations
230 mm

Osteotomes ,Chisels and Gouges with HARTPRESS -handle



Reposition Forceps

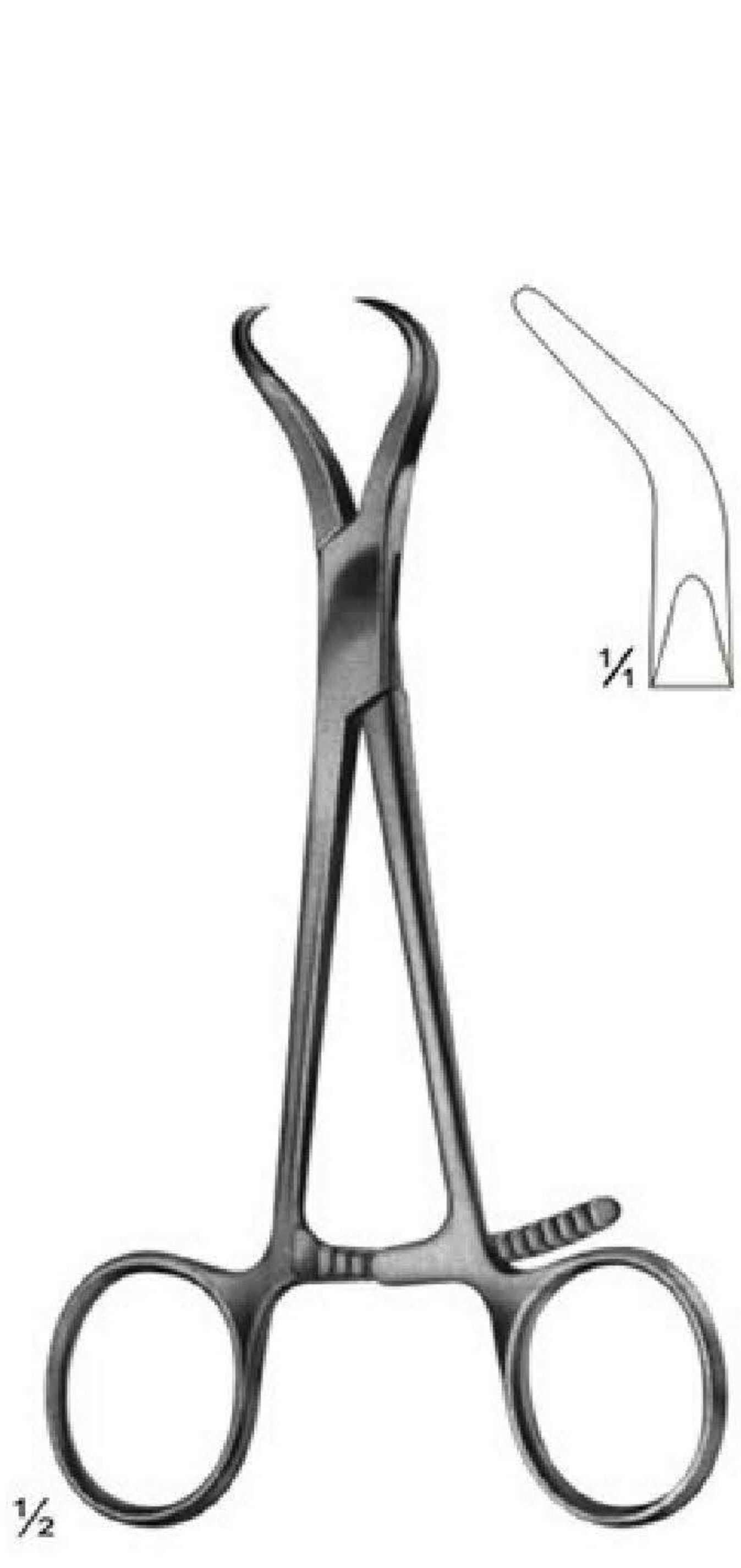

06-8442
Reposition forceps,
for small fragments
135 mm



06-8443
HAASE
Reposition forceps,
for mandibular
fractures
165 mm



06-8444
REILL
Reposition forceps,
170 mm



06-8445
Reposition forceps
205 mm

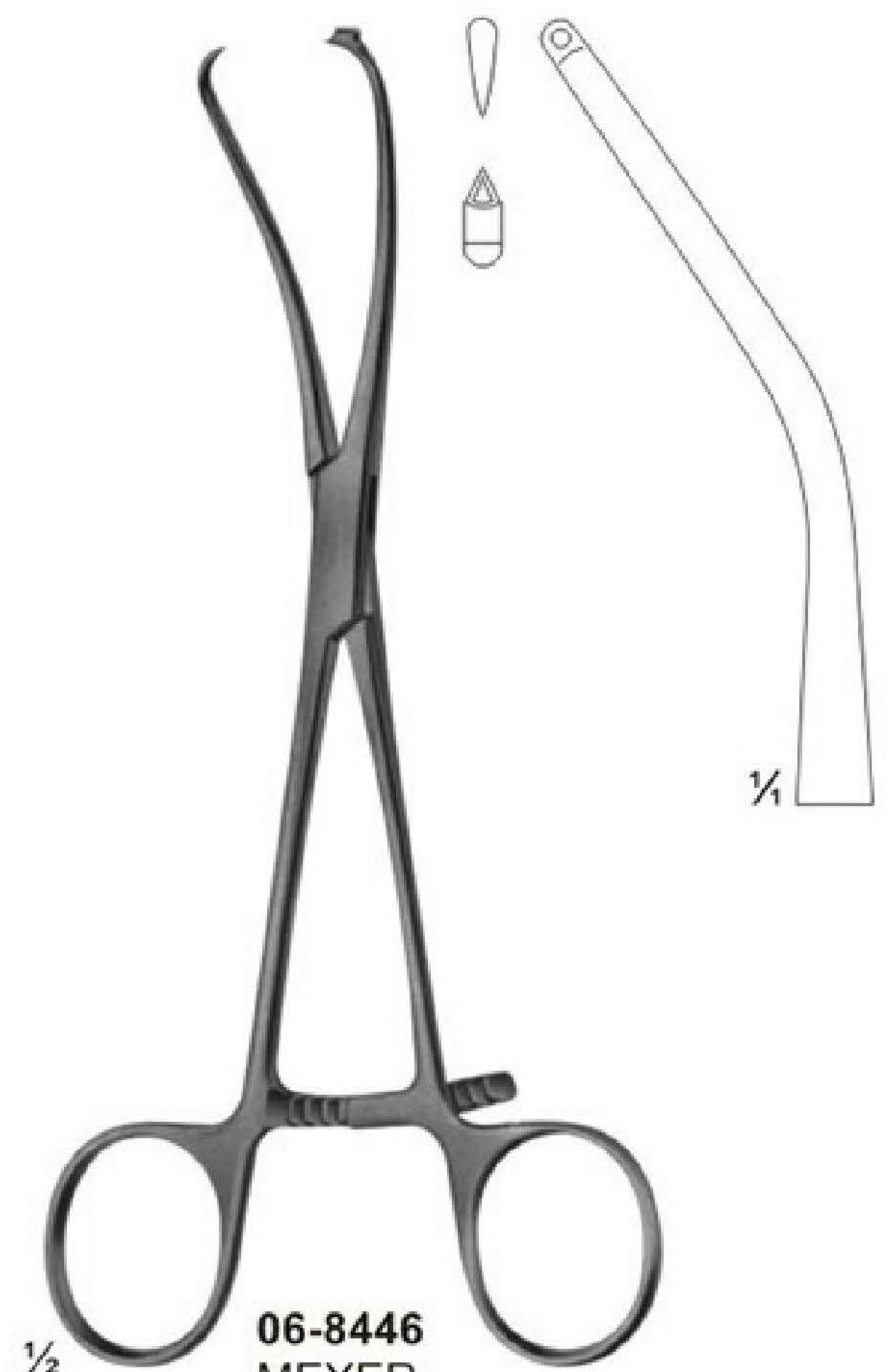

06-8446
MEYER
Reposition forceps
for fingers, with drill
guide for KIRSCHNER
wires up to diam. 1.0 mm
170 mm

Reposition Forceps, Bone Holding Forceps



06-8447
Patella forceps
185 mm



06-8448
Forceps with
ratchet fixation
140 mm



06-8449
Forceps with
thread fixation
170 mm



06-8450
Forceps with
thread fixation
235 mm

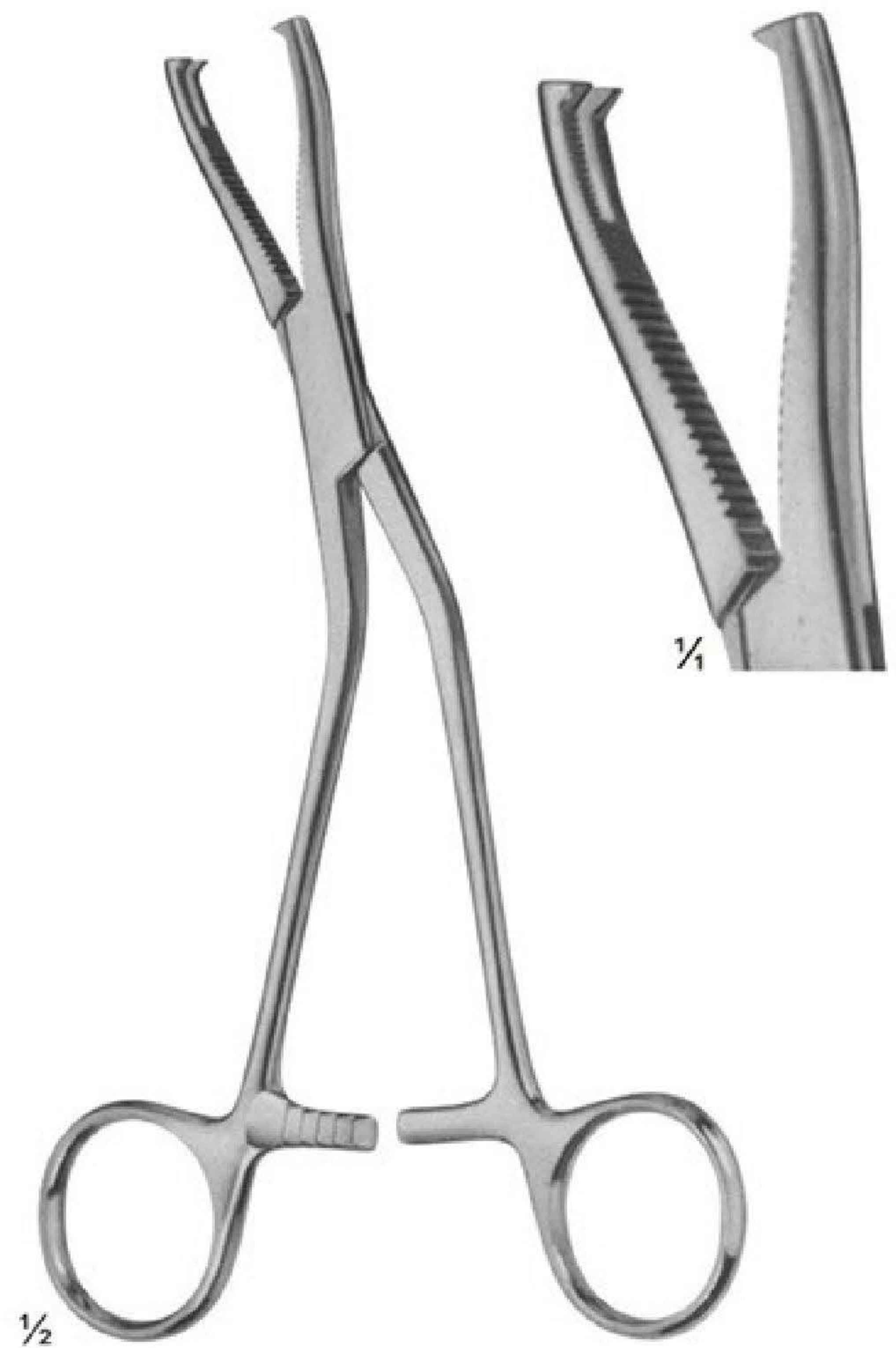

06-8451
DINGMANN modif
185 mm

Bone Holding Forceps



06-8452
Sequestrum
forceps
200 mm



06-8453
VAN BUREN
Sequestrum
forceps
225 mm



06-8454
LANGENBECK
205 mm



06-8455
FERGUSON
205 mm

Bone Holding Forceps

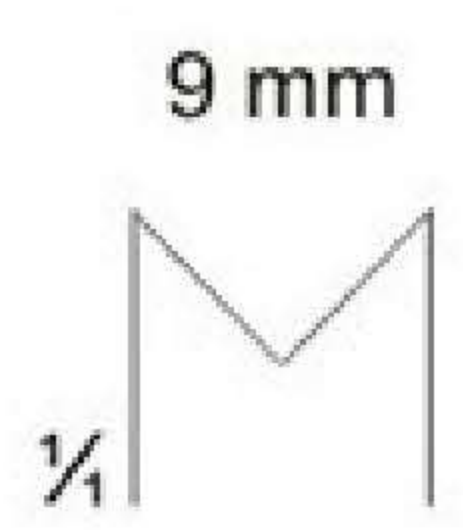
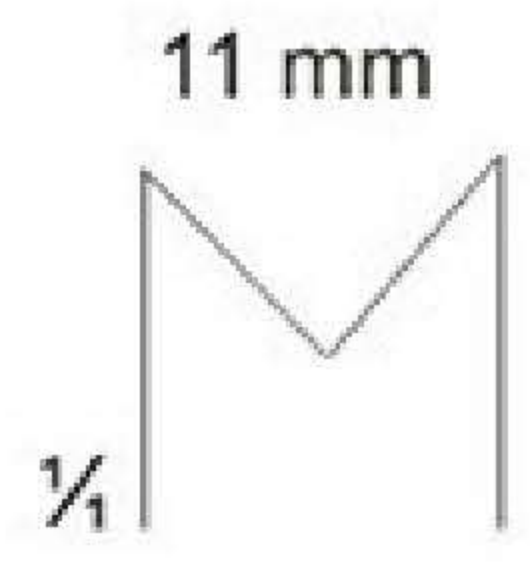
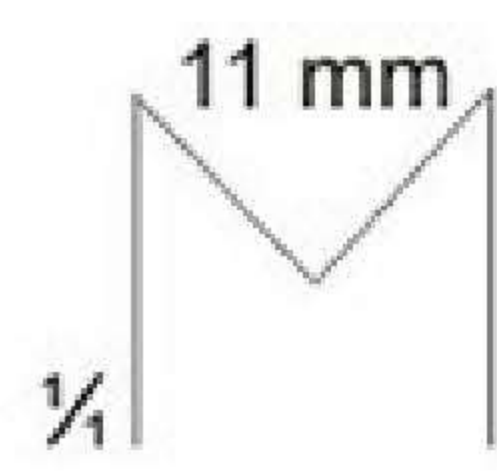
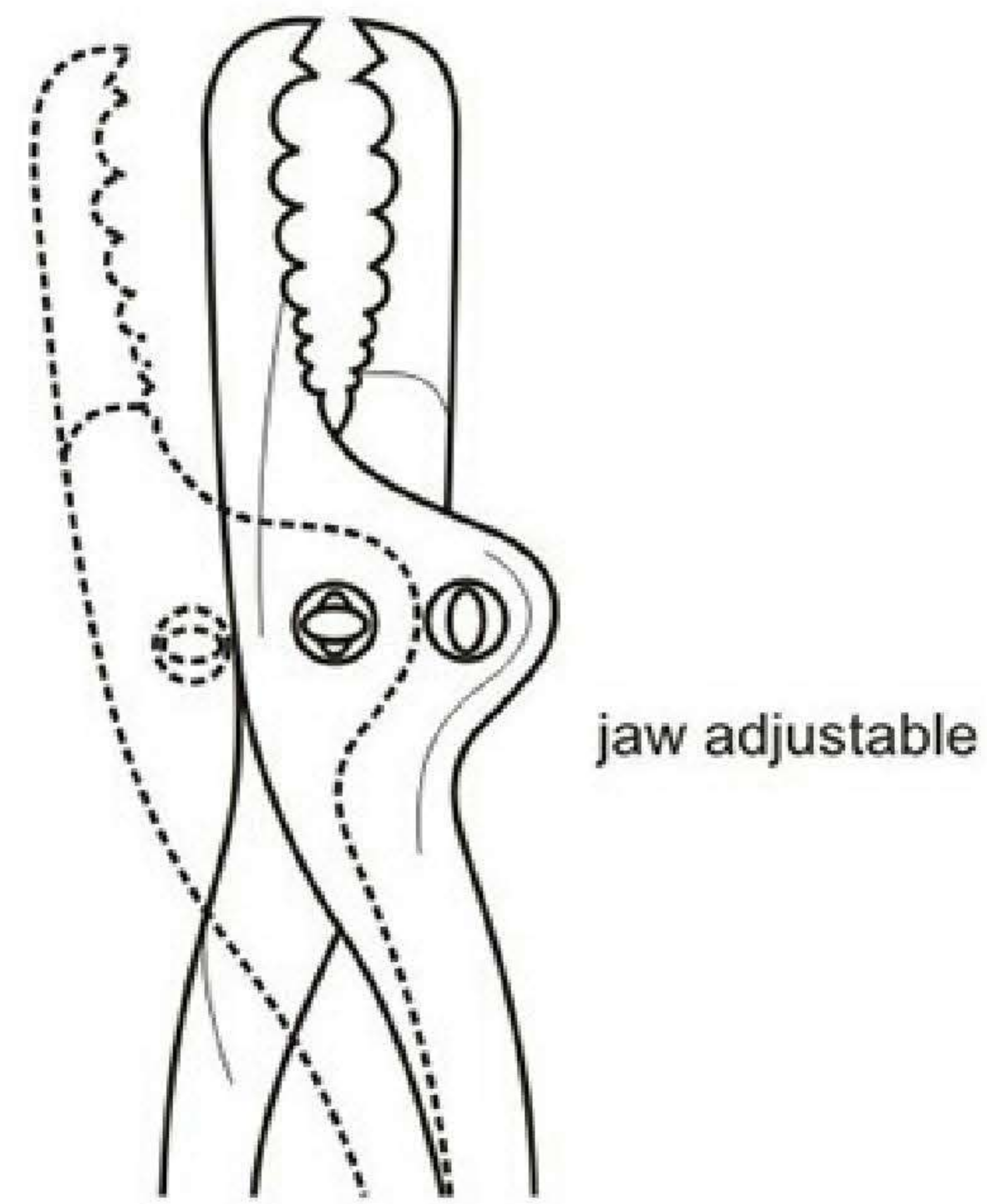

8 mm



06-8456
 SEMB
 190 mm



06-8457
 FARABEUF
 230 mm



06-8458
 FARABEUF
 255 mm



06-8459
 FARABEUF-LAMBOTTE
 255 mm

Bone Holding Forceps

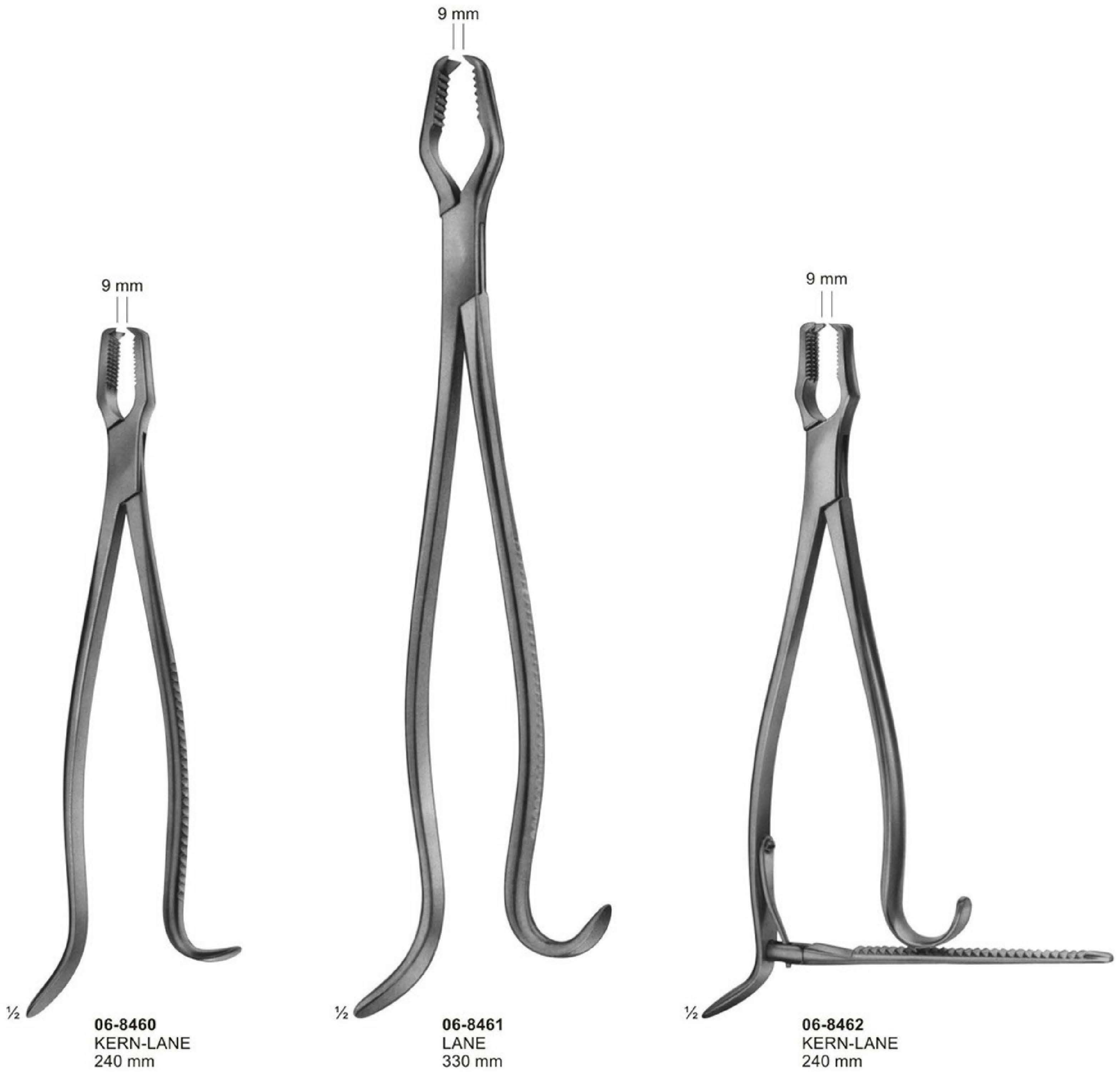

Bone Holding Forceps



06-8463
LANE
320 mm



06-8464
HEY GROVES
305 mm

Bone Holding Forceps



06-8465 - 06-8469

- 06-8465 145 mm
- 06-8466 190 mm
- 06-8467 240 mm
- 06-8468 260 mm
- 06-8469 280 mm

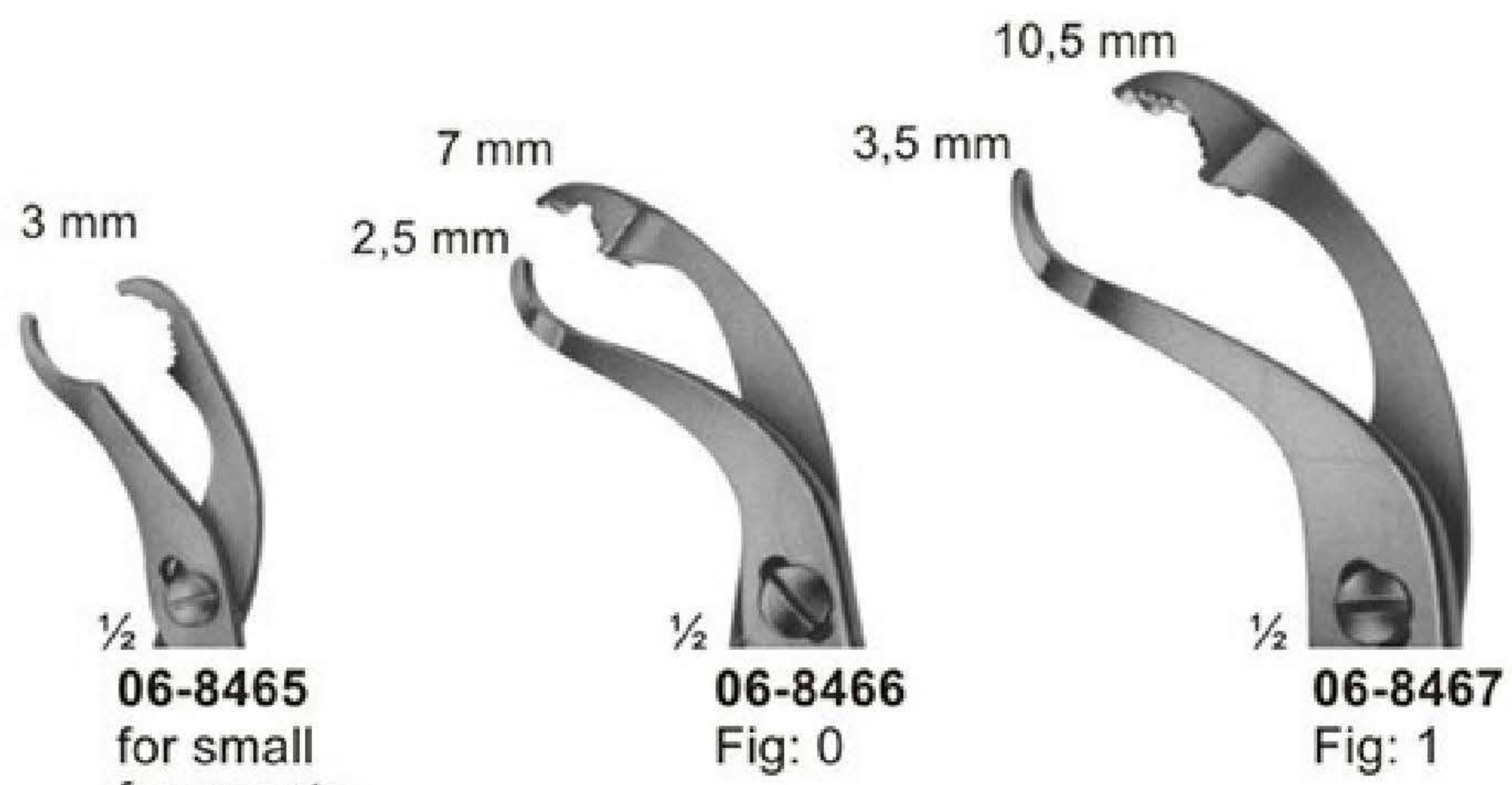

06-8465
 for small
 fragments
 11 mm

06-8466
 Fig: 0

06-8467
 Fig: 1

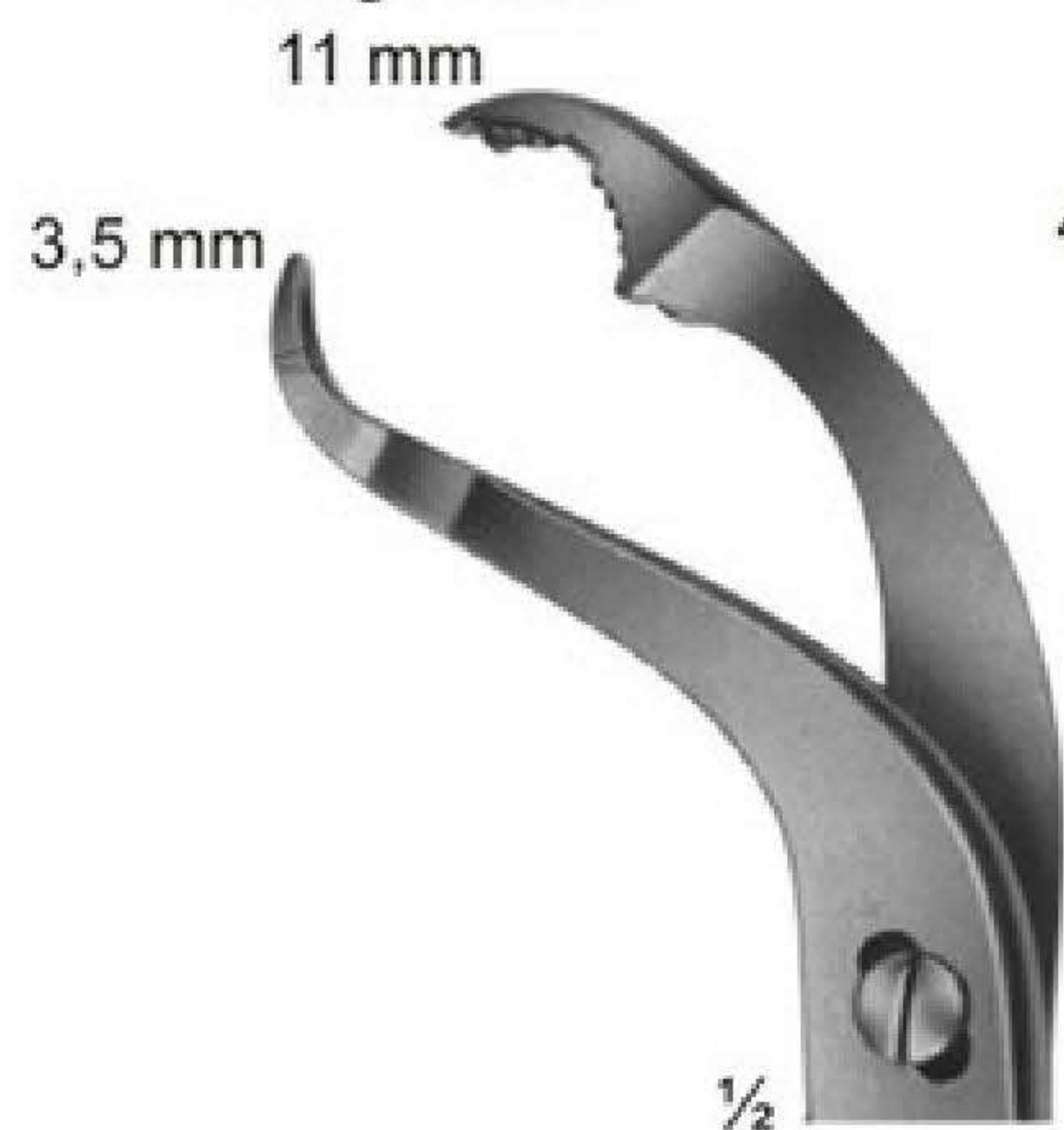

06-8468
 Fig: 2



06-8469
 Fig: 3

Self-centering forceps
 with thread fixation



06-8470 - 06-8472
 VERBRUGGE

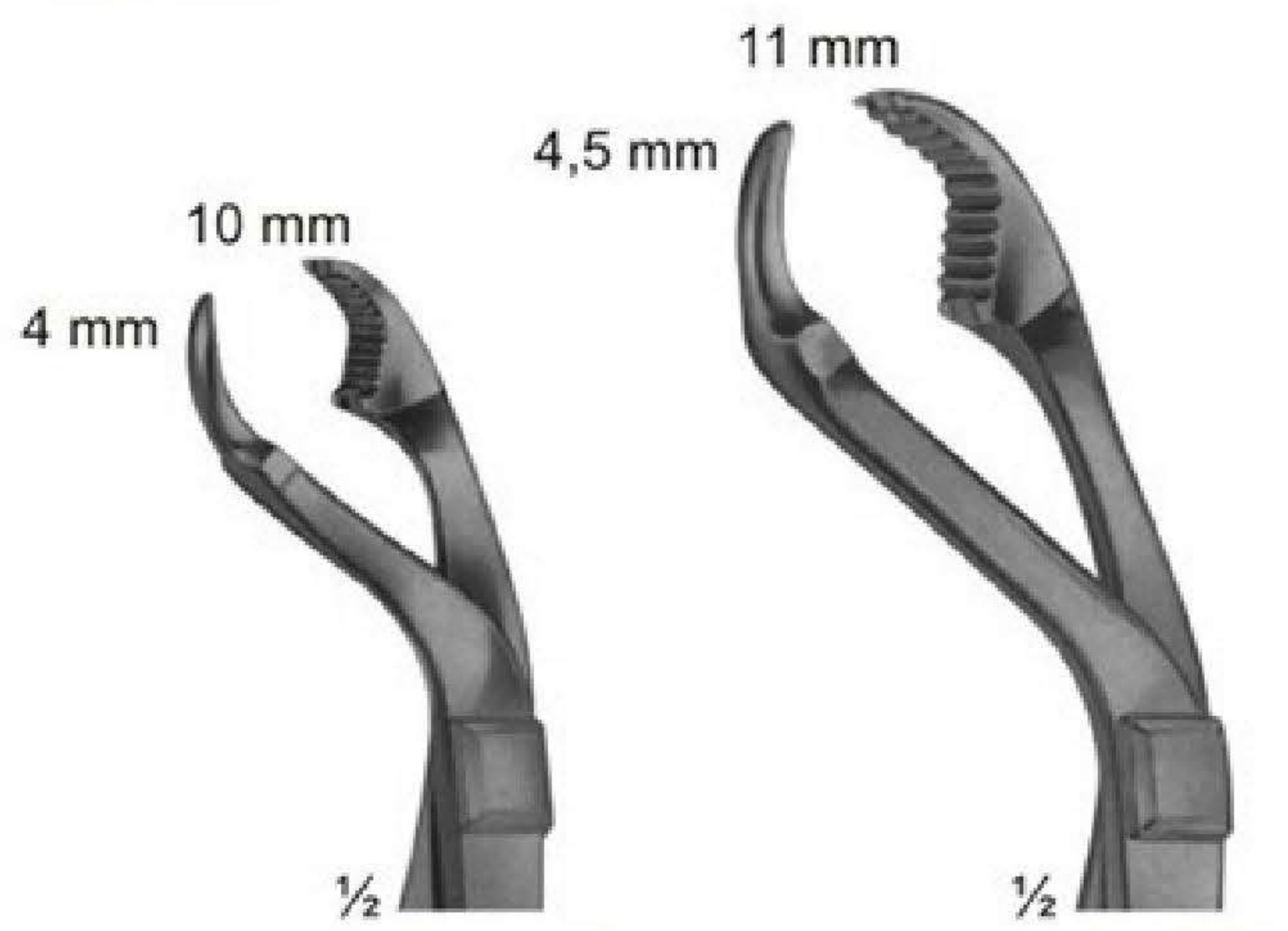

06-8470
 Fig: 1

06-8471
 Fig: 2



06-8472
 Fig: 3

With lip joint



06-8473
 LAMBOTTE
 265 mm

Bone Clamps



06-8474 - 06-8475
 LOWMAN
 06-8474 170 mm
 06-8475 205 mm



06-8476
 LOWMAN-GERSTER
 210 mm



06-8477
 LOWMAN-HOGLUND
 175 mm

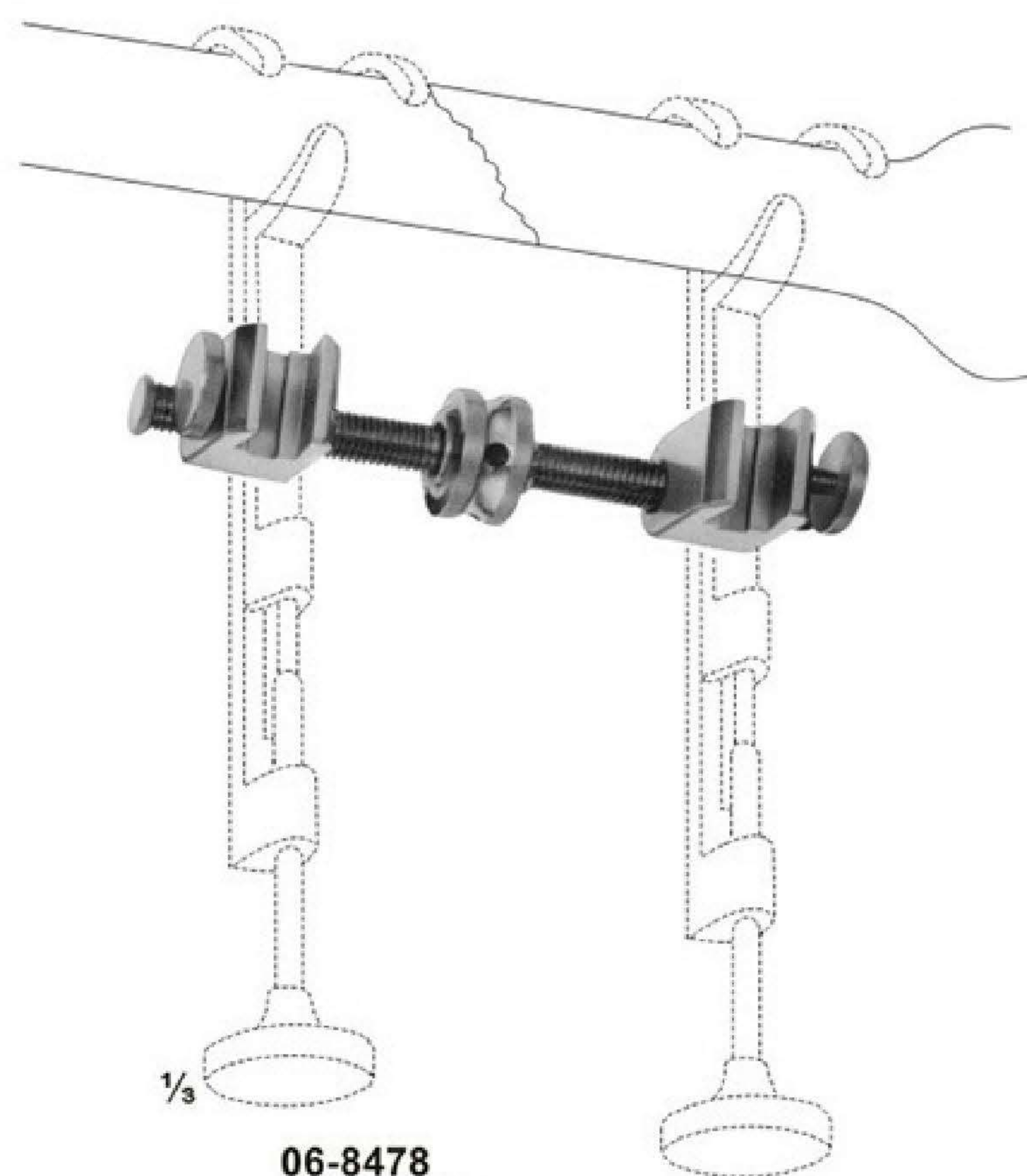

06-8478
 GERSTER
 Traction bar for 06-8474 - 06-8477

Synovectomy-Rongeurs, Bone Rongeurs



06-8479 06-8480

06-8479 - 06-8480
Synovectomy rongeur
width of jaws 1.2 mm
130 mm

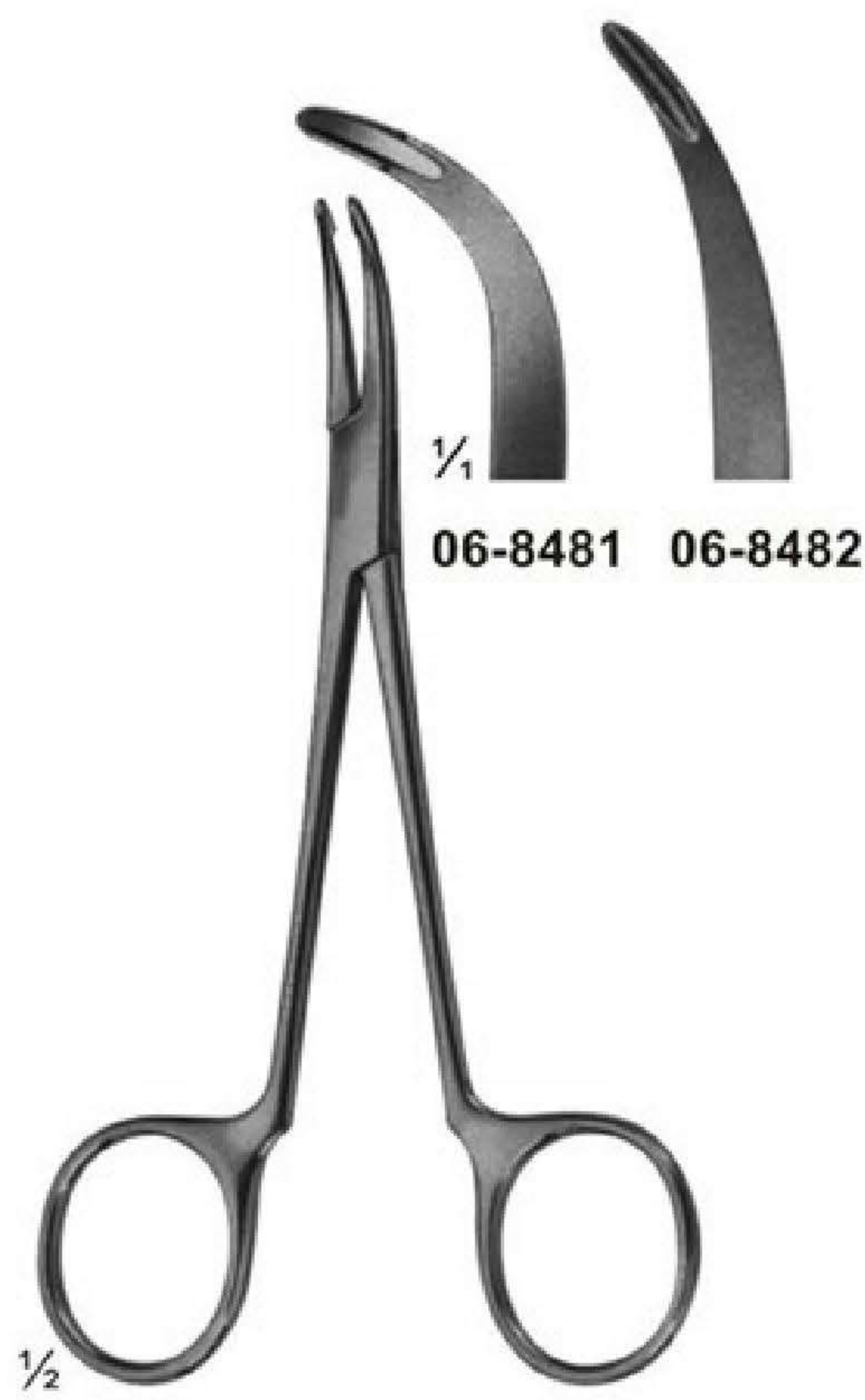

06-8481 06-8482

06-8481 - 06-8482
Synovectomy rongeur
width of jaws 2.0 mm
130 mm



06-8483
STELLBRINK
Synovectomy rongeur
175 mm

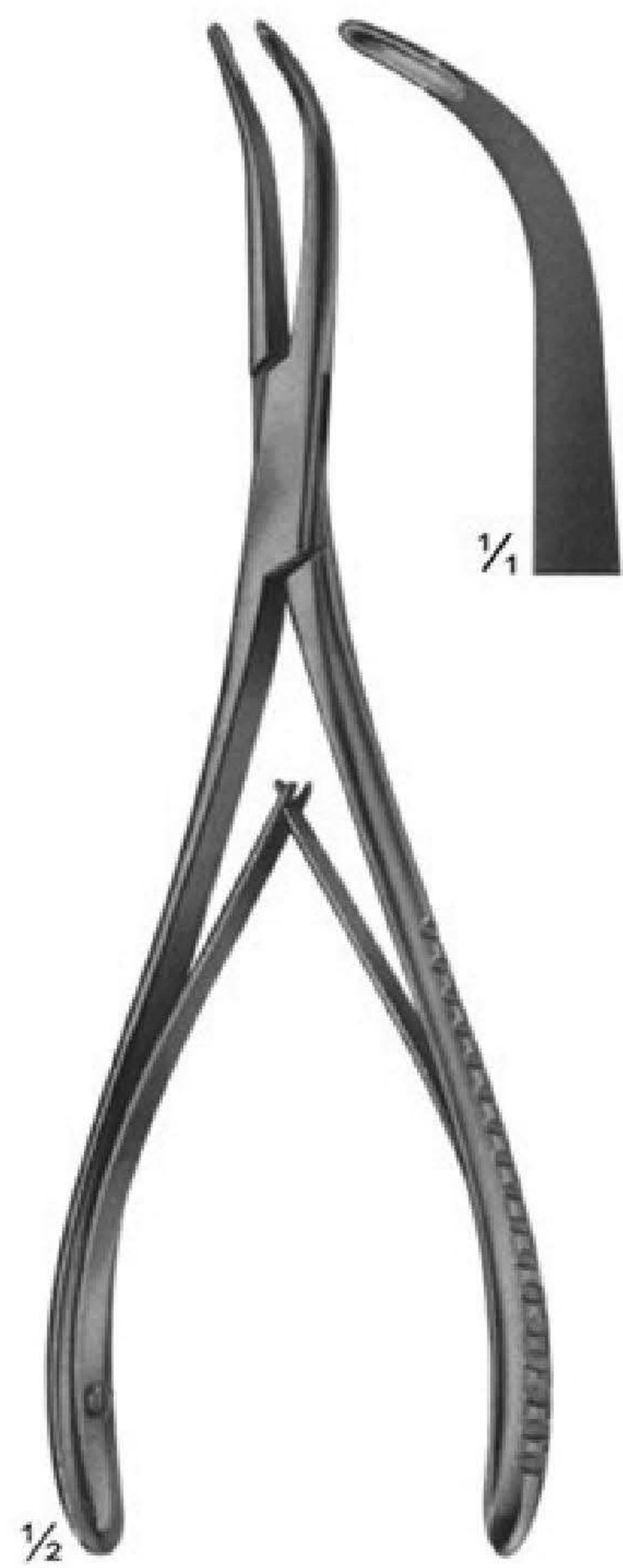

06-8484
STELLBRINK
Synovectomy rongeur
170 mm



06-8485
LUER-FRIEDMANN
145 mm

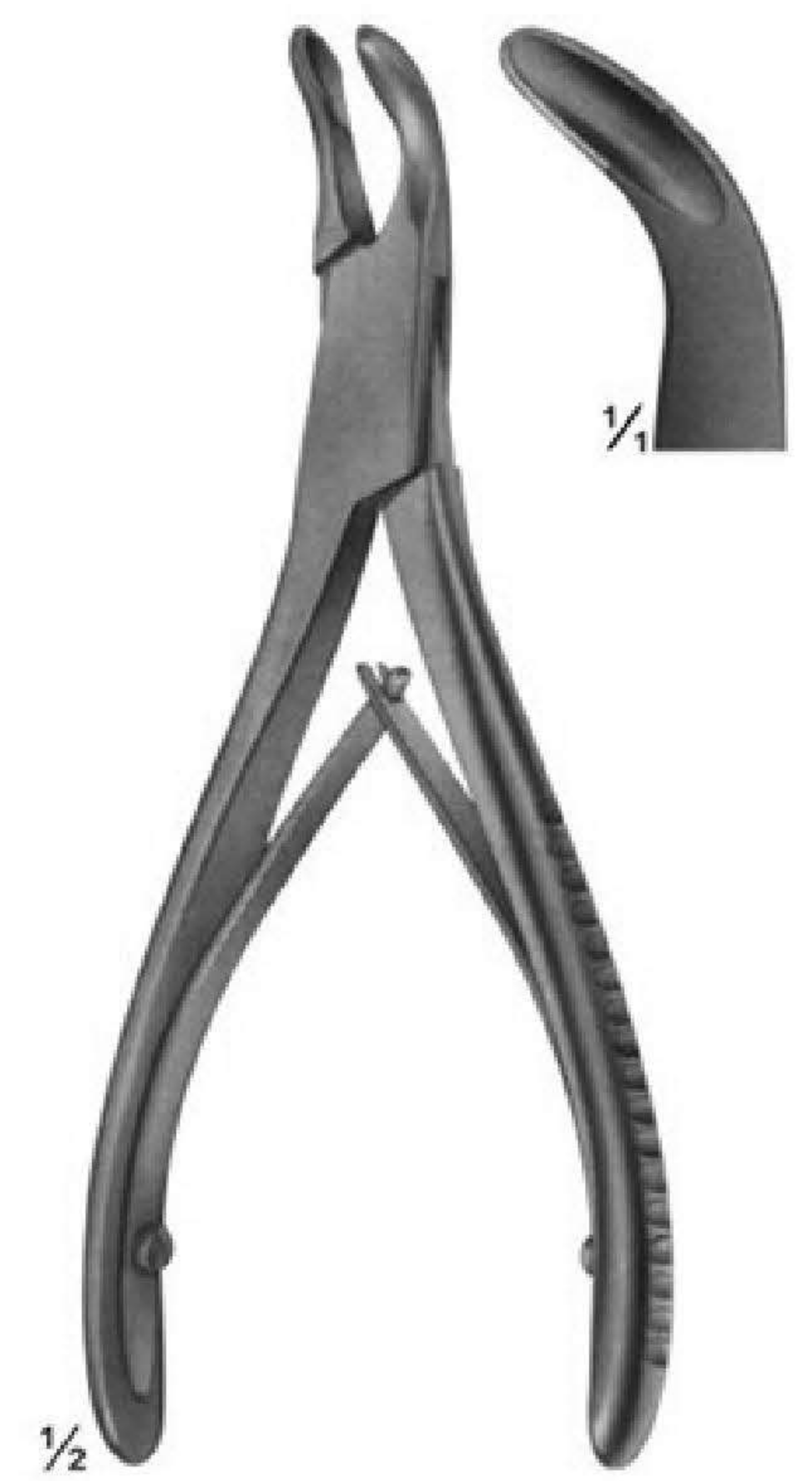

06-8486
140 mm

Bone Rongeurs



06-8487
 LUER
 150 mm

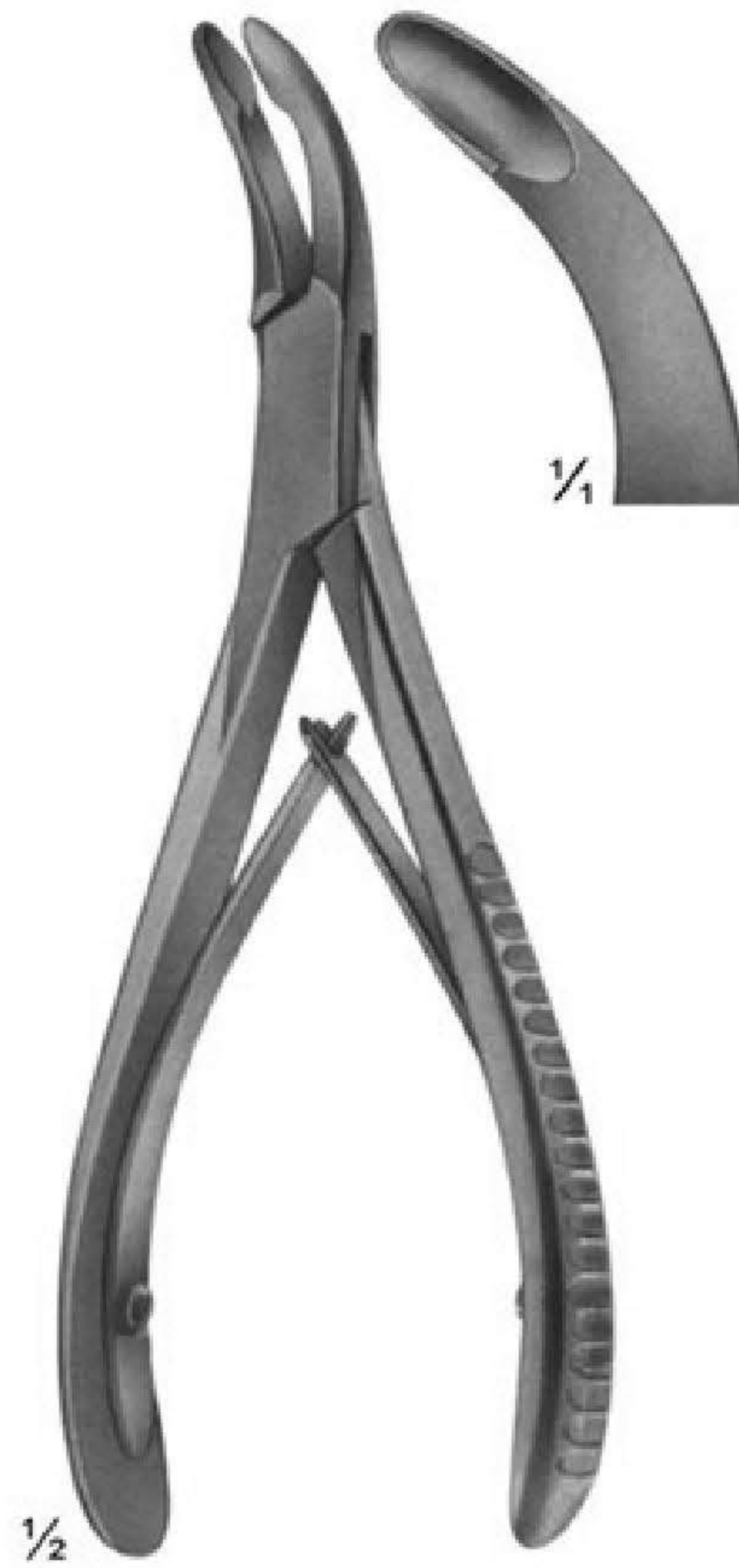

06-8488
 LUER
 155 mm

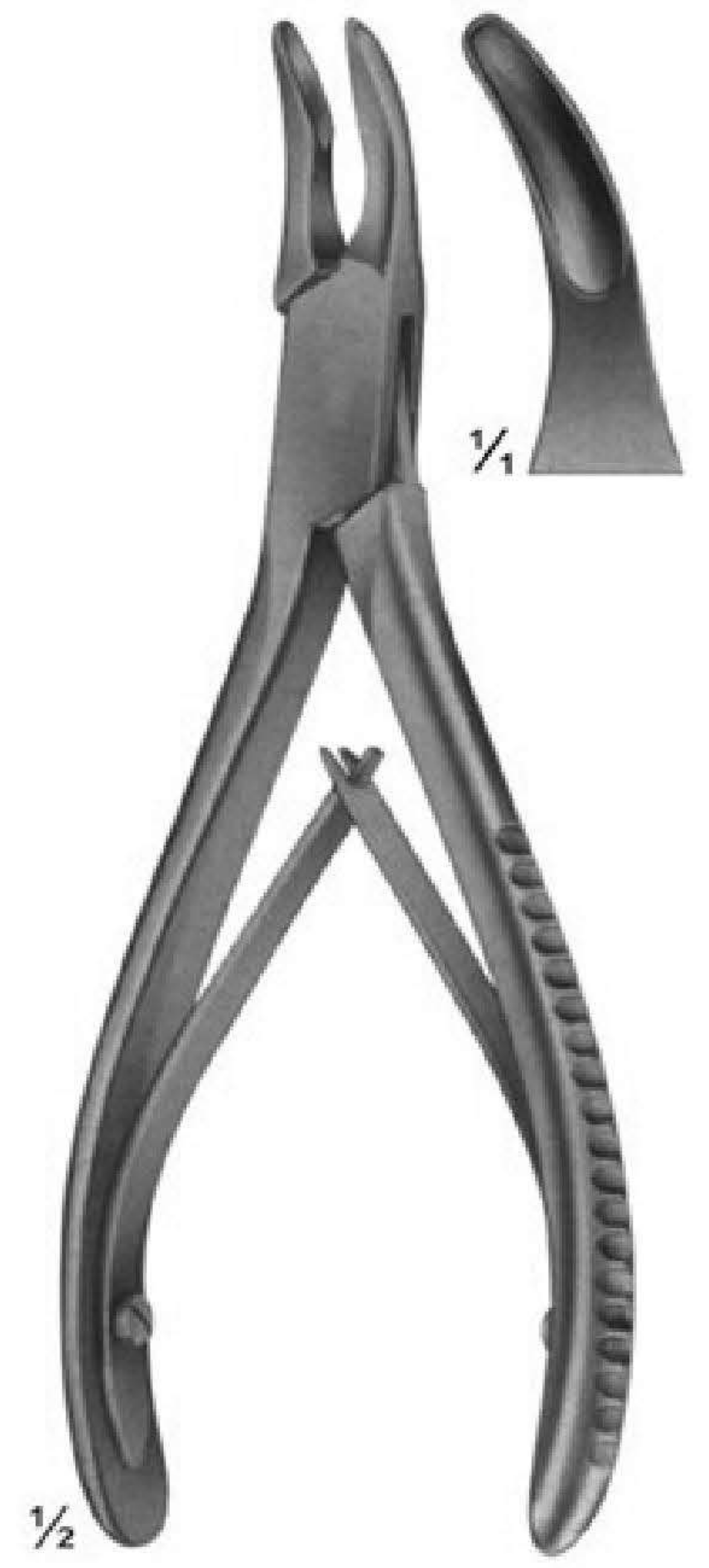

06-8489
 BLUMENTHAL
 155 mm



06-8490
 BLUMENTHAL
 150 mm



06-8491 - 06-8492
 JANSEN
 175 mm

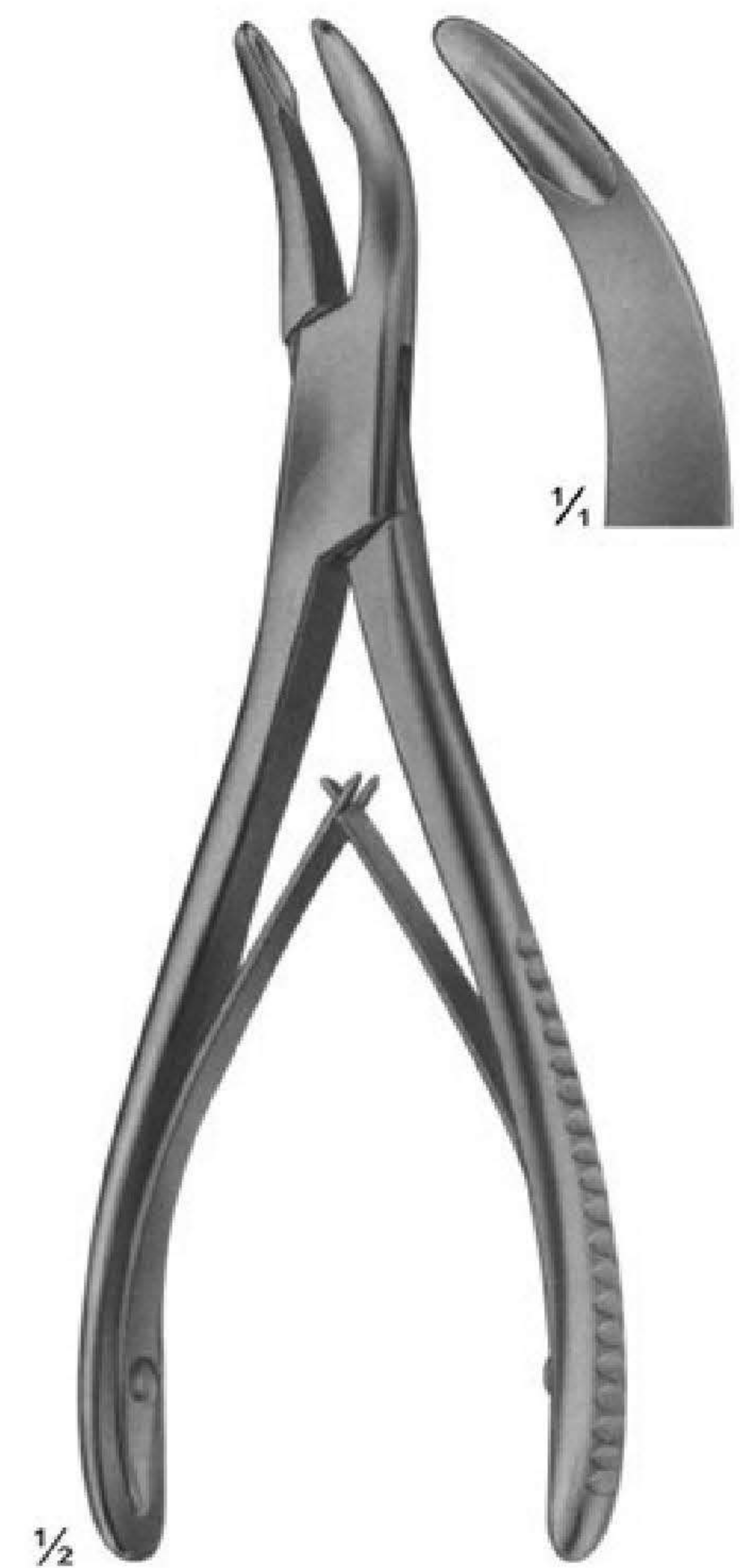

06-8493
 BANE-HARTMANN
 175 mm

Bone Rongeurs



06-8494
ALEXANDER
140 mm

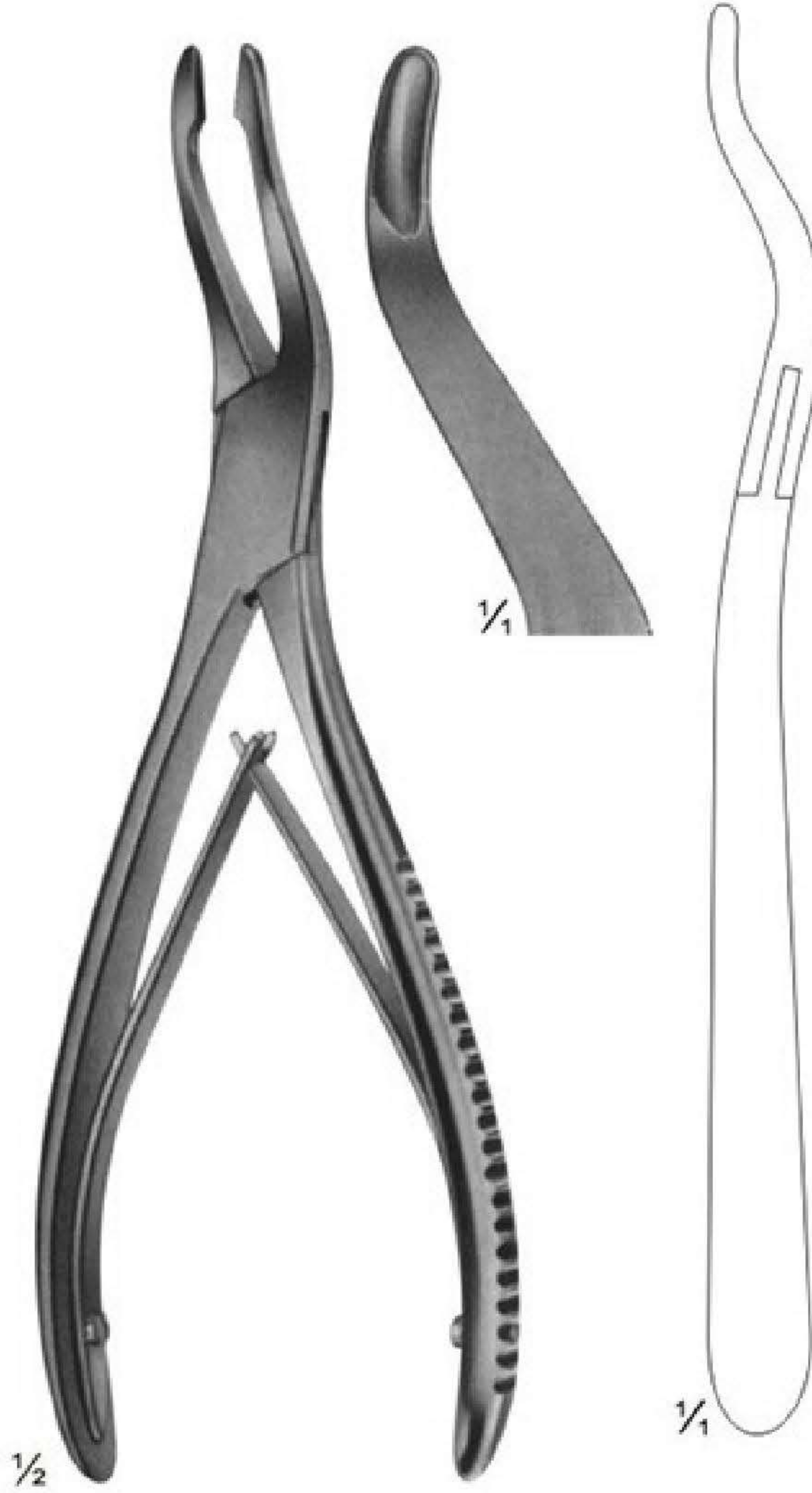

06-8495
JANSEN
190 mm

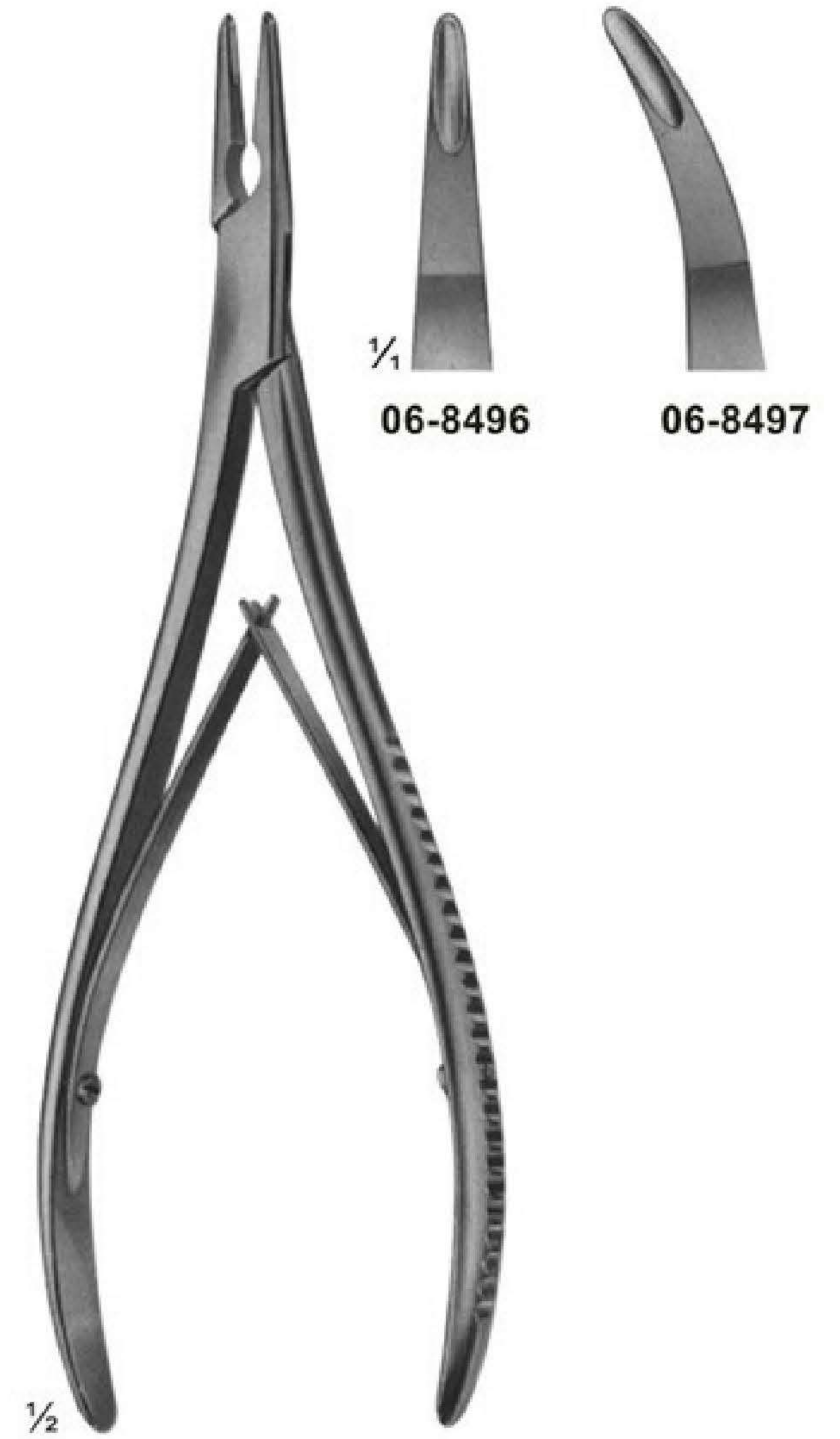

06-8496 - 06-8497
LEMPERT
200 mm

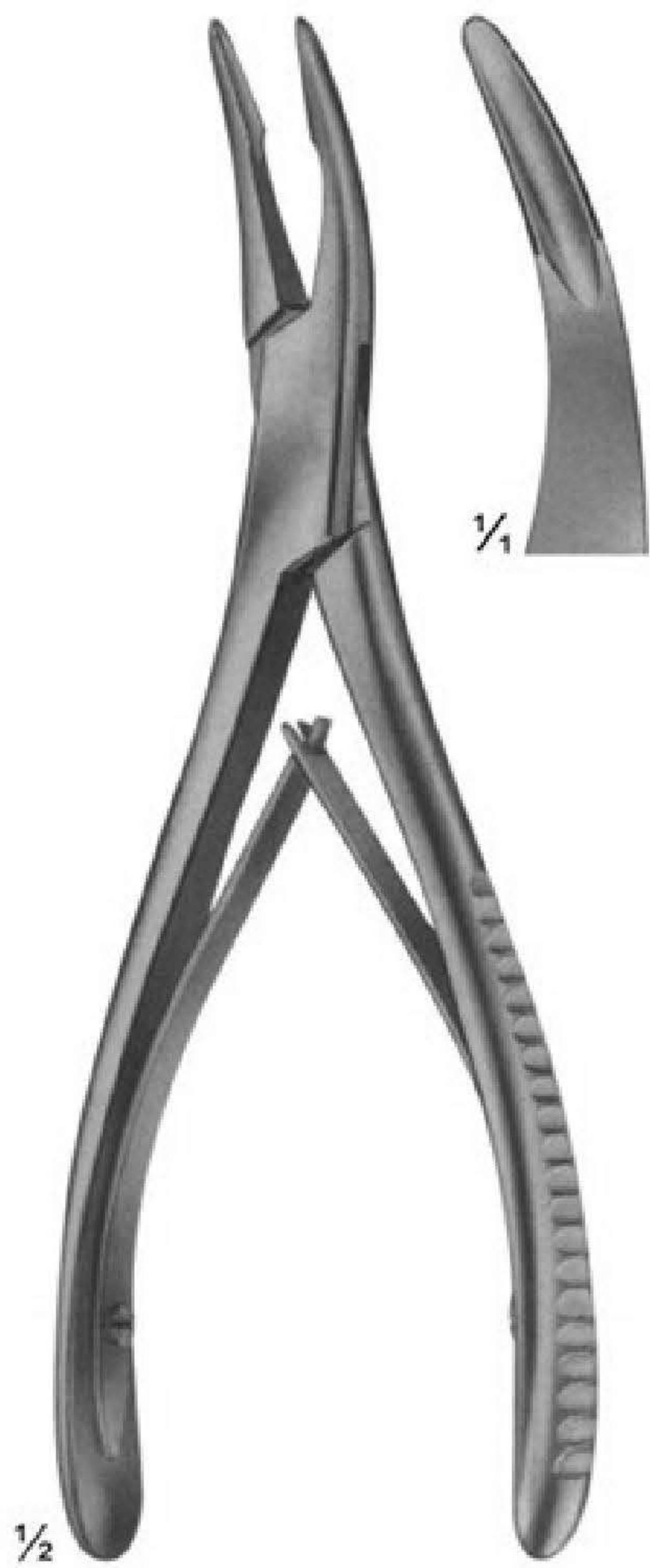

06-8498
BEYER
180 mm

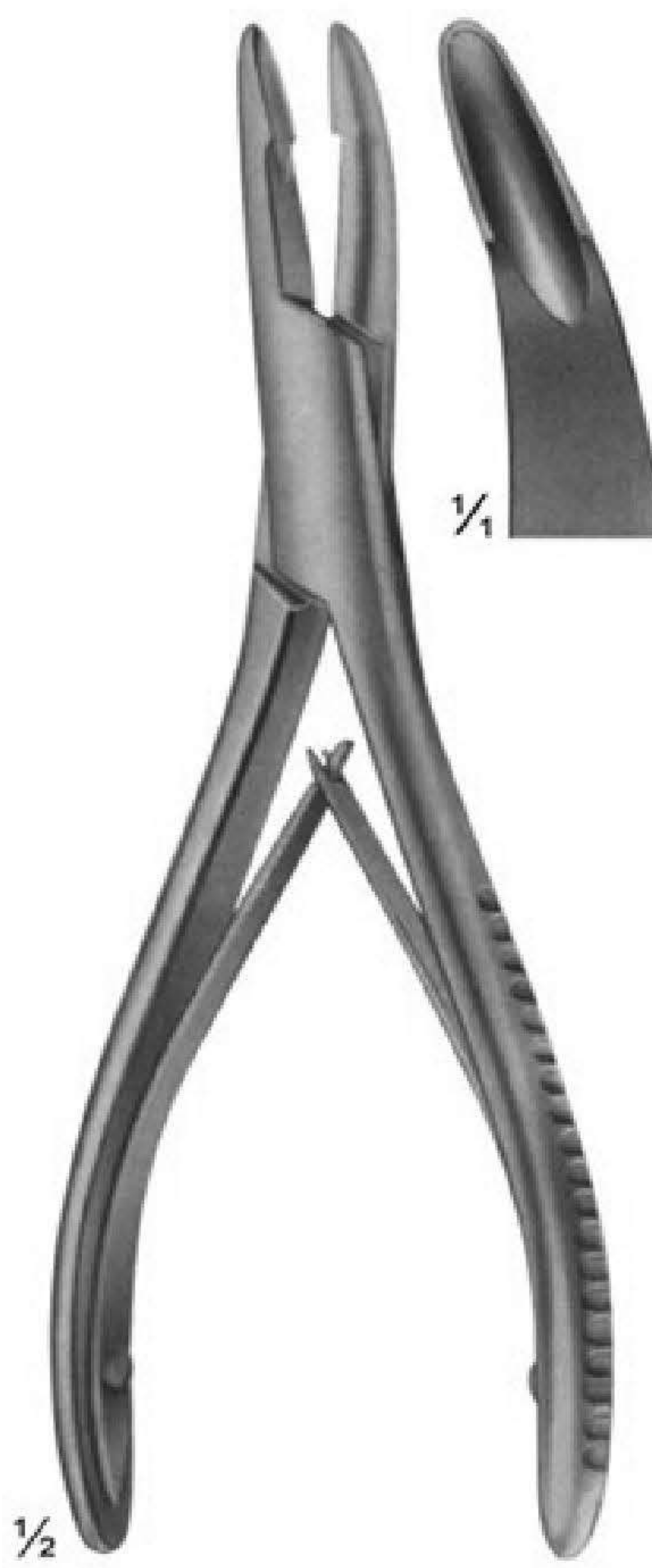

06-8499
MEAD
165 mm

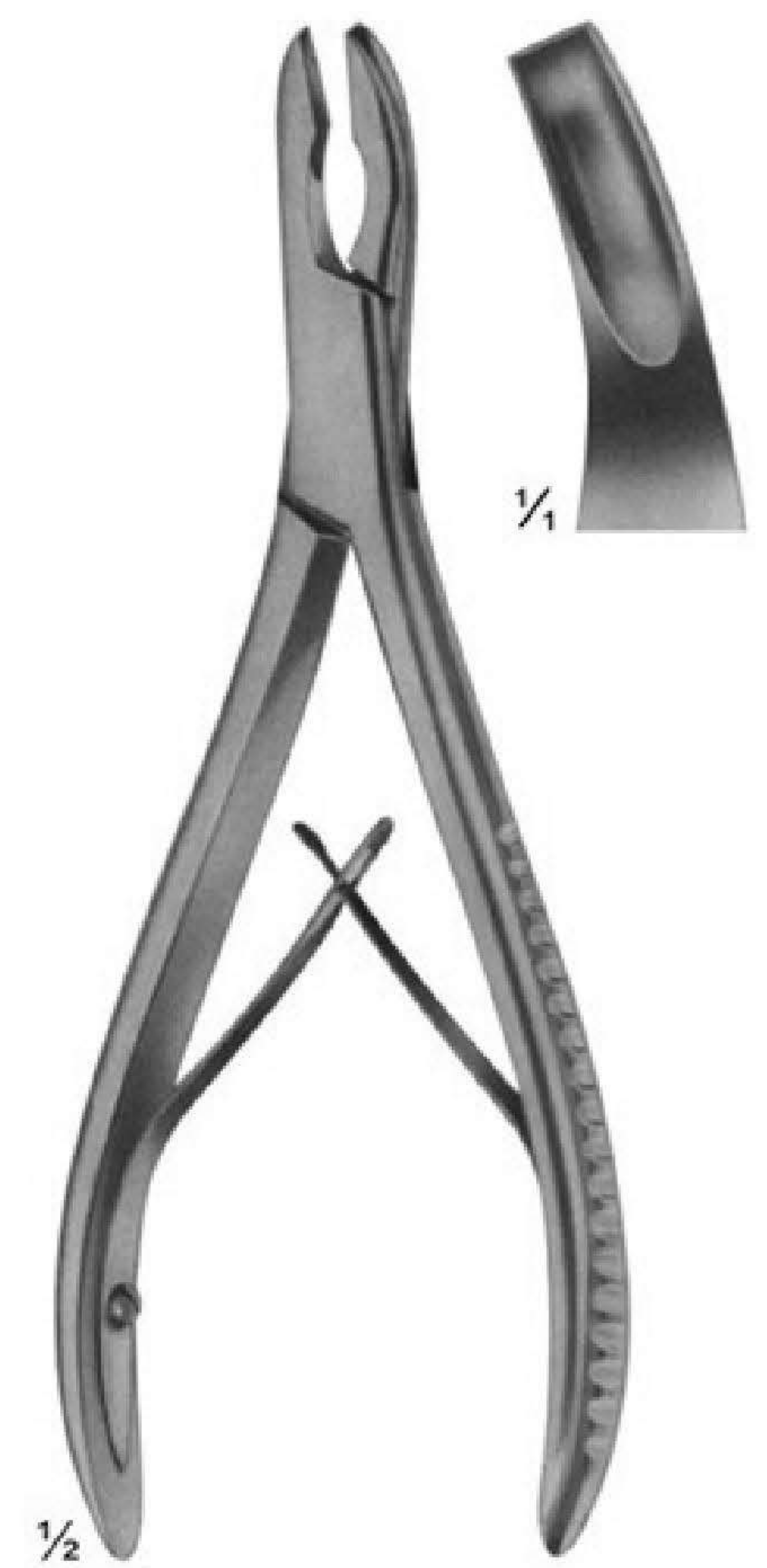

06-8500
MEAD
165 mm

Bone Rongeurs

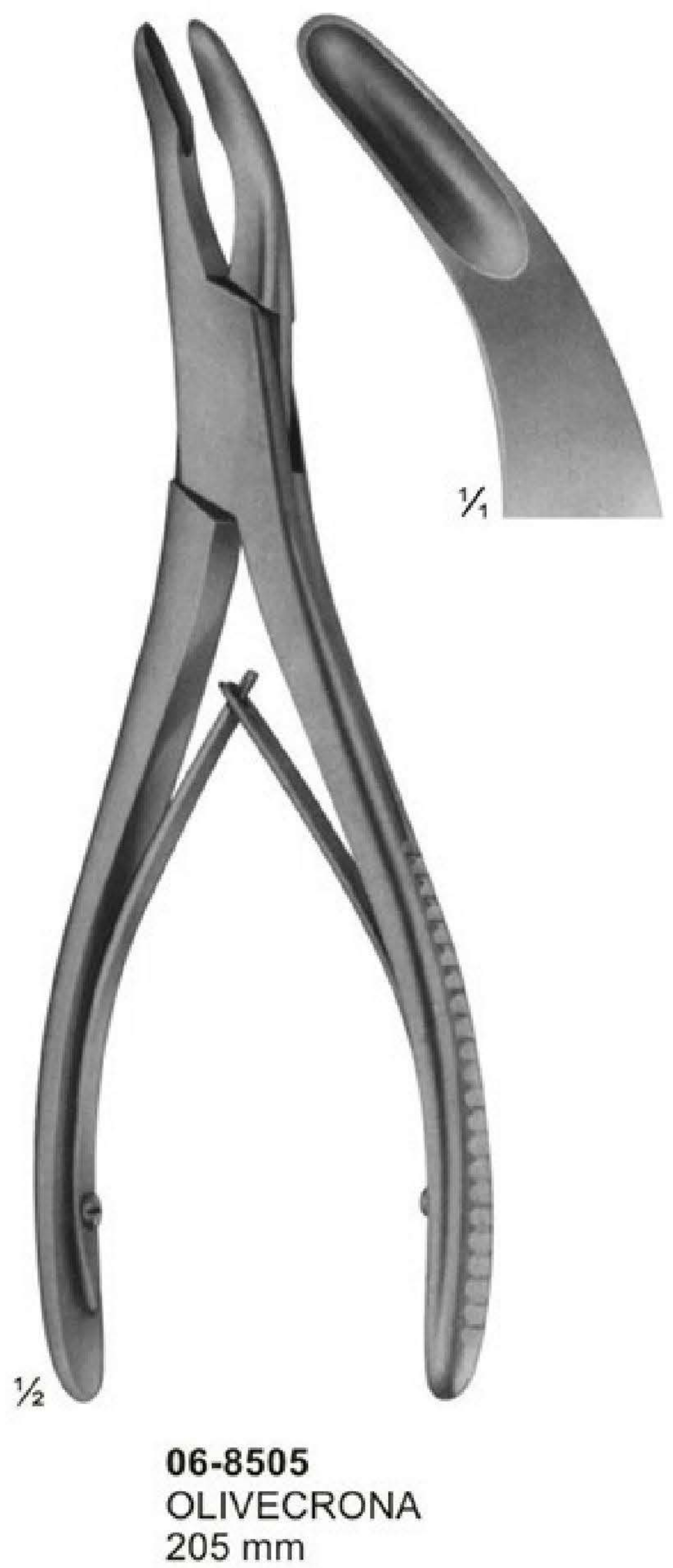
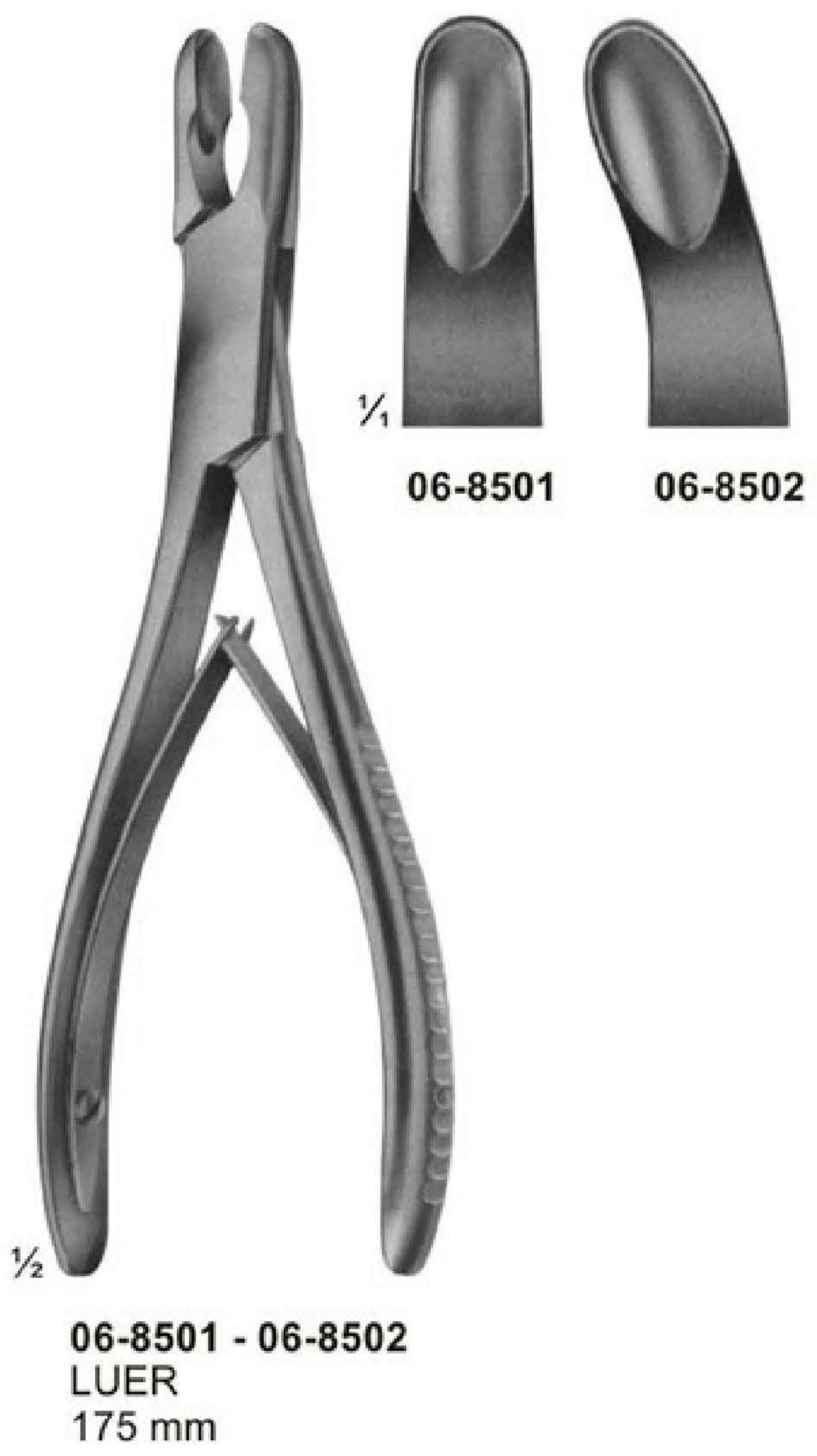

Bone Rongeurs



06-8509
RUSKIN
190 mm



06-8510
ROETTGEN-RUSKIN
240 mm



06-8511 - 06-8512
ECHLIN
230 mm

Bone Rongeurs



06-8513
STILLE
235 mm



06-8514
LEKSELL-STILLE
240mm



06-8515
STILLE-RUSKIN
240mm

Bone Rongeurs



06-8516
LUER-STILLE
225 mm



06-8517
LUER-STILLE
225 mm

Bone Rongeurs



06-8518
LUER-STILLE
270 mm

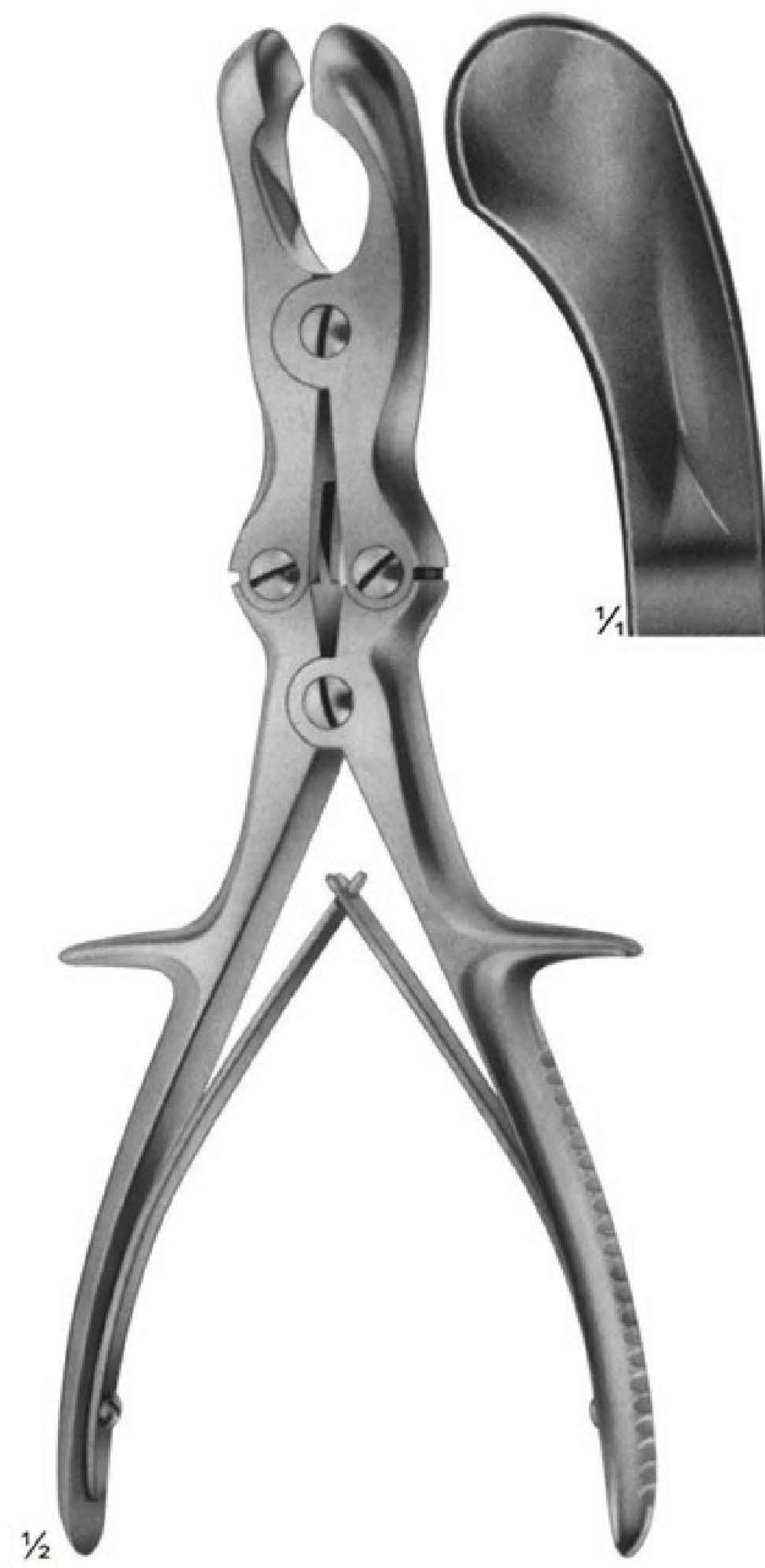

06-8519
SEMB
240 mm

Bone Cutting Forceps

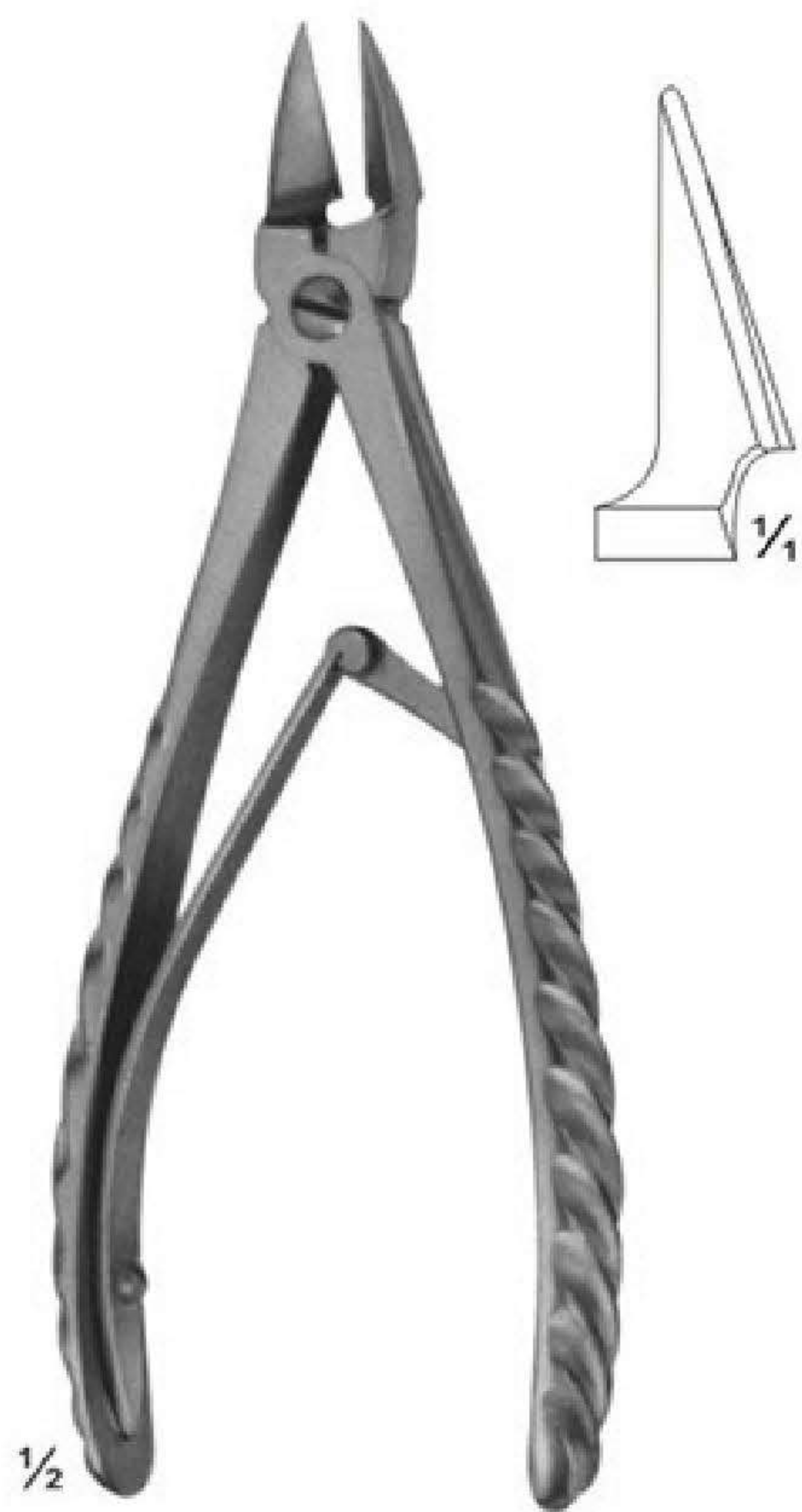

06-8520
STAMM
150 mm



06-8521
KAZANJIAN
185 mm



06-8522 - 06-8525
LISTON



06-8522
140 mm



06-8523
170 mm



06-8524
200 mm



06-8525
220 mm

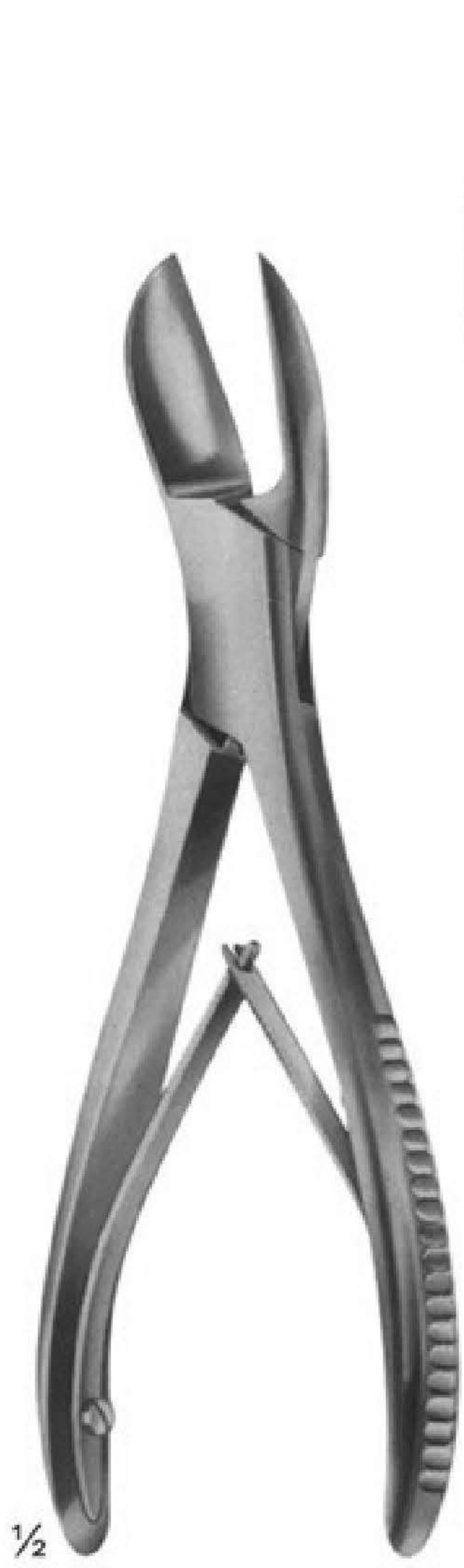

06-8526 - 06-8528
LISTON



06-8526
170 mm

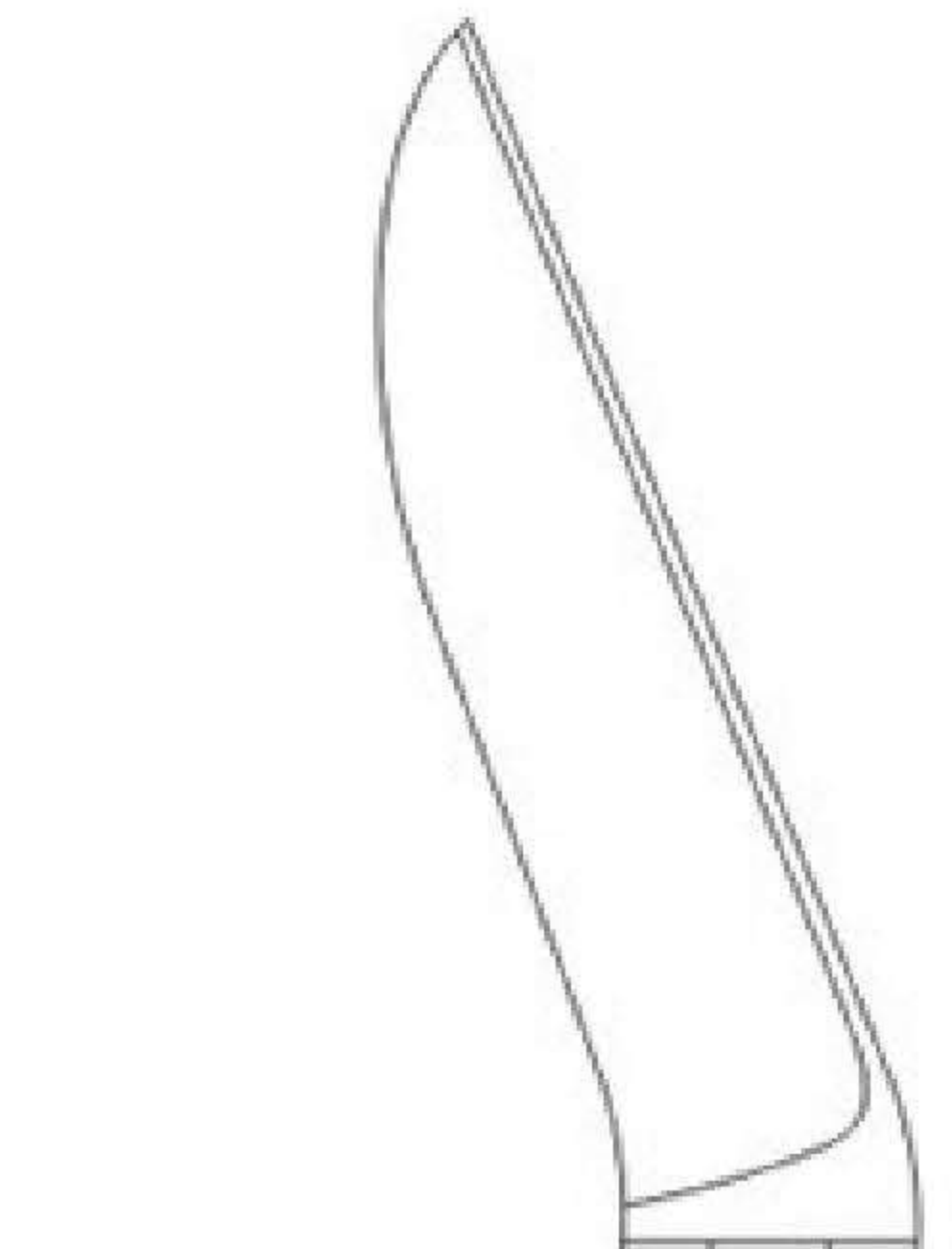

06-8527
200 mm

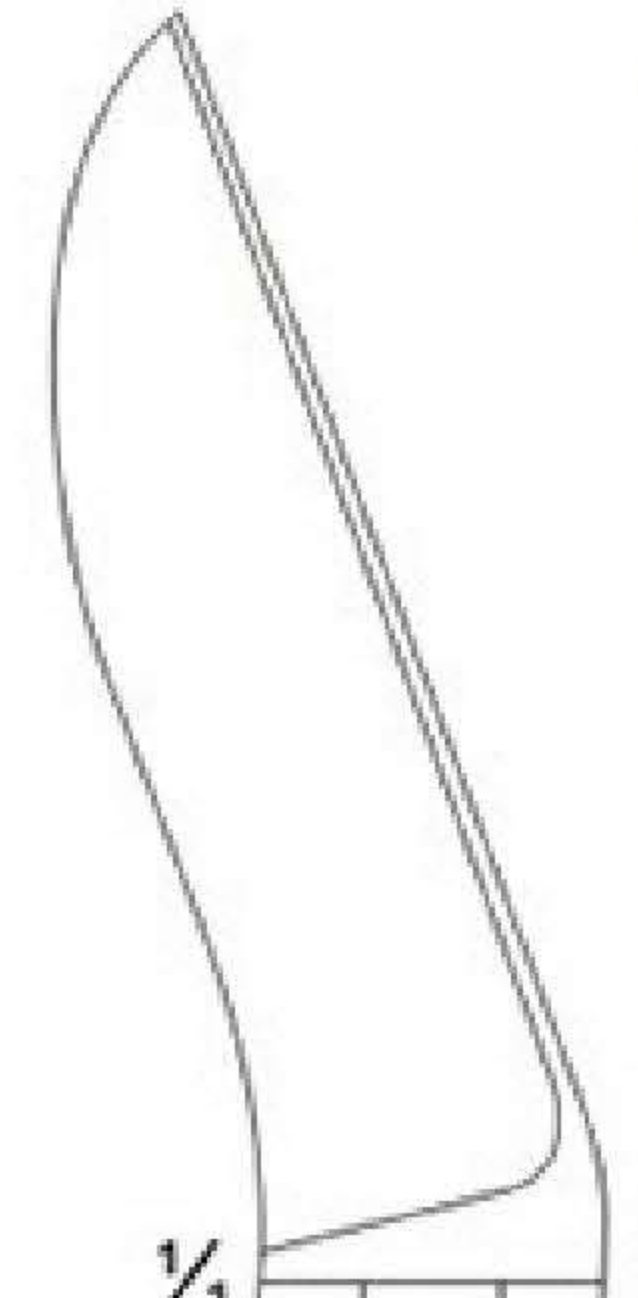

06-8528
220 mm

Bone Cutting Forceps



06-8529
BOEHLER
145 mm



06-8530
RUSKIN-LISTON
190 mm



06-8531
RUSKIN-LISTON
190 mm

Bone Cutting Forceps

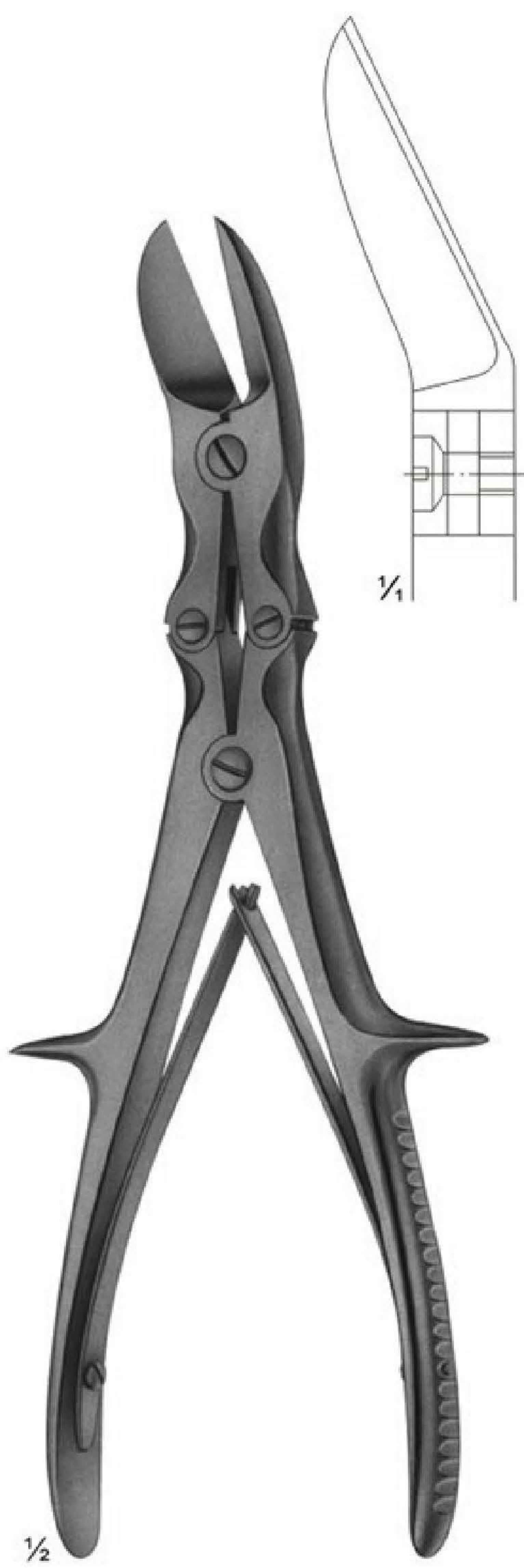

06-8532
LISTON
curved on flat
240 mm

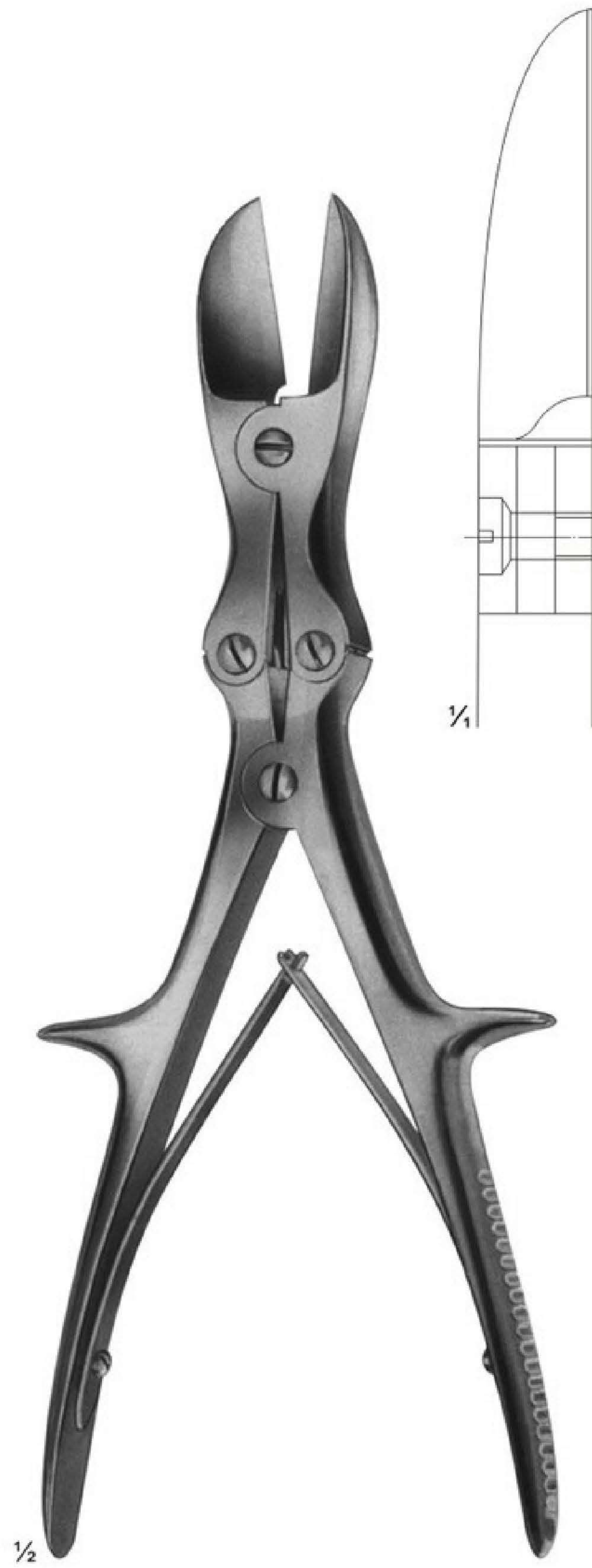

06-8533
LISTON
straight
280 mm

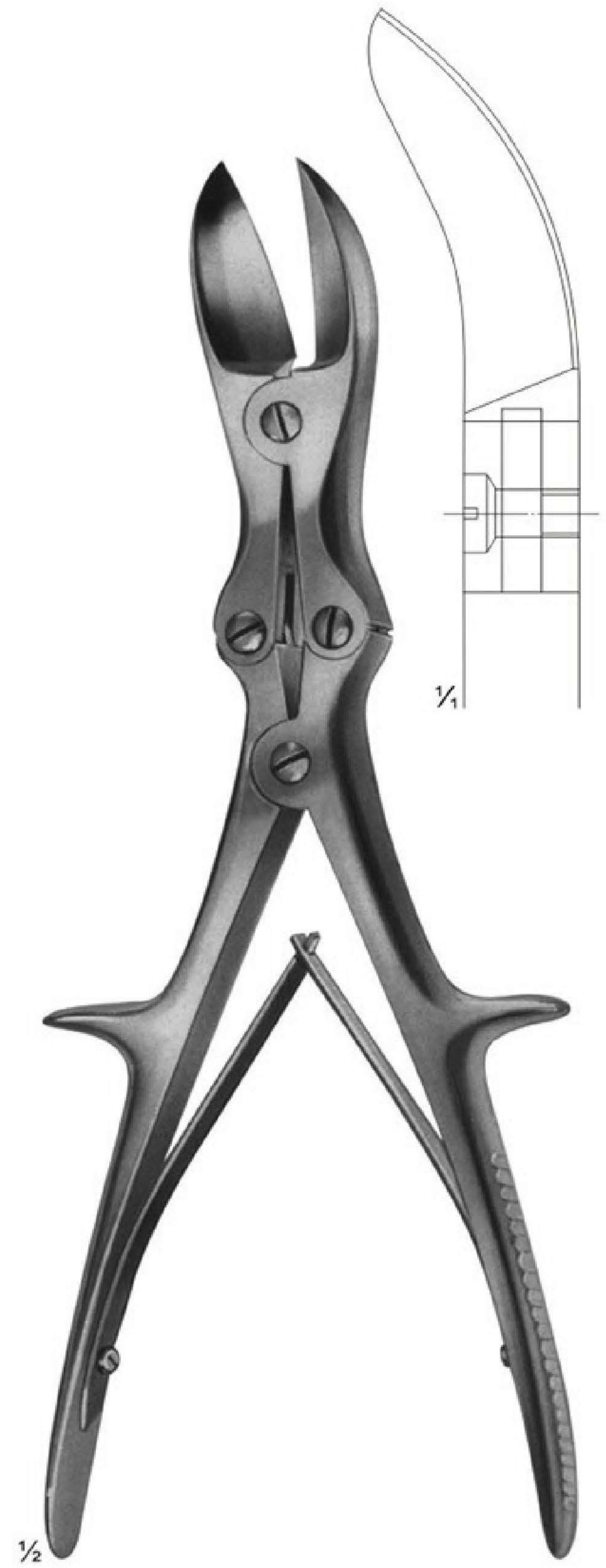

06-8534
LISTON
curved on flat
280 mm

Bone Cutting Forceps

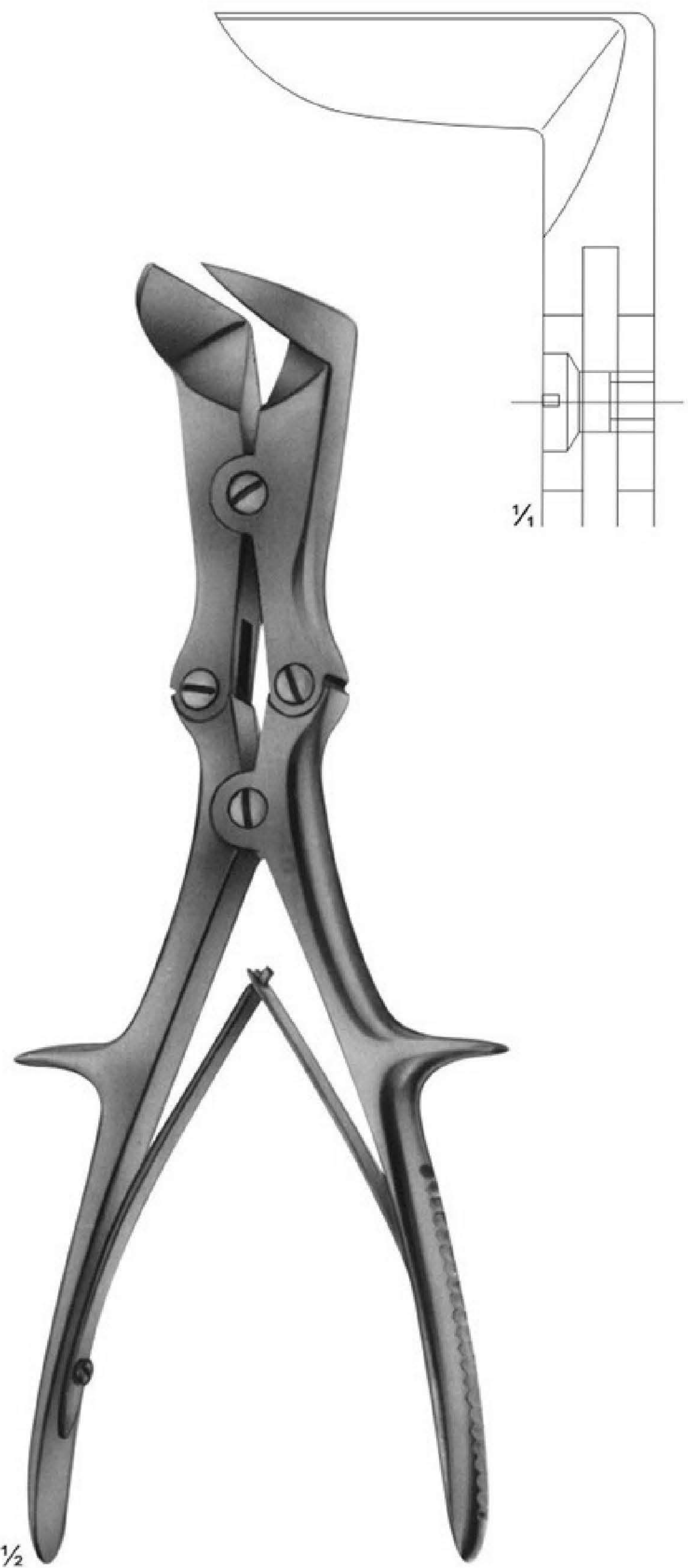

06-8535
LISTON-STILLE
265 mm

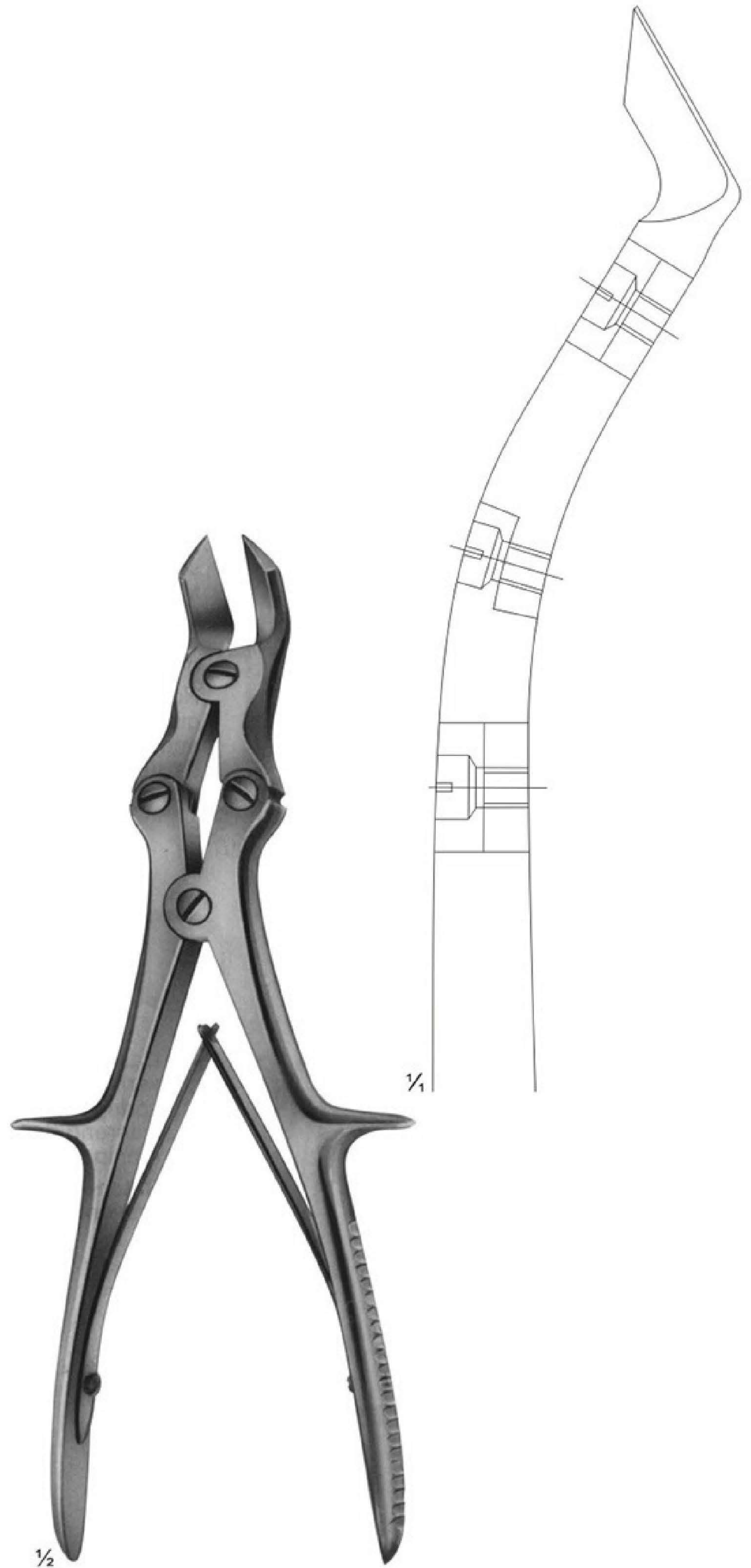

06-8536
LISTON-KEY-HORSLEY
(TUDOR EDWARDS)
255 mm

Meniscus-and Cartilage Forceps

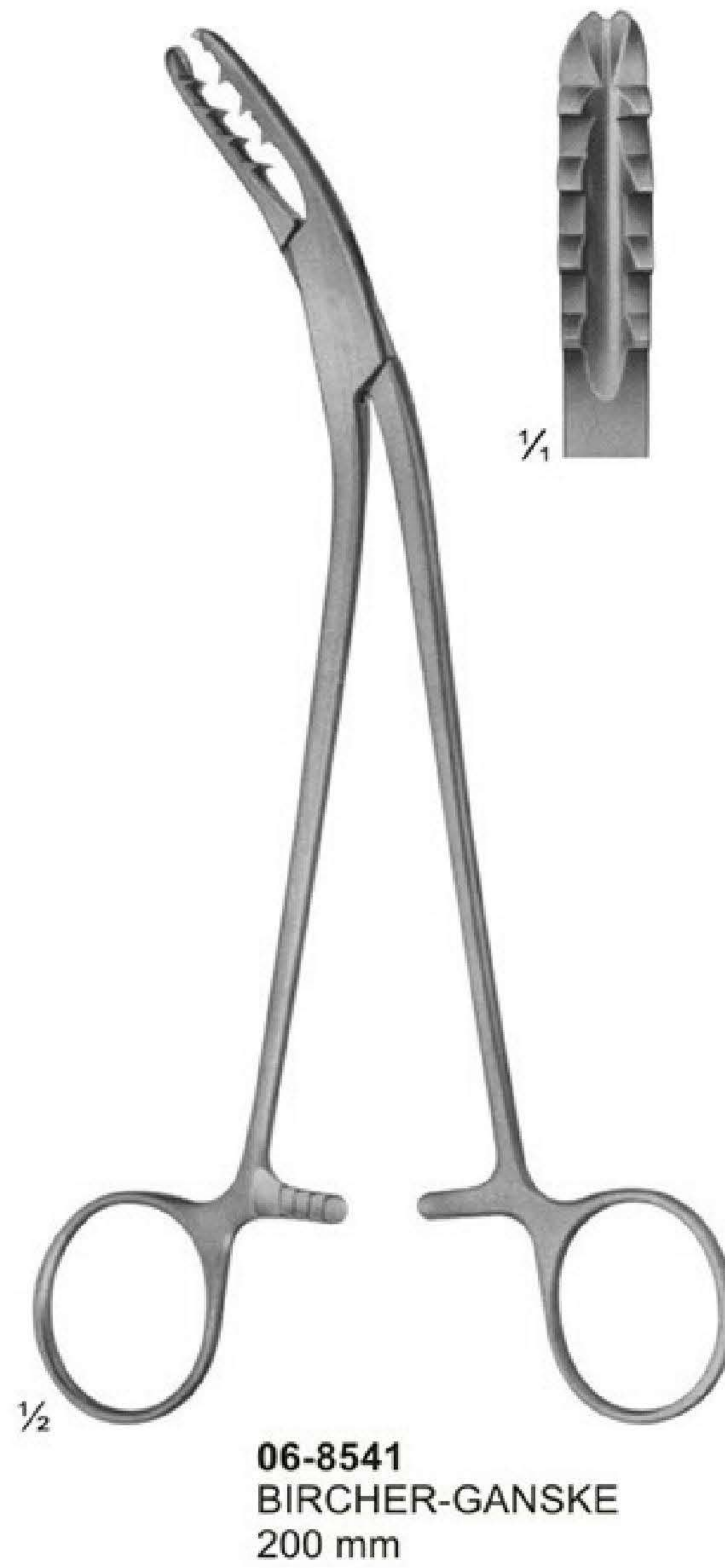
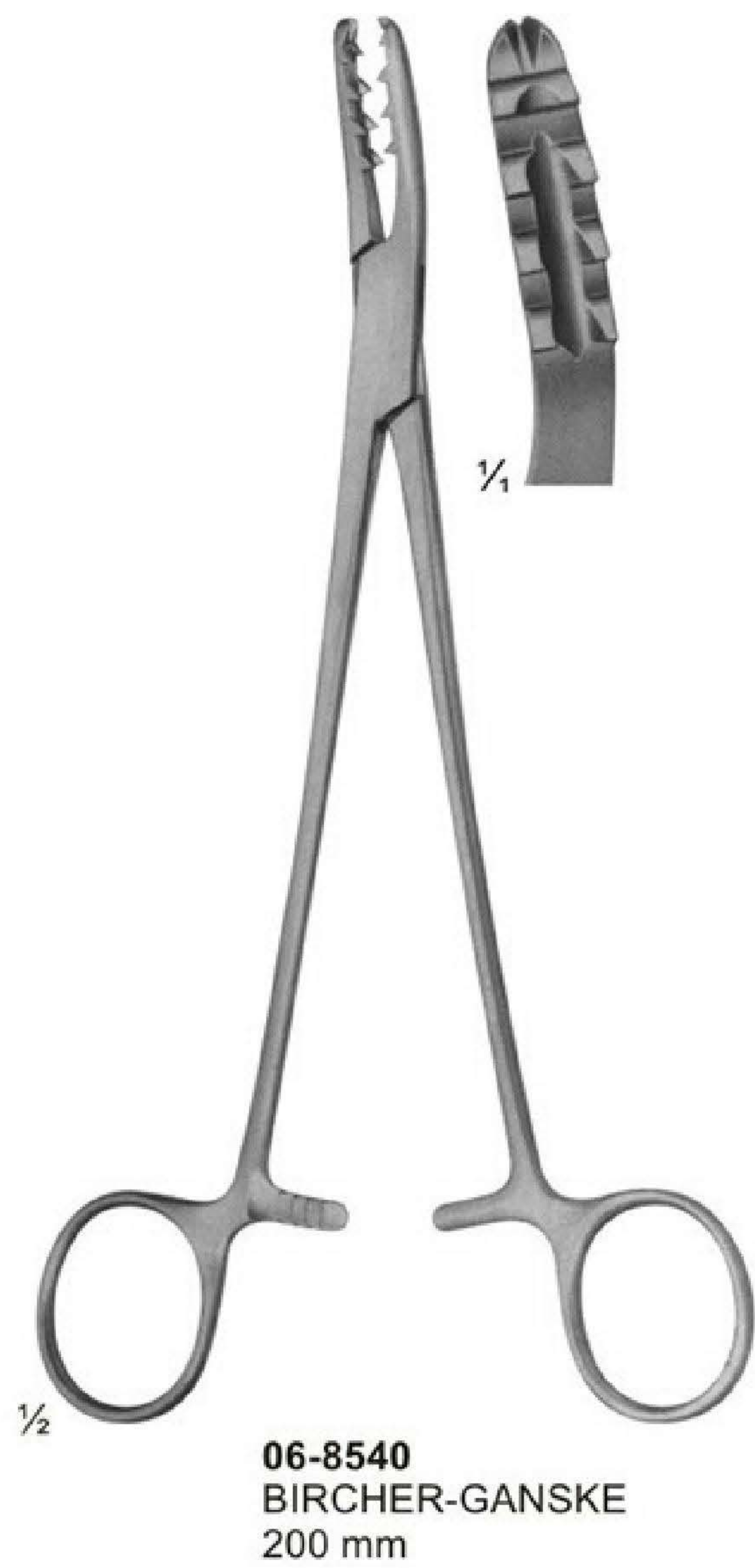
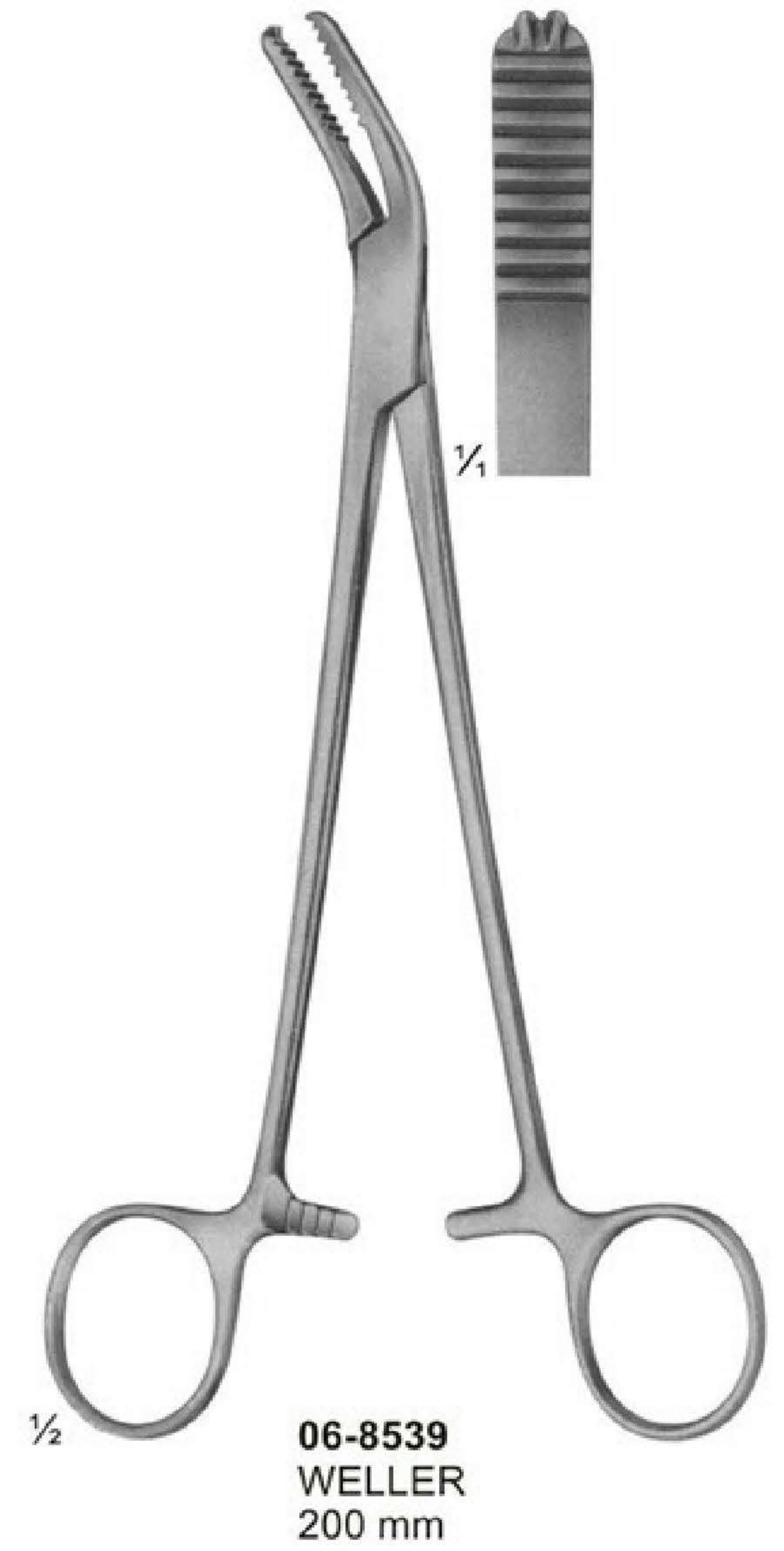

Meniscus Knives

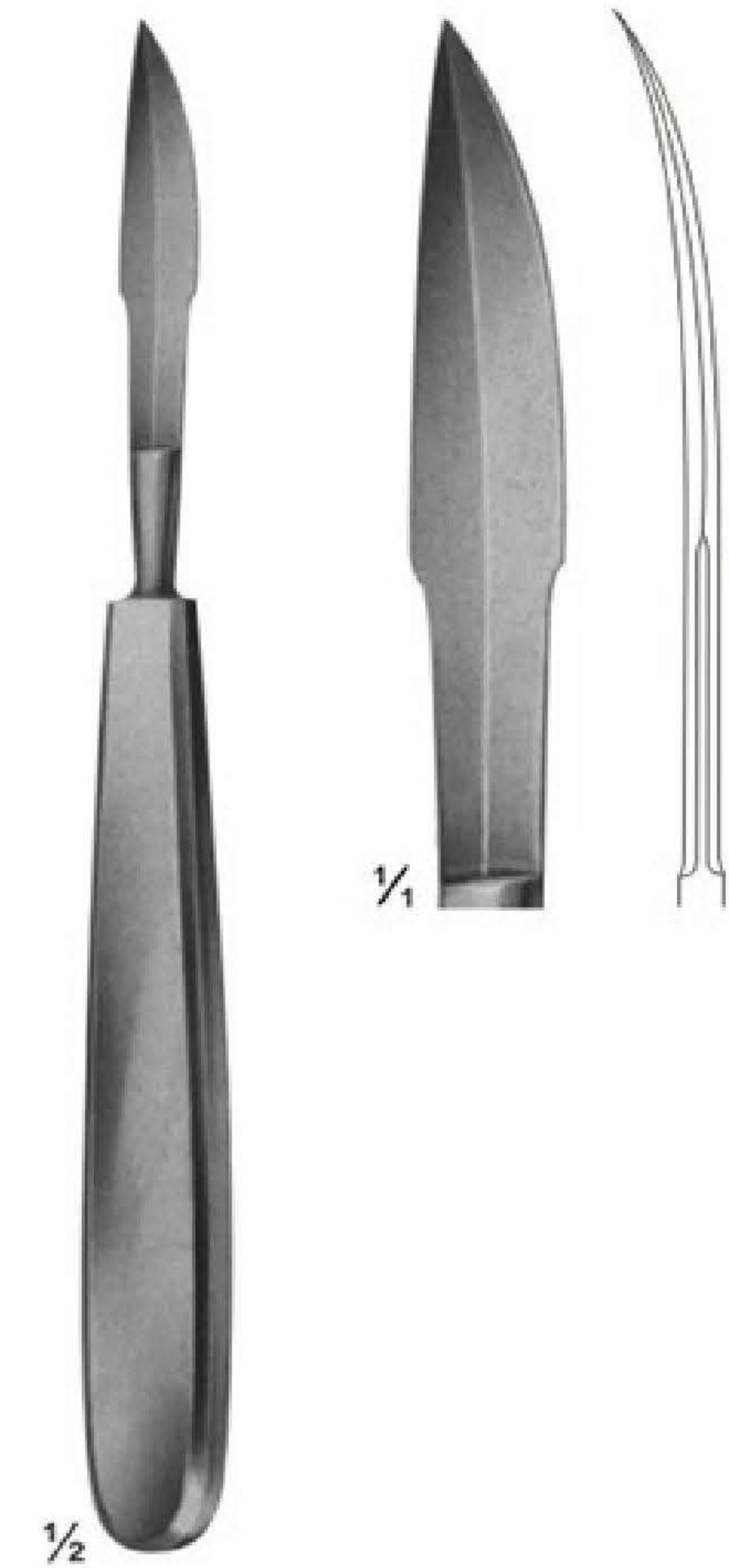

$\frac{1}{2}$
06-8543
 170 mm

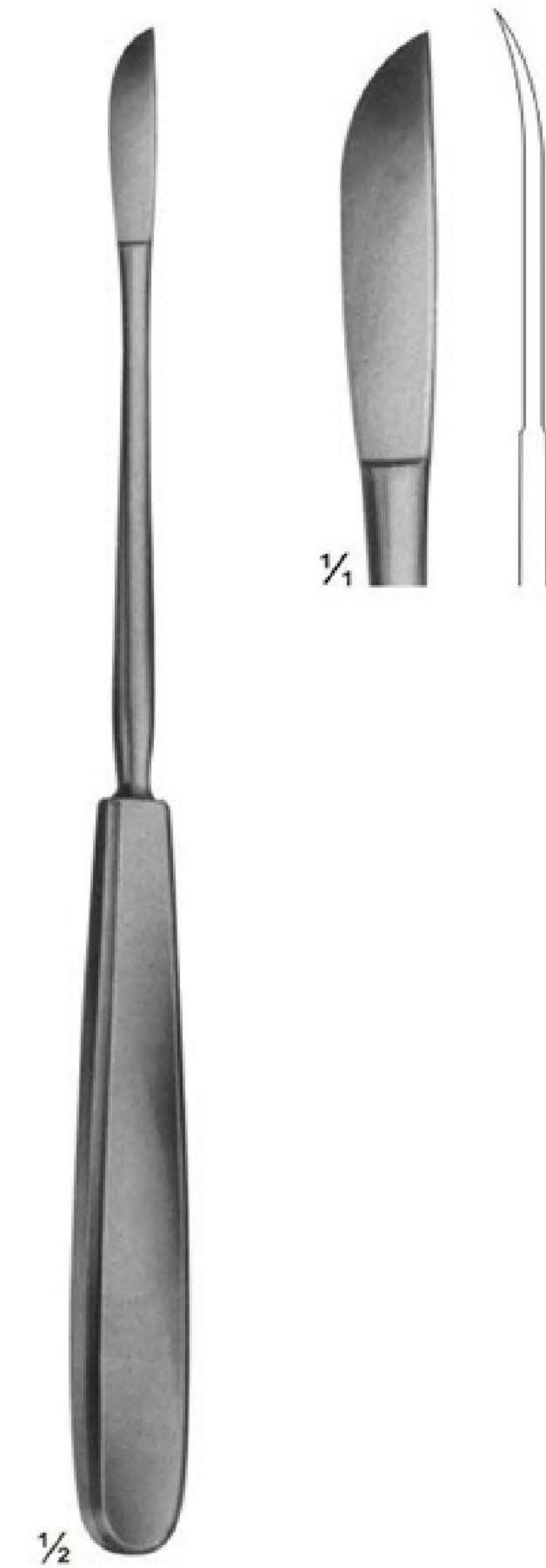

$\frac{1}{2}$
06-8544
 NEFF
 215 mm



$\frac{1}{2}$
06-8545
 NEFF
 215 mm



$\frac{1}{2}$
06-8546
 WAGNER
 215 mm

Meniscus Knives

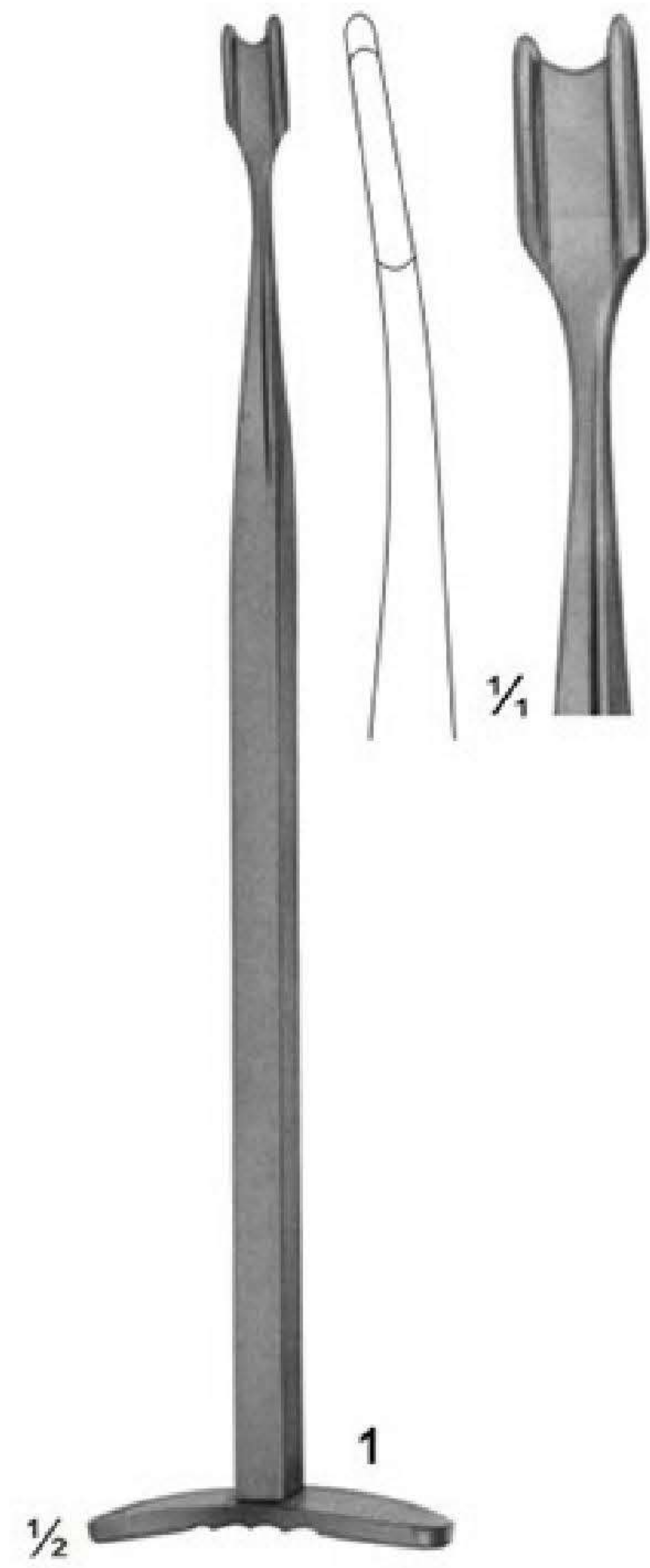

06-8547
 SMILLIE
 170 mm

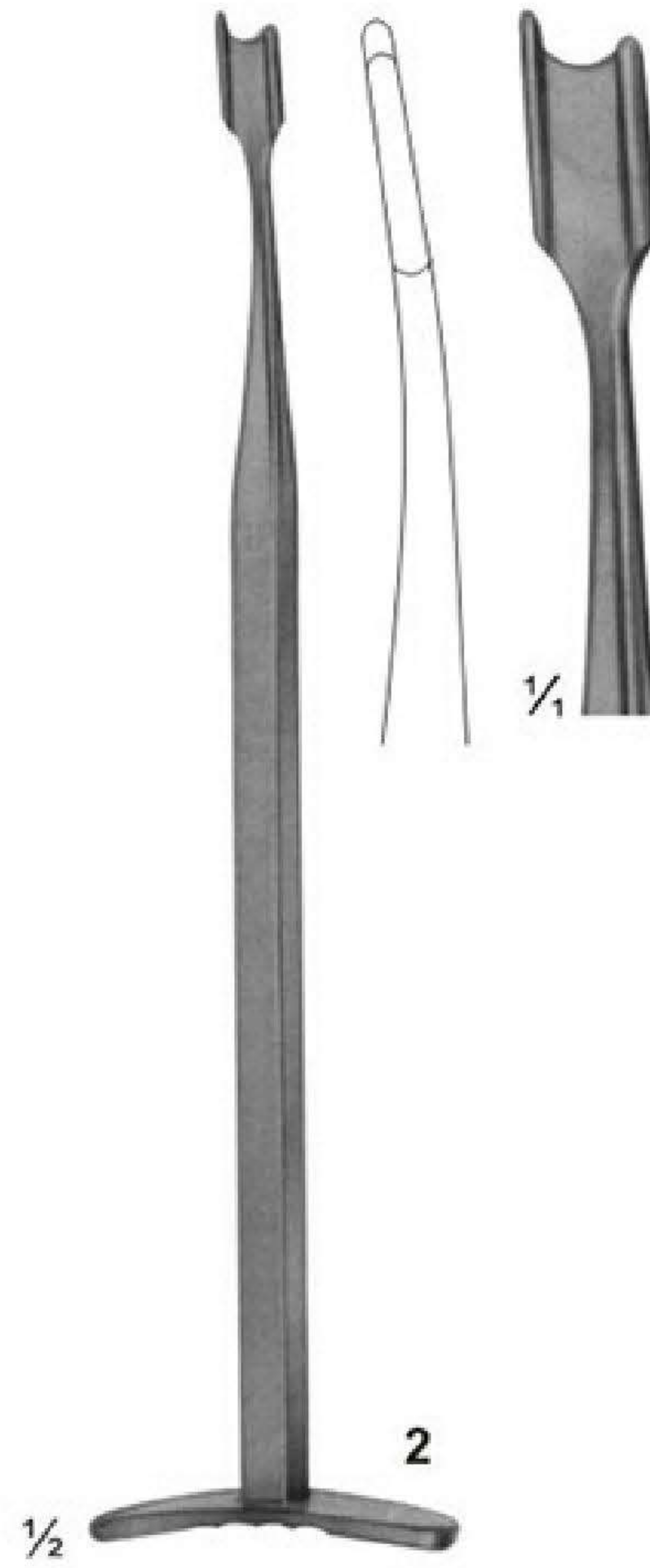

06-8548
 SMILLIE
 170 mm

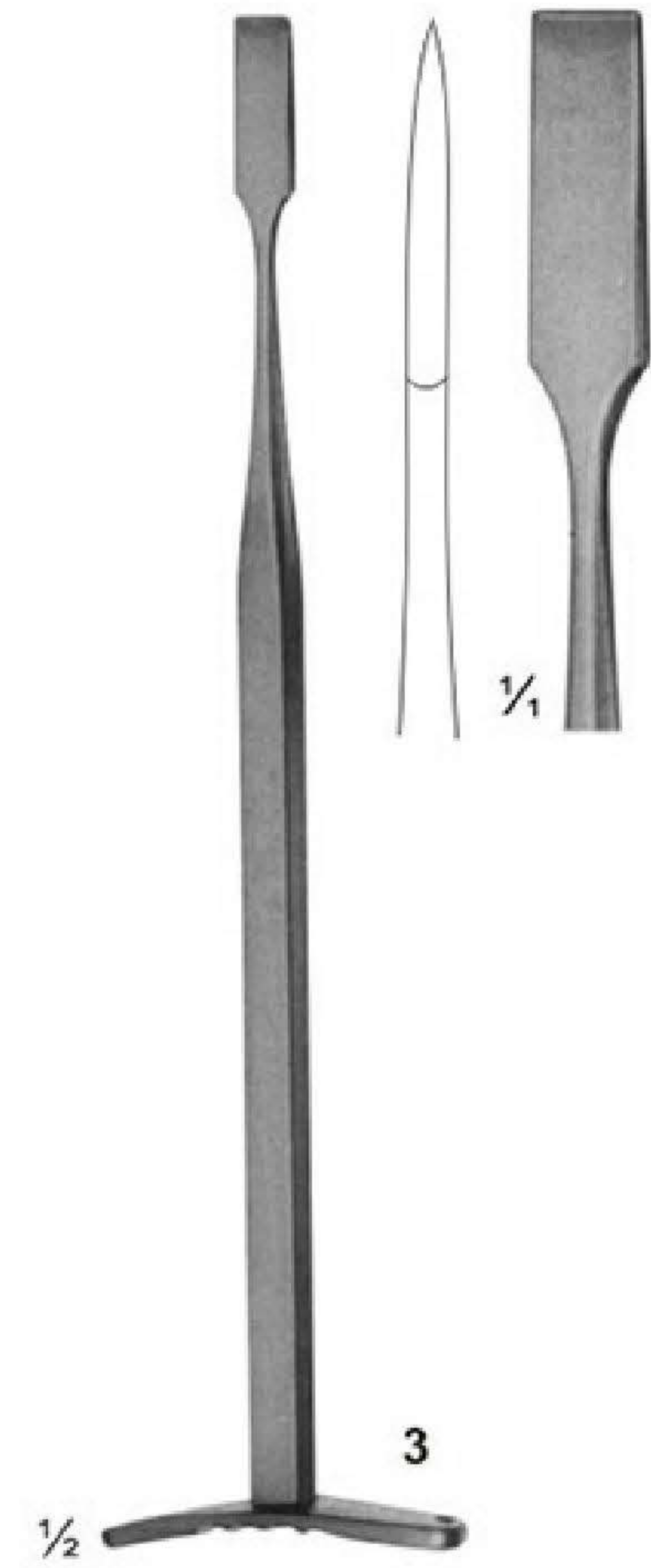

06-8549
 SMILLIE
 170 mm

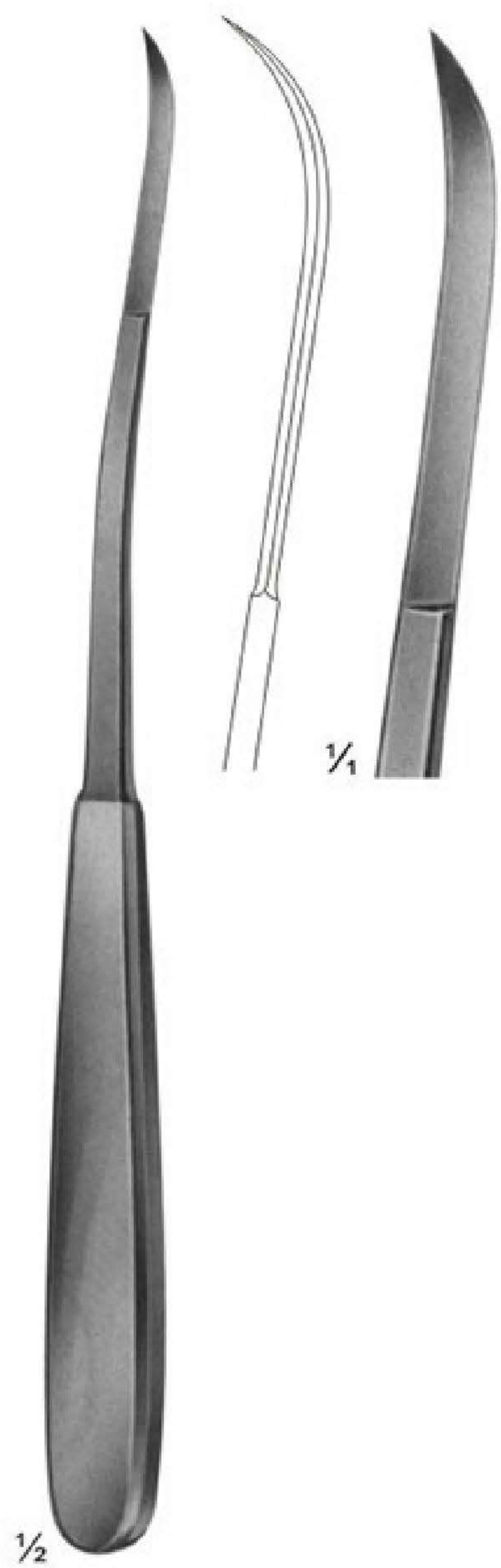

06-8550
 SALENIUS
 220 mm

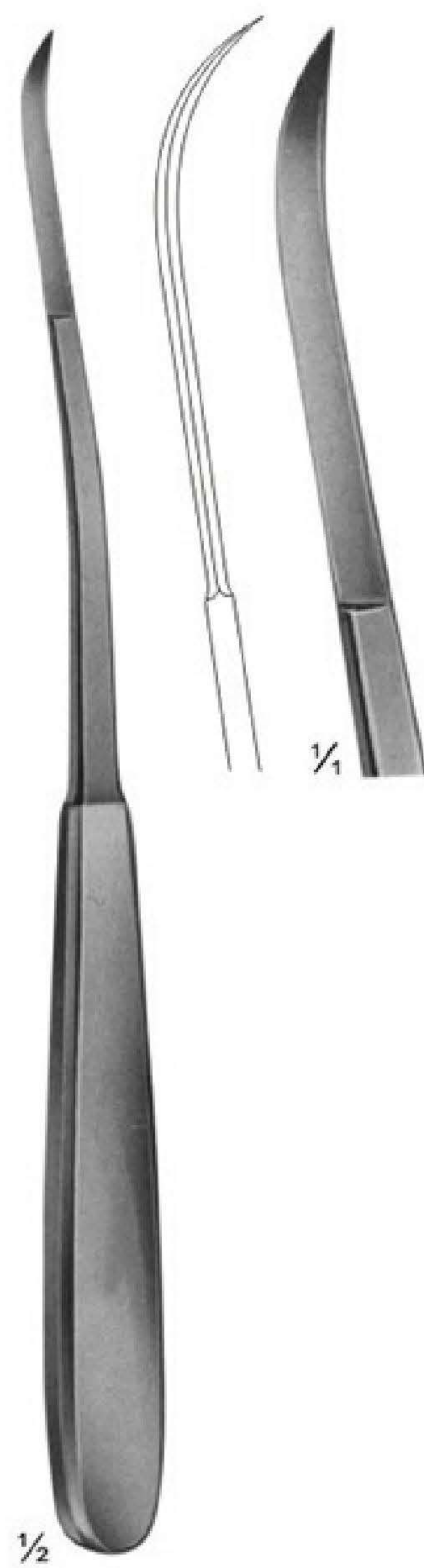

06-8551
 SALENIUS
 220 mm

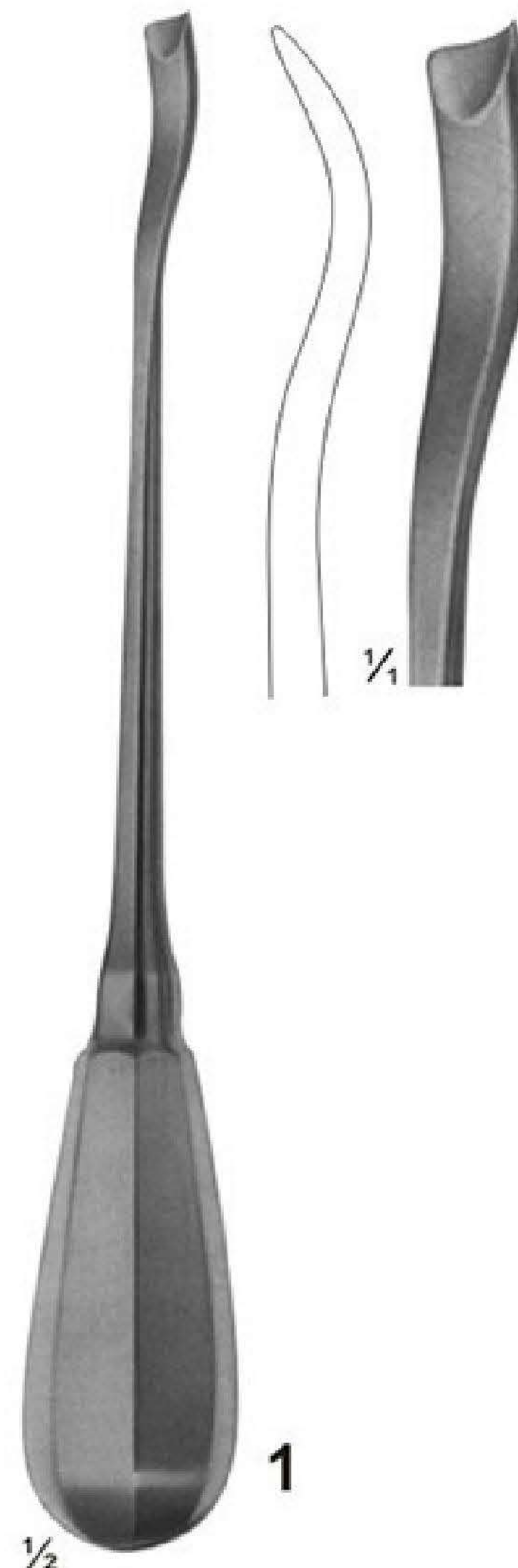

06-8552
 CANAD. MODELL
 200 mm

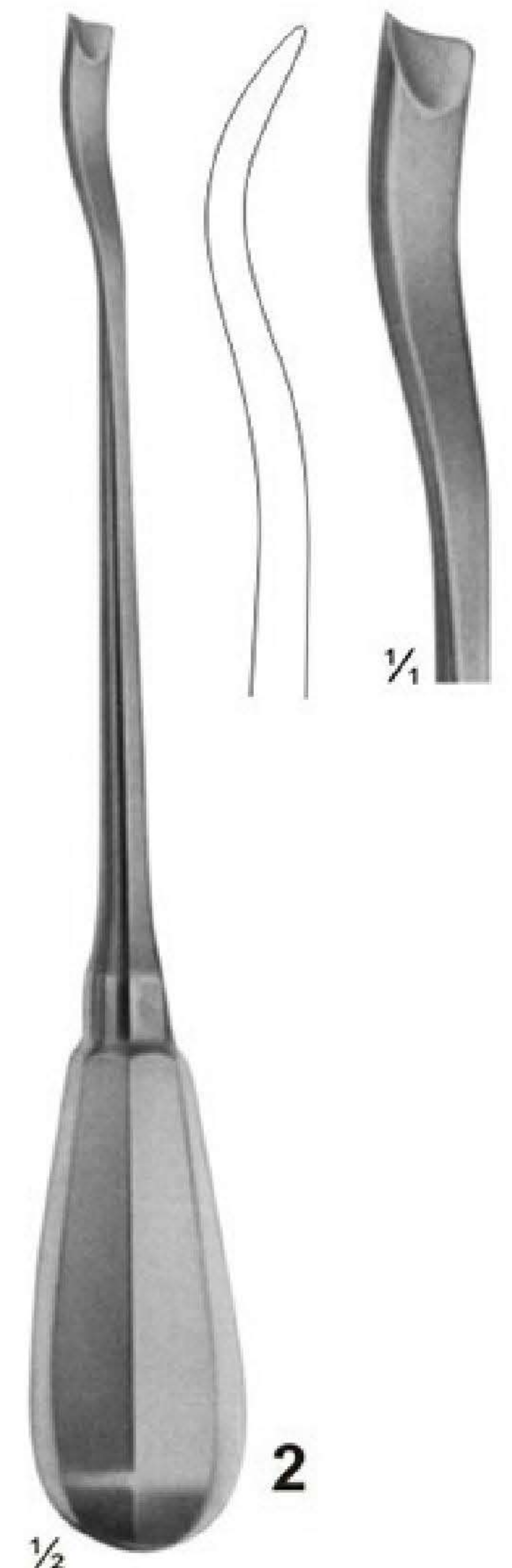

06-8553
 CANAD. MODELL
 200 mm