

Micro Scissors, "Spring Type" Flat Handles

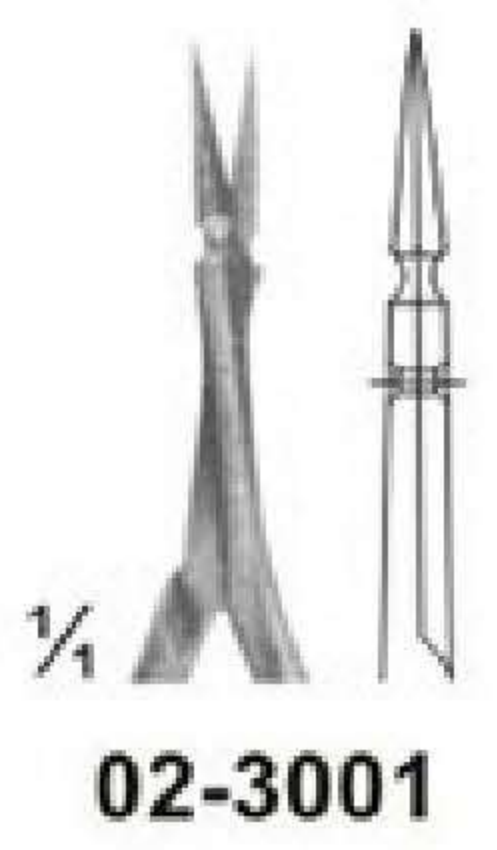

02-3001

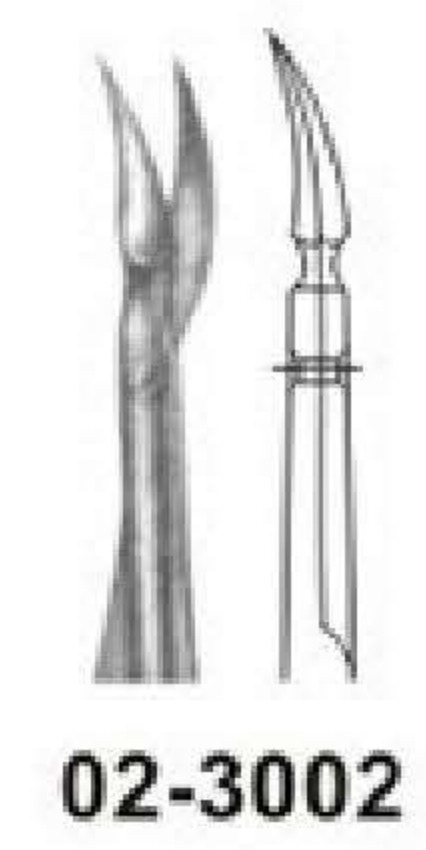

02-3002



02-3003

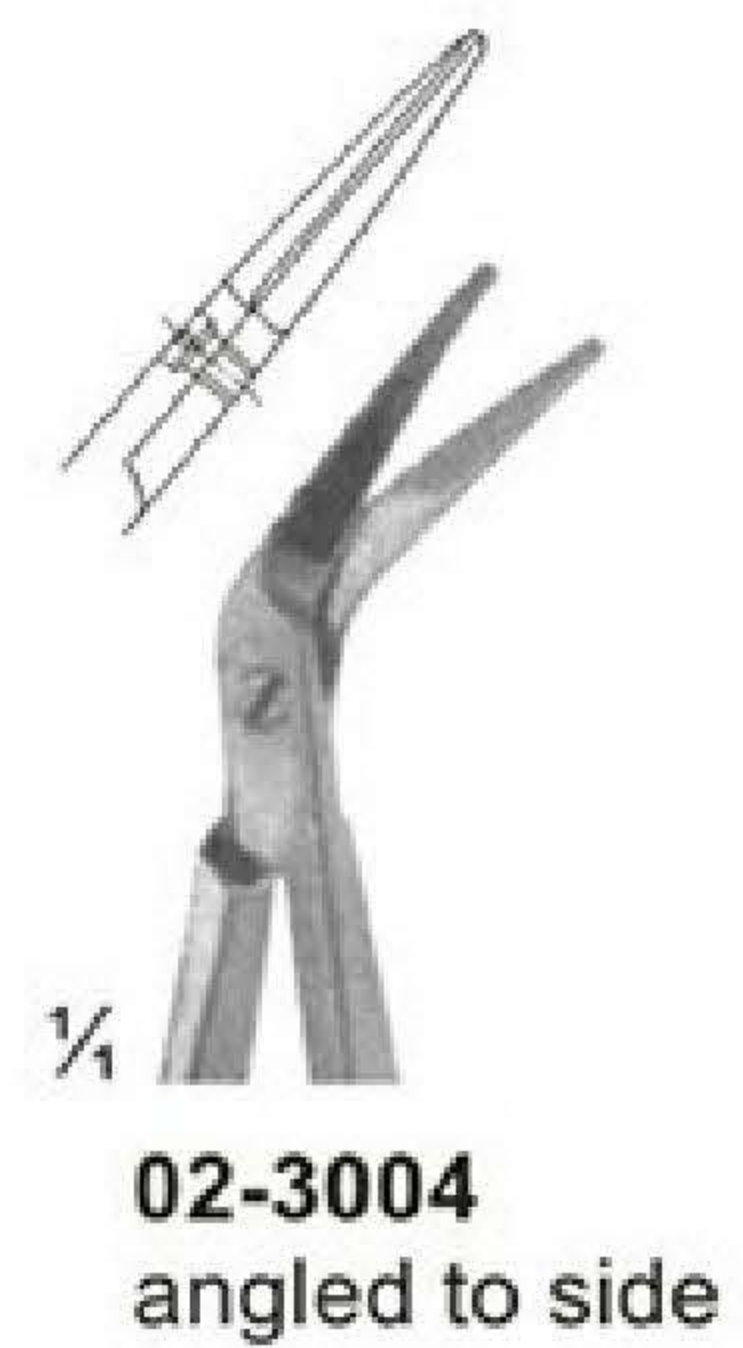

02-3004
 angled to side

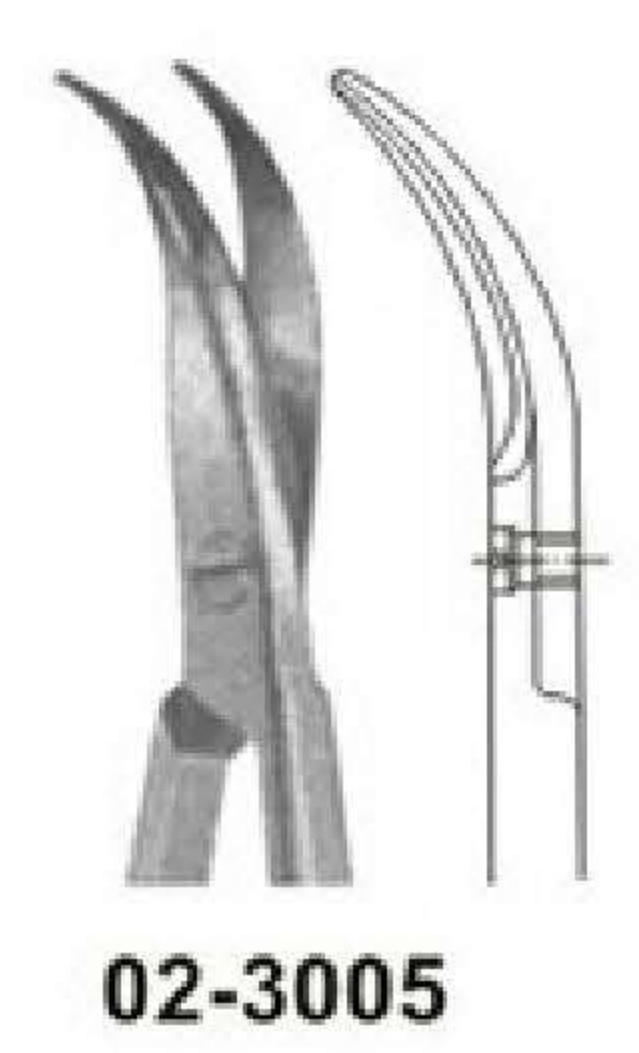

02-3005

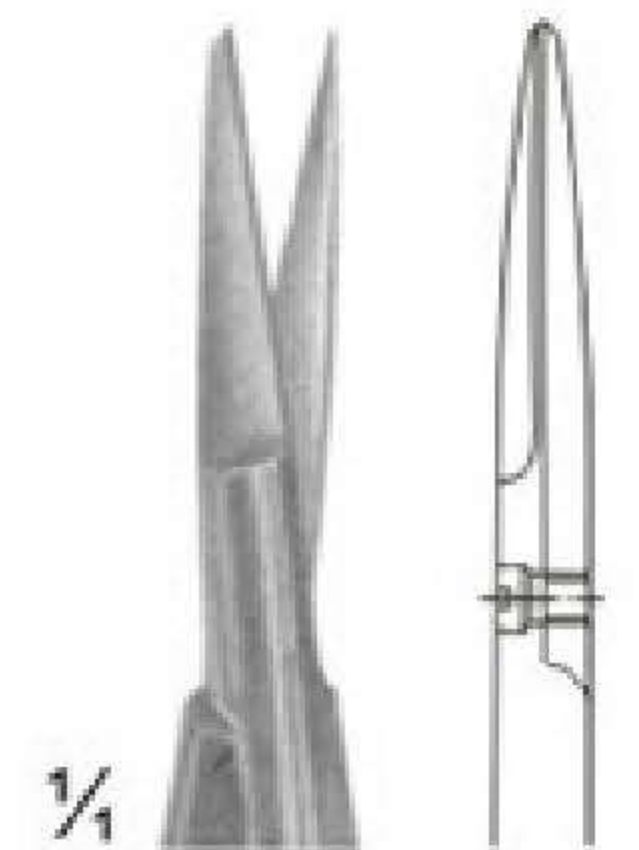
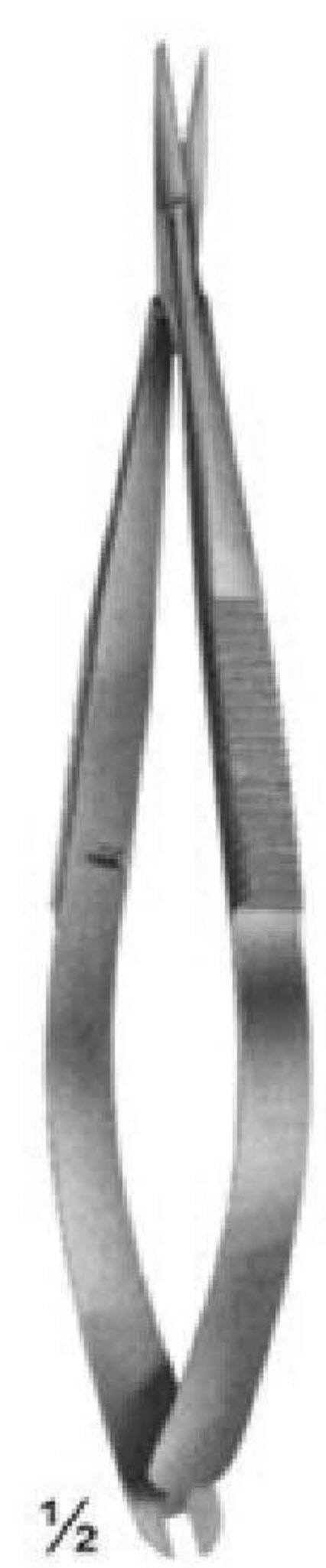

02-3006
 NOYES
 Size: 125 mm

02-3001 - 02-3003
 VANNAS
 Size: 85 mm

02-3004 - 02-3005
 CASTROVIEJO
 Size: 95 mm

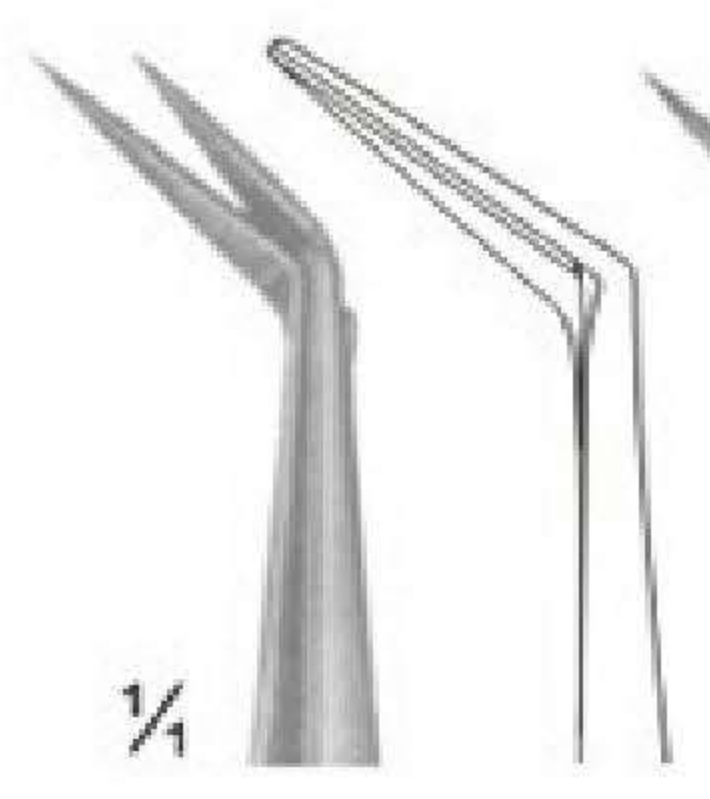
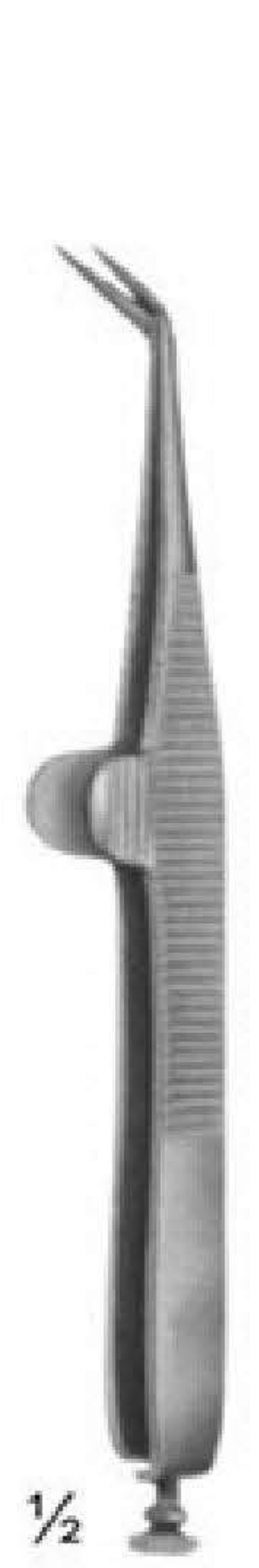

02-3007

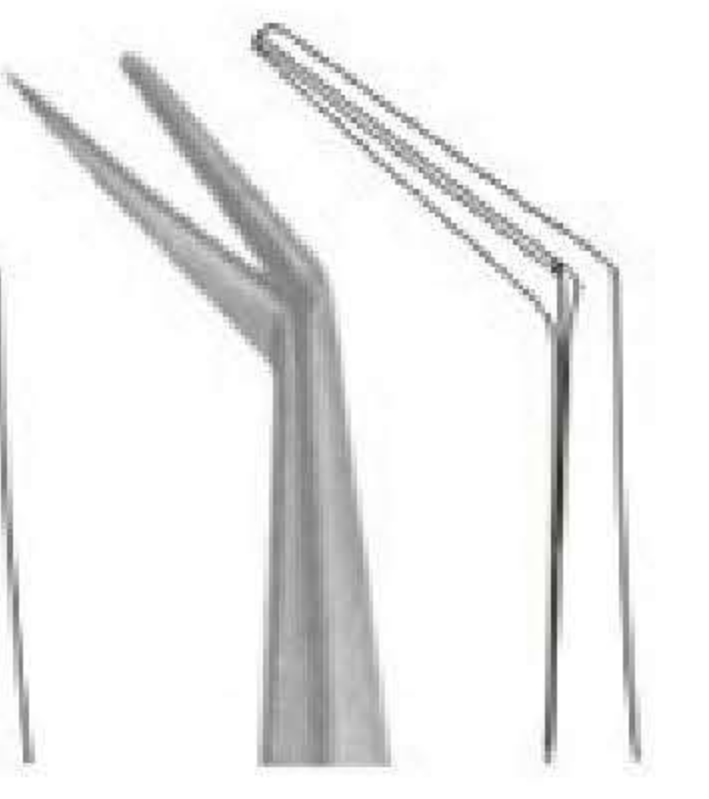

02-3008

02-3007 - 02-3008
 WECKER
 Eye Scissor
 Size: 110 mm

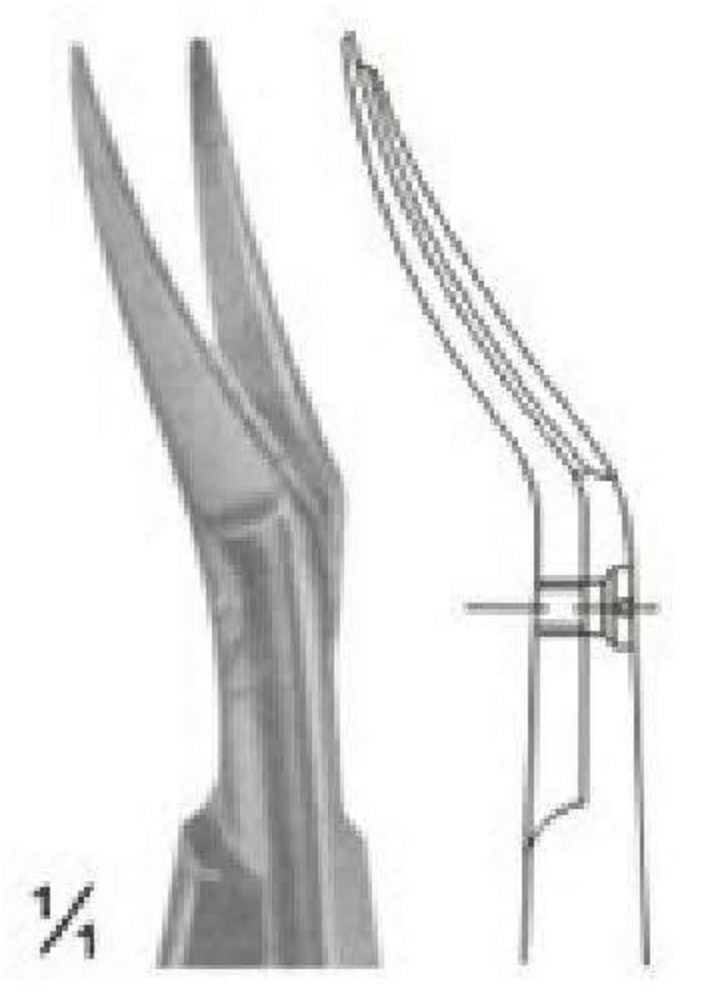
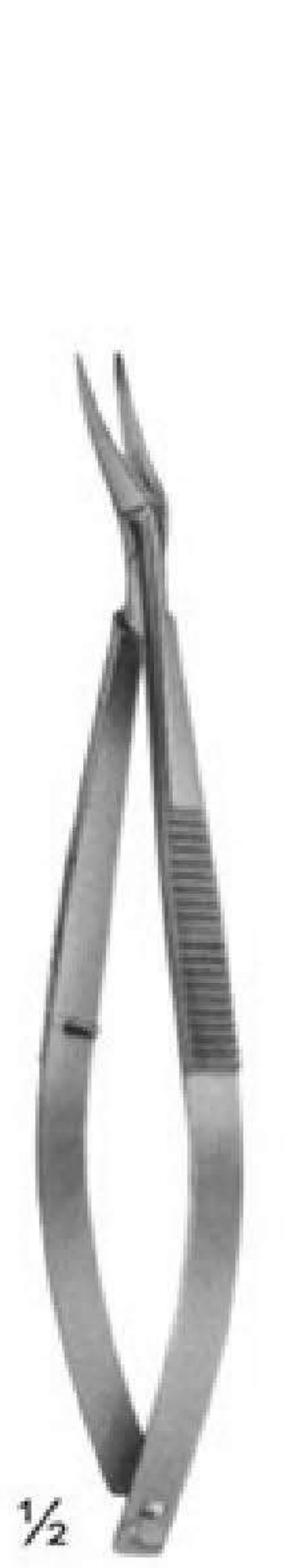

02-3009
 CASTROVIEJO
 Eye Scissor
 Size: 115 mm

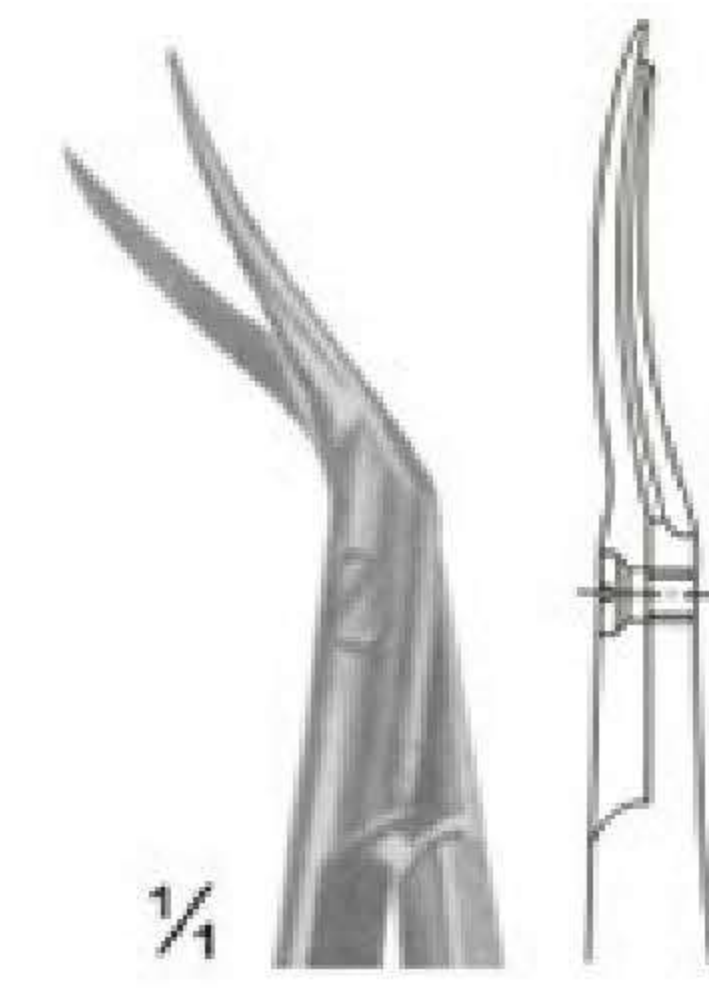

02-3010

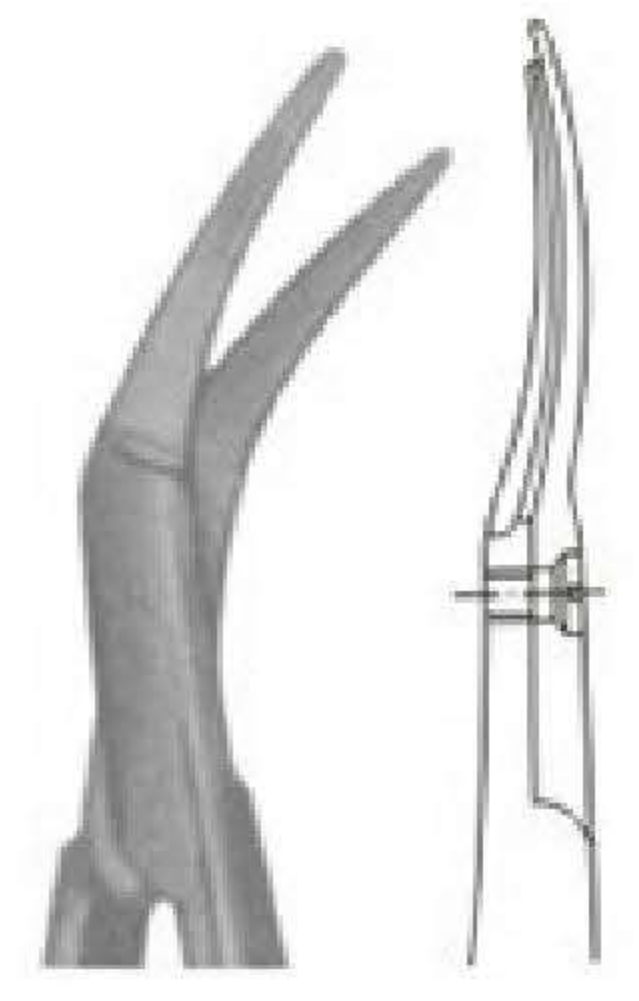

02-3011

02-3010 - 02-3011
 CASTROVIEJO
 Eye Scissor
 Size: 110 mm

Micro Scissors, "Spring Type" Flat Handles and Cross-Serration

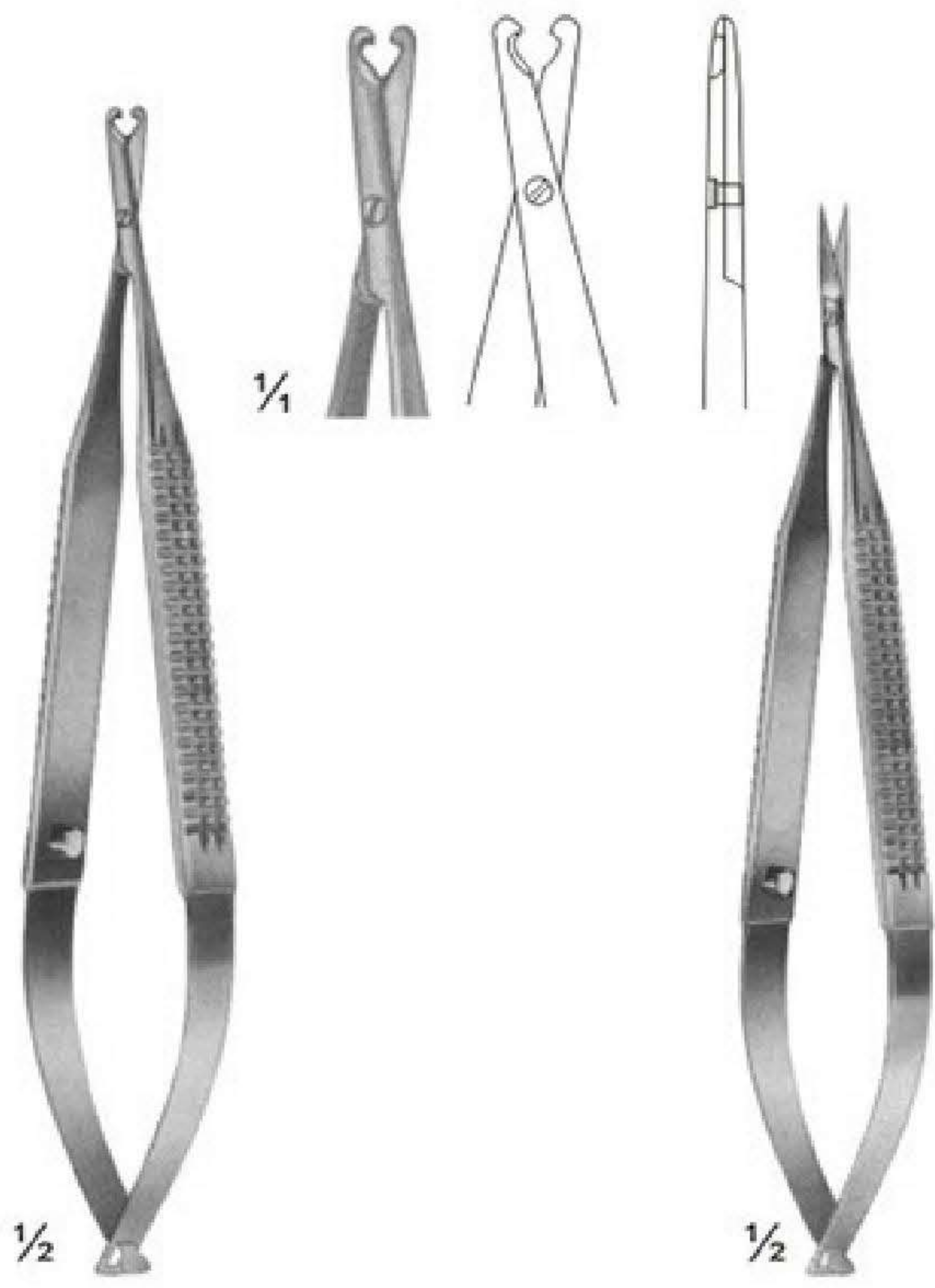

02-3012
 BIEMER
 Vein Scissor
 Size: 130 mm

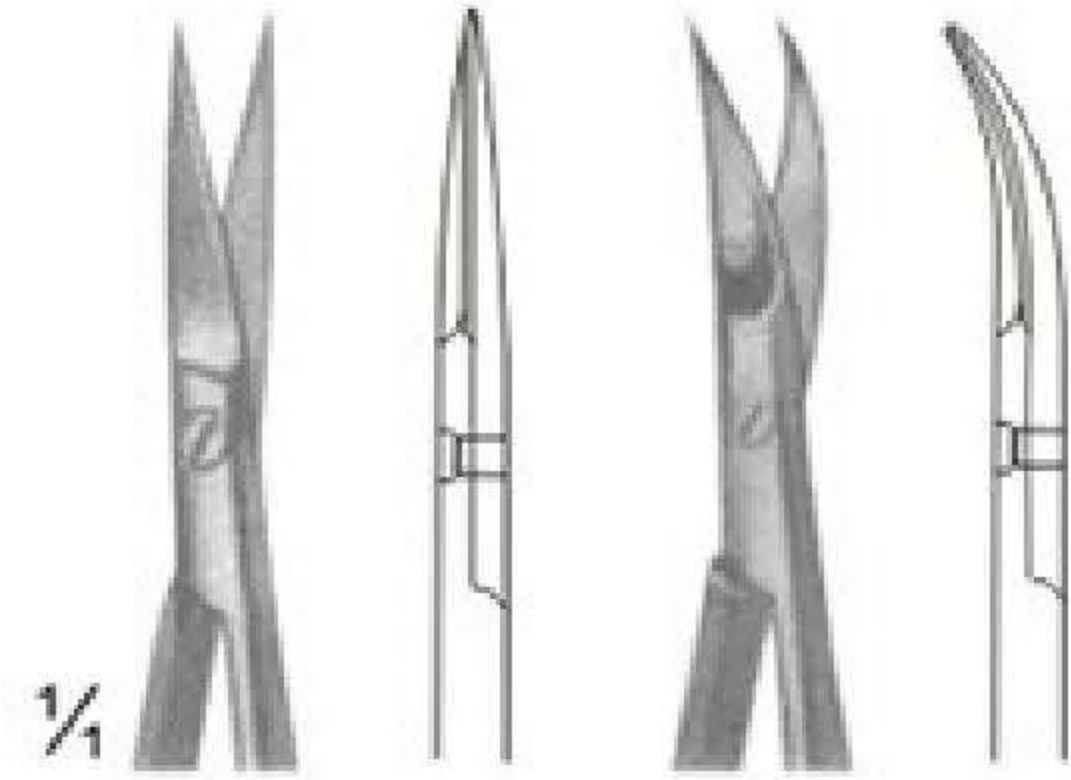
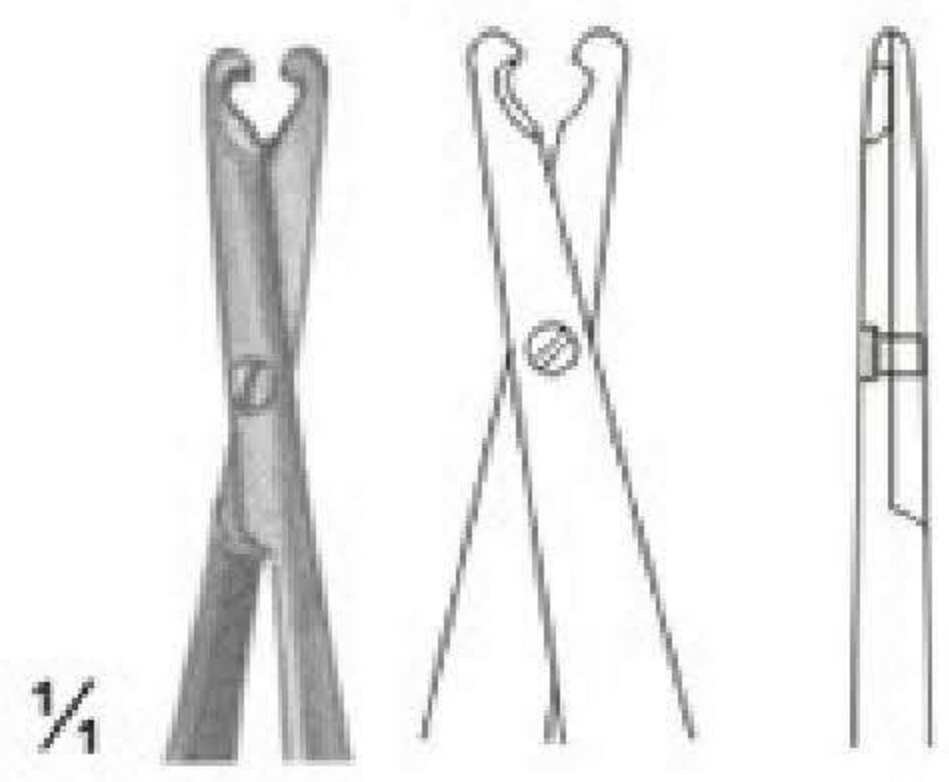

02-3013 **02-3014**

02-3013 - 02-3014
 Size: 120 mm



02-3015

02-3016

02-3015 - 02-3016
 Size: 160 mm

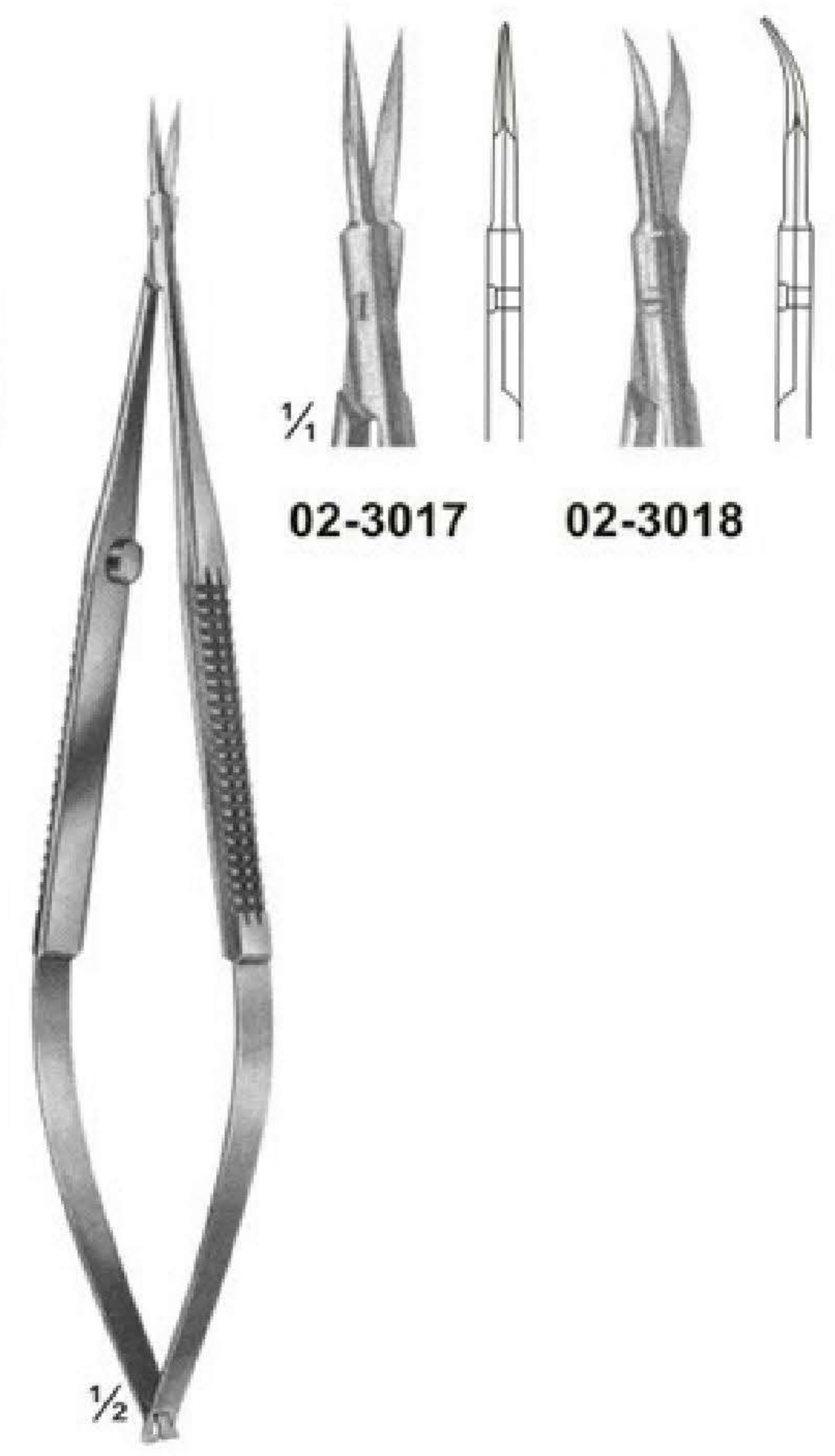
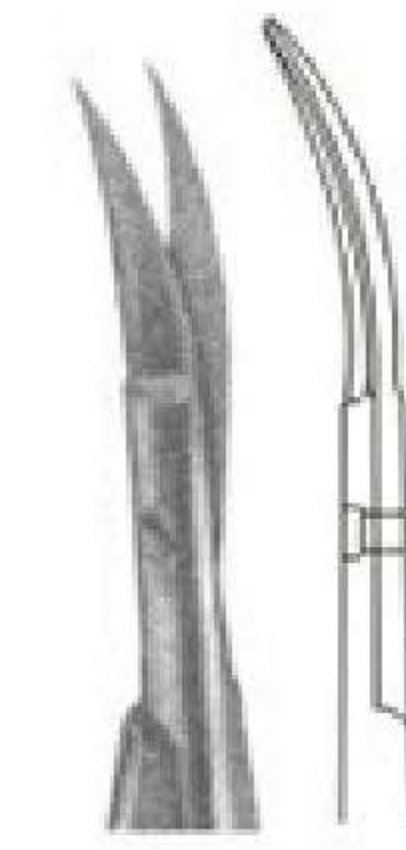

02-3017

02-3018

02-3017 - 02-3018
 VANNAS
 Size: 160 mm

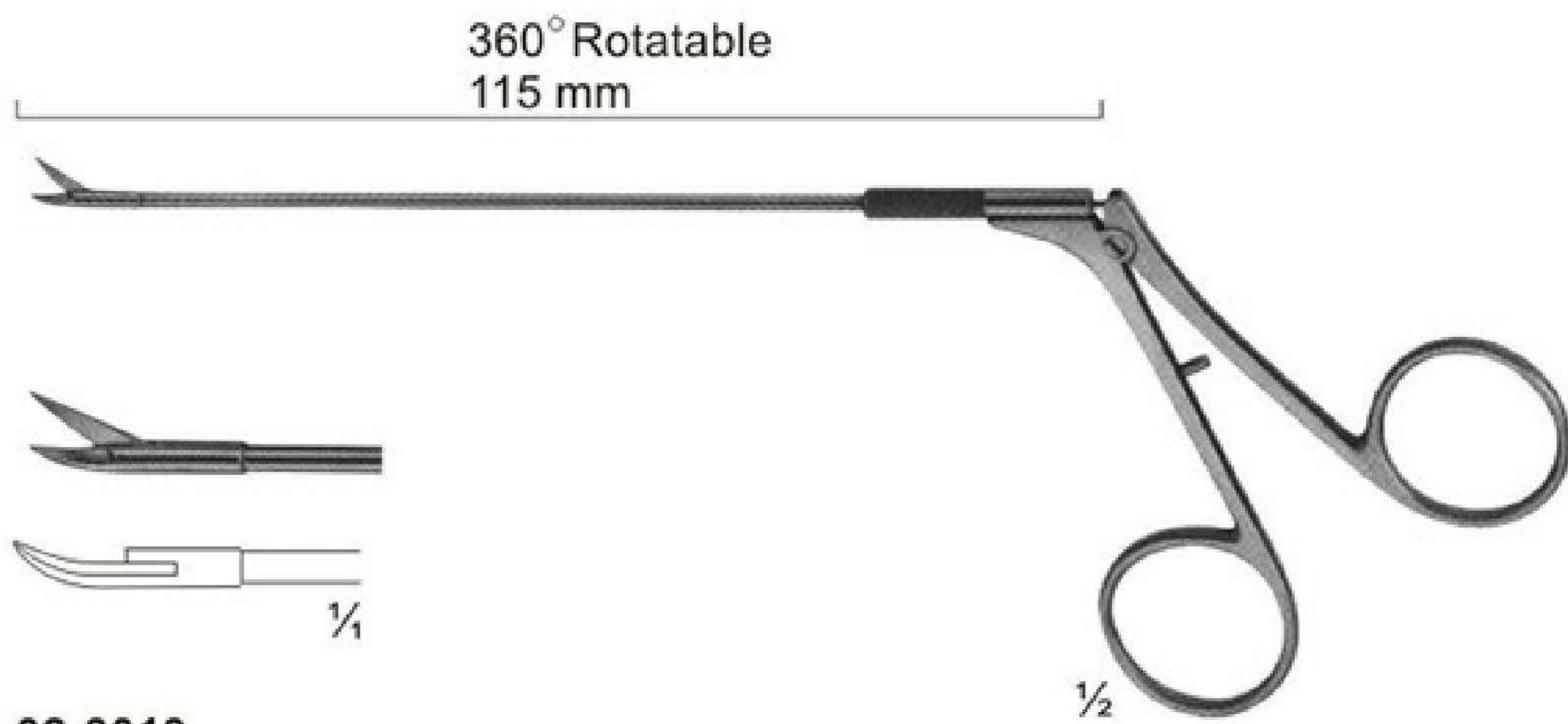
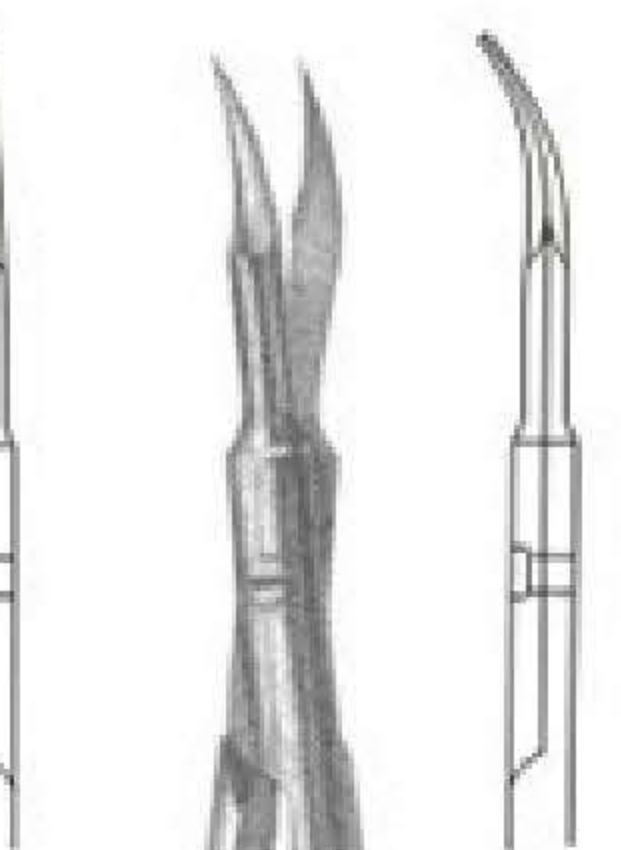
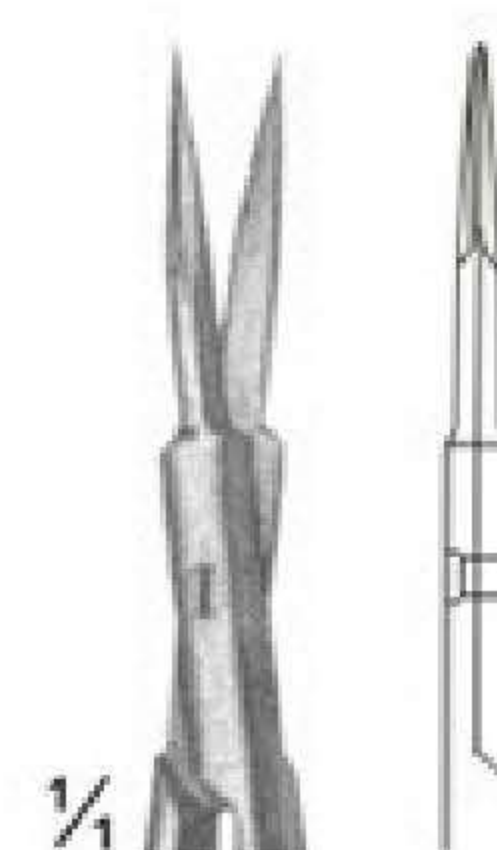

02-3019
 CASPAR
 Micro Scissor Curved

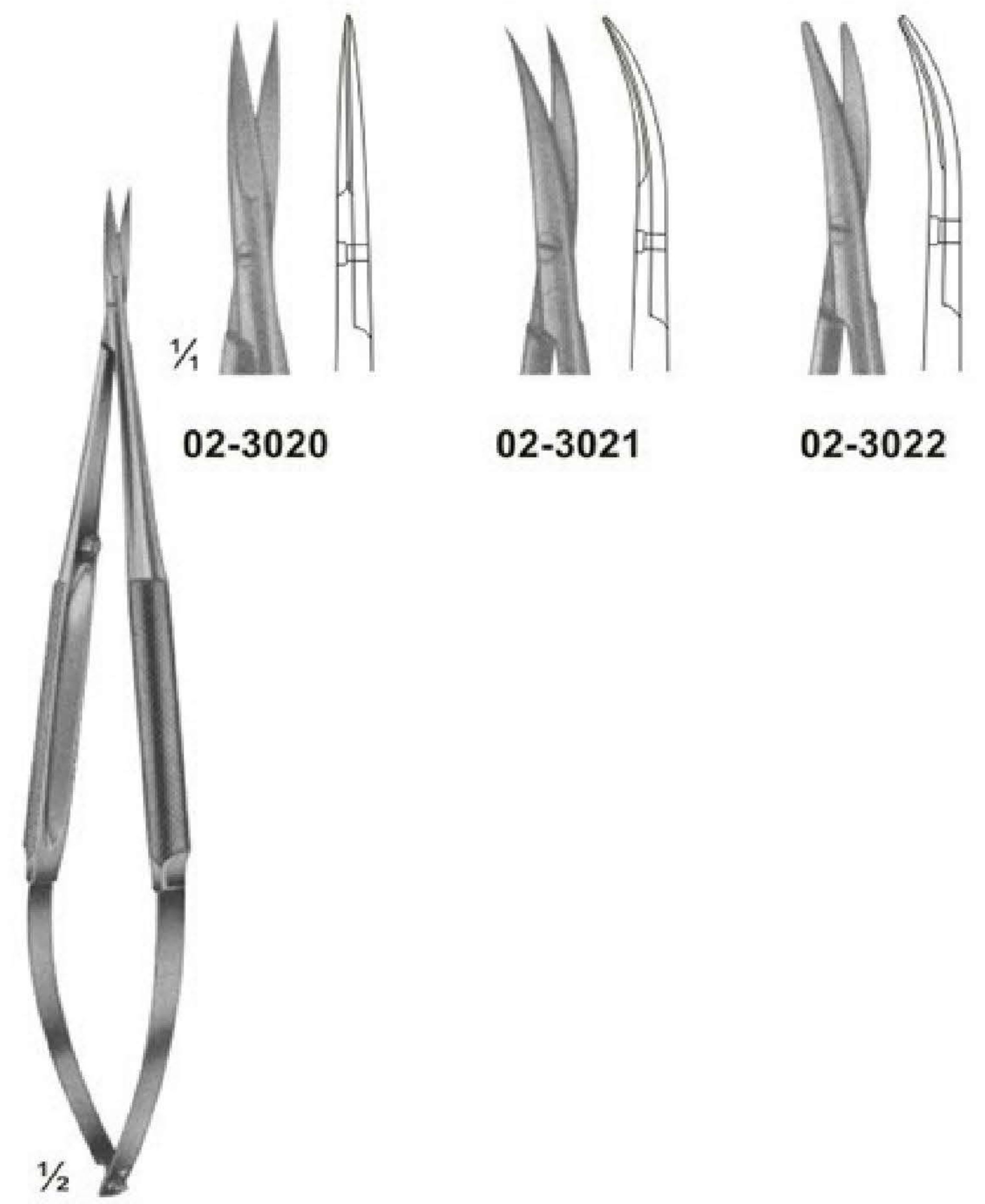
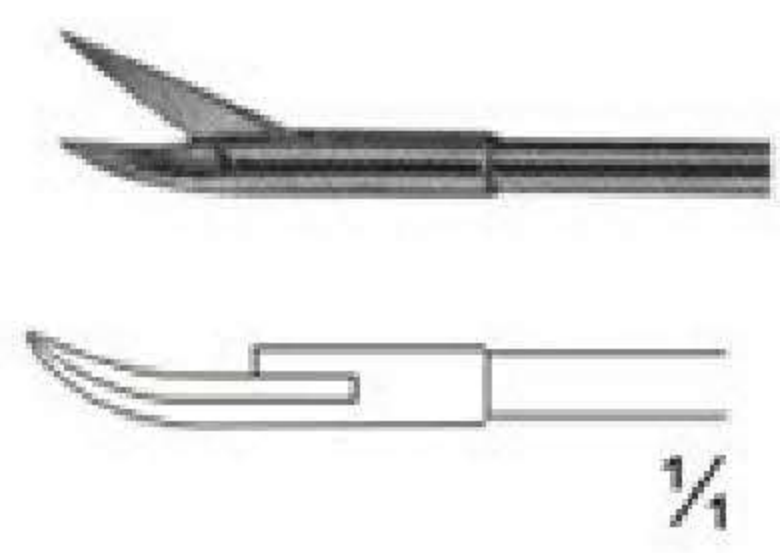

02-3020

02-3021

02-3022

02-3020 - 02-3022
 Micro Dissecting Scissor
 Size: 145 mm

Micro Scissors, "Spring Type" Bayonet Shape

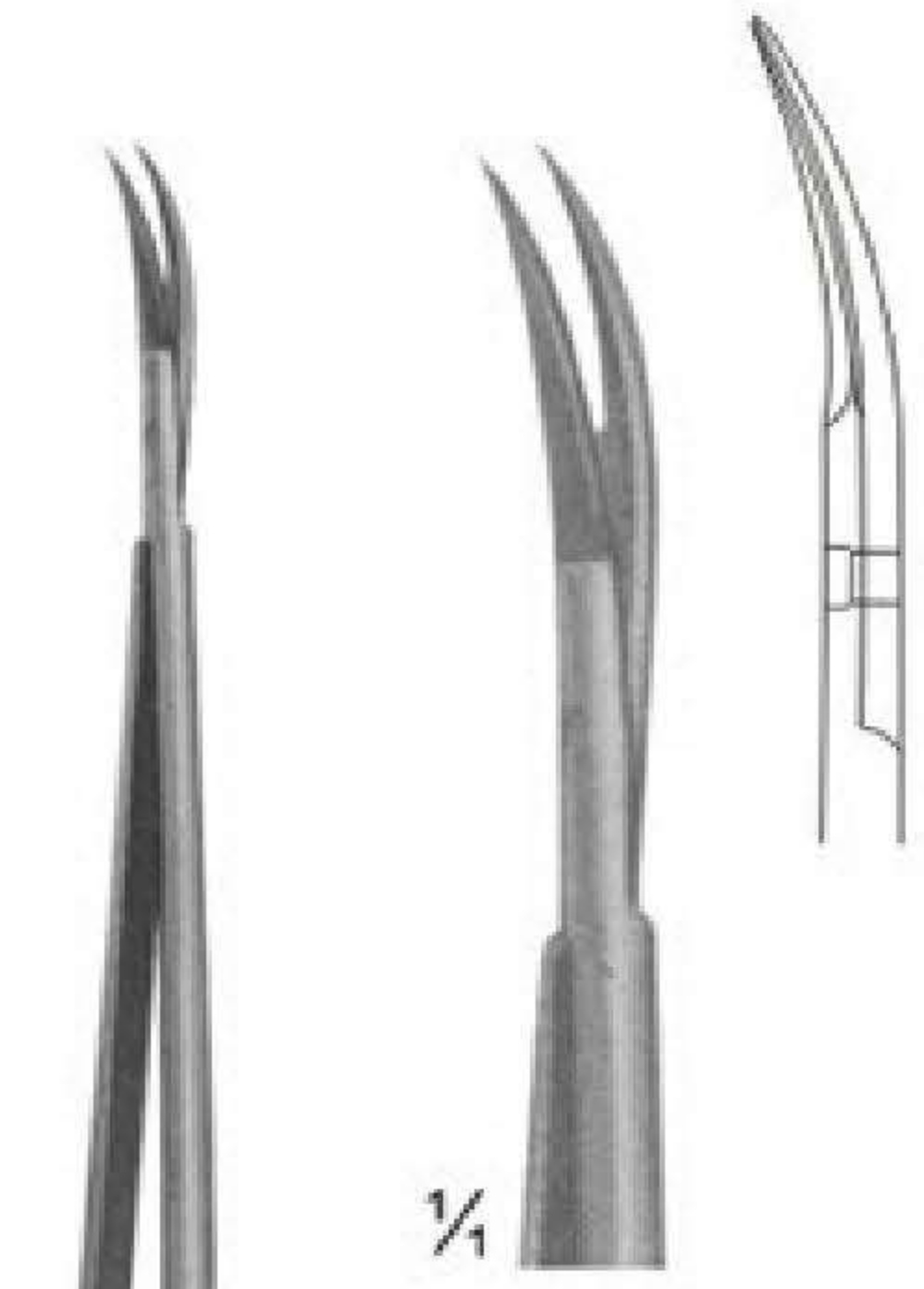

1/2
02-3023
 YASARGIL
 Size: 245 mm

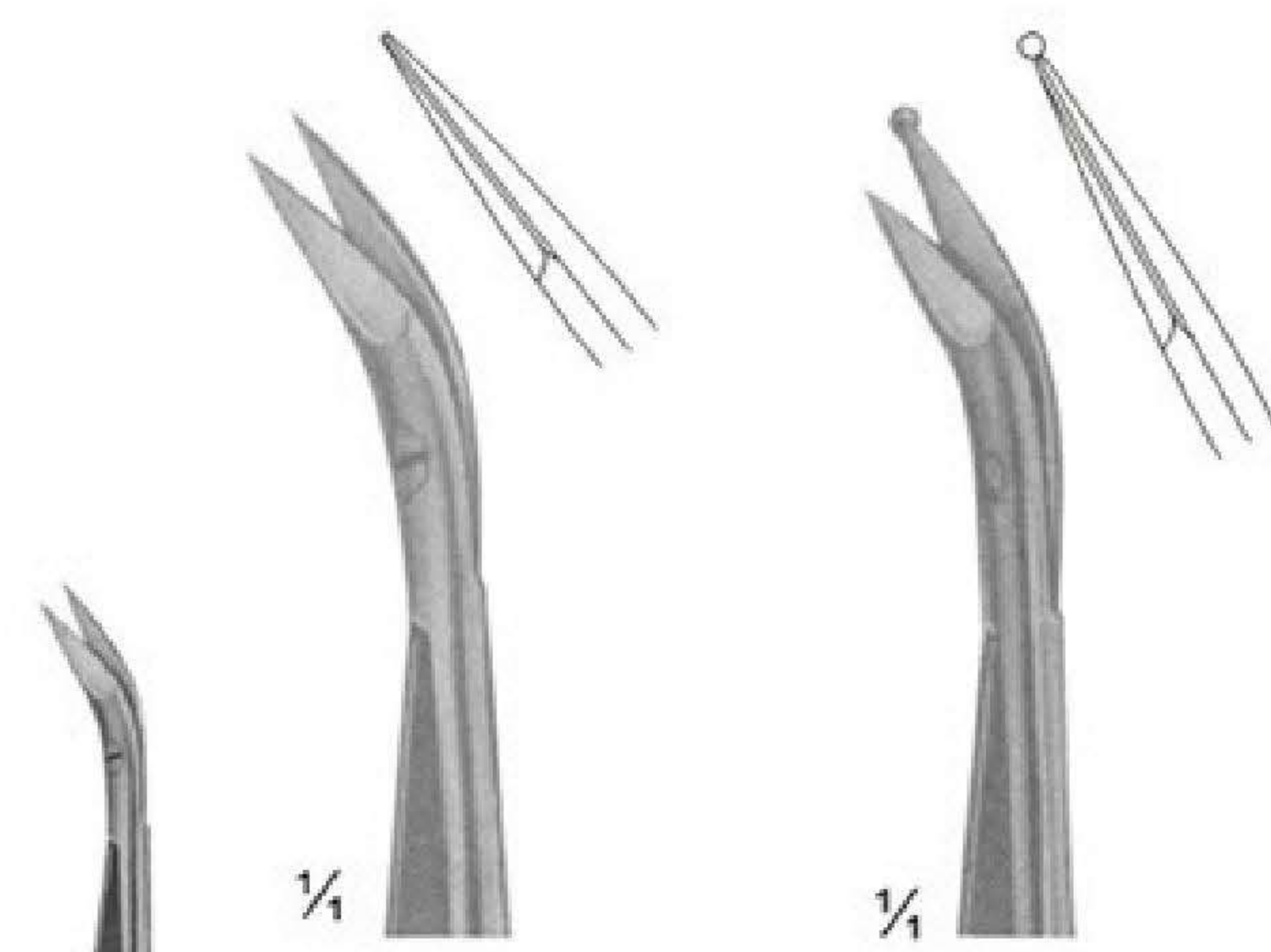

1/4
02-3024
 45°
 Nagel

1/4
02-3025
 45°



1/2
02-3024 - 02-3025
 Laterally Angled
 Size: 200 mm

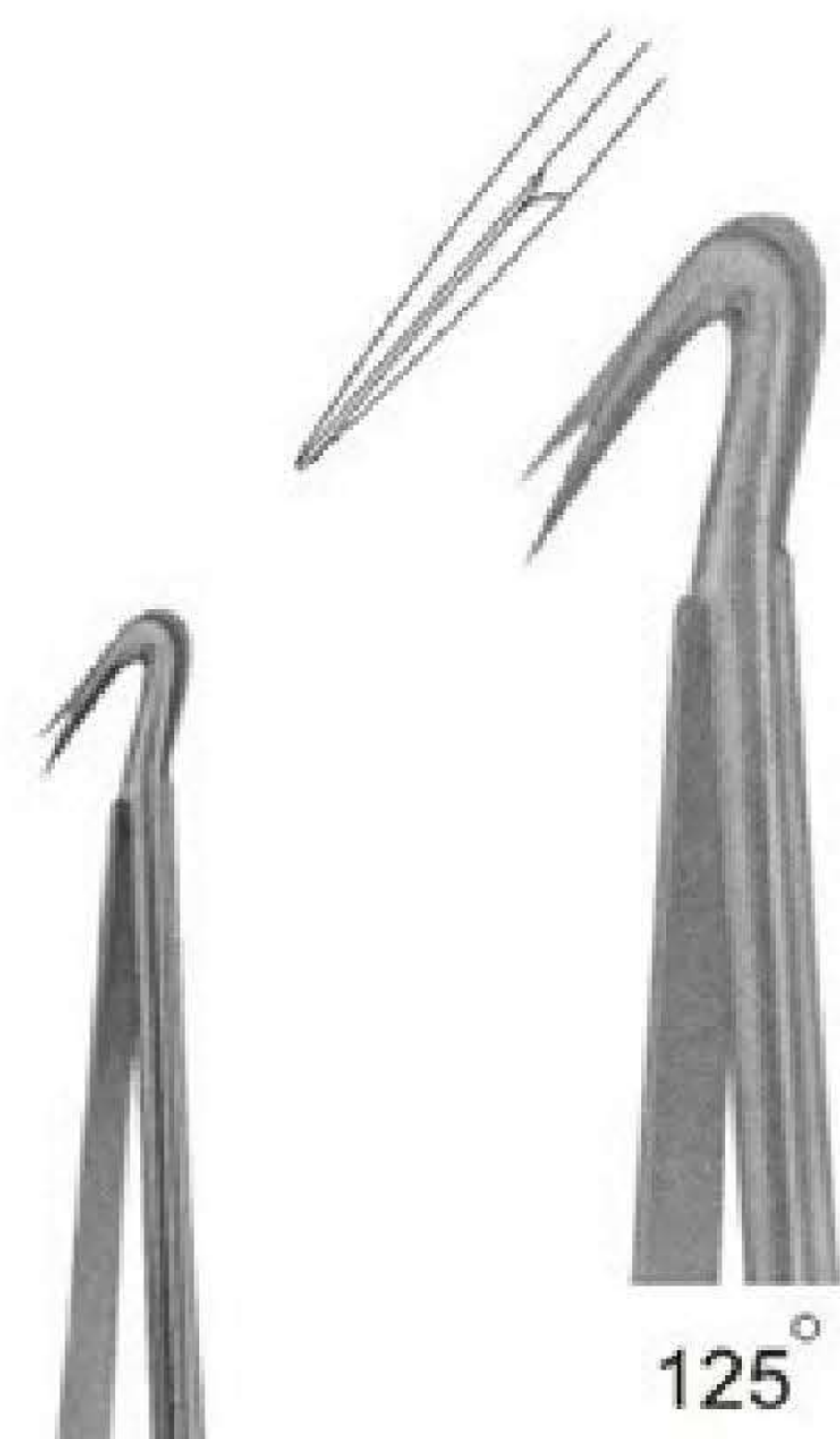

125°



1/2
02-3026
 Laterally Angled
 Size: 190 mm

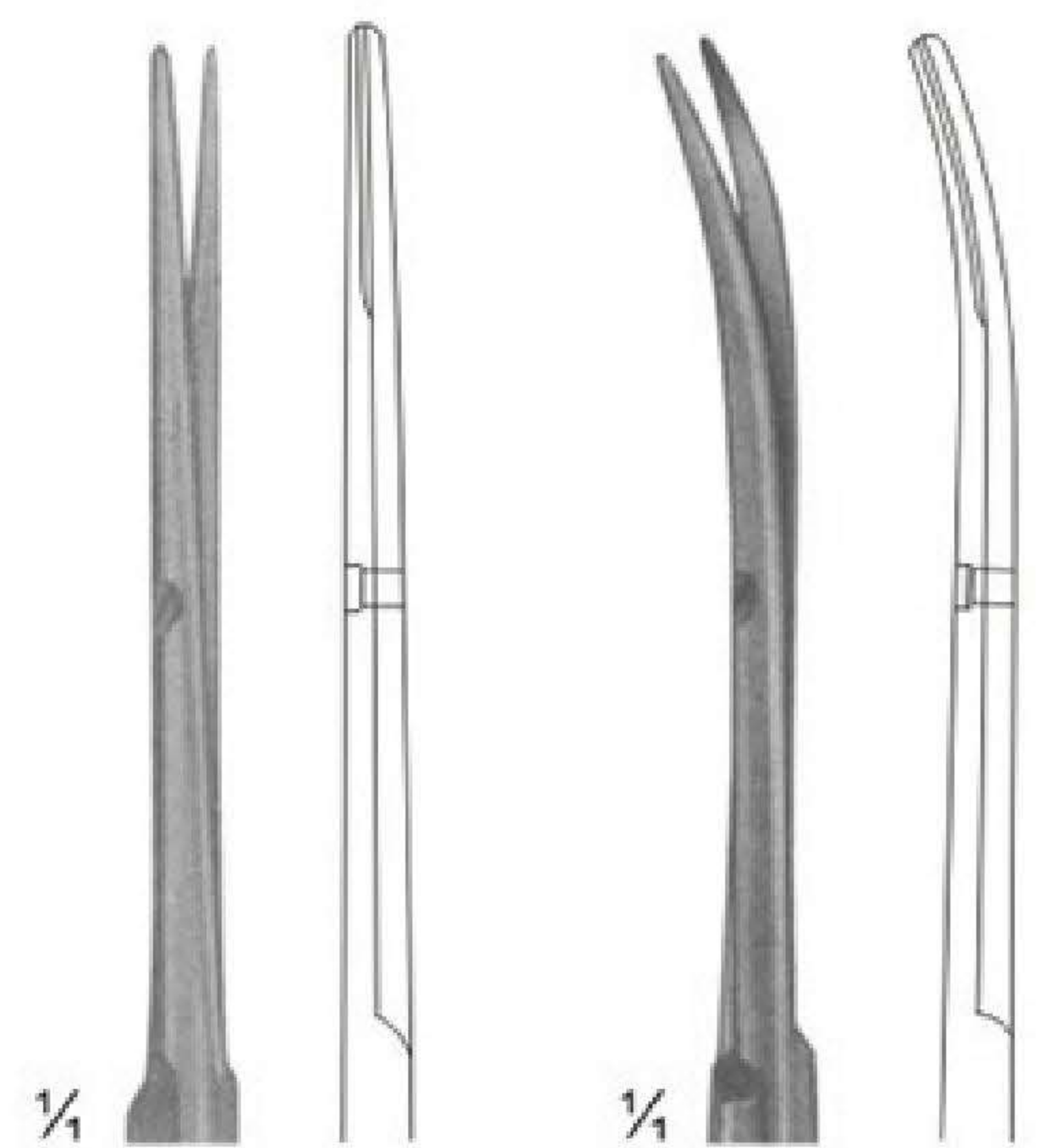

1/4
02-3027

1/4
02-3028



1/2
02-3027 - 02-3028
 YASARGIL
 Size: 225 mm

Delicate Scissors

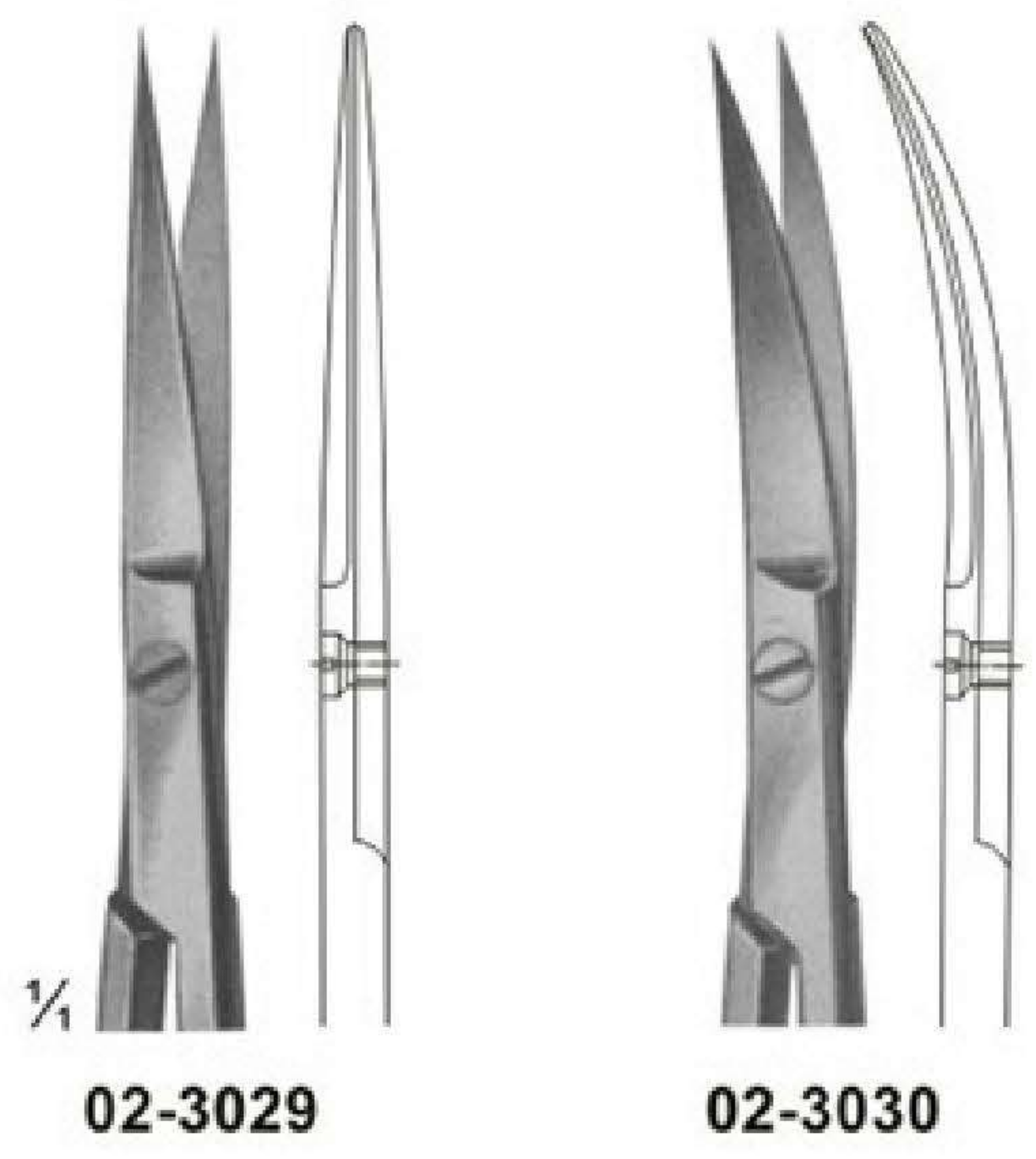
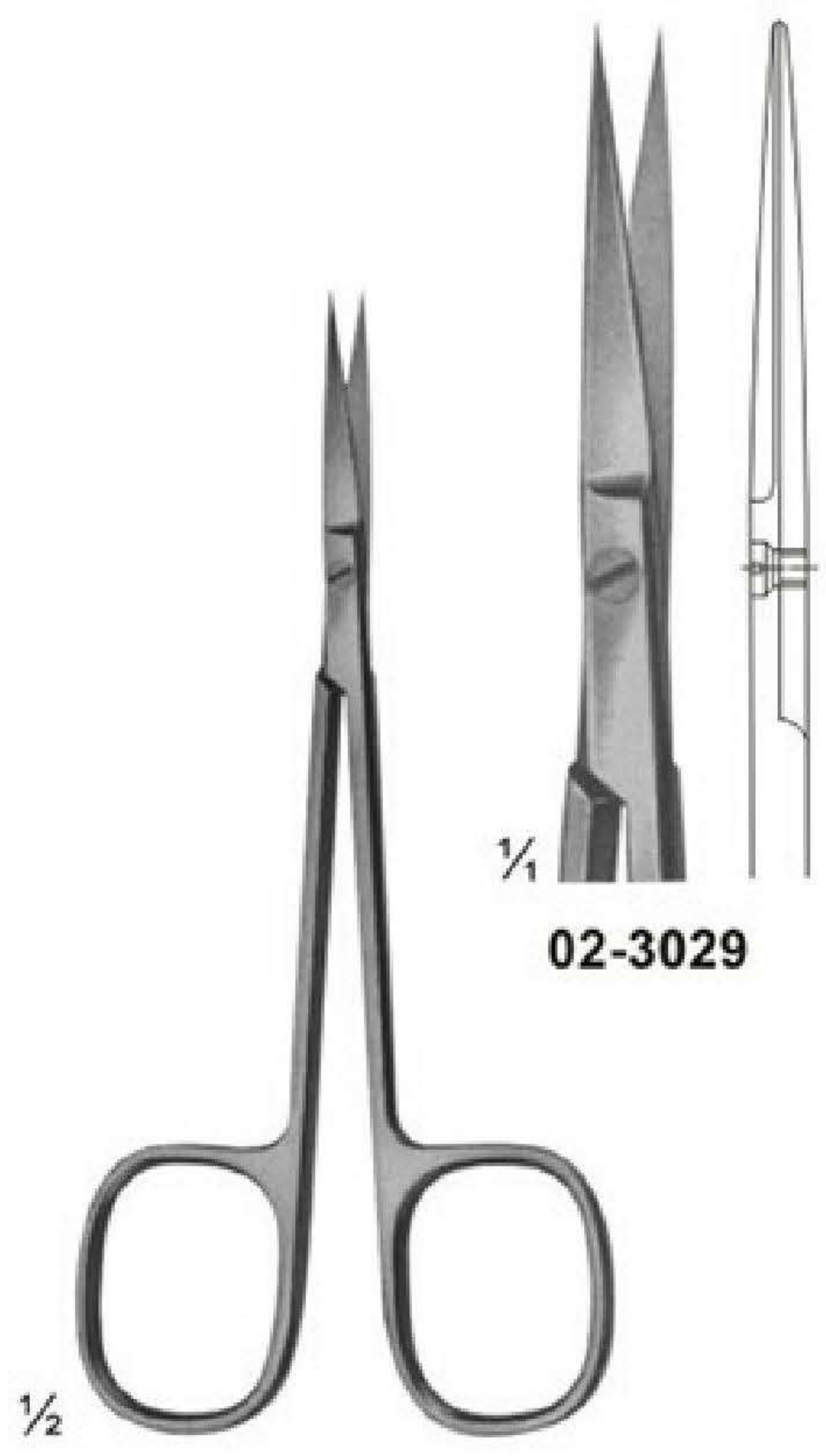

02-3029-02-3030
 Size: 120 mm

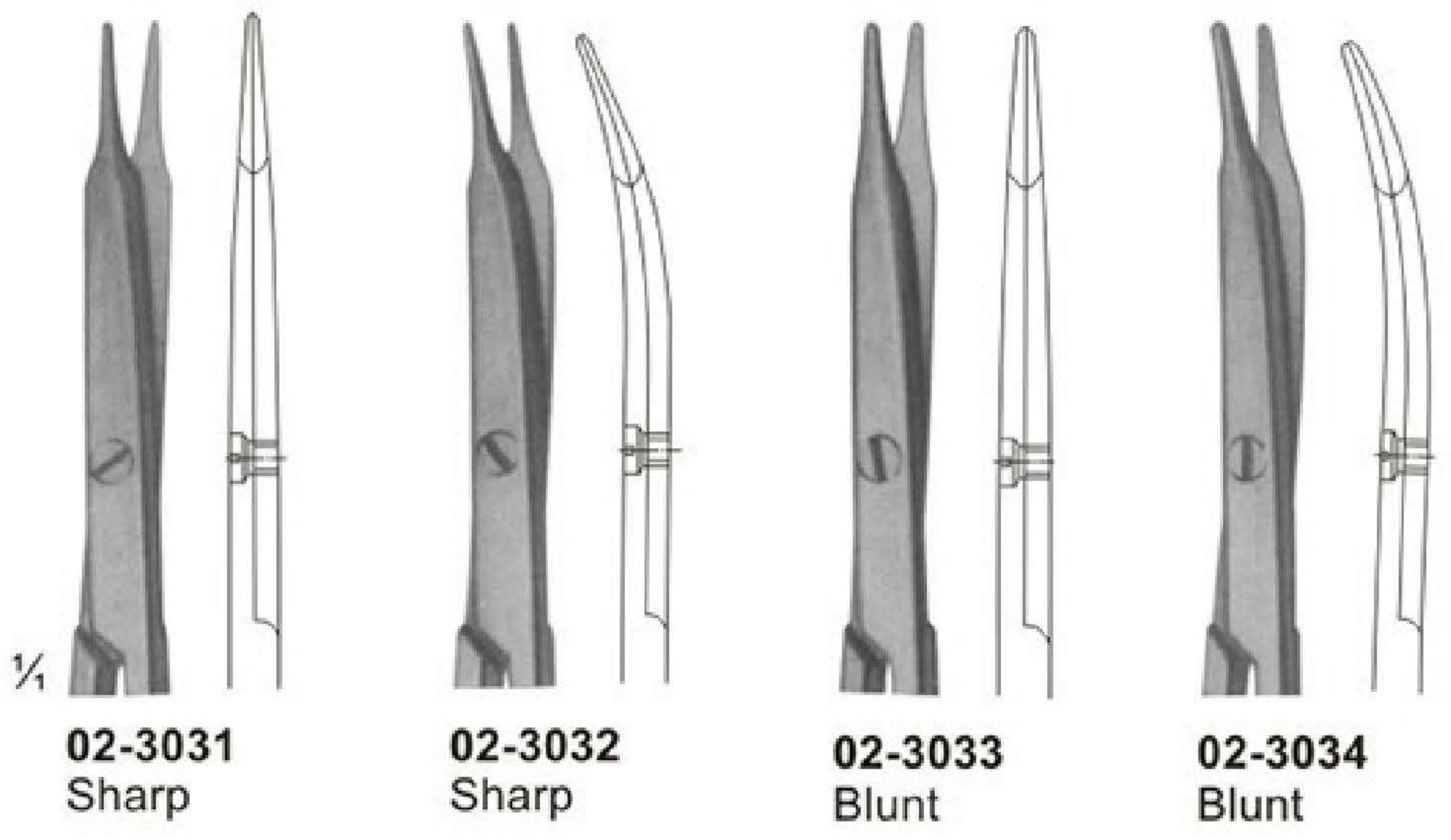
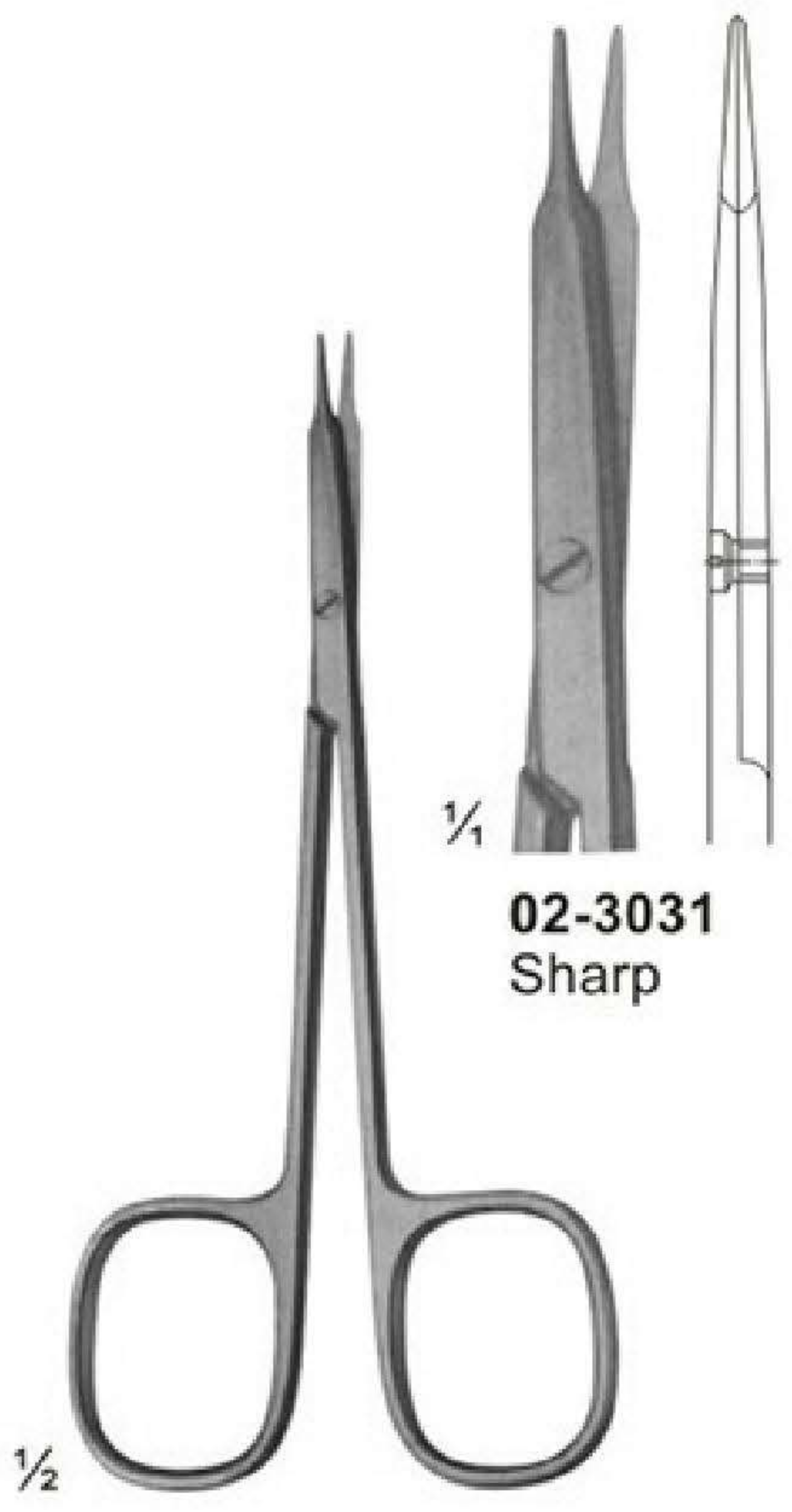

02-3031 - 02-3034
STEVENS
 Dissecting Scissors
 Size: 115 mm

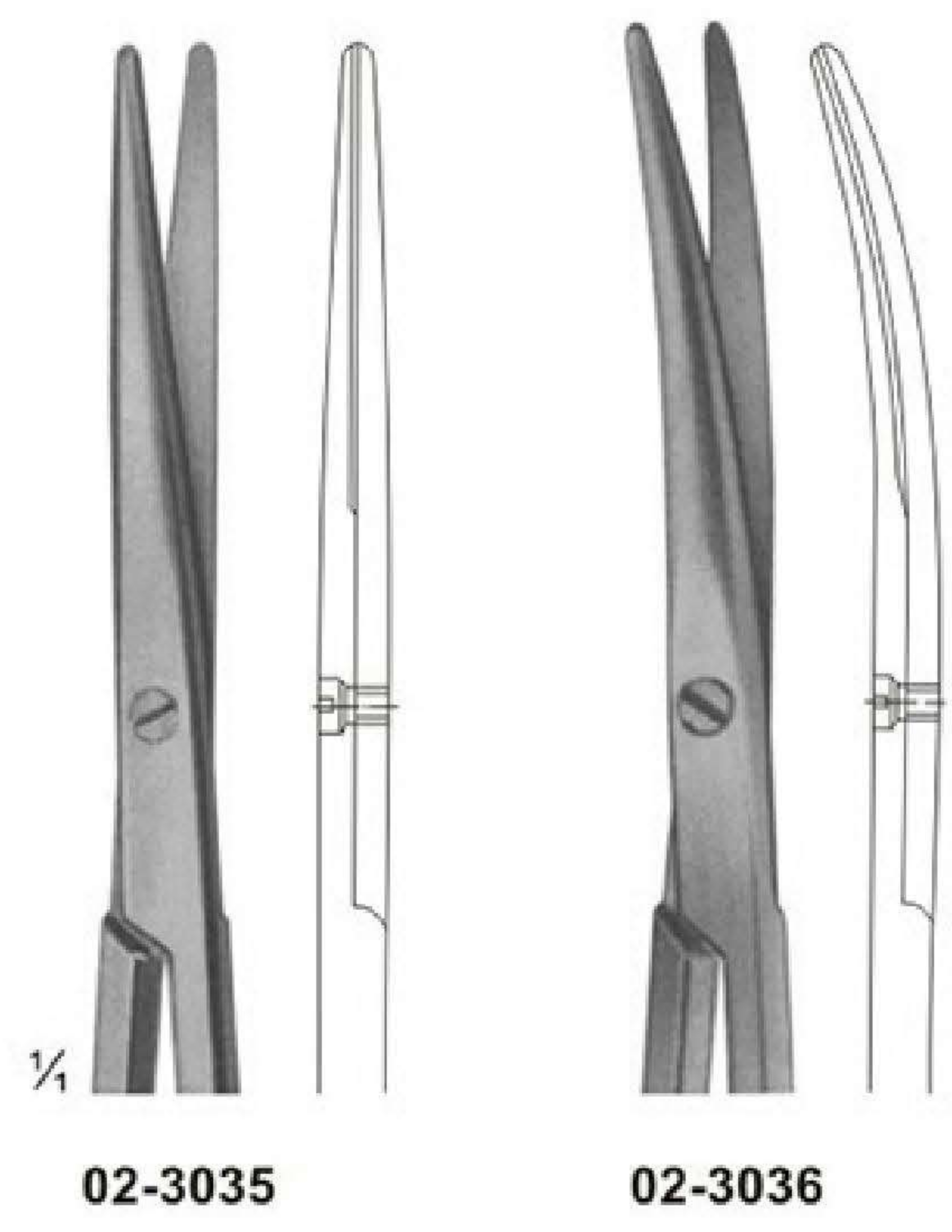
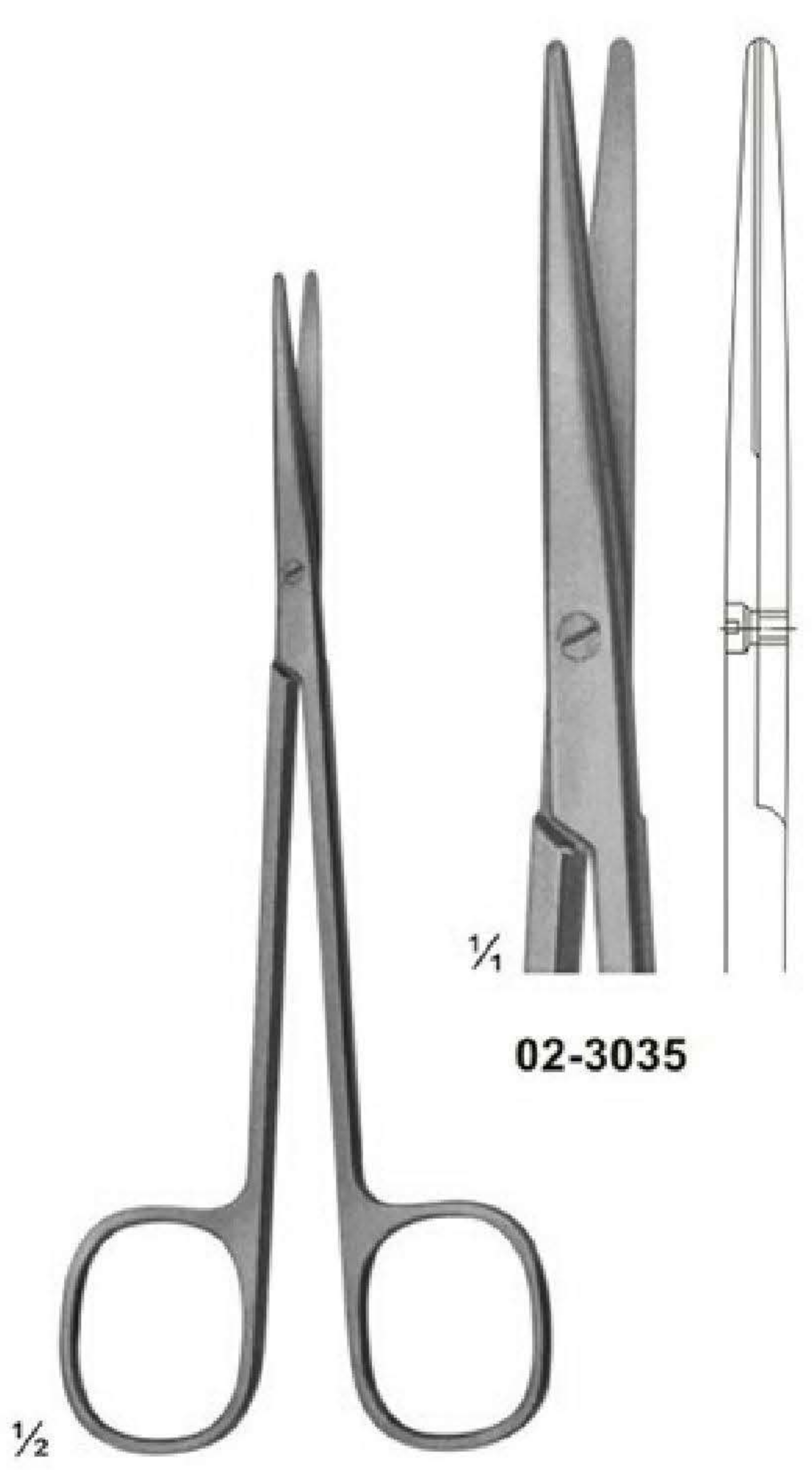

02-3035 - 02-3036
METZENBAUM
 Dissecting Scissors
 Size: 145 mm

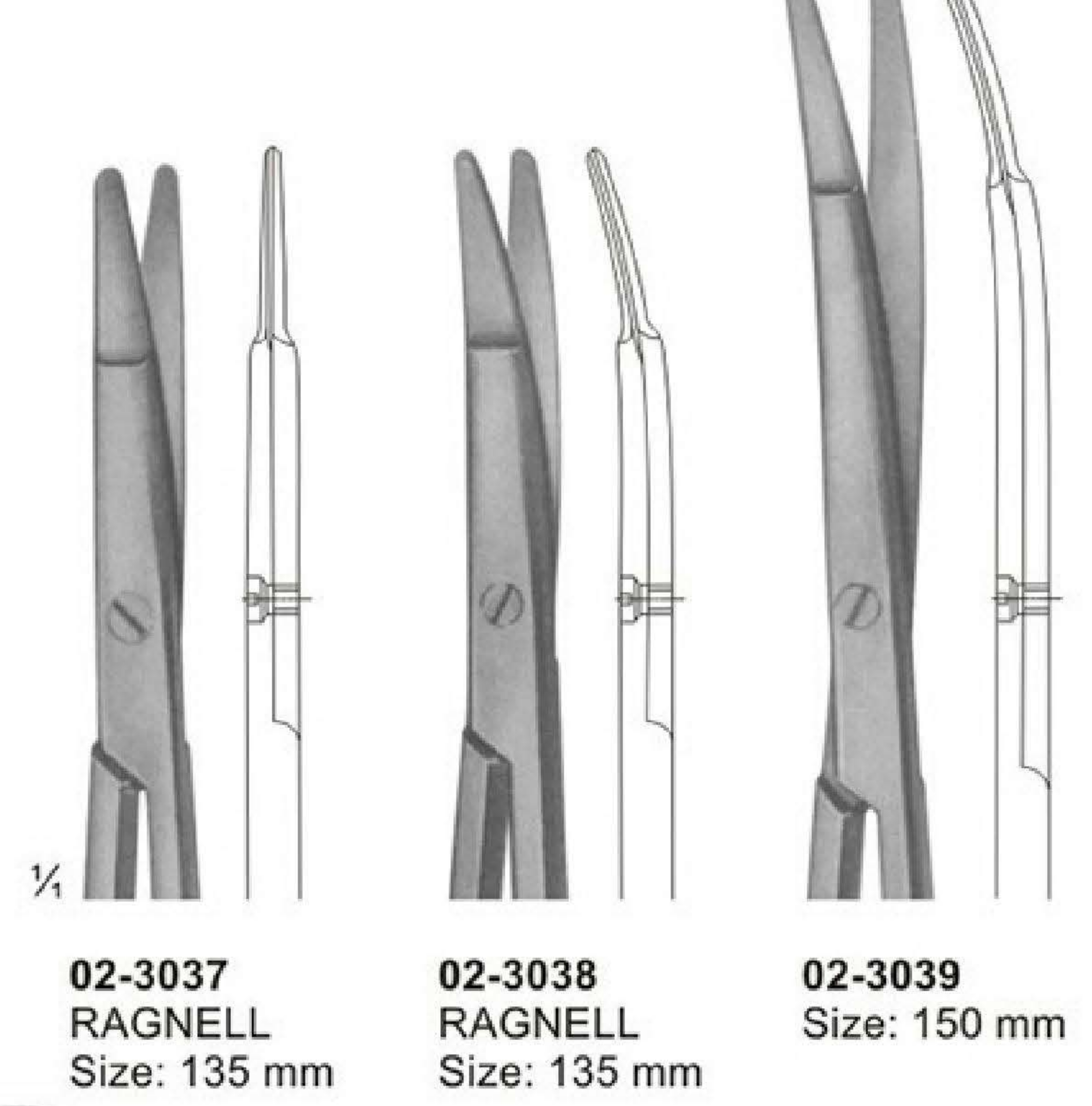
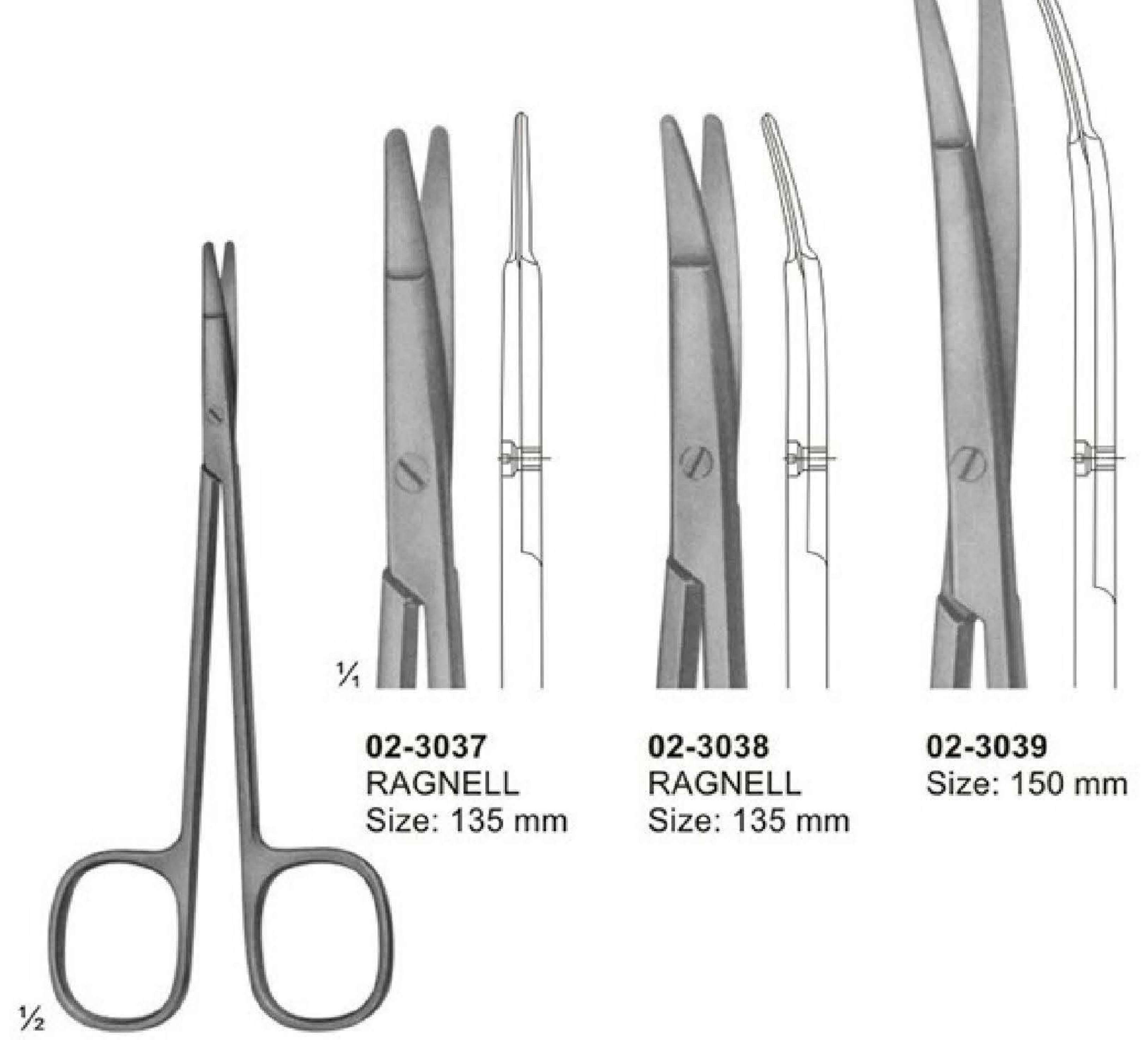

02-3037 - 02-3039
RAGNELL
 Special flat points for
 dissecting and
 undermining the skin

Delicate Scissors



Delicate Scissors



02-3050 - 02-3052
 Size: 120 mm

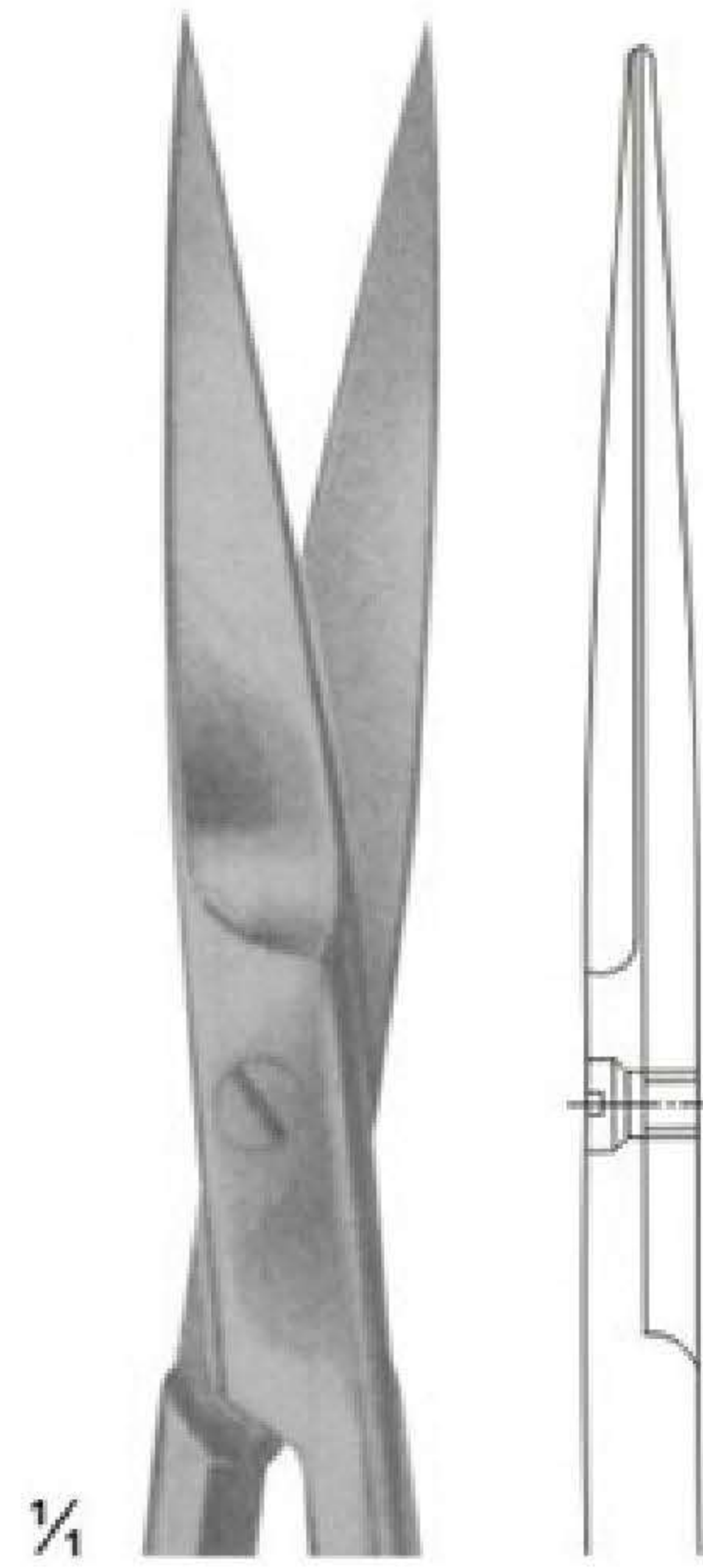

02-3050

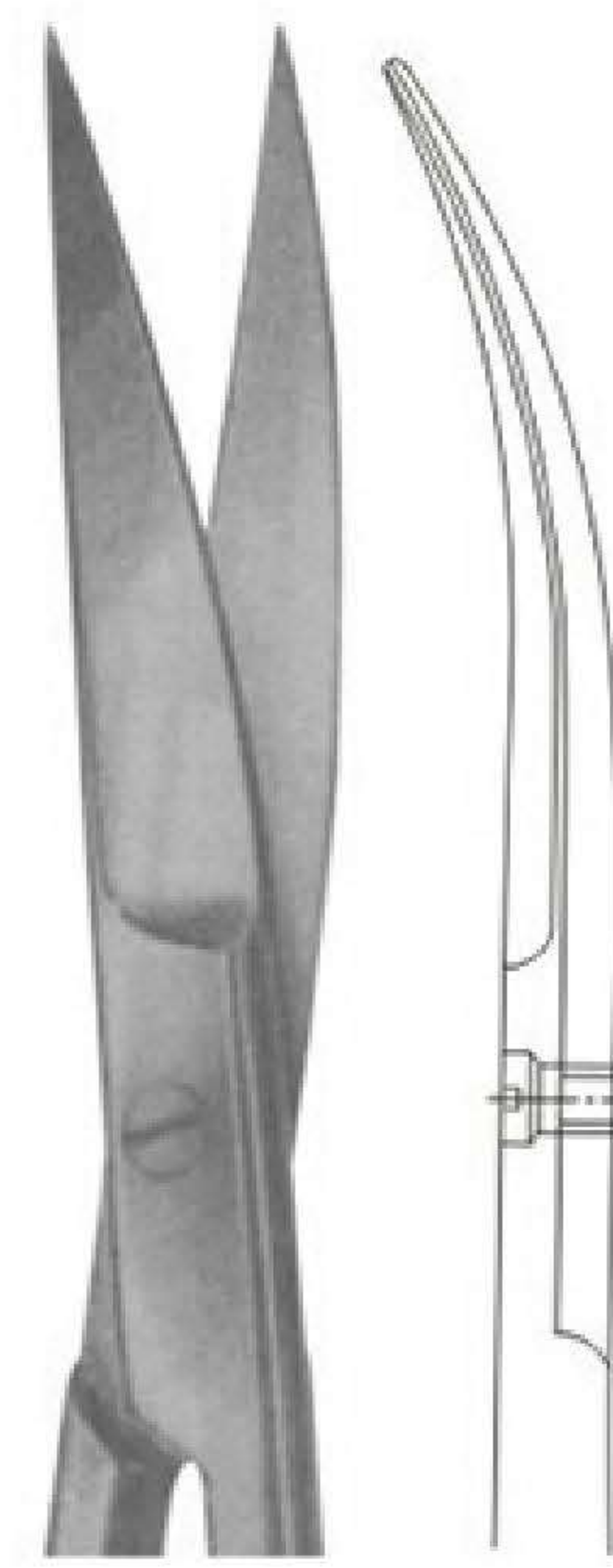

02-3051

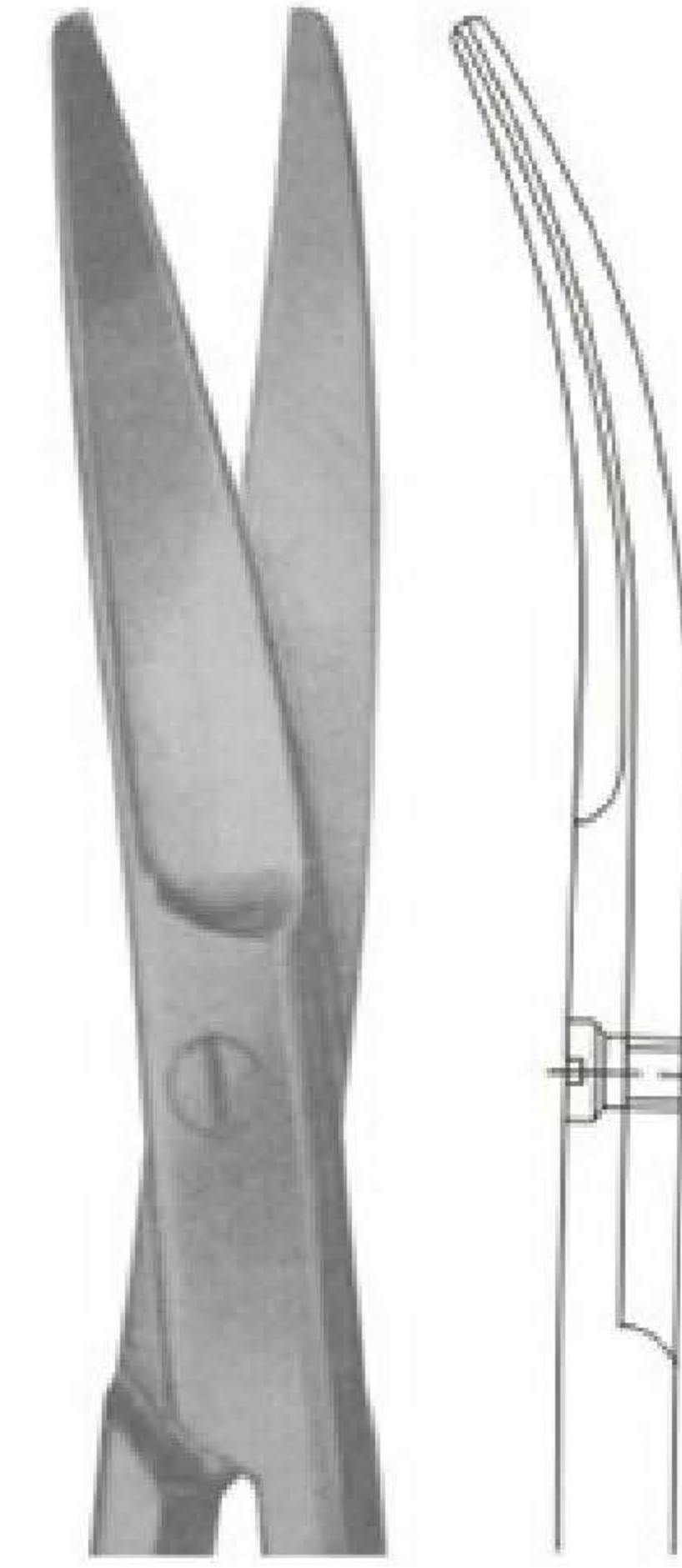

02-3052



02-3053 - 02-3056
 Size: 130 mm

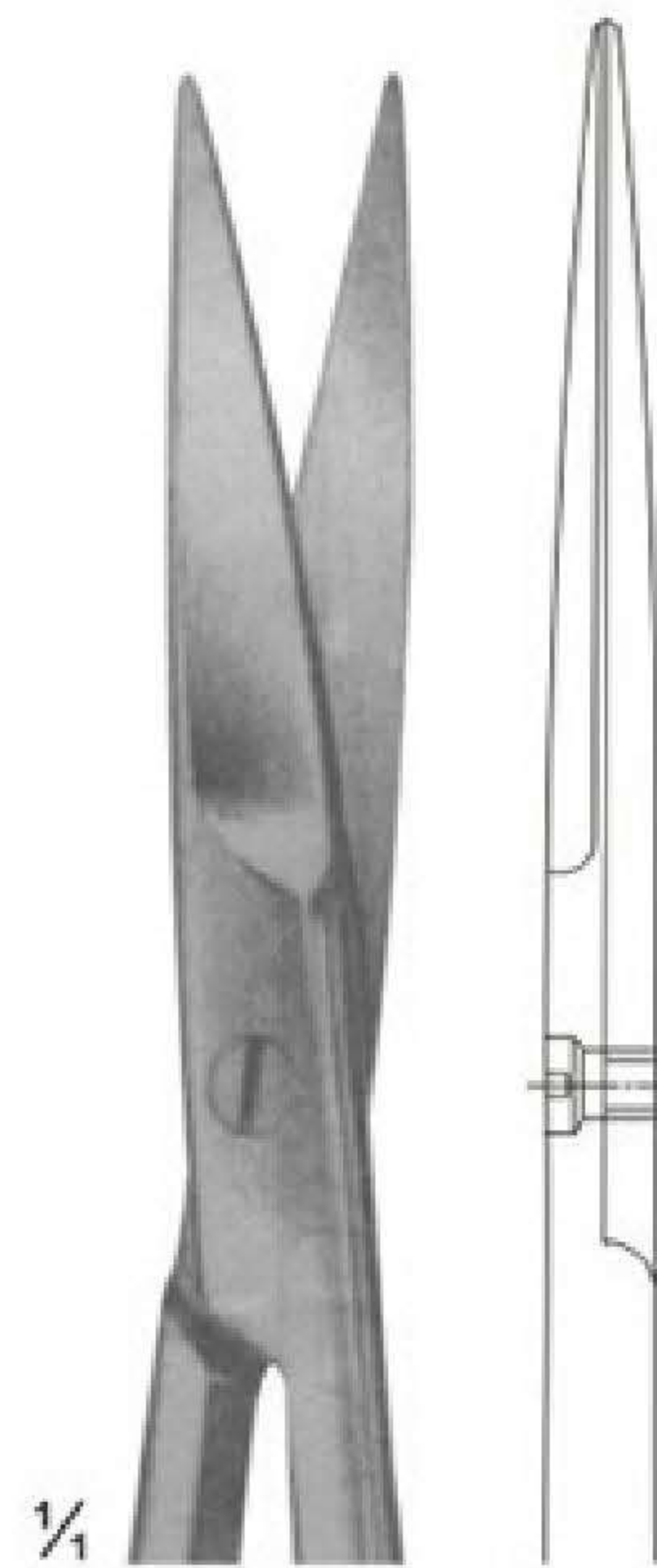

02-3053

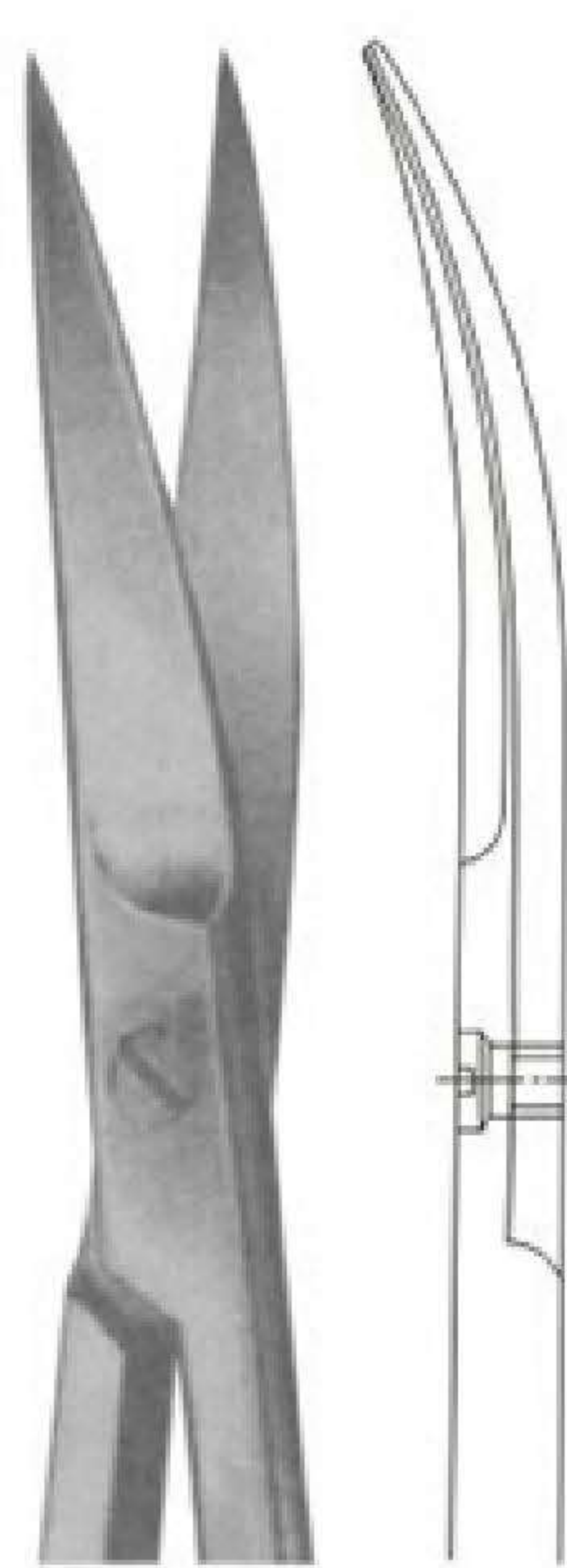

02-3054

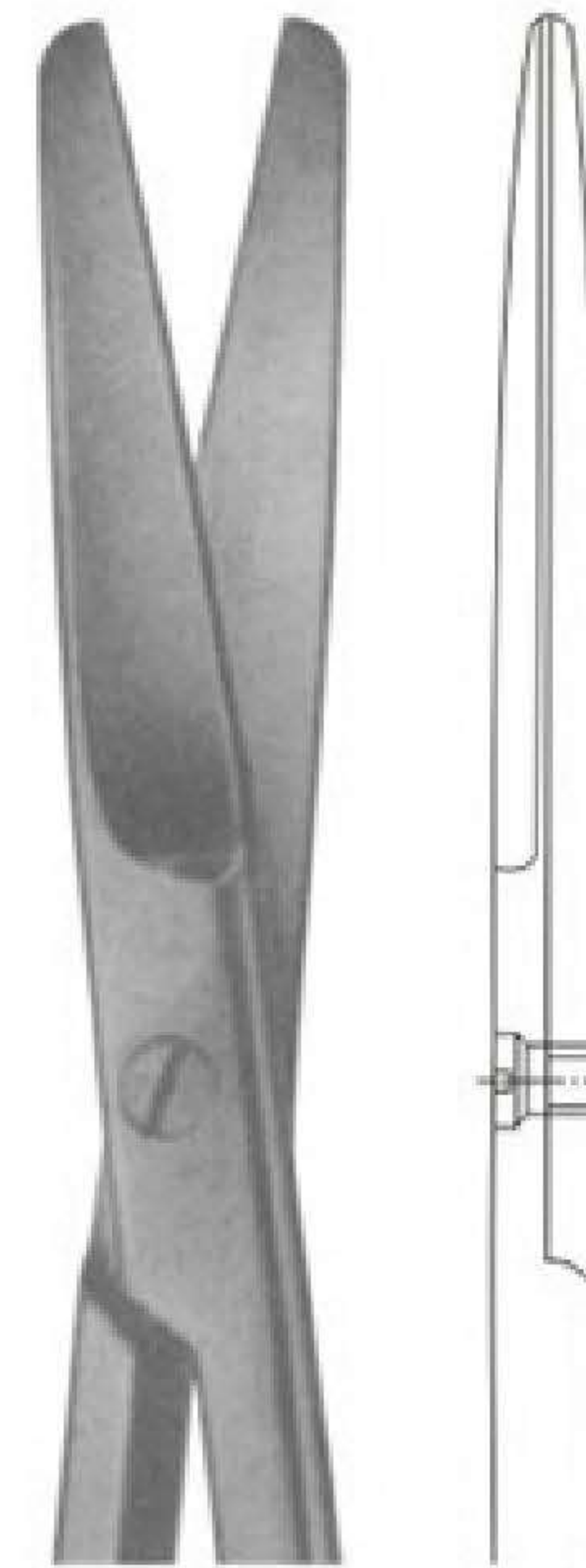

02-3055

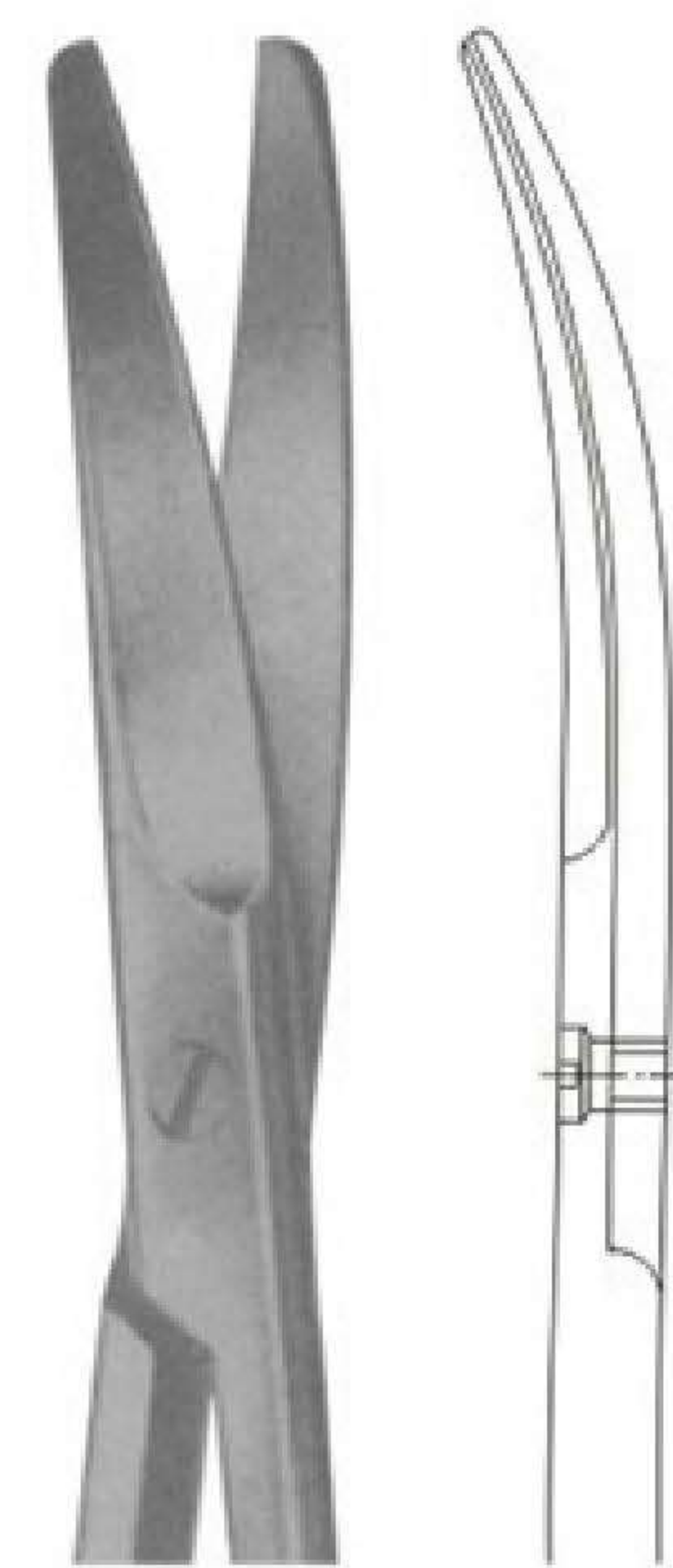

02-3056

Delicate Scissors

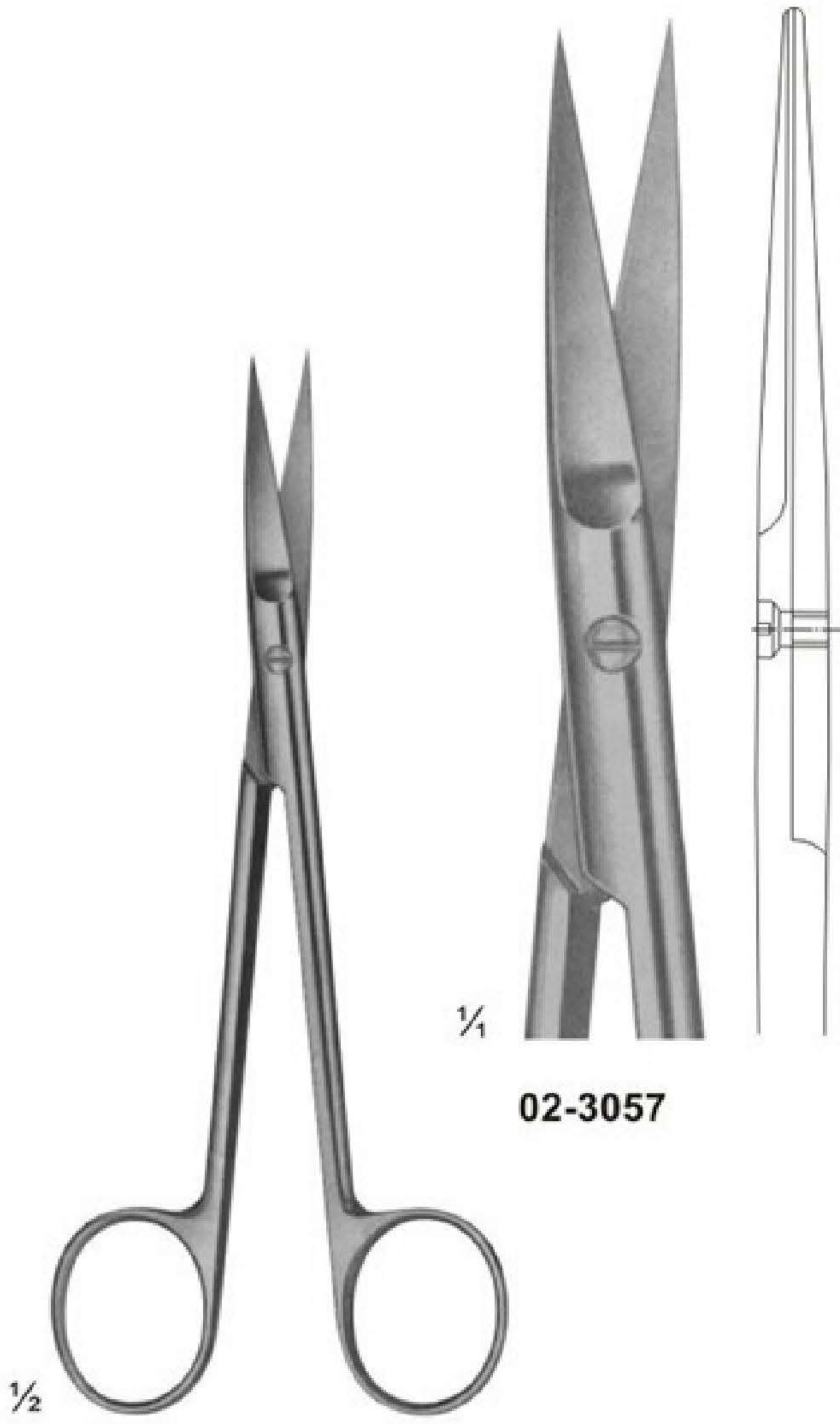

02-3057

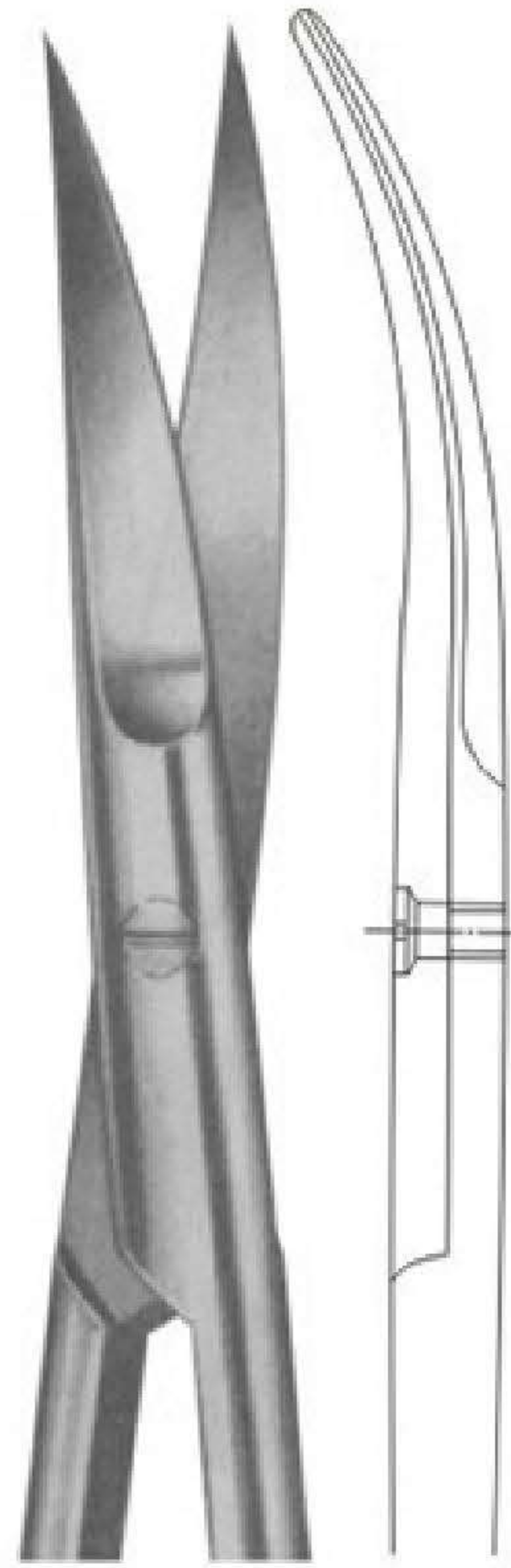

02-3058

02-3057 - 02-3058
 JOSEPH
 Size: 150 mm

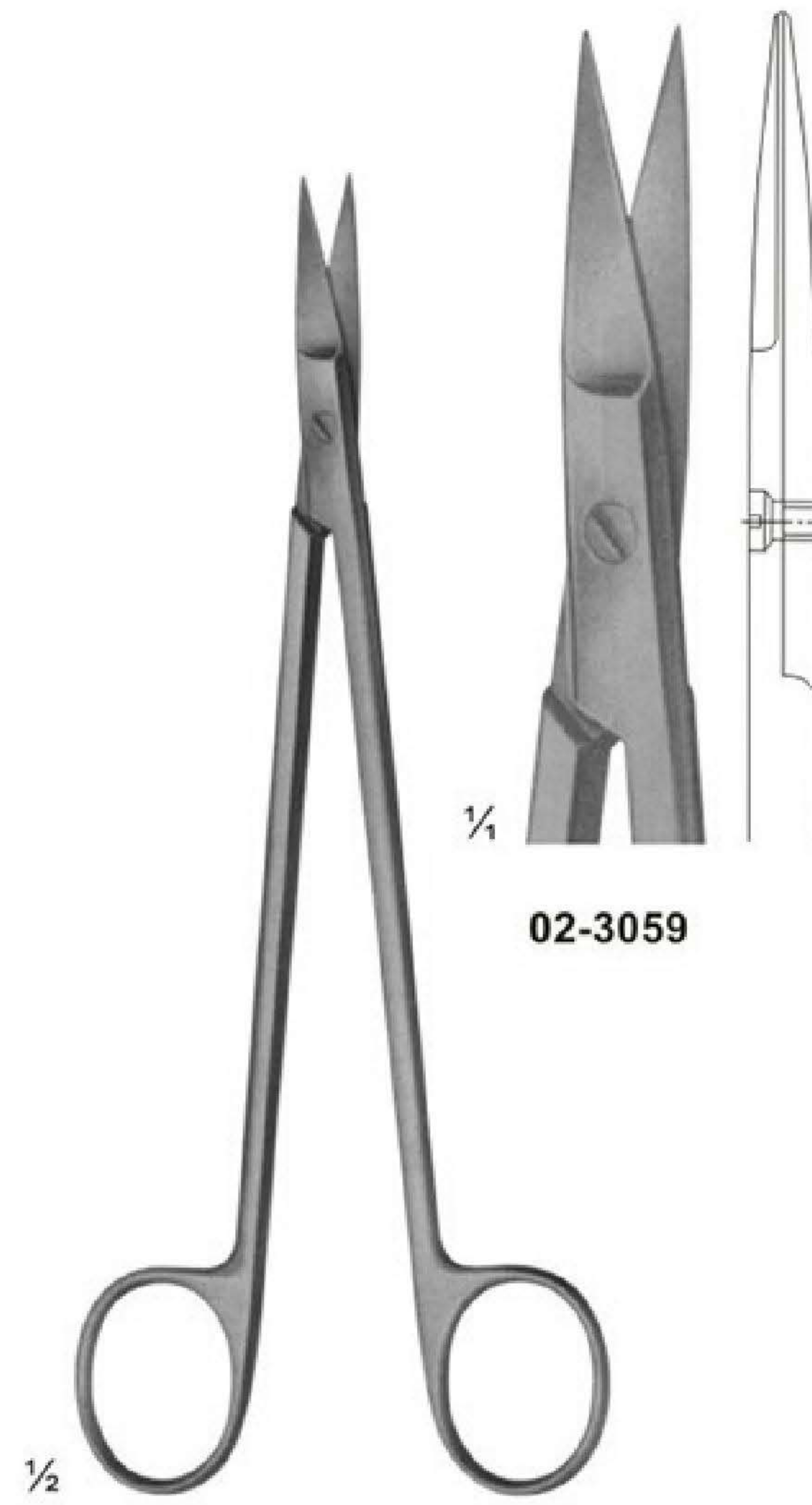

02-3059

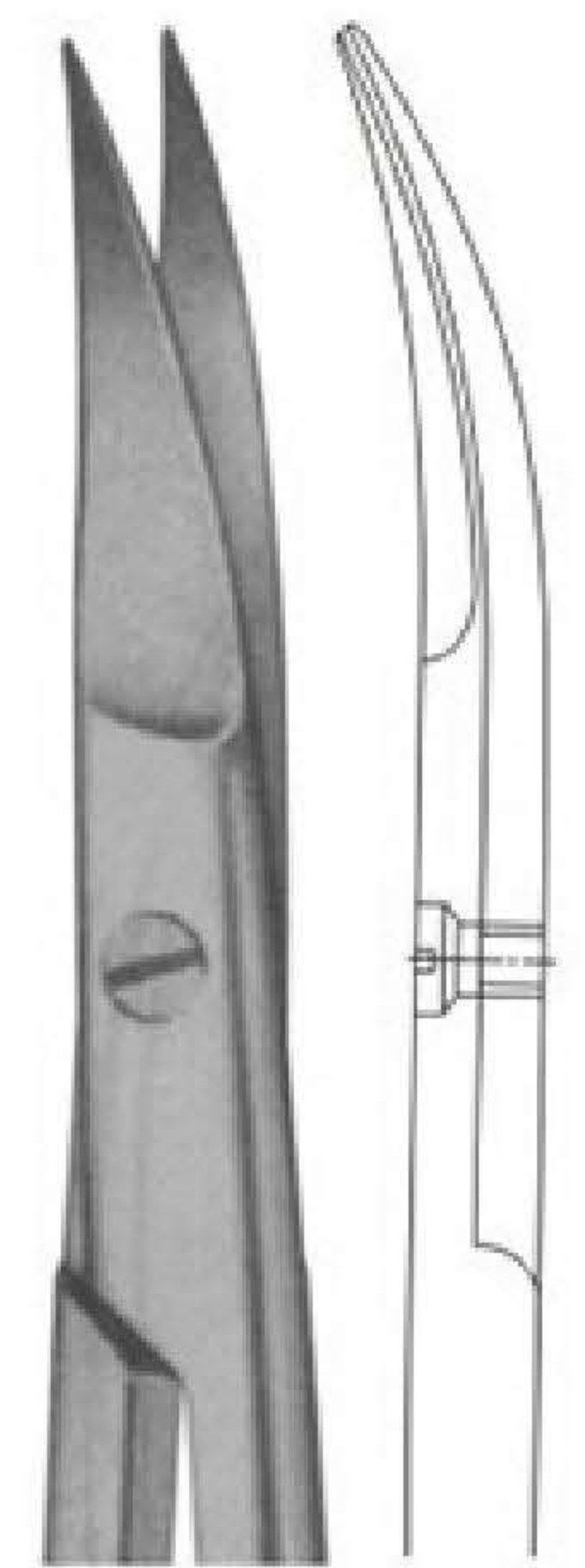

02-3060

02-3059 - 02-3060
 KELLY
 Size: 175 mm



02-3061
 QUINBY
 Size: 130 mm

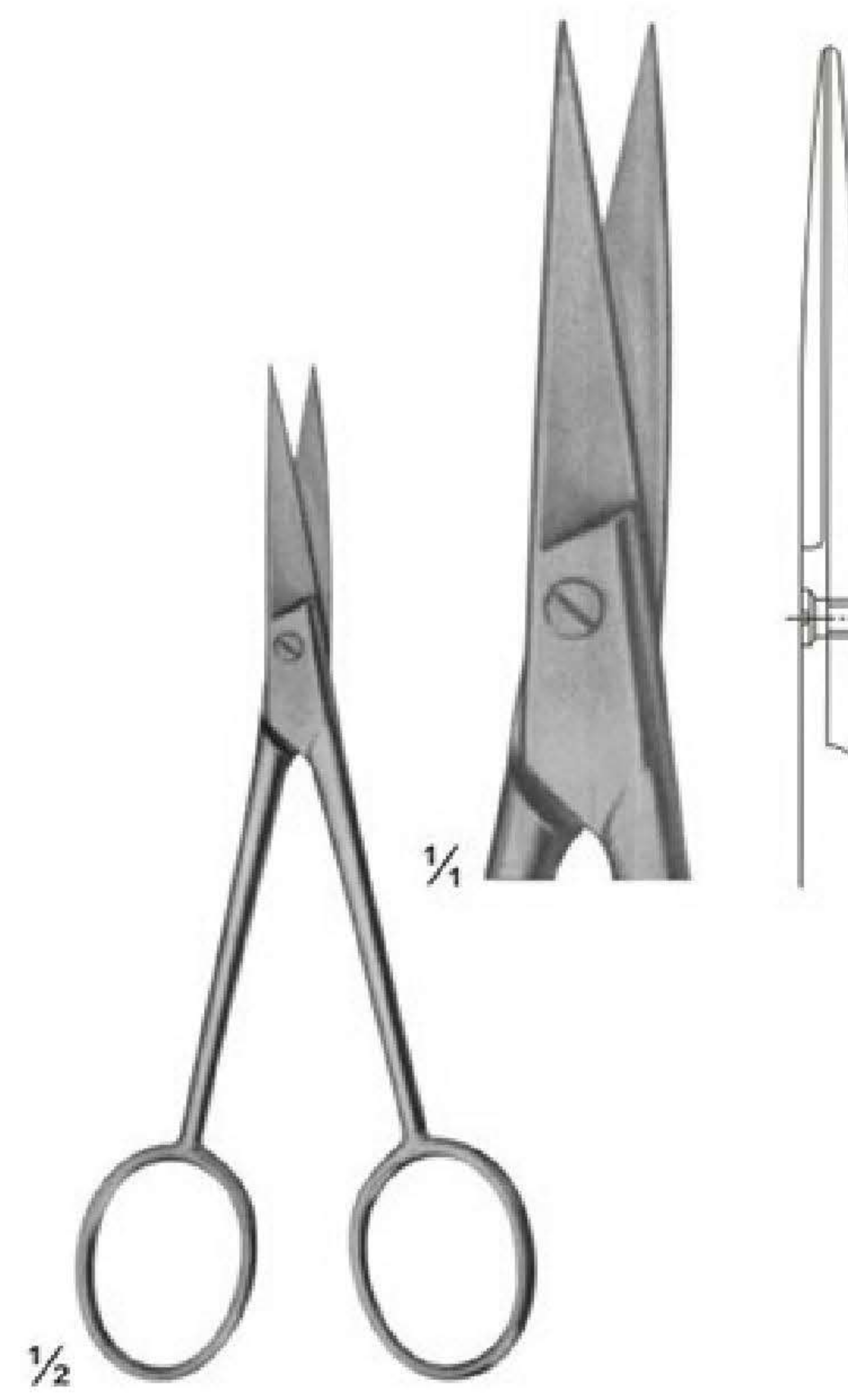

02-3062
 Size: 110 mm

Surgical Scissors



02-3063 - 02-3071 (Standard Types)
02-3063 (105 mm)
02-3064 (115 mm)
02-3065 (130 mm)
02-3066 (145 mm)
02-3067 (150 mm)
02-3068 (165 mm)
02-3069 (175 mm)
02-3070 (185 mm)
02-3071 (200 mm)

02-3063
Size: 105 mm

02-3071
Size: 200 mm

02-3072 - 02-3078 (Standard Types)
02-3072 (115 mm)
02-3073 (130 mm)
02-3074 (145 mm)
02-3075 (150 mm)
02-3076 (165 mm)
02-3077 (175 mm)
02-3078 (185 mm)

02-3072
Size: 115 mm

02-3078
Size: 185 mm

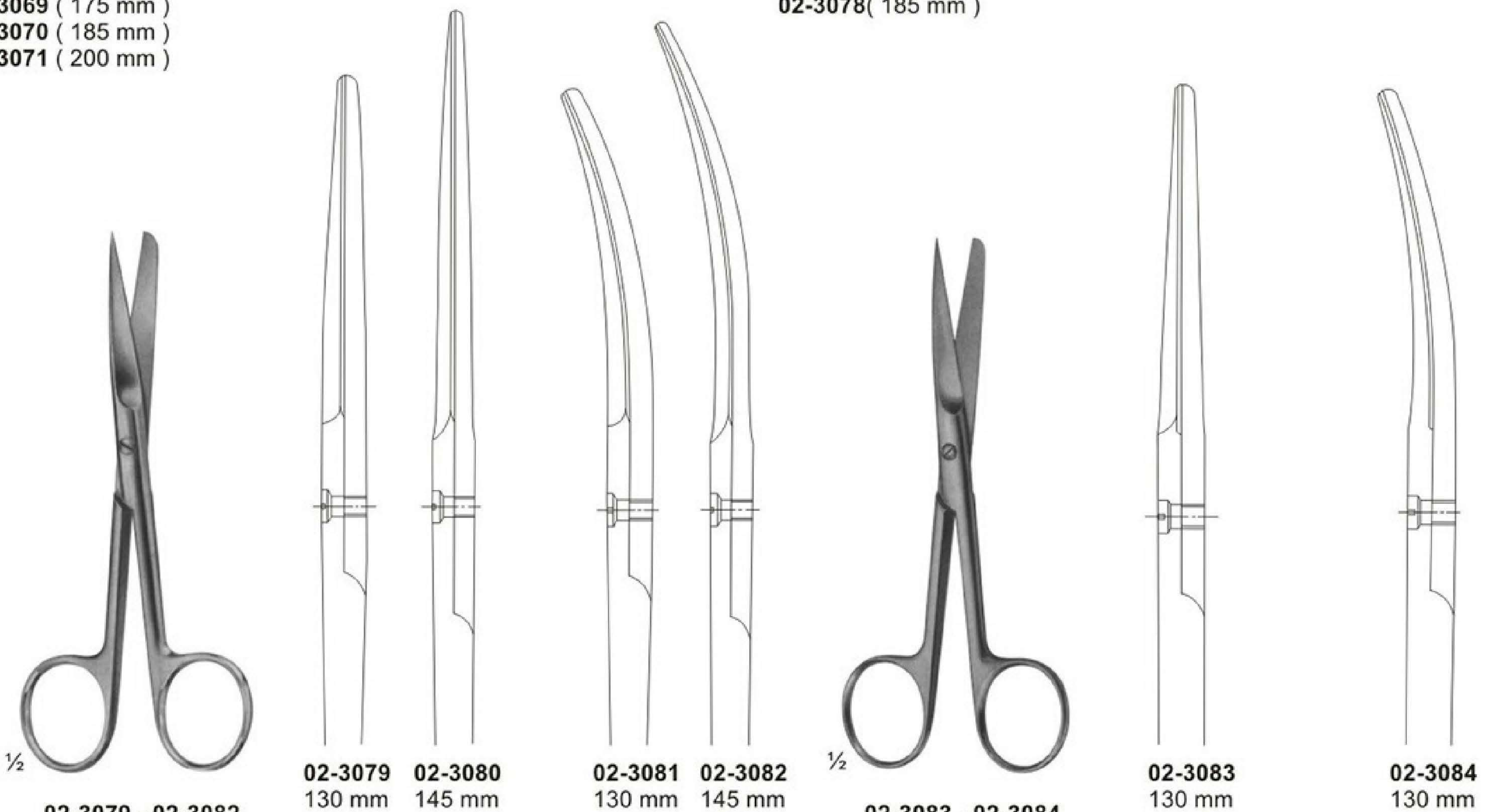

02-3079 - 02-3082
Slender Types

02-3079 130 mm
02-3080 145 mm

02-3081 130 mm
02-3082 145 mm

02-3083 - 02-3084
For Wound Edges
1 Blade Serrated

02-3083
130 mm

02-3084
130 mm

Surgical Scissors



02-3085 - 02-3089 (Standard Types)
02-3085 (130 mm)
02-3086 (145 mm)
02-3087 (150 mm)
02-3088 (165 mm)
02-3089 (175 mm)

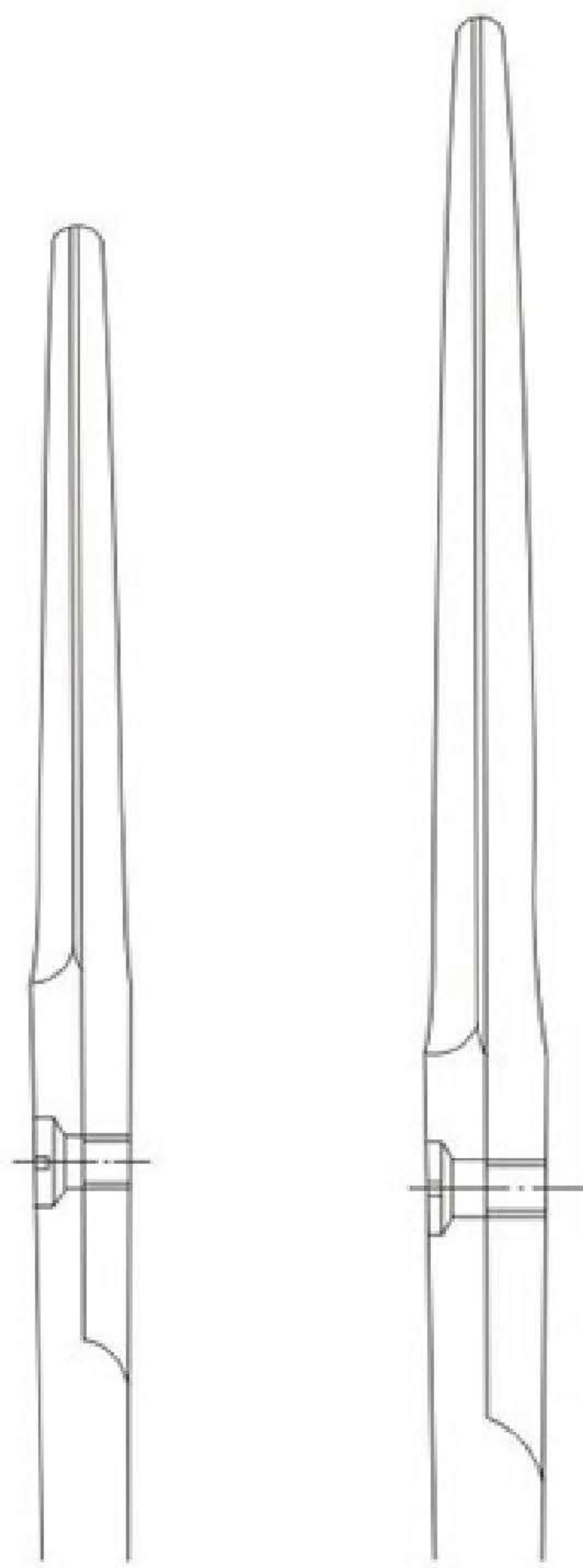

02-3085 Size: 130 mm **02-3089** Size: 175 mm



02-3090 - 02-3095 - COOPER
 Standard Types
02-3090 (115 mm)
02-3091 (130 mm)
02-3092 (145 mm)
02-3093 (150 mm)
02-3094 (165 mm)
02-3095 (175 mm)

02-3090 Size: 115 mm **02-3095** Size: 175 mm



02-3096 - 02-3102A
 Standard Types
02-3096 (115 mm) **02-3100A** (115 mm)
02-3097 (130 mm) **02-3101** (130 mm)
02-3098 (145 mm) **02-3101A** (145 mm)
02-3099 (150 mm) **02-3102** (150 mm)
02-3100 (165 mm) **02-3102A** (165 mm)

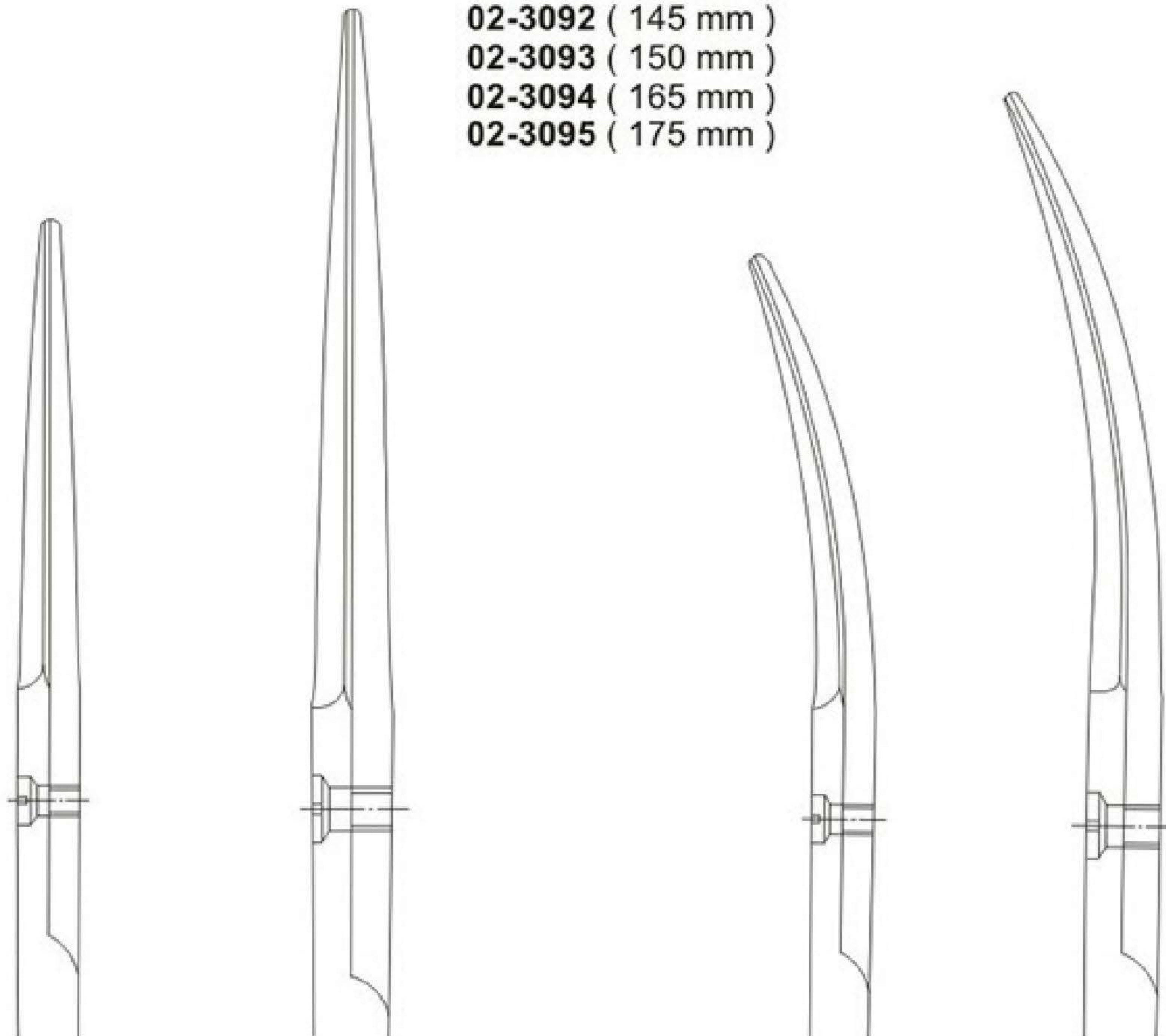

02-3096 Size: 115 mm **02-3100** Size: 165 mm

02-3100A Size: 115 mm **02-3102A** Size: 165 mm

Surgical Scissors

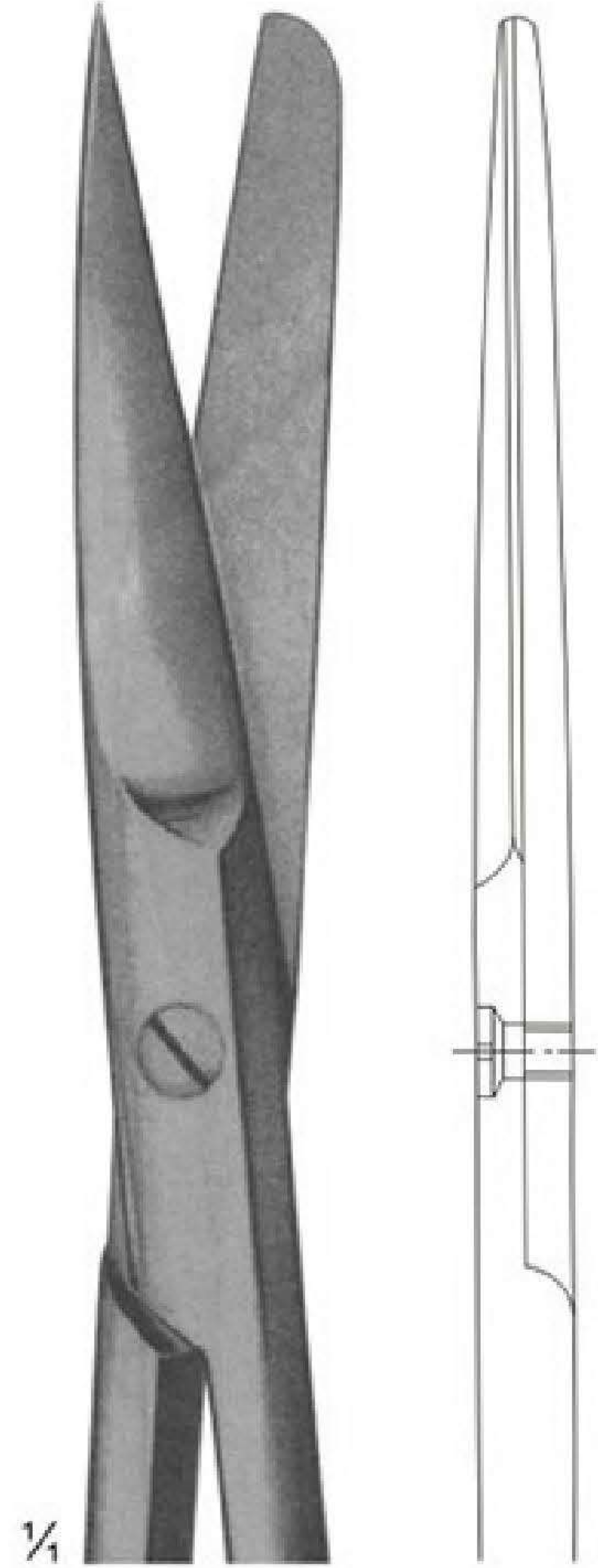

02-3103
 Size: 145 mm

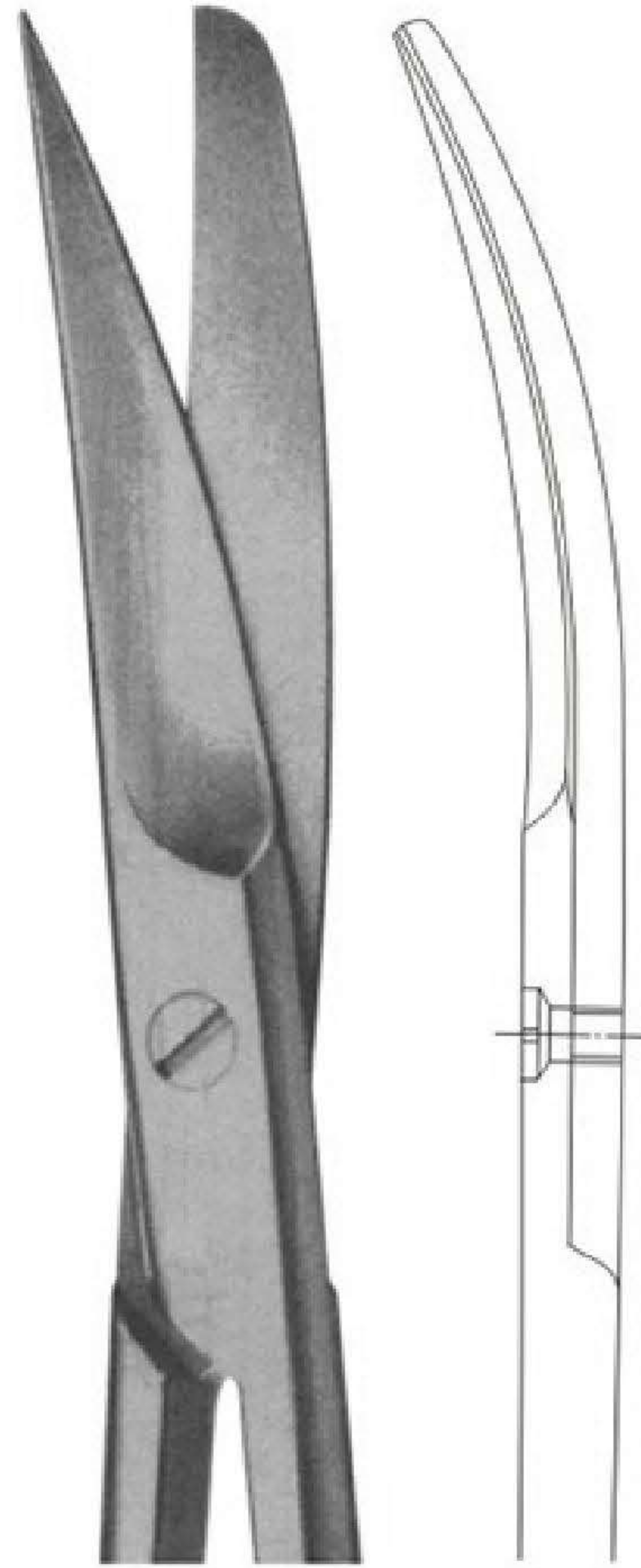

02-3104
 Size: 145 mm

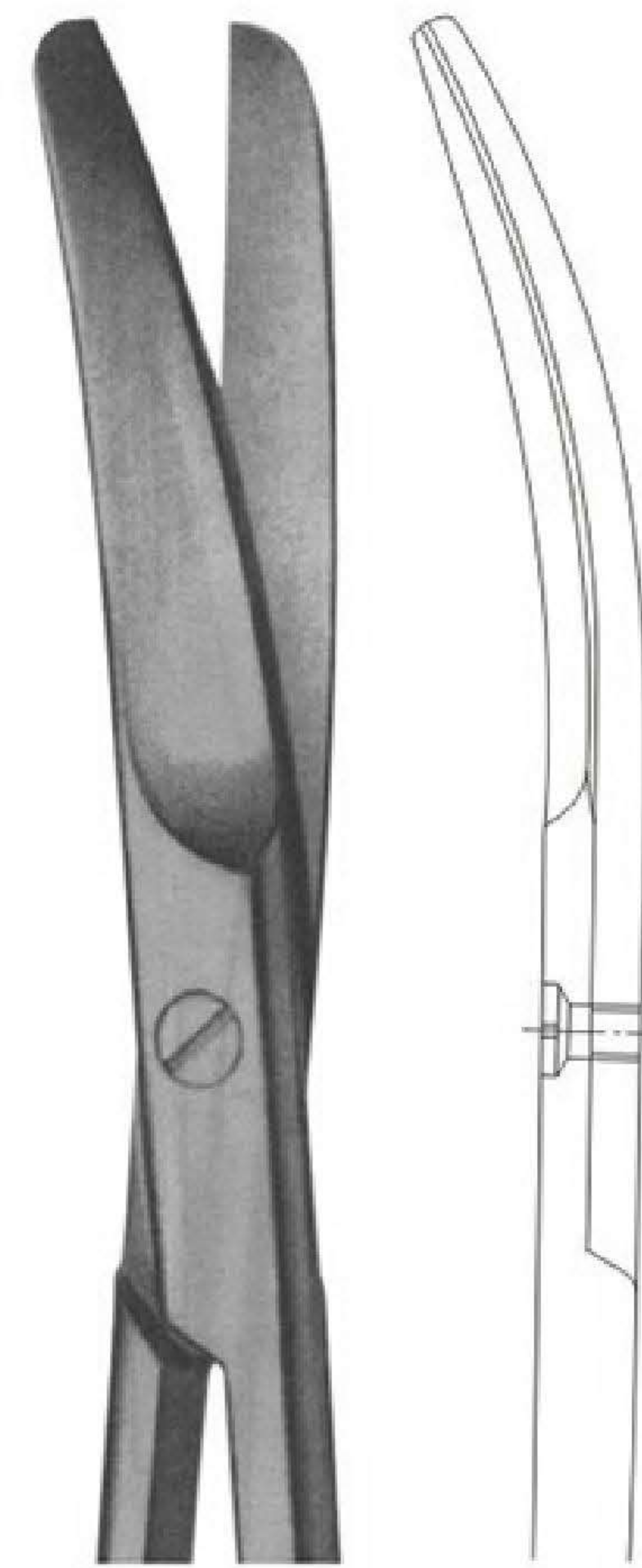

02-3105
 Size: 145 mm

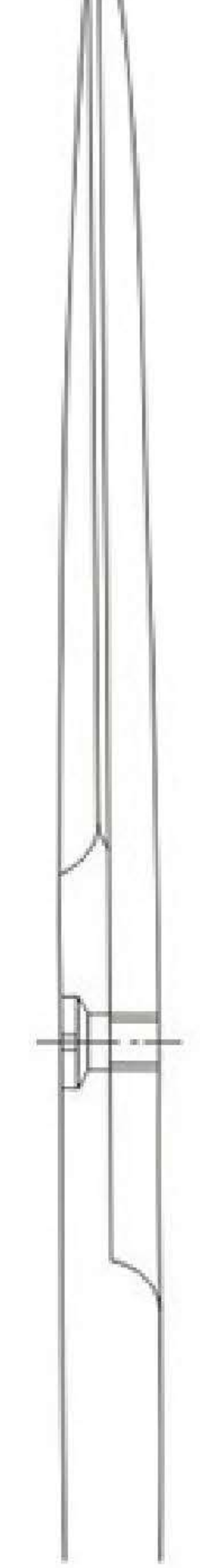

02-3106
 Size: 145 mm

02-3103 - 02-3106
 DEAVER
 With flat lock

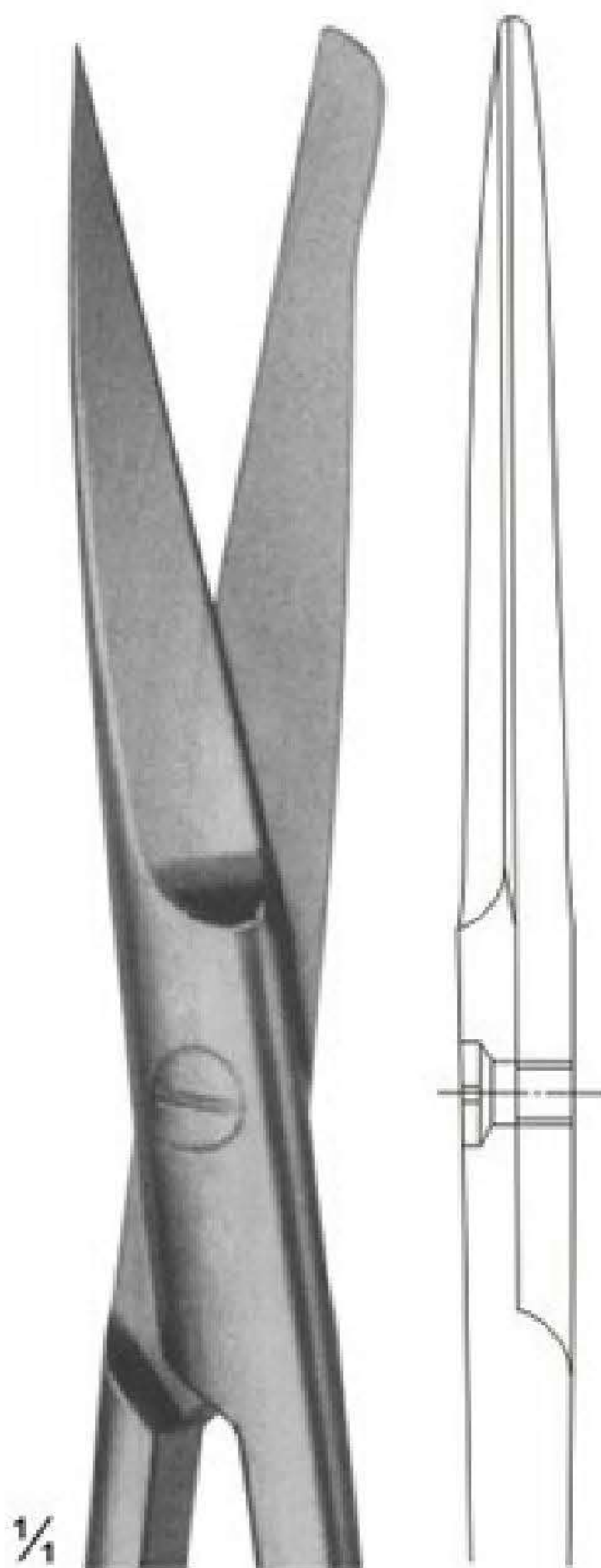

02-3107
 Size: 130 mm



02-3108
 Size: 145 mm

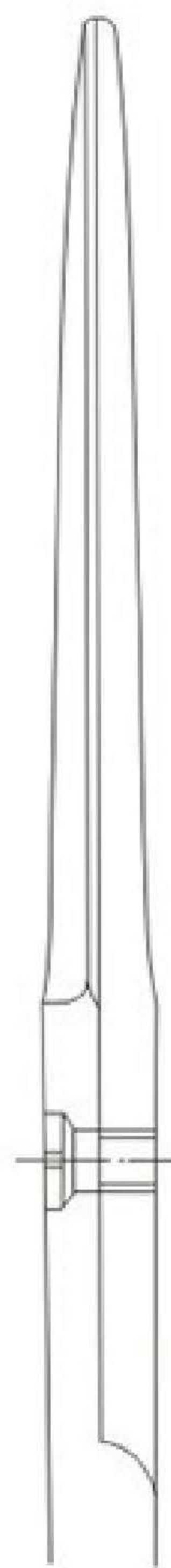

02-3109
 Size: 165 mm

02-3107 - 02-3109
 Incision Scissors

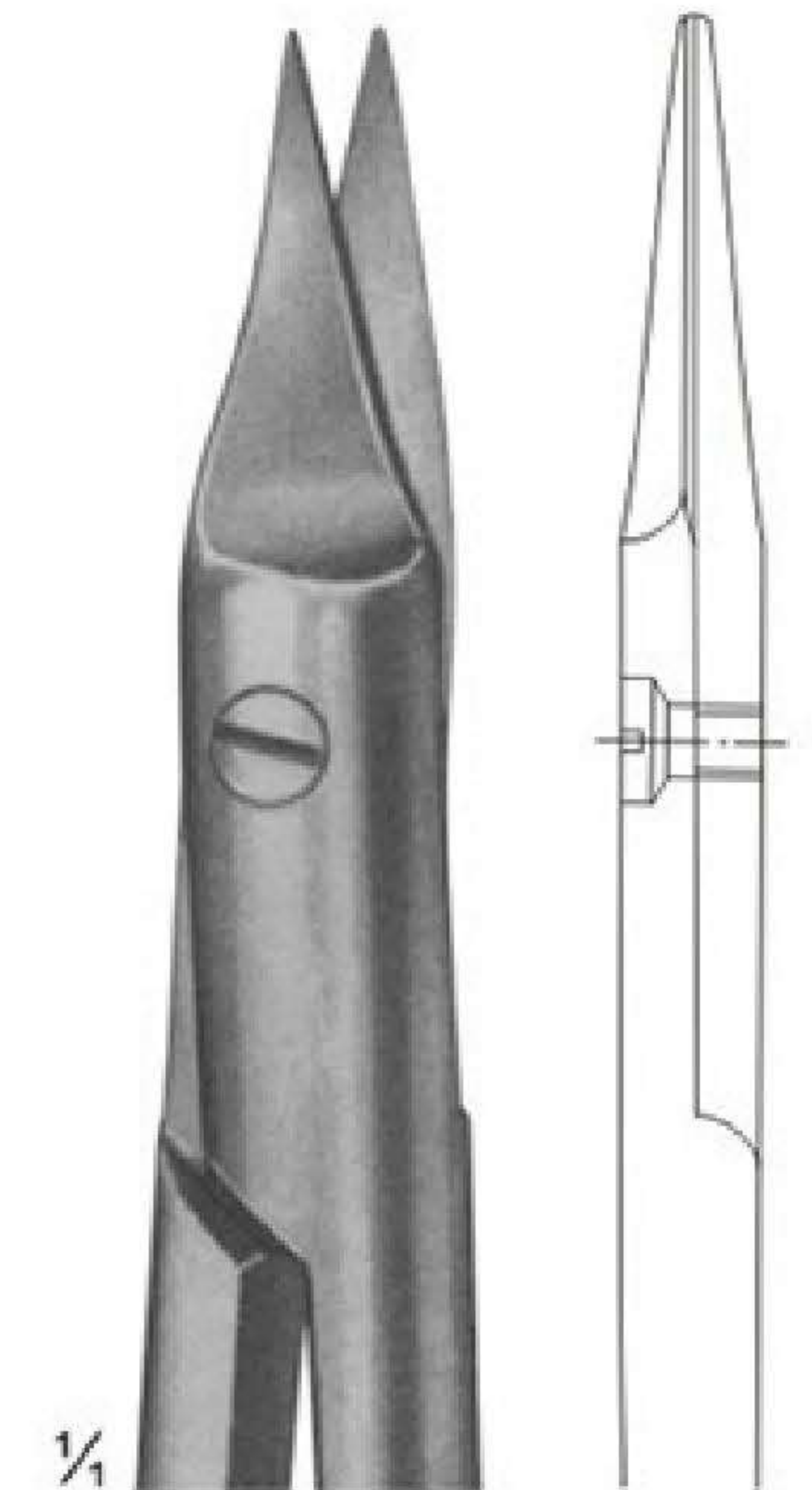
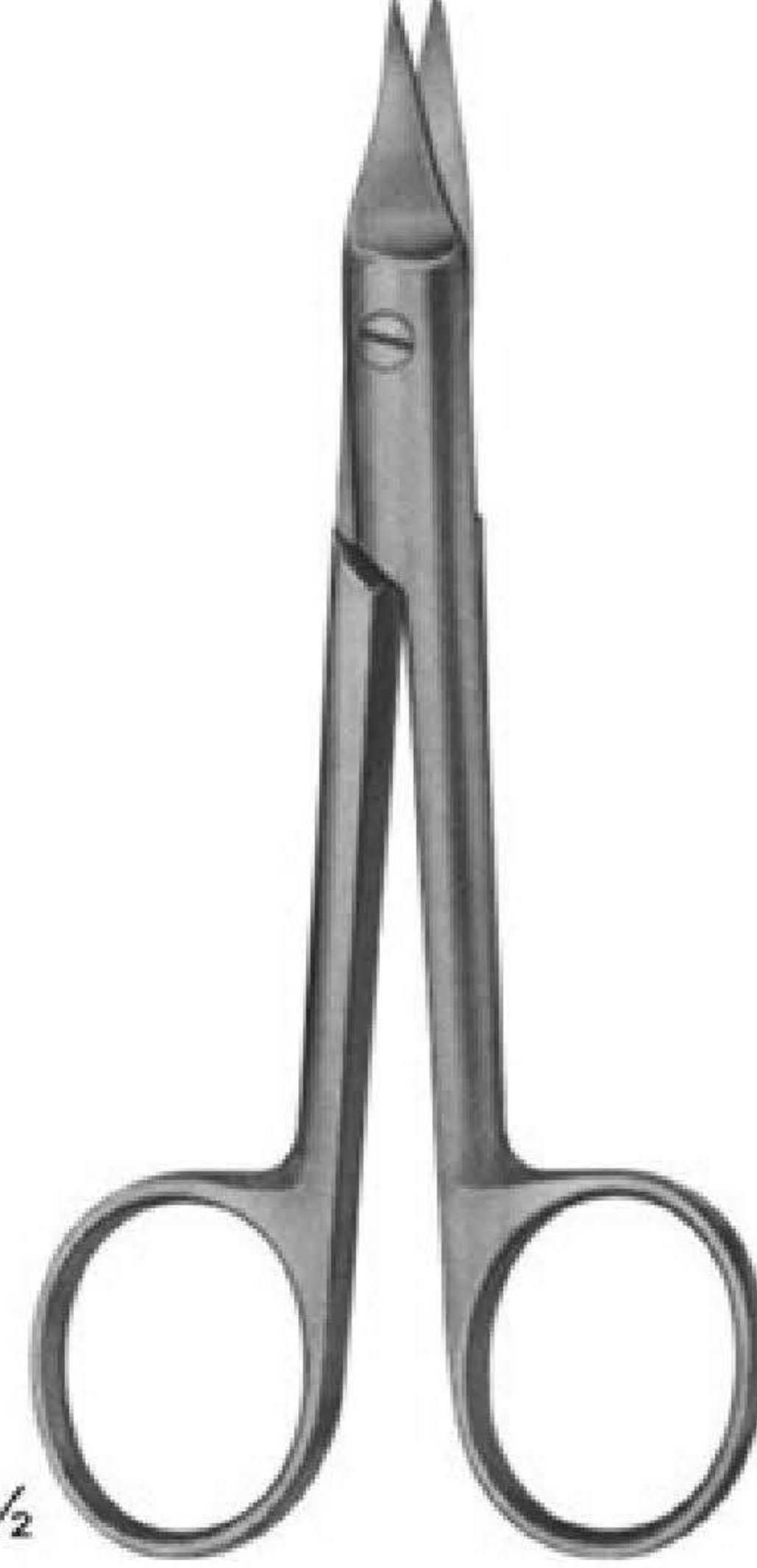

02-3110
 Size: 130 mm

02-3110
 SYSTRUNK
 Nail Splitting Scissors

Dissecting Scissors

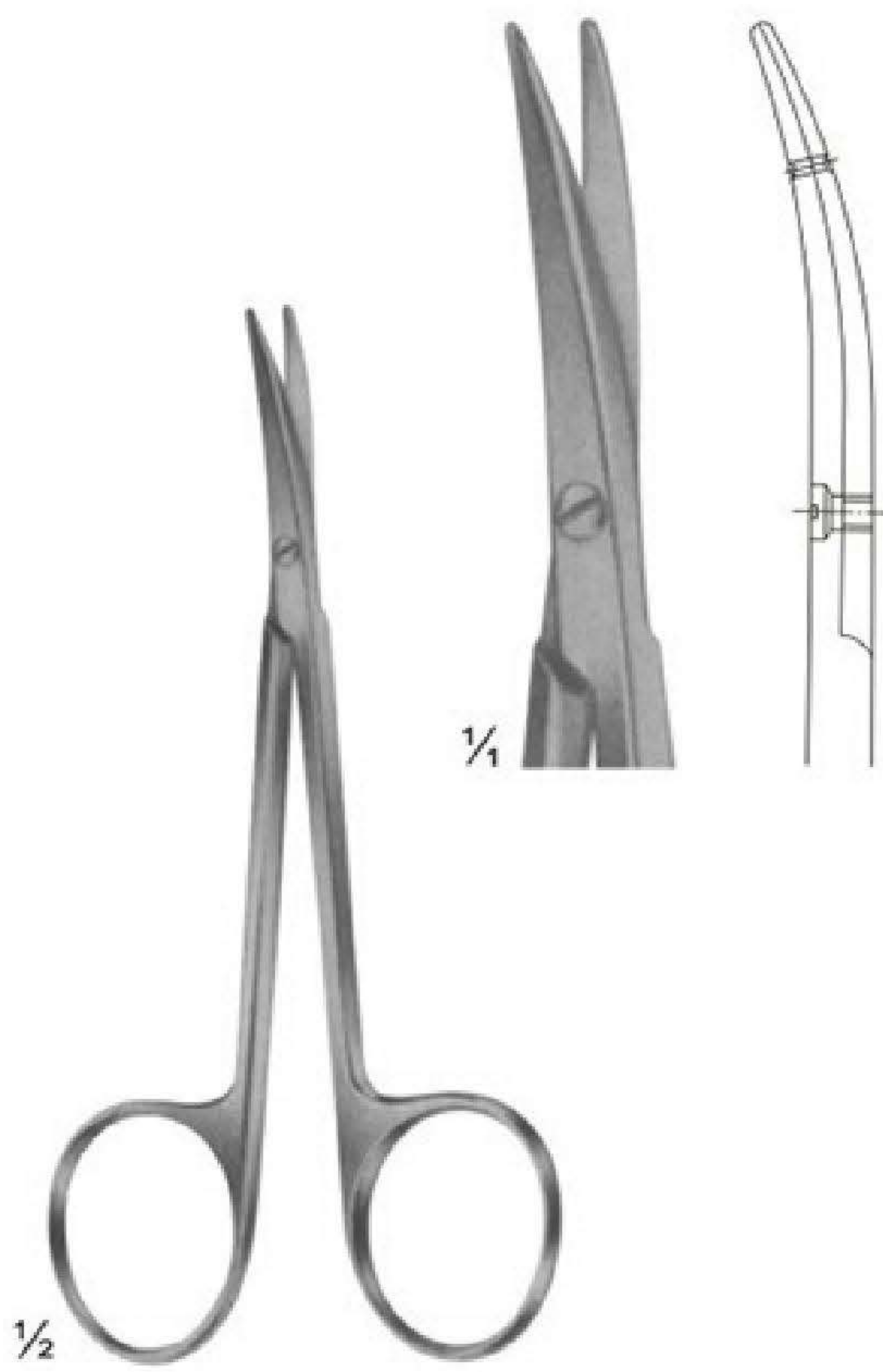

02-3111
LITTLER
Dissecting Scissors
Tips with eye for suture
Size: 115 mm

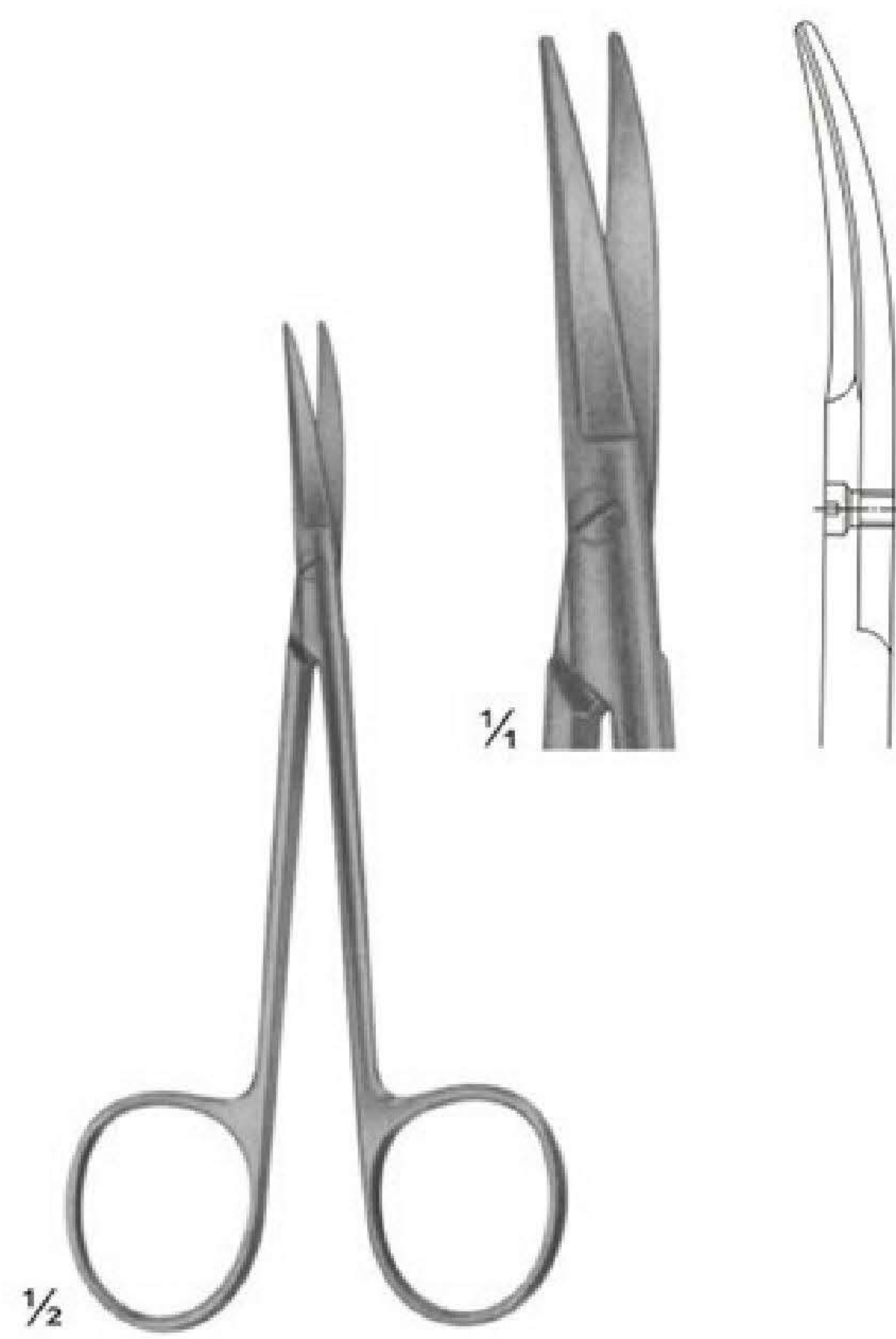

02-3112
COTTLE
Bulldog Scissors
Size: 115 mm



02-3113 - 02-3114
STEVENS
Vessel and tendon Scissors
Size: 100 mm

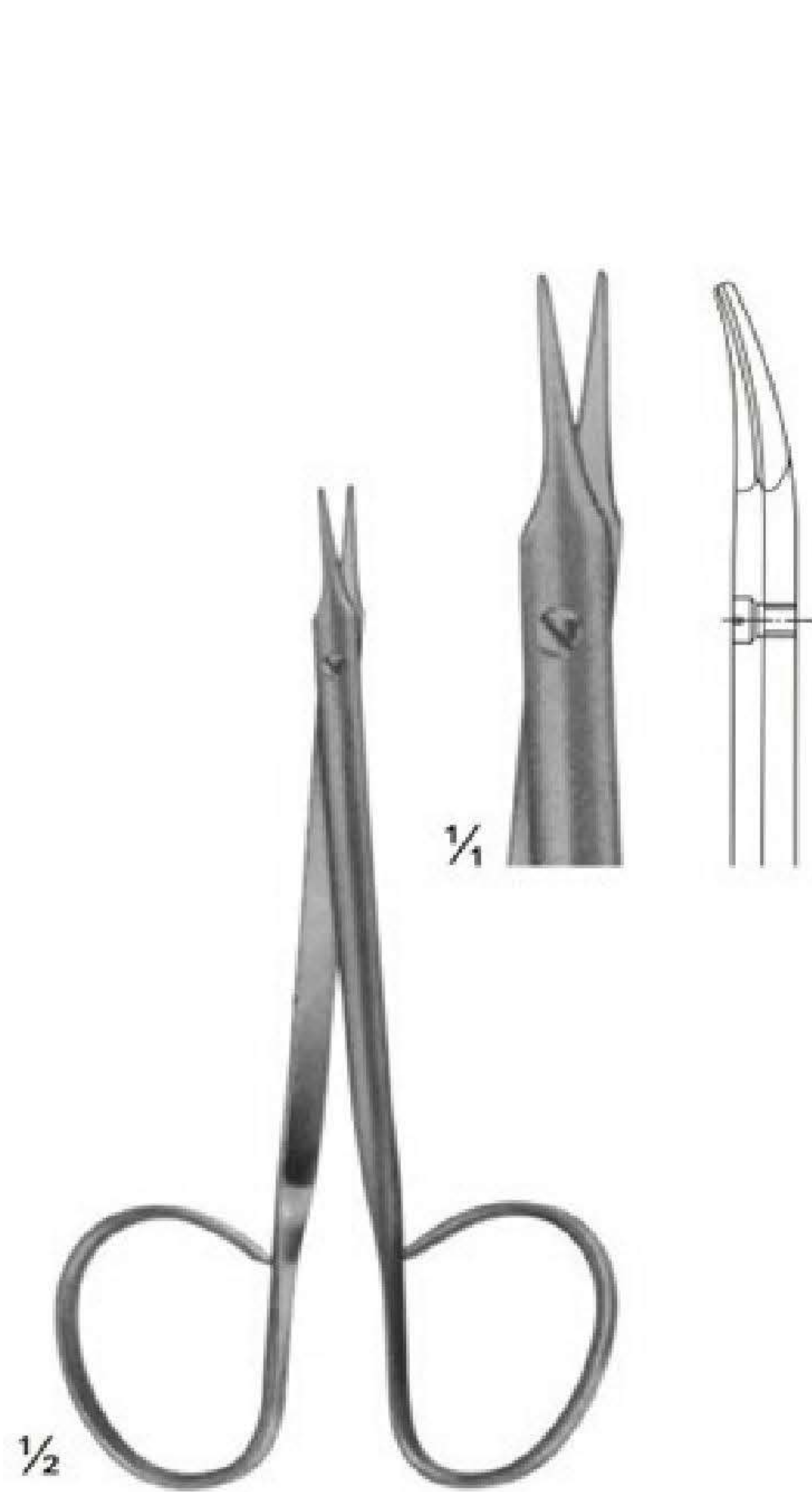

02-3115
STEVENS
Fine Dissecting Scissors
Size: 110 mm

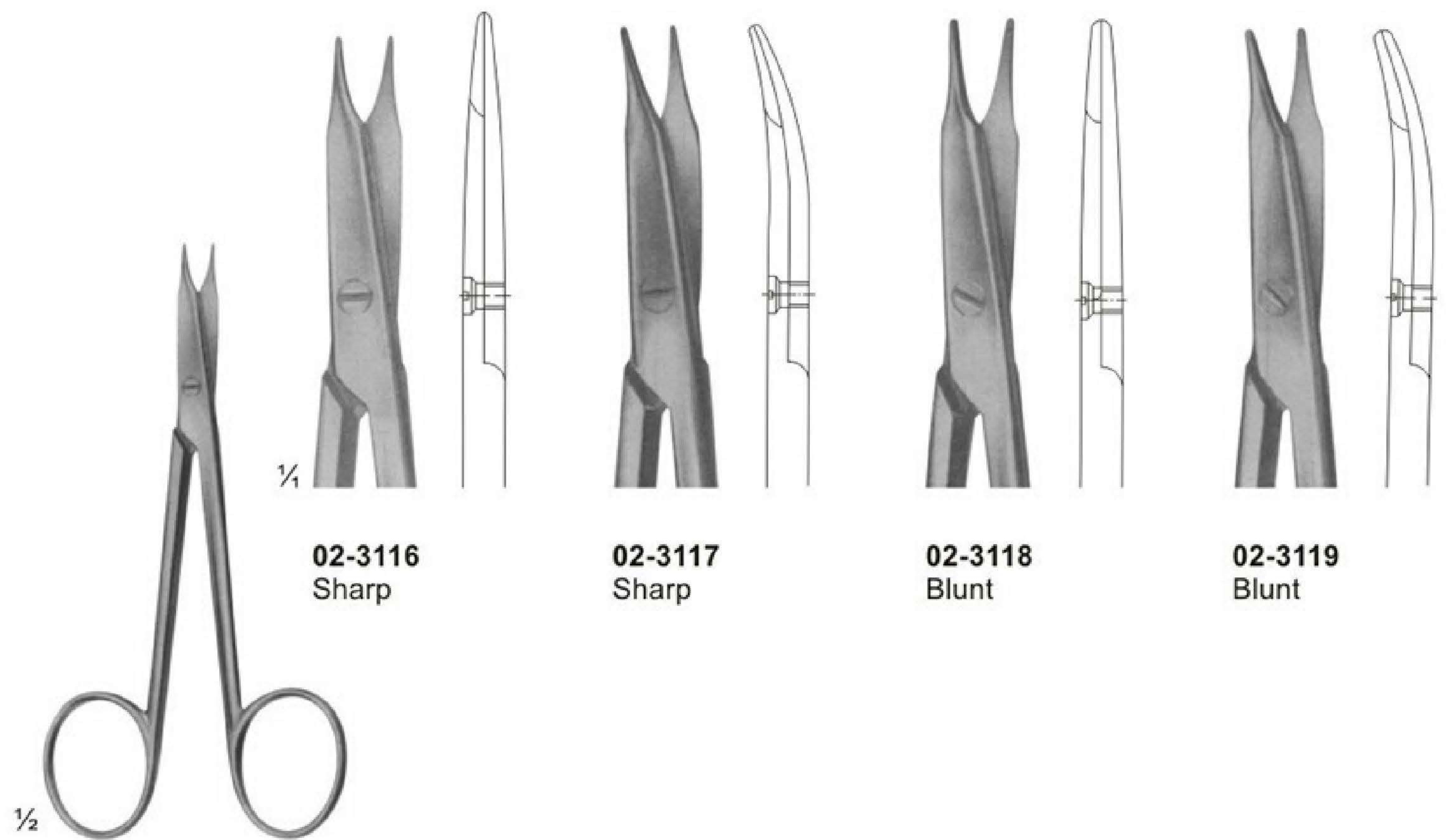

02-3116 - 02-3119
STEVENS
Vessel and tendon Scissors
Size: 110 mm

Dissecting Scissors

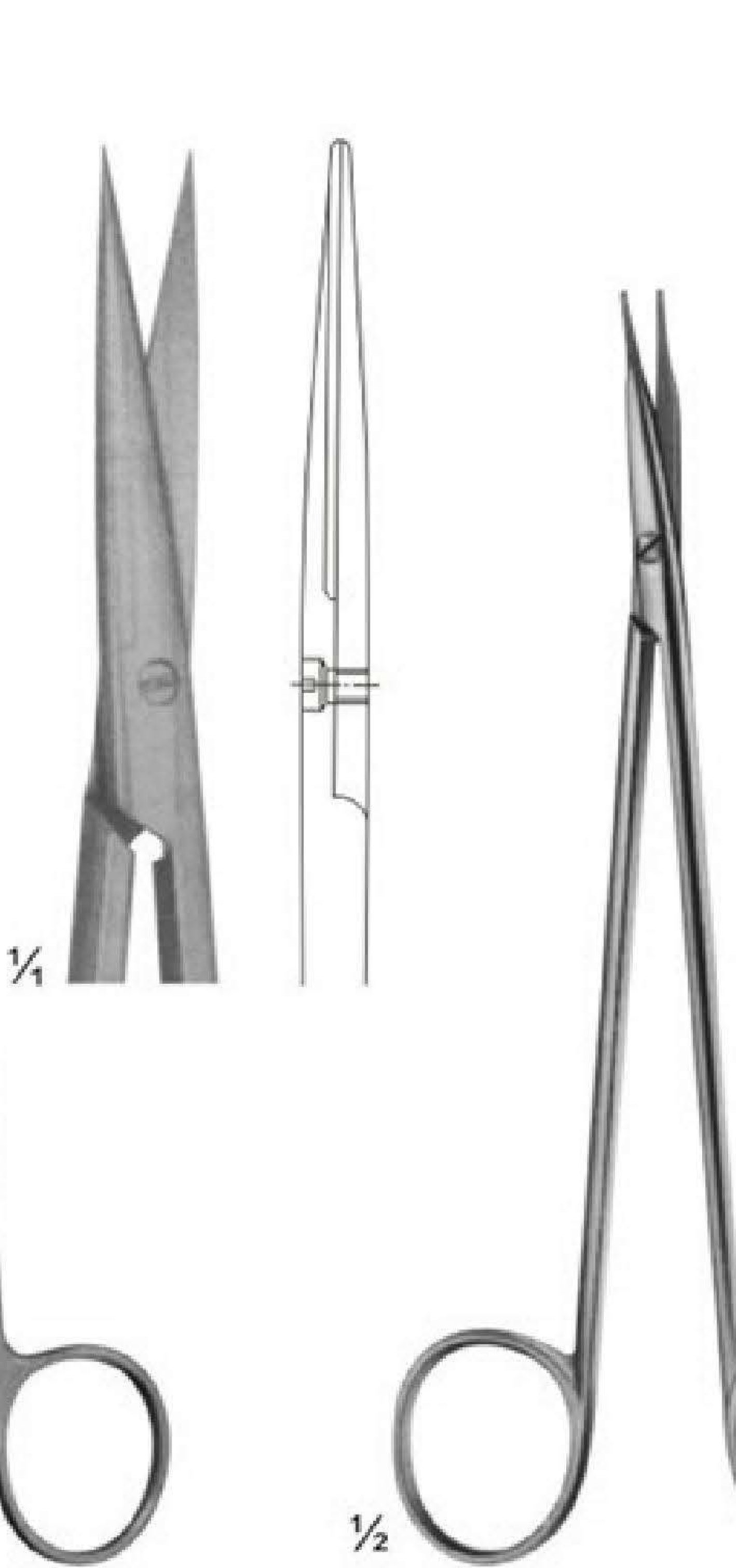
 <p>1/2</p> <p>1/4</p> <p>02-3120 Size: 125 mm</p> <p>02-3121 Size: 150 mm</p>	 <p>1/2</p> <p>02-3122 KILNER Fine dissecting scissors Size: 115 mm</p>	 <p>1/2</p> <p>02-3123 JAMESON Dissecting scissors Size: 150 mm</p>	 <p>1/2</p> <p>02-3124 REYNOLDS Dissecting scissors</p> <p>145 mm 175 mm</p> <p>1/4</p> <p>02-3125 DE BAKEY Ateriotomy scissors Size: 175 mm</p> <p>02-3126 Very delicate</p> <p>02-3127 Delicate</p> <p>02-3128 Very delicate</p> <p>02-3129 Delicate</p> <p>02-3130 Delicate</p>
<p>02-3120 - 02-3121 KILNER Special flat points for dissecting and undermining the skin</p>	<p>02-3126 - 02-3127 TOENNIS - ADSON Dissecting scissors Size: 175 mm</p>	<p>02-3128 - 02-3130 TOENNIS Dissecting scissors Size: 180 mm</p>	

Dissecting & Surgical Scissors



02-3131
Size: 115 mm

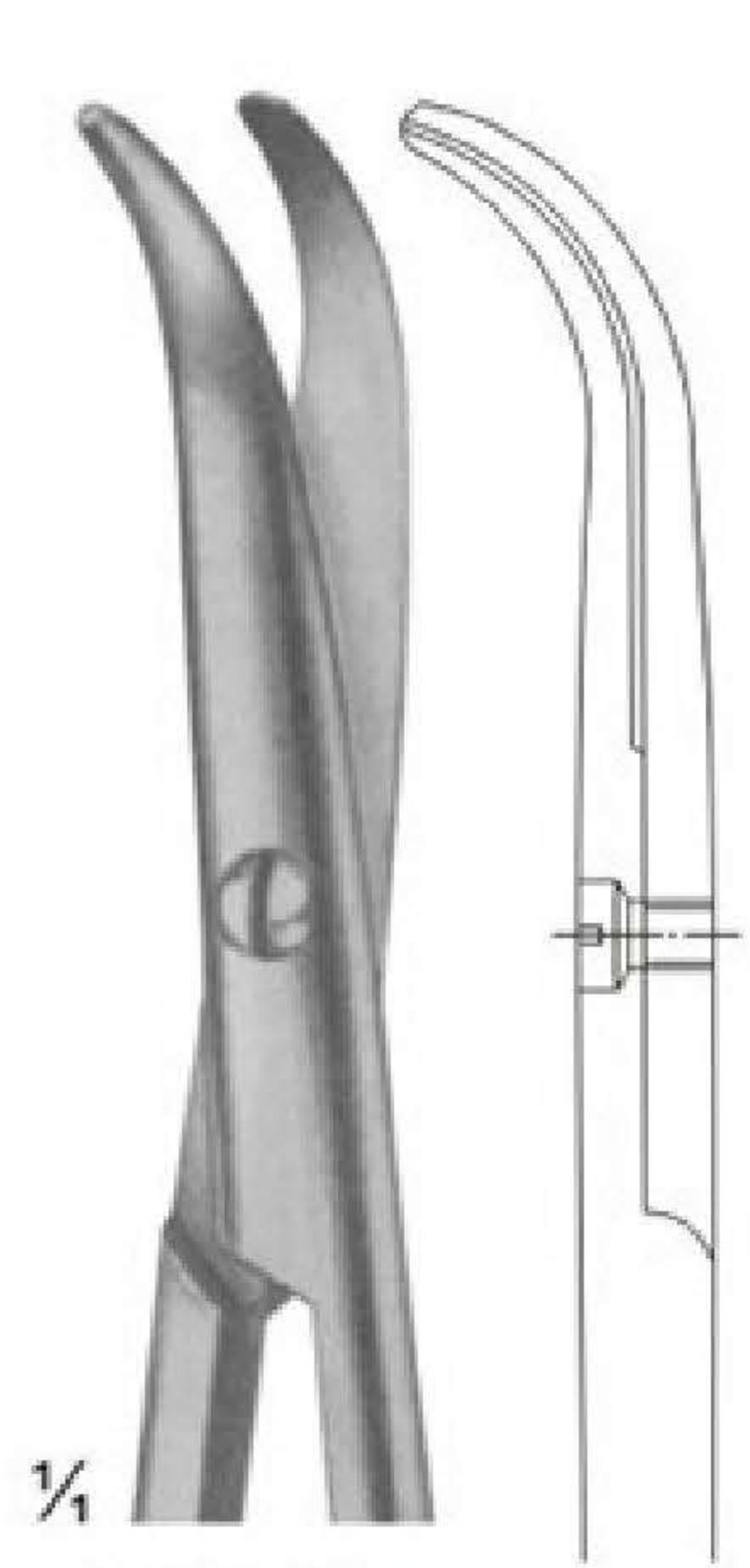

02-3132
Size: 135 mm

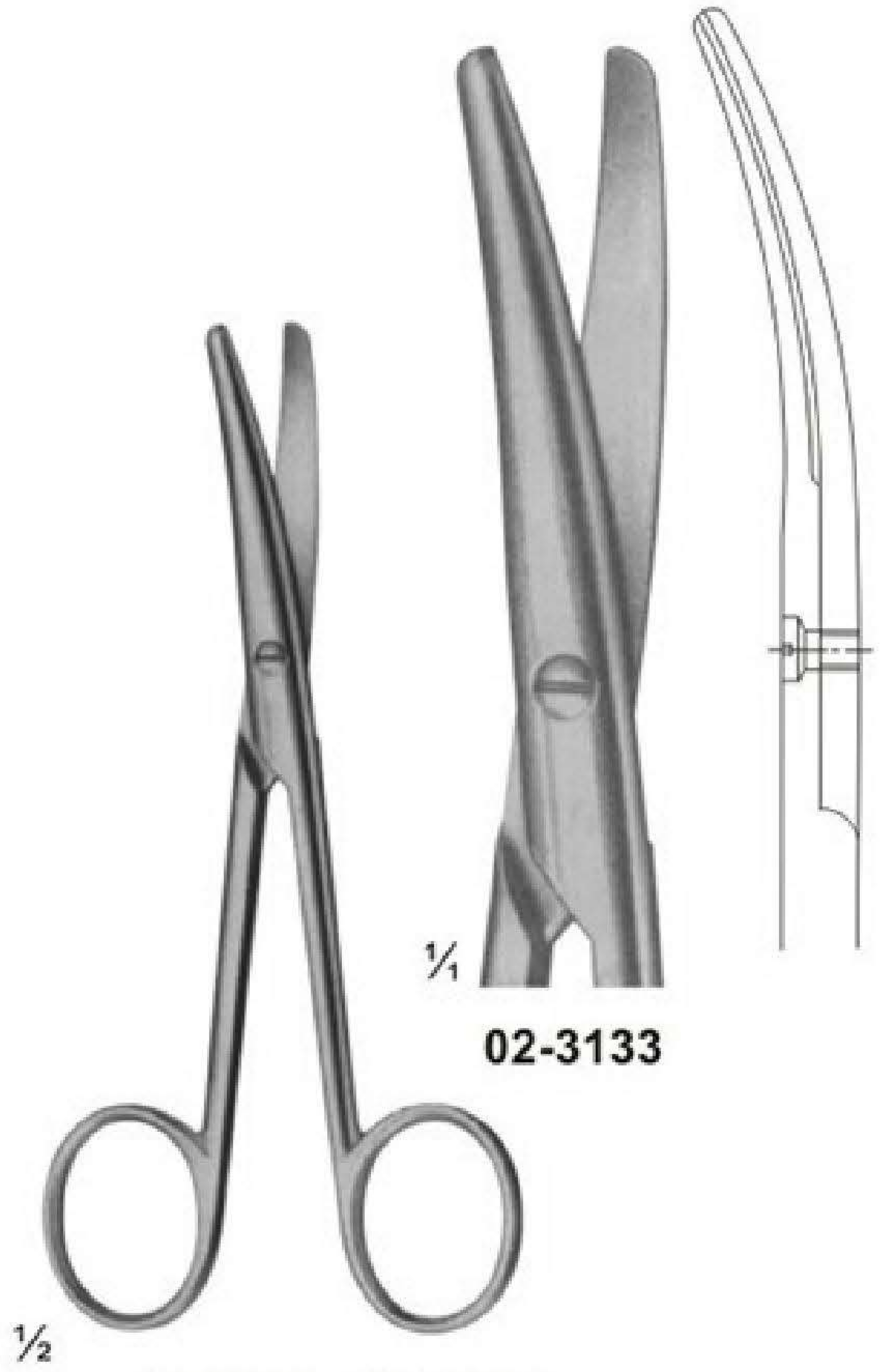

02-3133

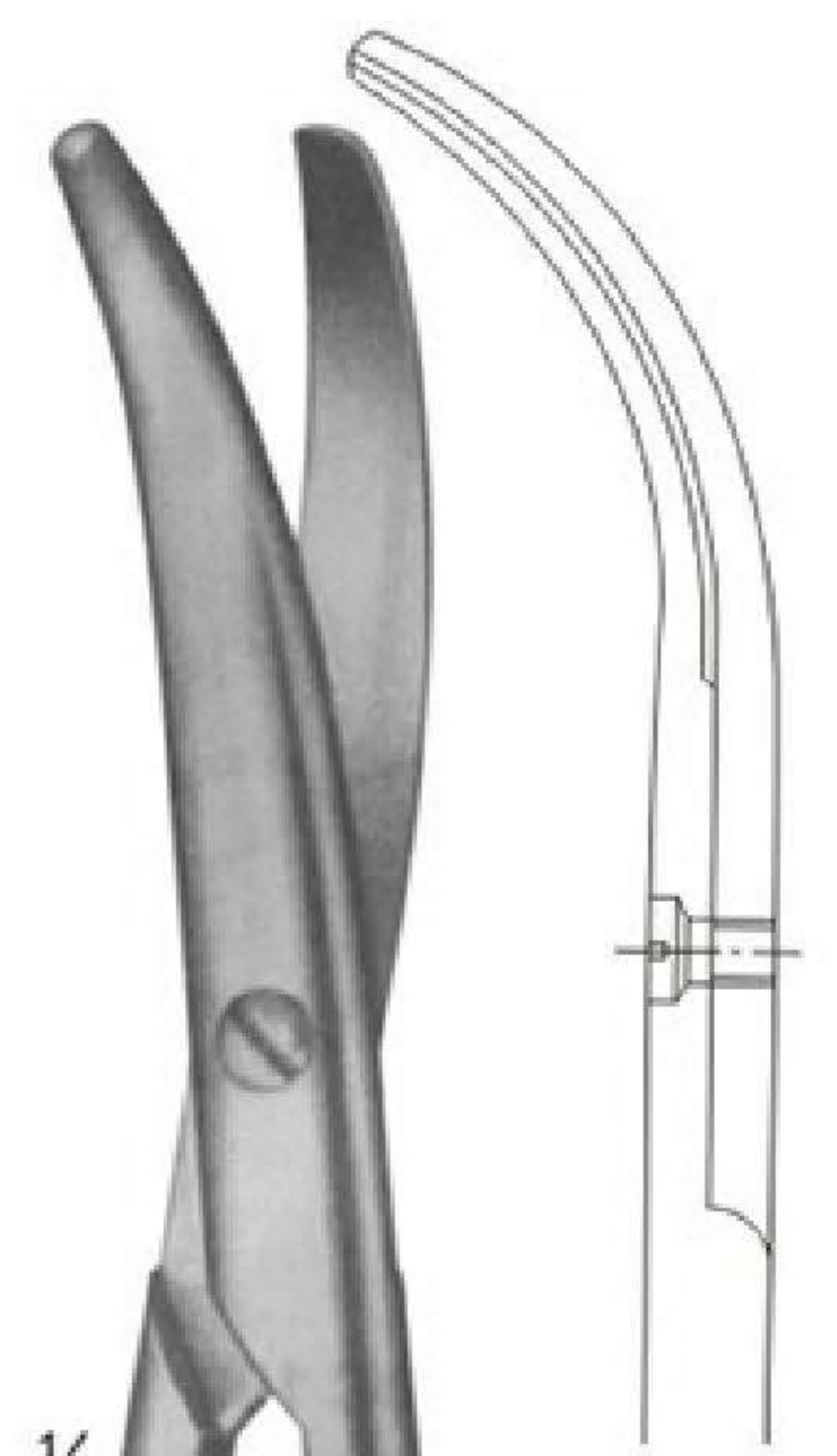

02-3134

02-3131 - 02-3132
FOMON
Lower lateral scissors

02-3133 - 02-3134
LANDOLT
Enucleation scissors
Size: 120 mm

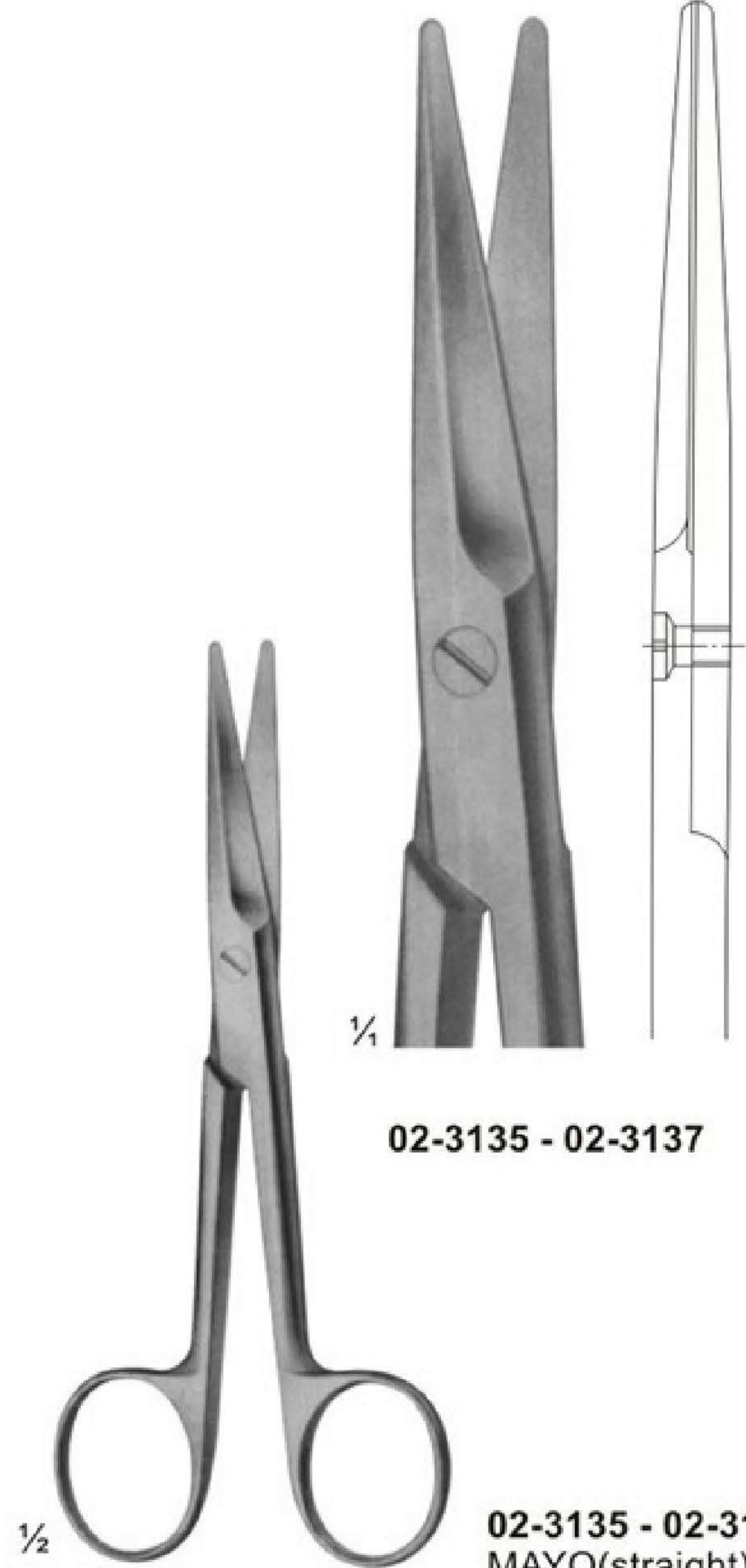

02-3135 - 02-3137
MAYO(straight)
02-3135 (140 mm)
02-3136(155 mm)
02-3137 (170 mm)

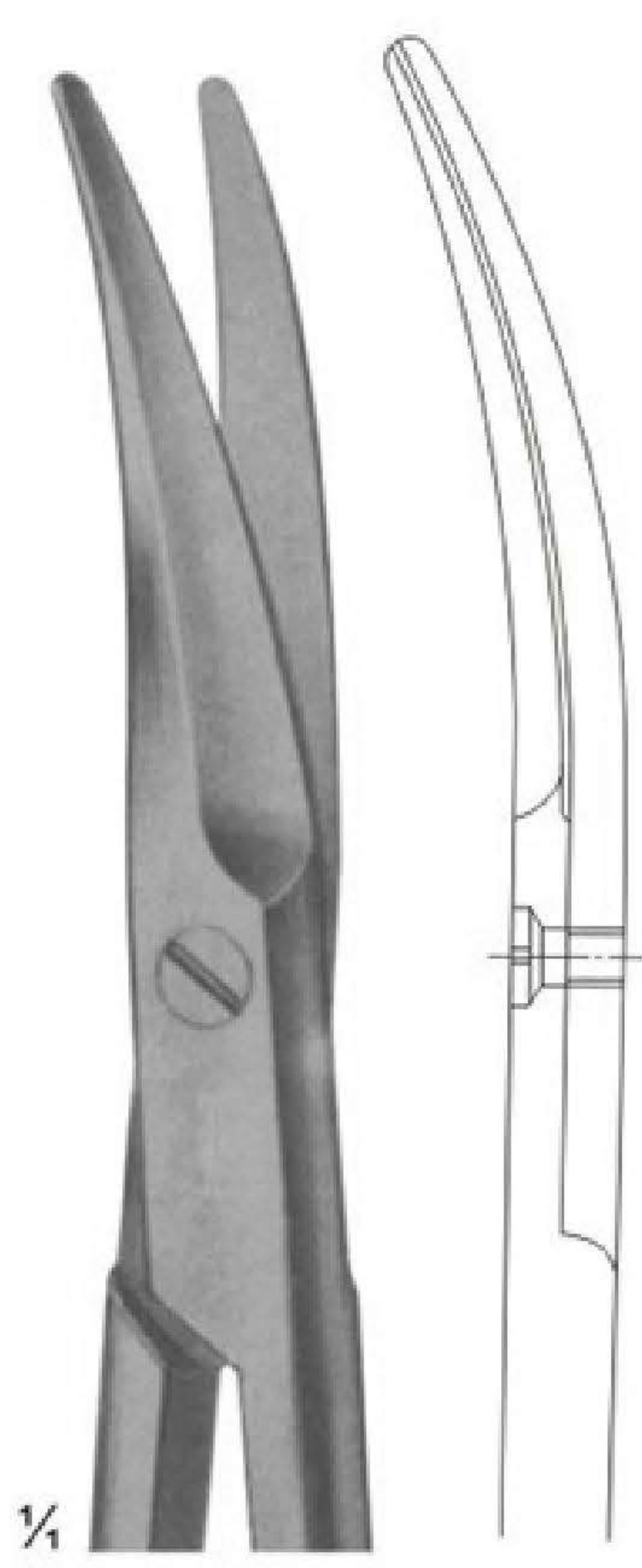

02-3138 - 02-3140
MAYO(curved)
02-3138 (140 mm)
02-3139 (155 mm)
02-3140 (170 mm)

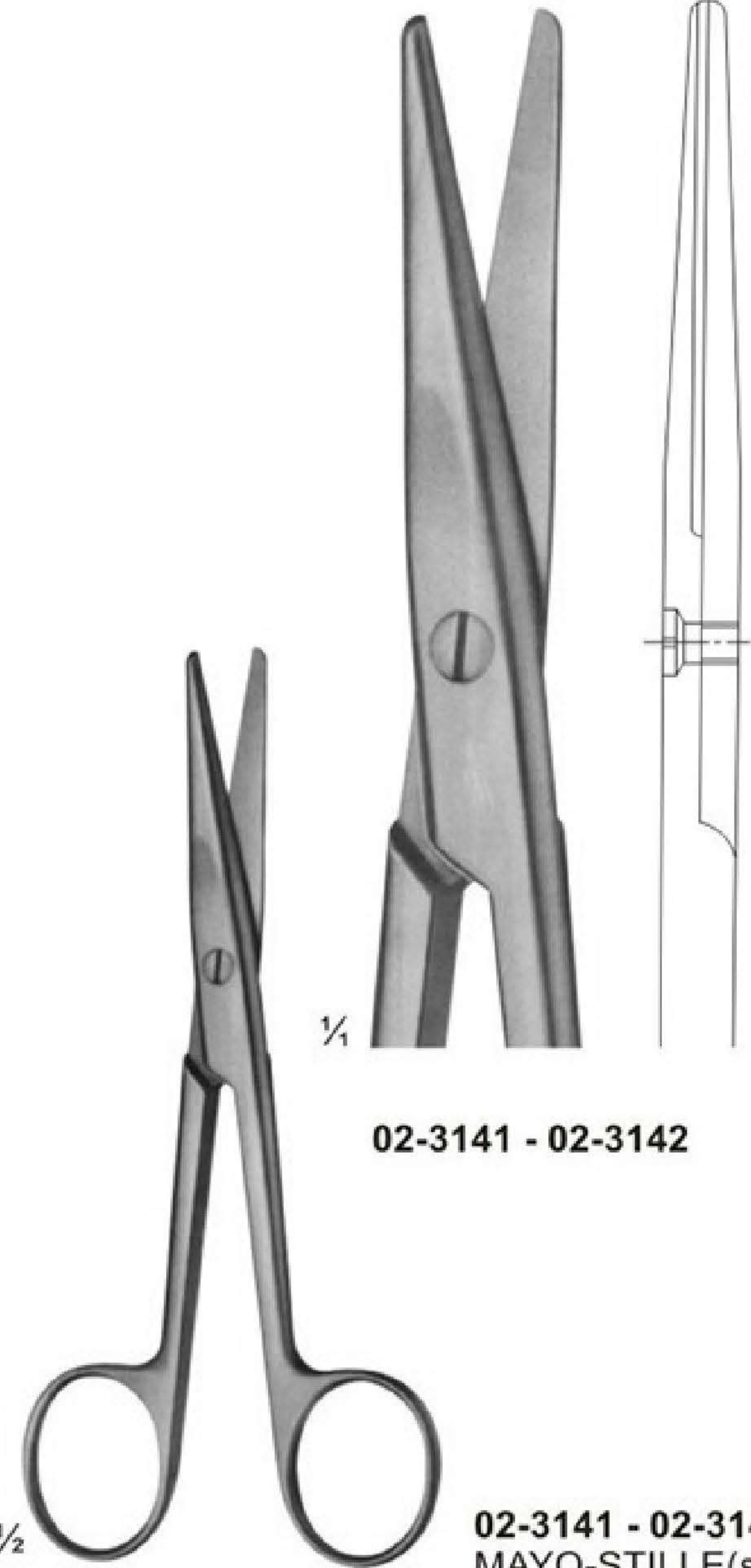

02-3141 - 02-3142
MAYO-STILLE(straight)
02-3141 (140 mm)
02-3142 (170 mm)

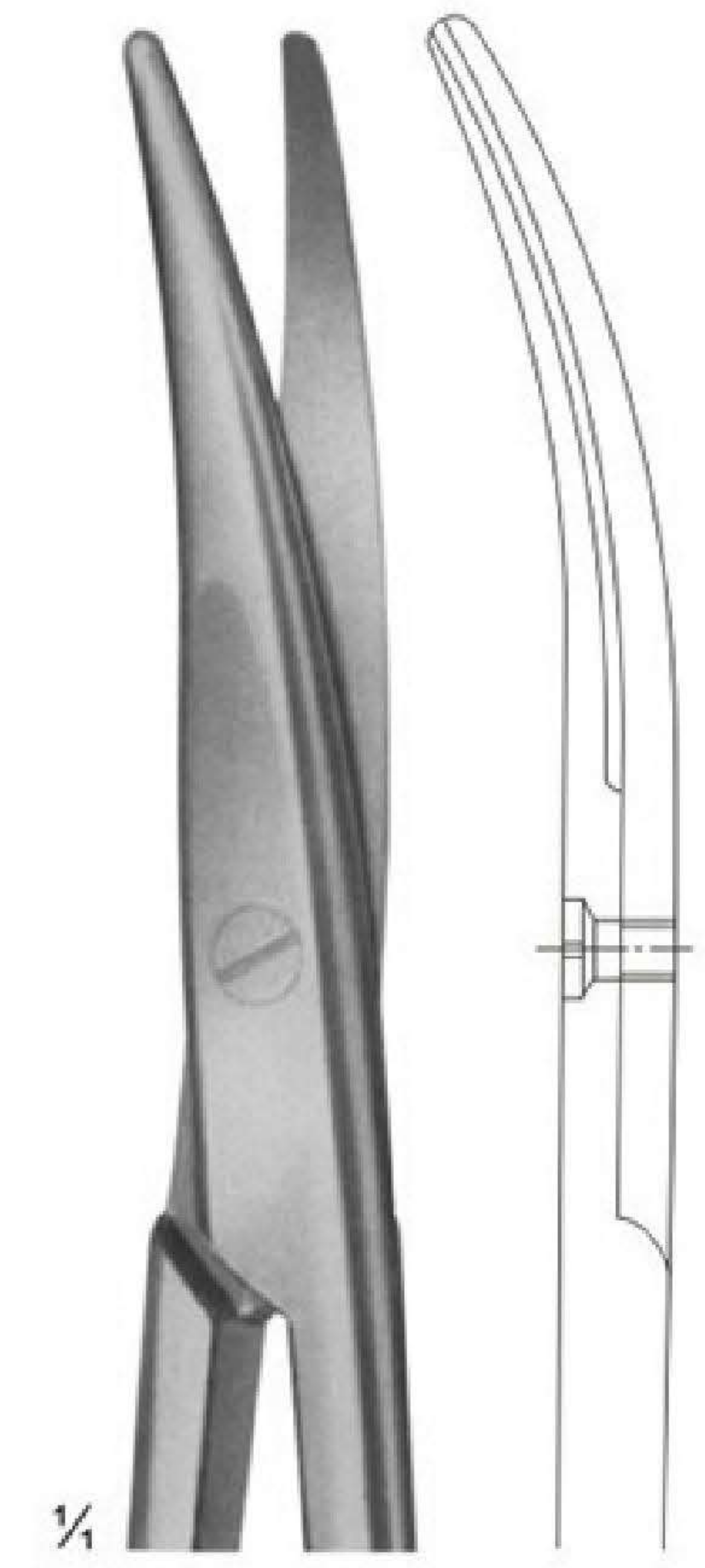

02-3143 - 02-3144
MAYO-STILLE(curved)
02-3143 (140 mm)
02-3144 (170 mm)

Dissecting Scissors

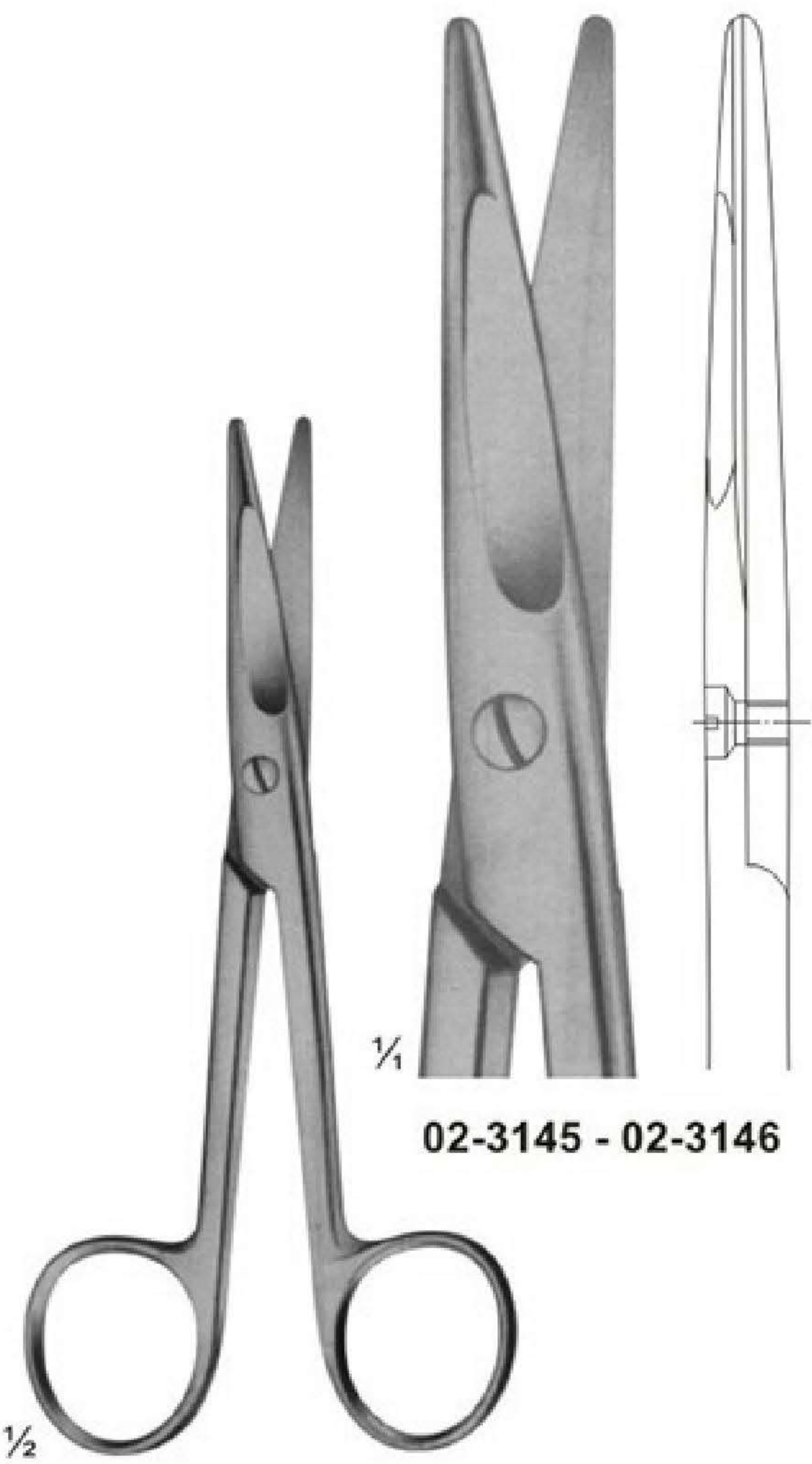

02-3145 - 02-3146

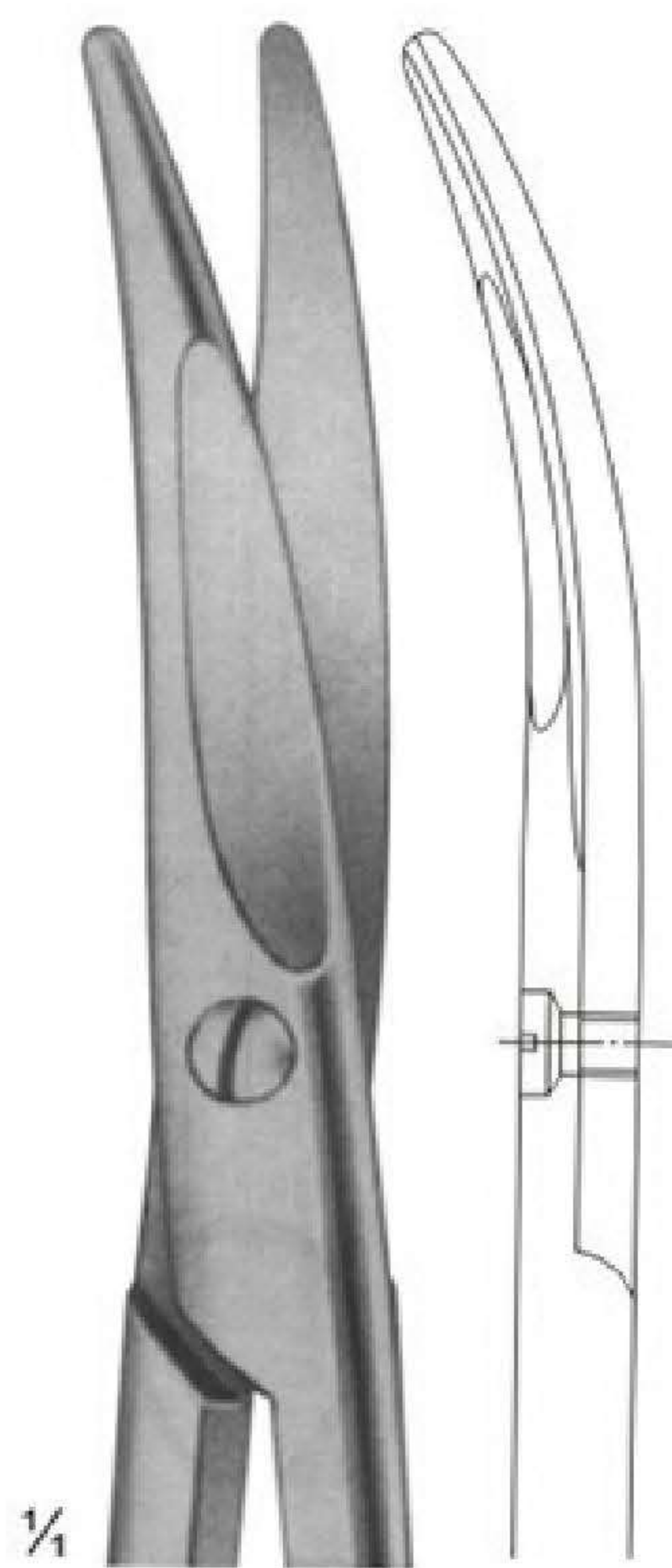

MAYO-STILLE
02-3147 - 02-3148
02-3147 (14cm)
02-3148 (17cm)

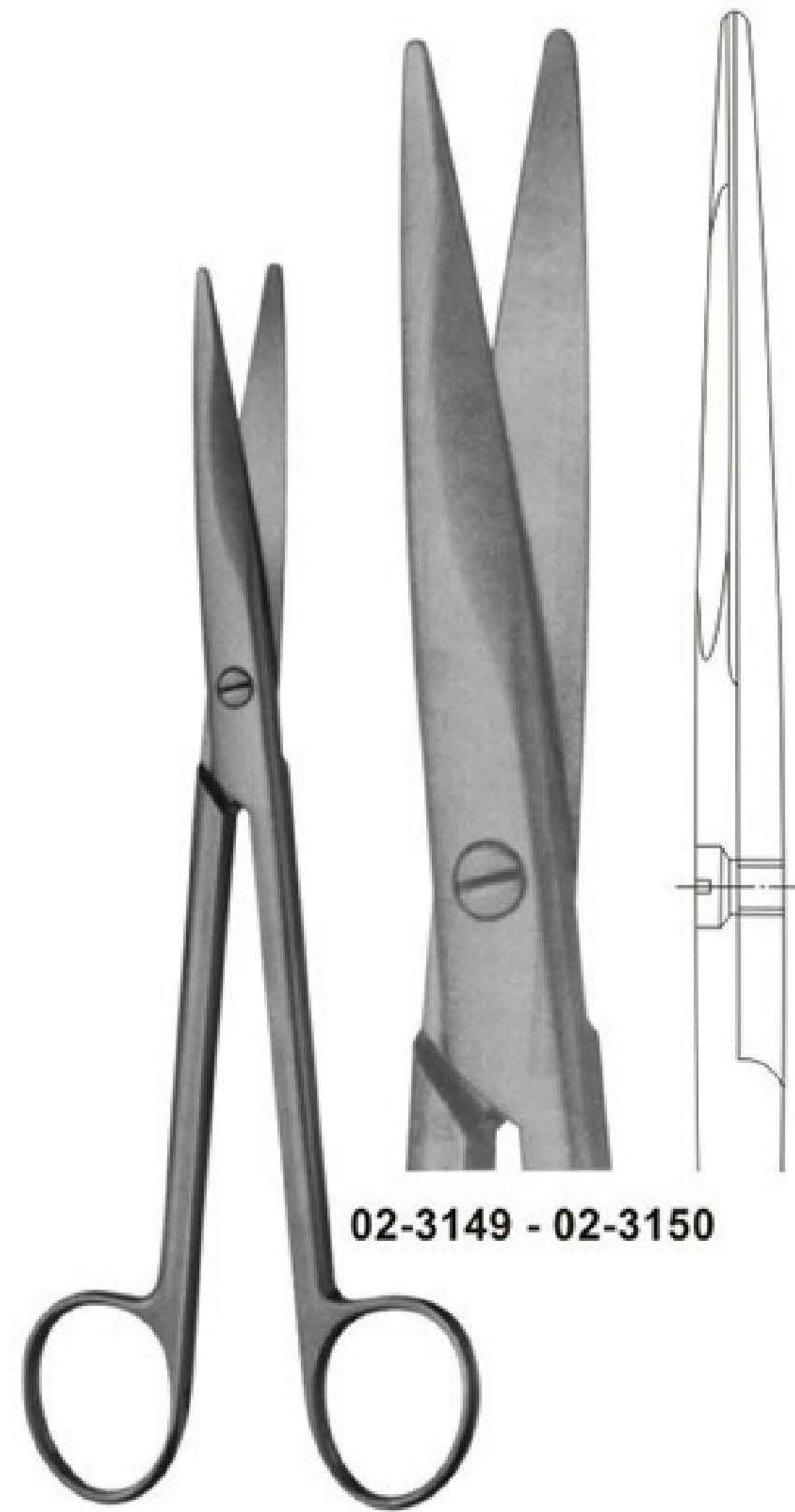

02-3149 - 02-3150

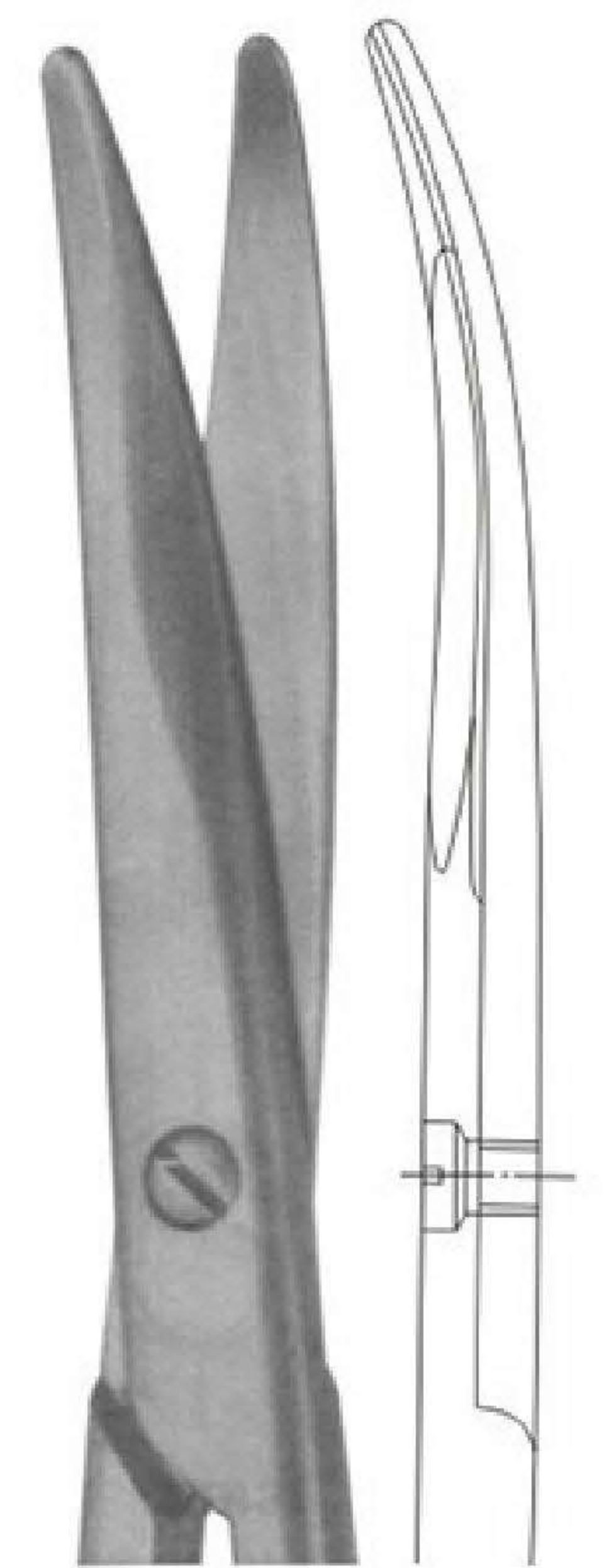

MAYO
02-3151
Size: 190 mm
02-3152
Size: 215 mm

02-3145 - 02-3146
MAYO-STILLE
With chamfered blades
02-3145 (140 mm)
02-3146 (170 mm)

MAYO
With chamfered blades
02-3149 (190 mm)
02-3150 (215 mm)

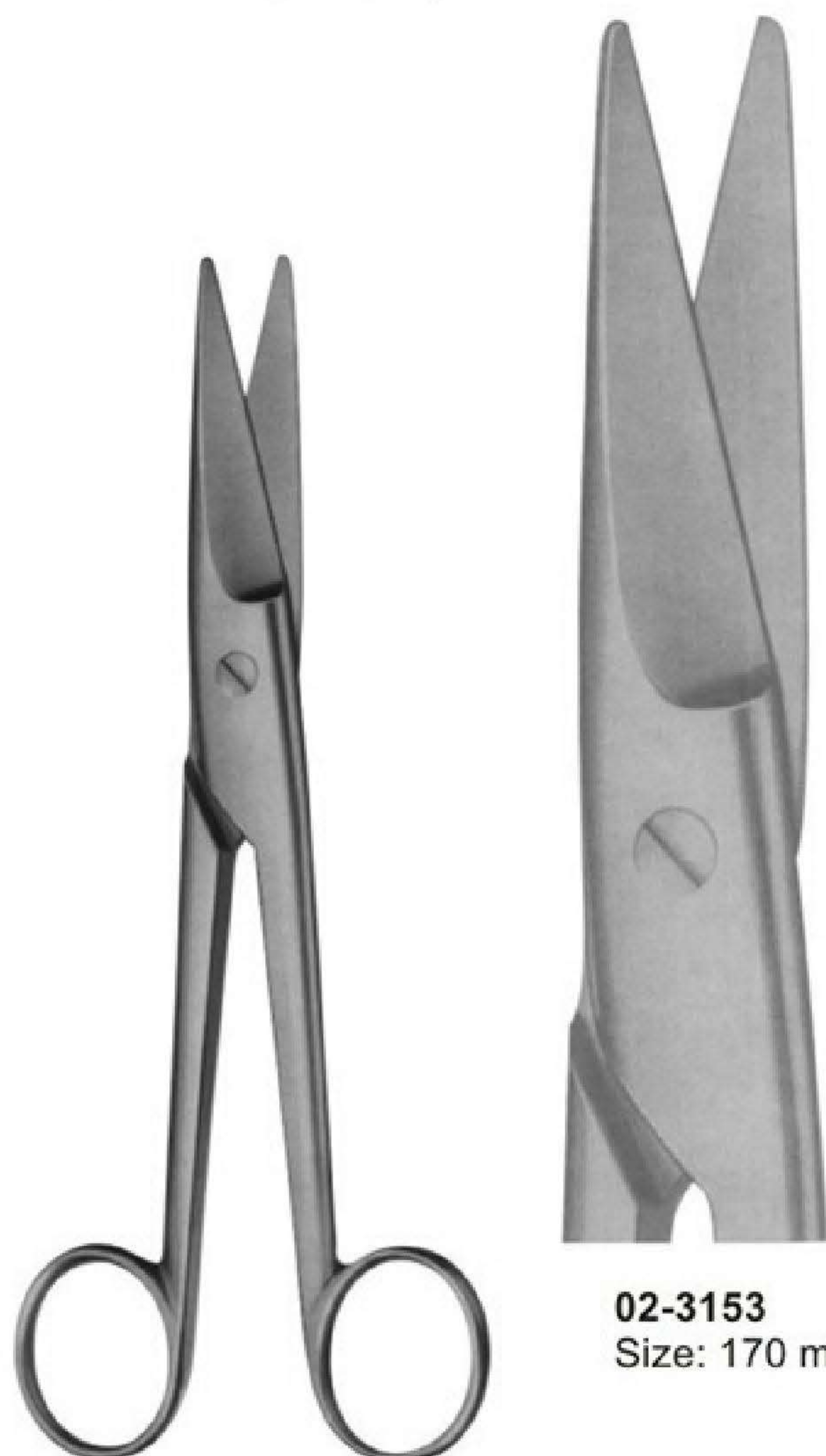

02-3153
Size: 170 mm

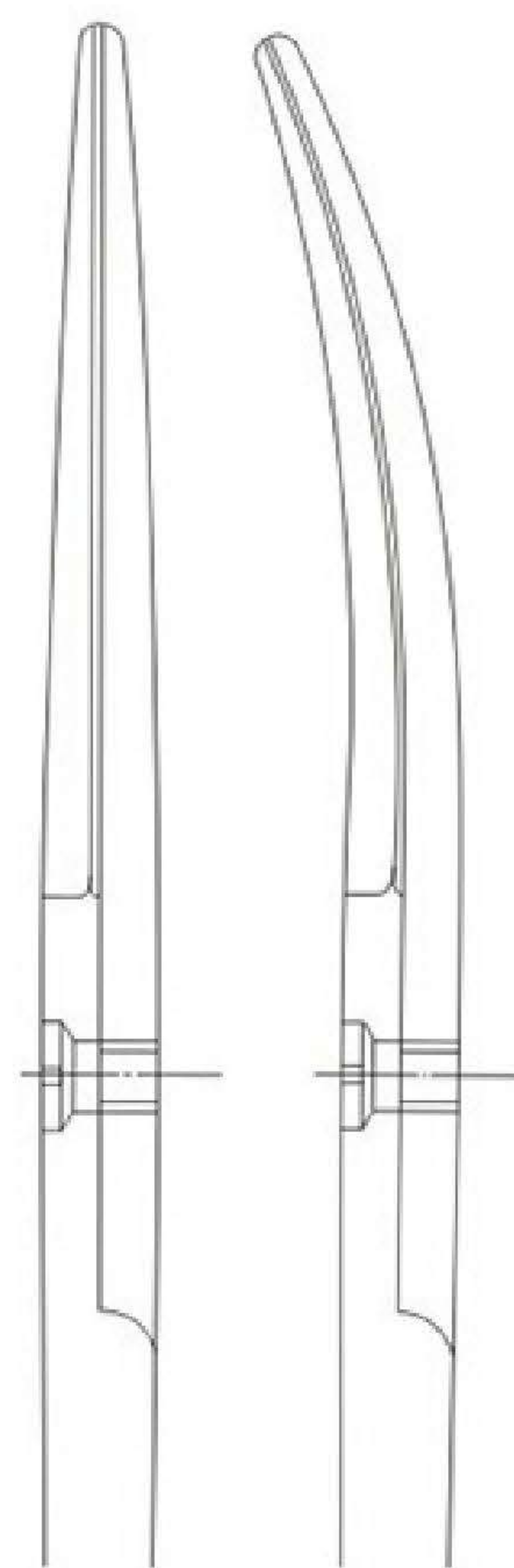

02-3154
Size: 170 mm

02-3153 - 02-3154
MAYO-NOBLE (Broad pattern)



02-3155 - 02-3156
MAYO-HARRINGTON

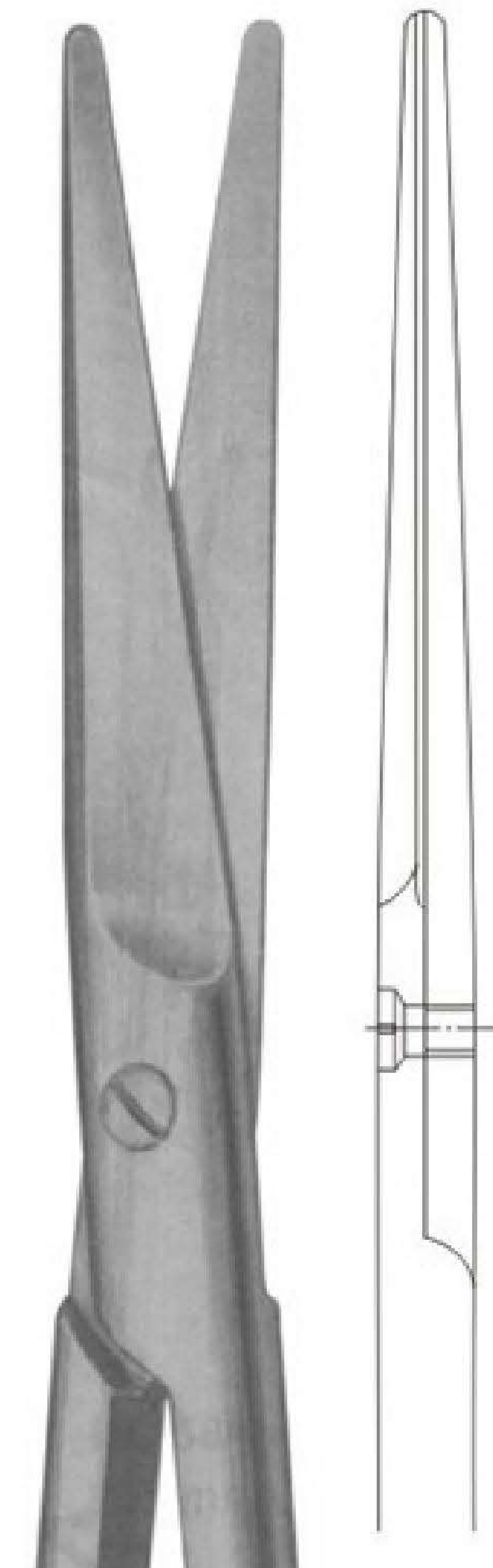

02-3155
Size: 230 mm

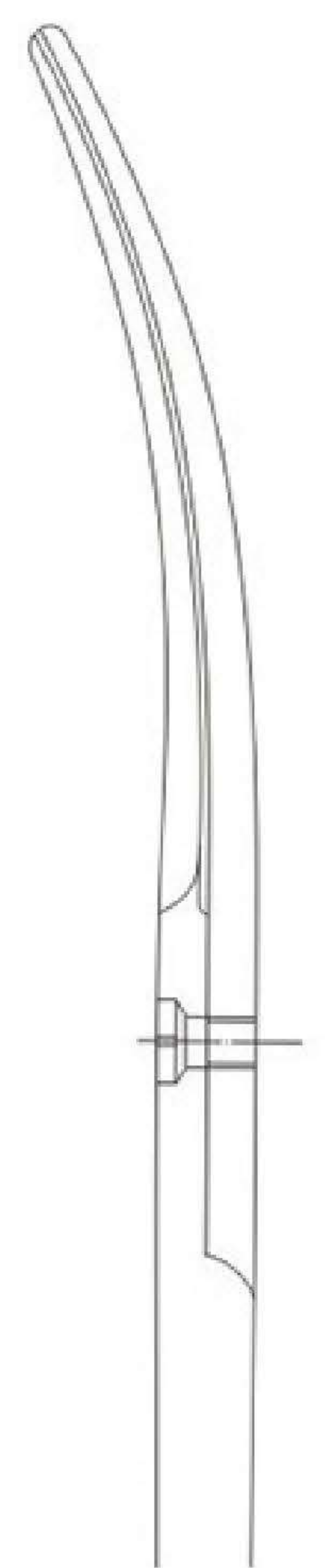

02-3156
Size: 230 mm

Dissecting Scissors

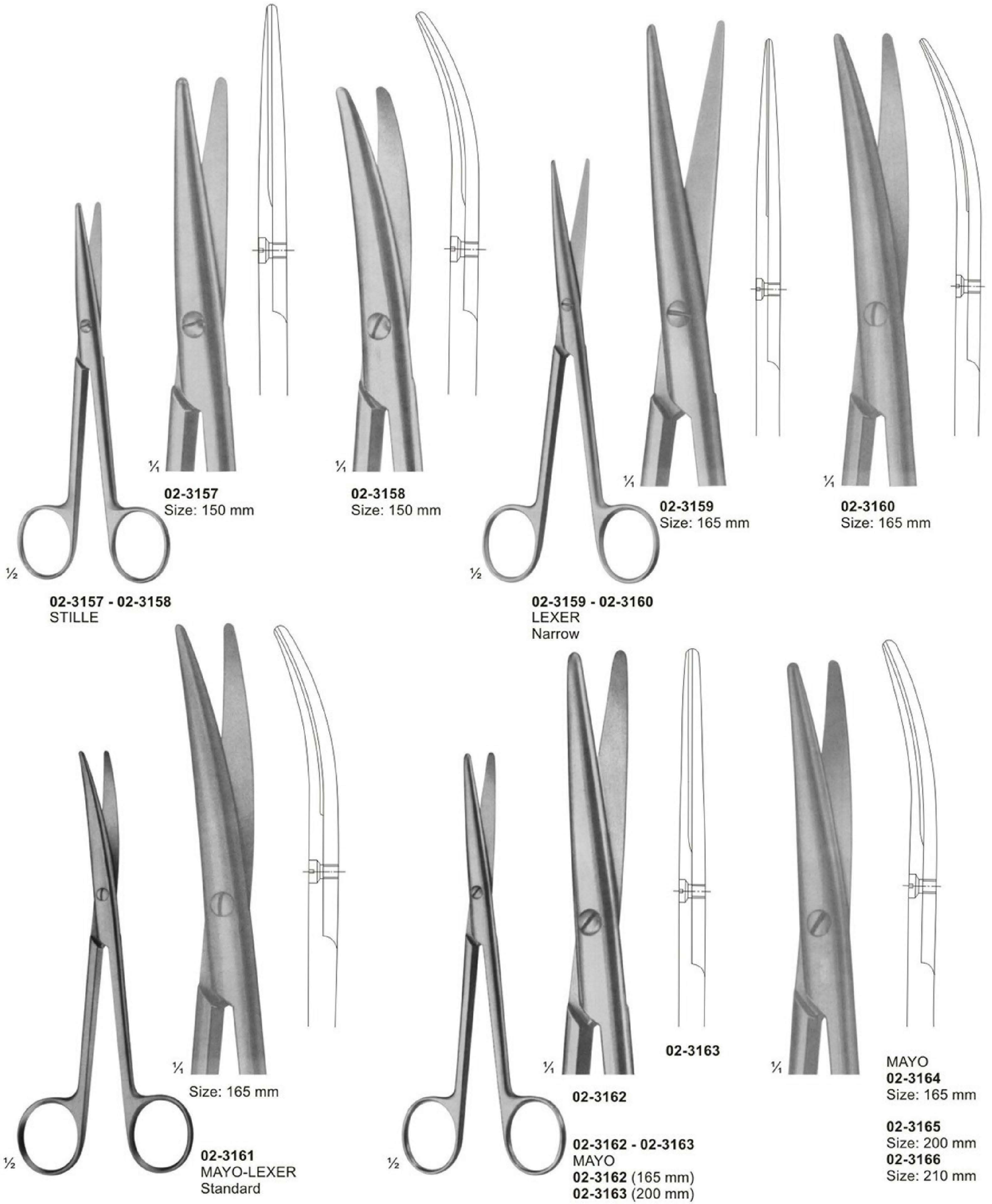

02-3157
Size: 150 mm

02-3158
Size: 150 mm

02-3159
Size: 165 mm

02-3160
Size: 165 mm

02-3157 - 02-3158
STILLE

02-3159 - 02-3160
LEXER
Narrow

Size: 165 mm

02-3161
MAYO-LEXER
Standard

02-3162

02-3162 - 02-3163
MAYO
02-3162 (165 mm)
02-3163 (200 mm)

02-3163

MAYO
02-3164
Size: 165 mm

02-3165
Size: 200 mm
02-3166
Size: 210 mm

Dissecting Scissors

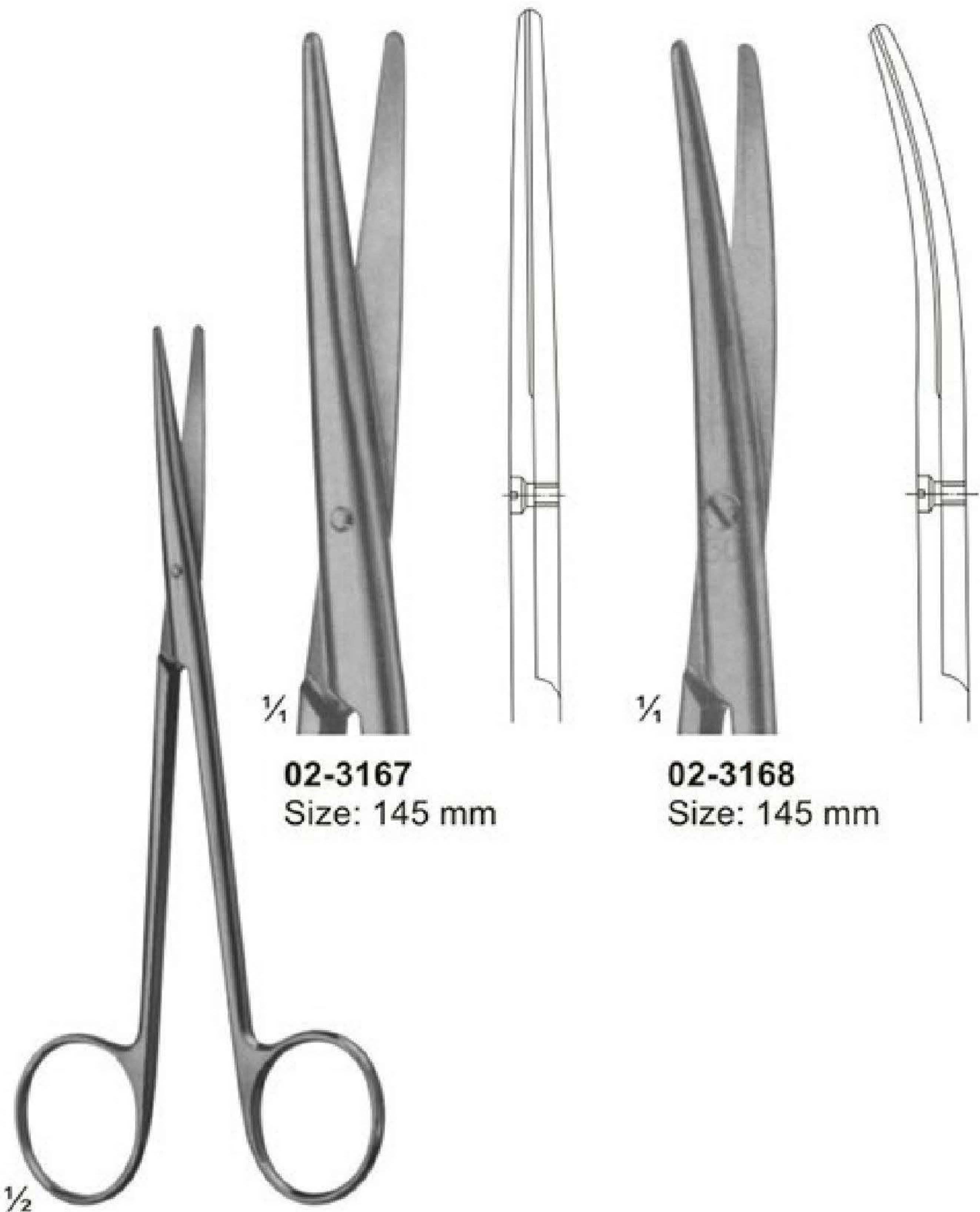

02-3167
 Size: 145 mm

02-3168
 Size: 145 mm

02-3167 - 02-3168
 BABY - METZENBAUM

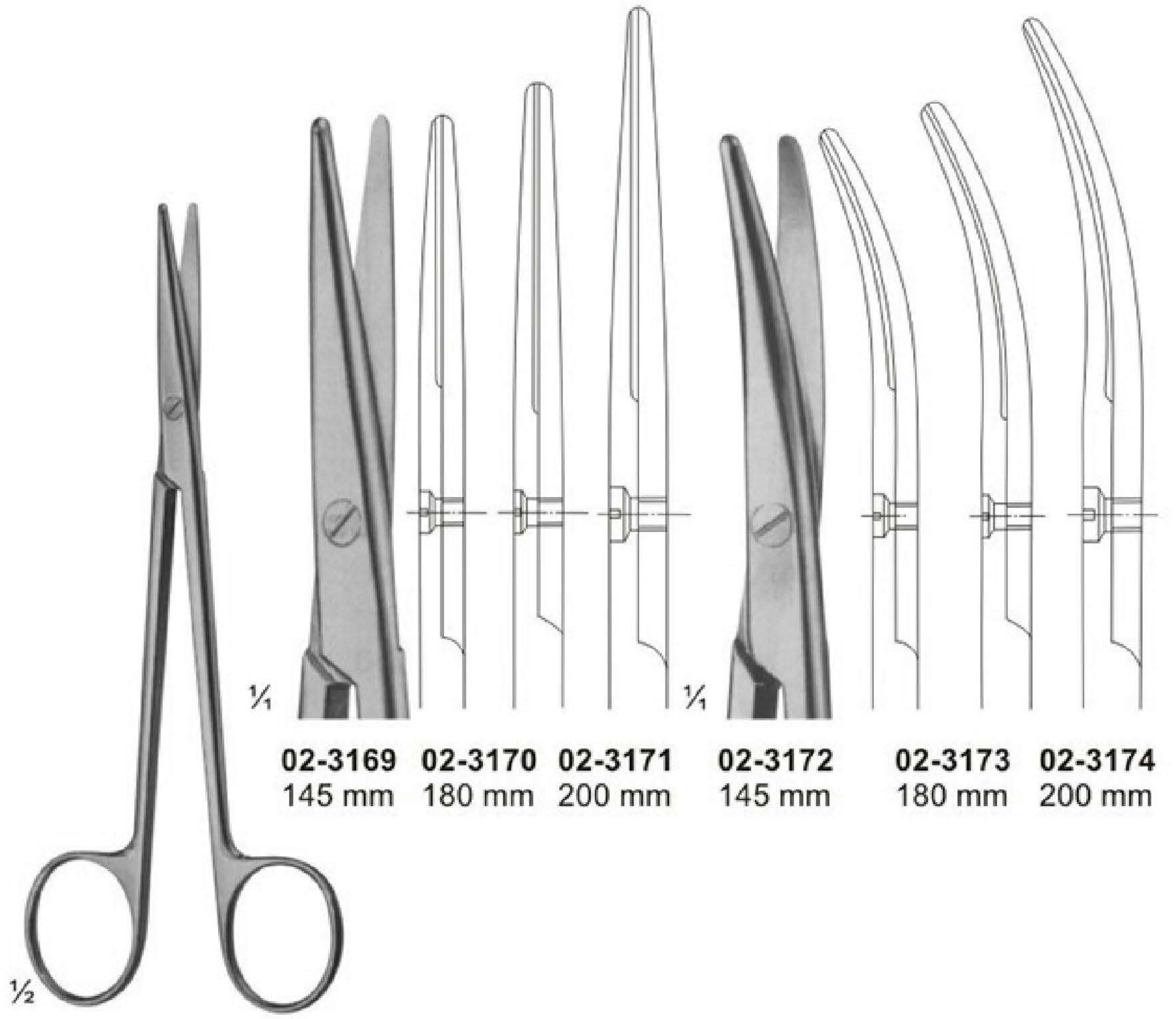

02-3169
 145 mm

02-3170
 180 mm

02-3171
 200 mm

02-3172
 145 mm

02-3173
 180 mm

02-3174
 200 mm

02-3169 - 02-3174
 METZENBAUM



02-3175 - 02-3182
 NELSON
 METZENBAUM

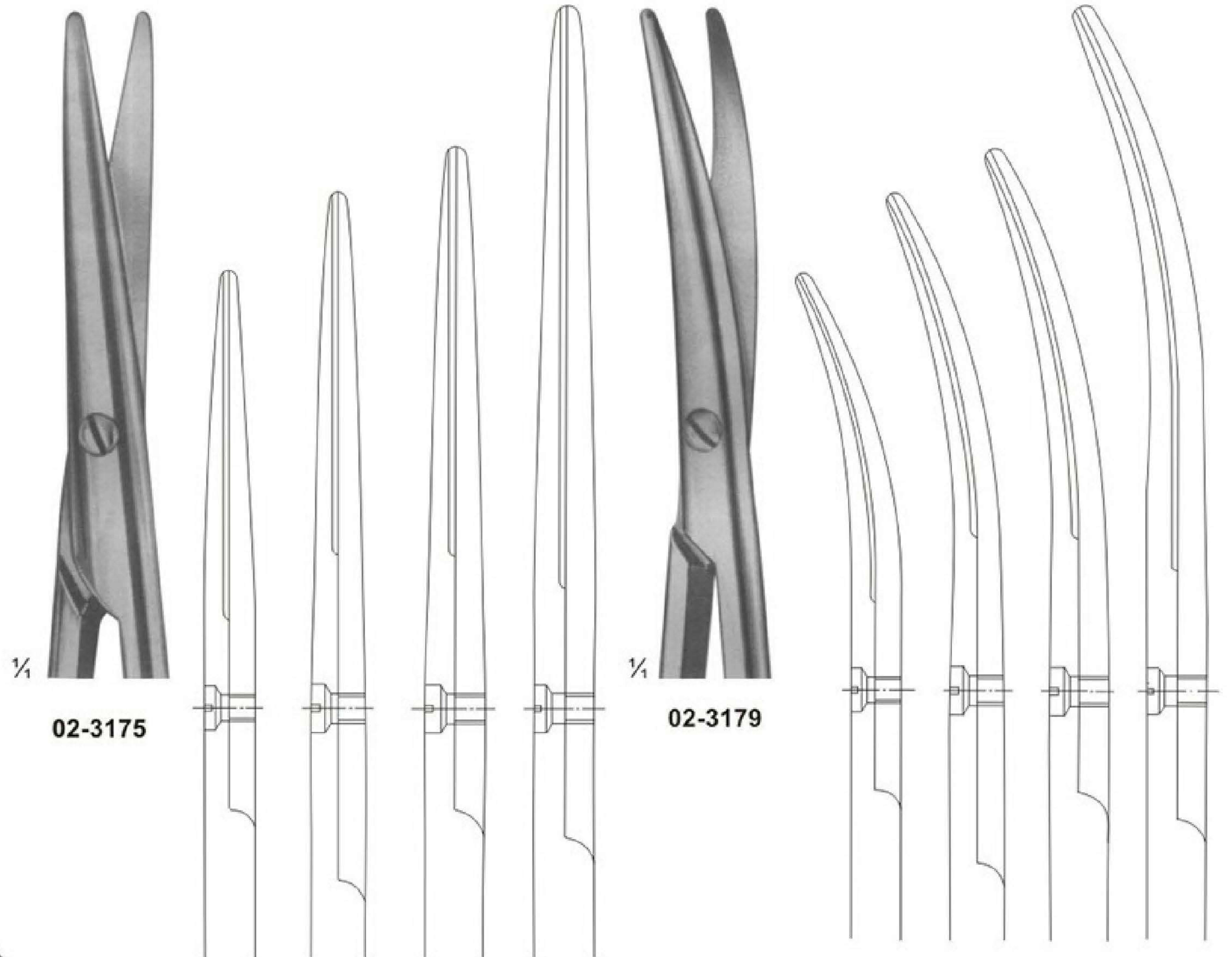

02-3175

02-3179

02-3175
 230 mm

02-3176
 250 mm

02-3177
 280 mm

02-3178
 305 mm

02-3179
 230 mm

02-3180
 250 mm

02-3181
 280 mm

02-3182
 305 mm

Vessel Scissors

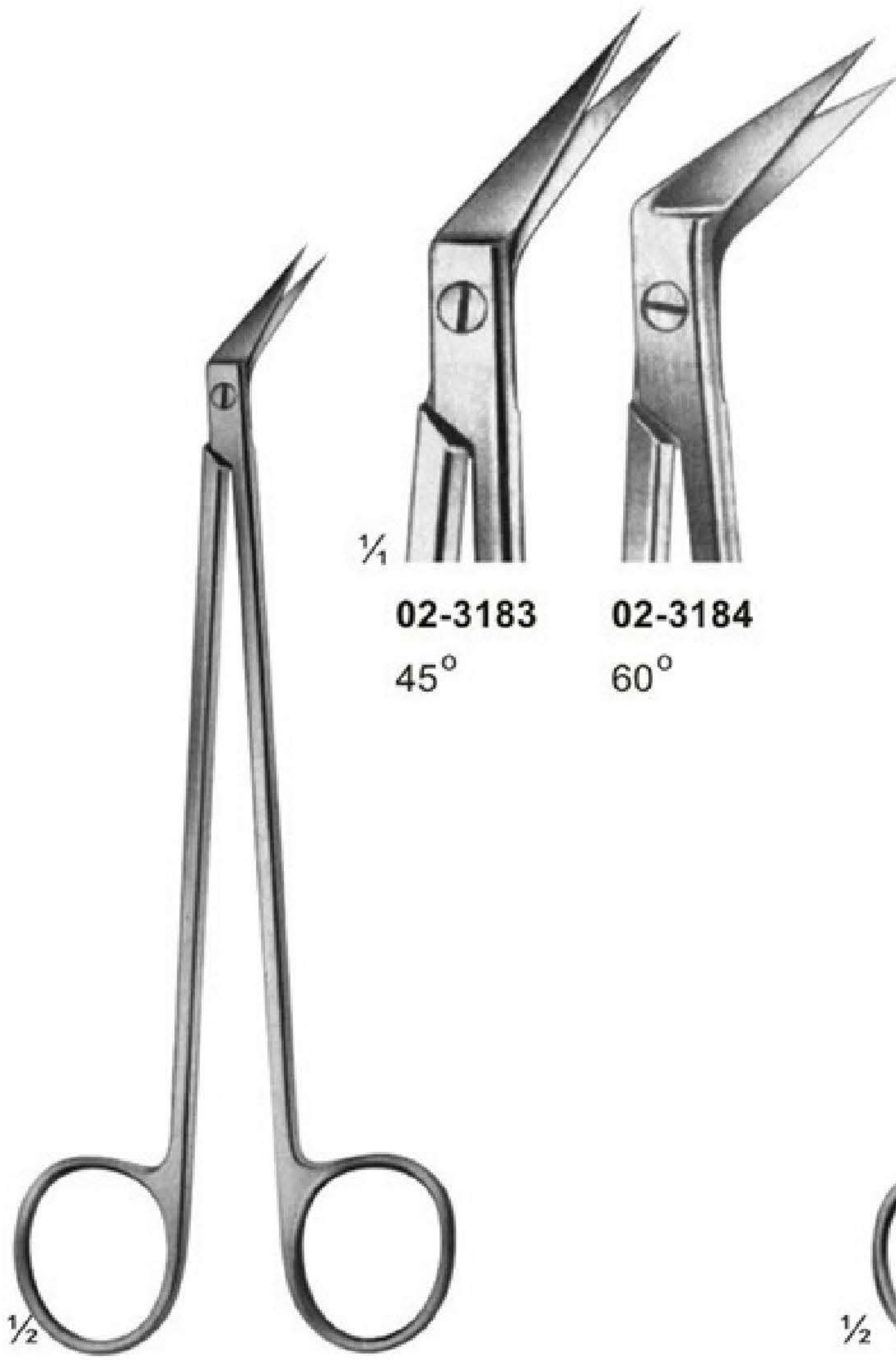

02-3183
45°

02-3184
60°

02-3183 - 02-3184
 DE BAKEY
 Size: 155 mm

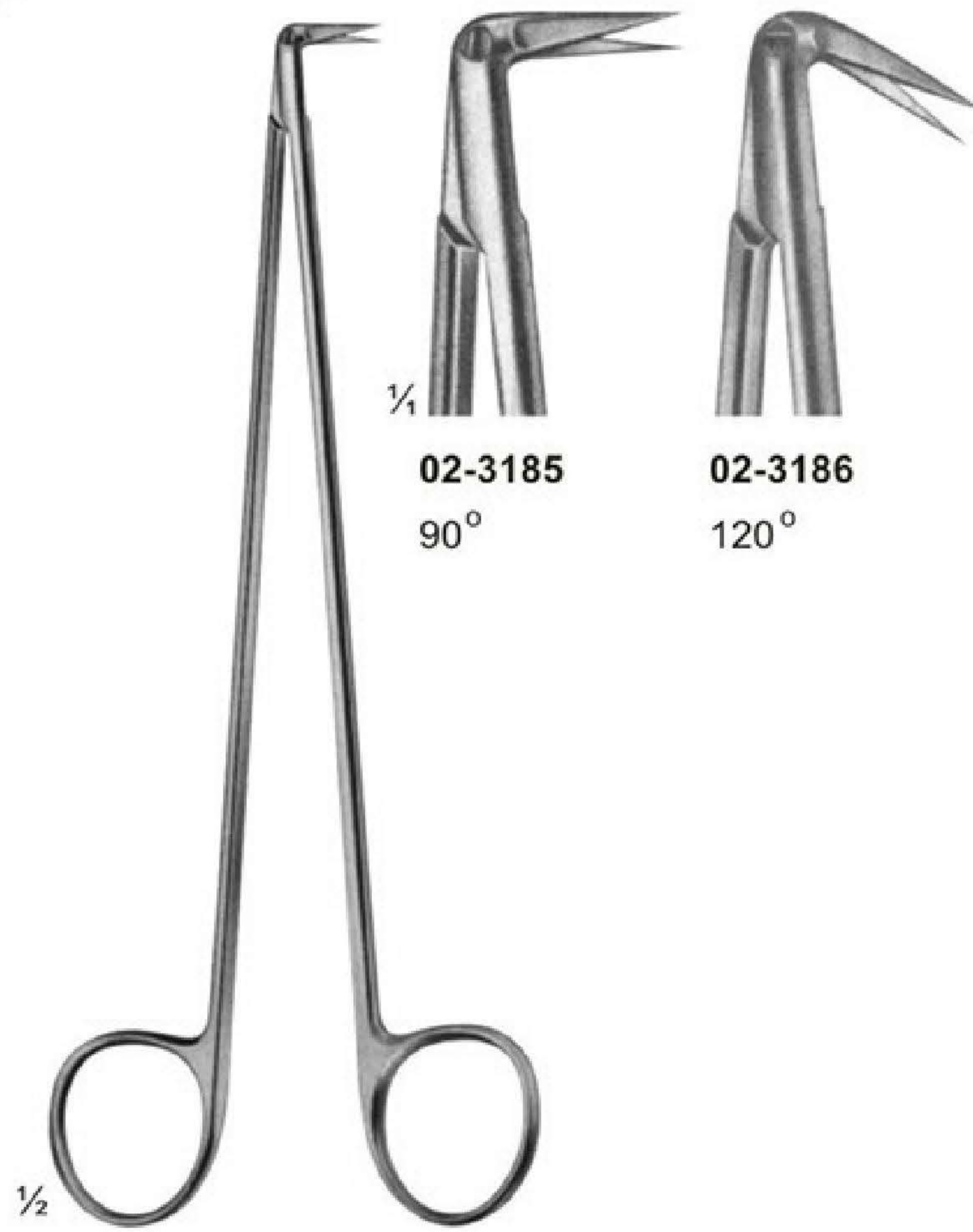

02-3185
90°

02-3186
120°

02-3185 - 02-3186
 DIETRICH
 Size: 170 mm

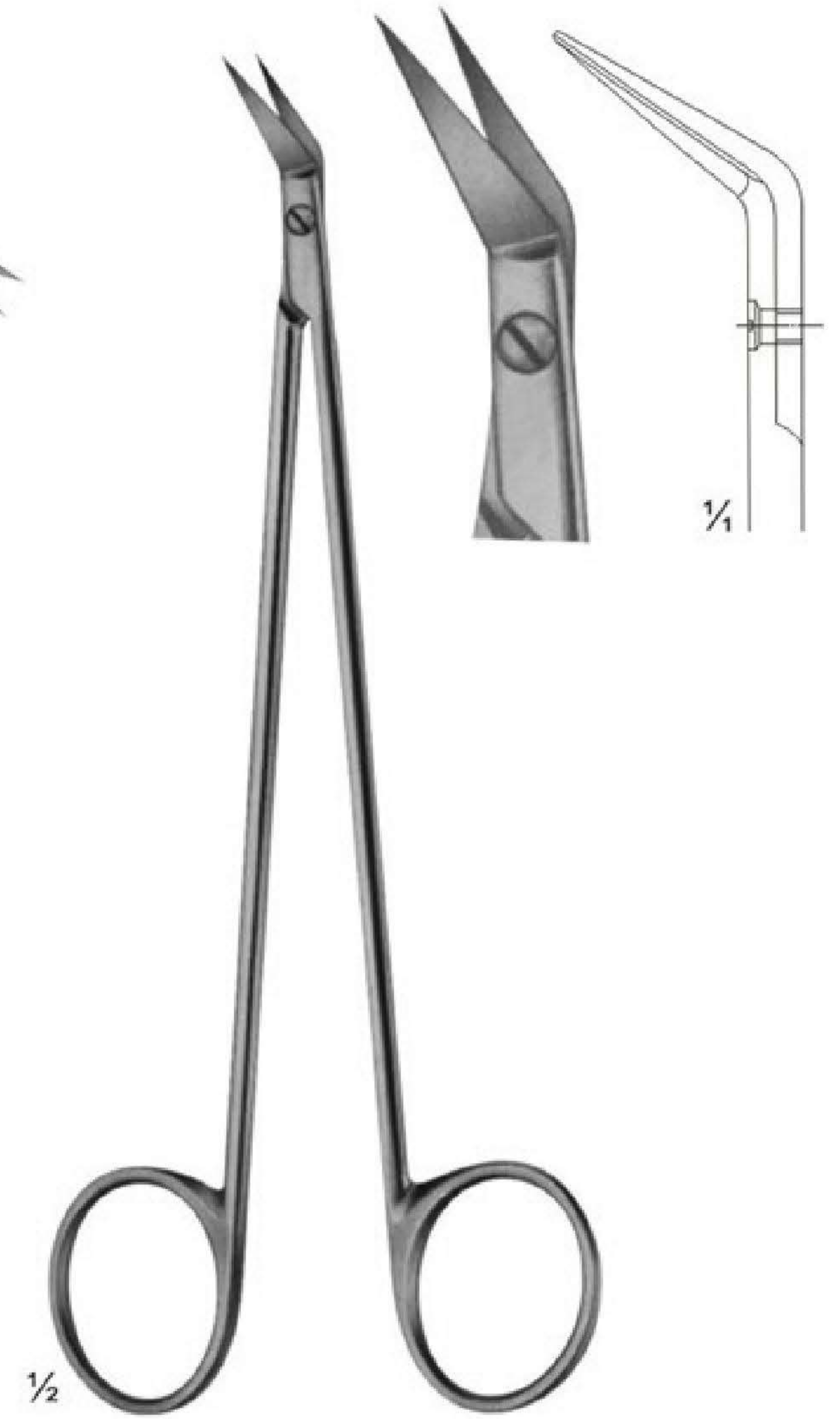

02-3187
 POTTS-SMITH
 Size: 180 mm
 55° Angled on Flat

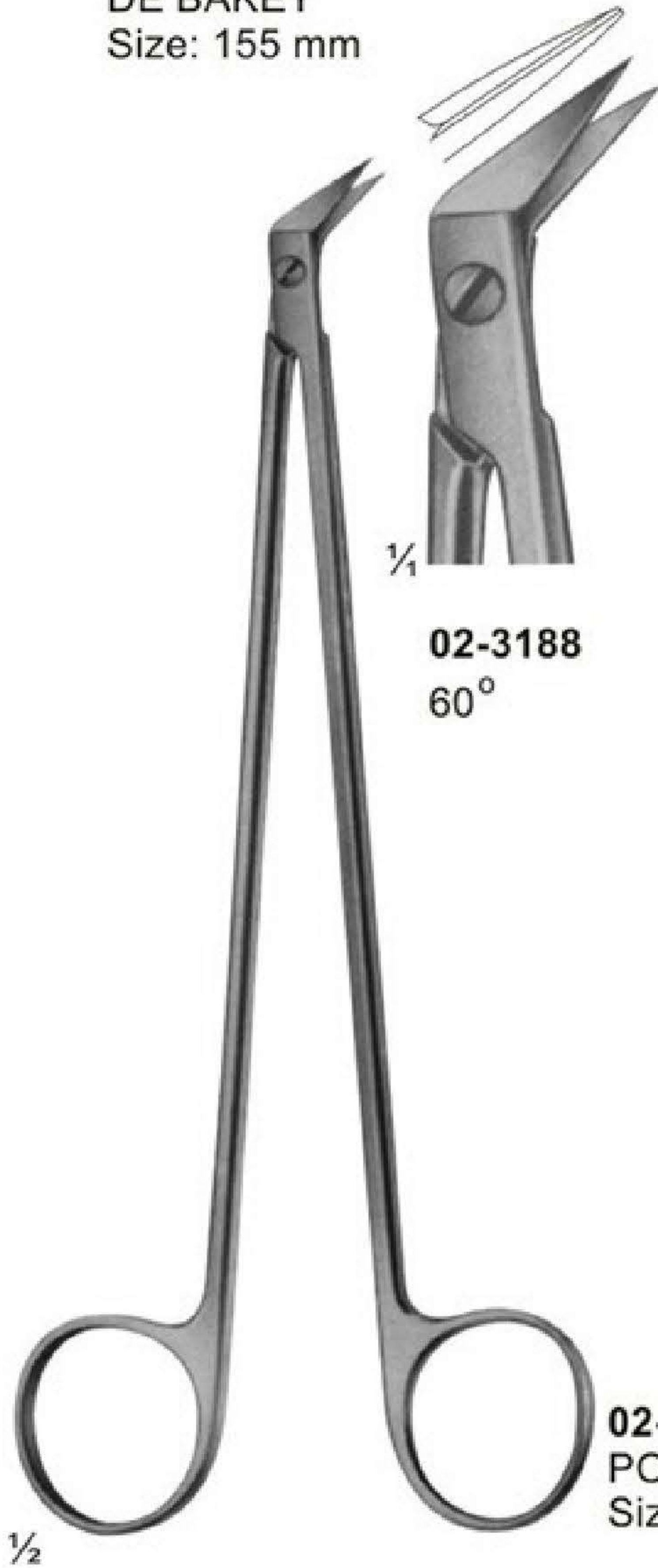

02-3188
60°

02-3188
 POTTS-SMITH
 Size: 180 mm

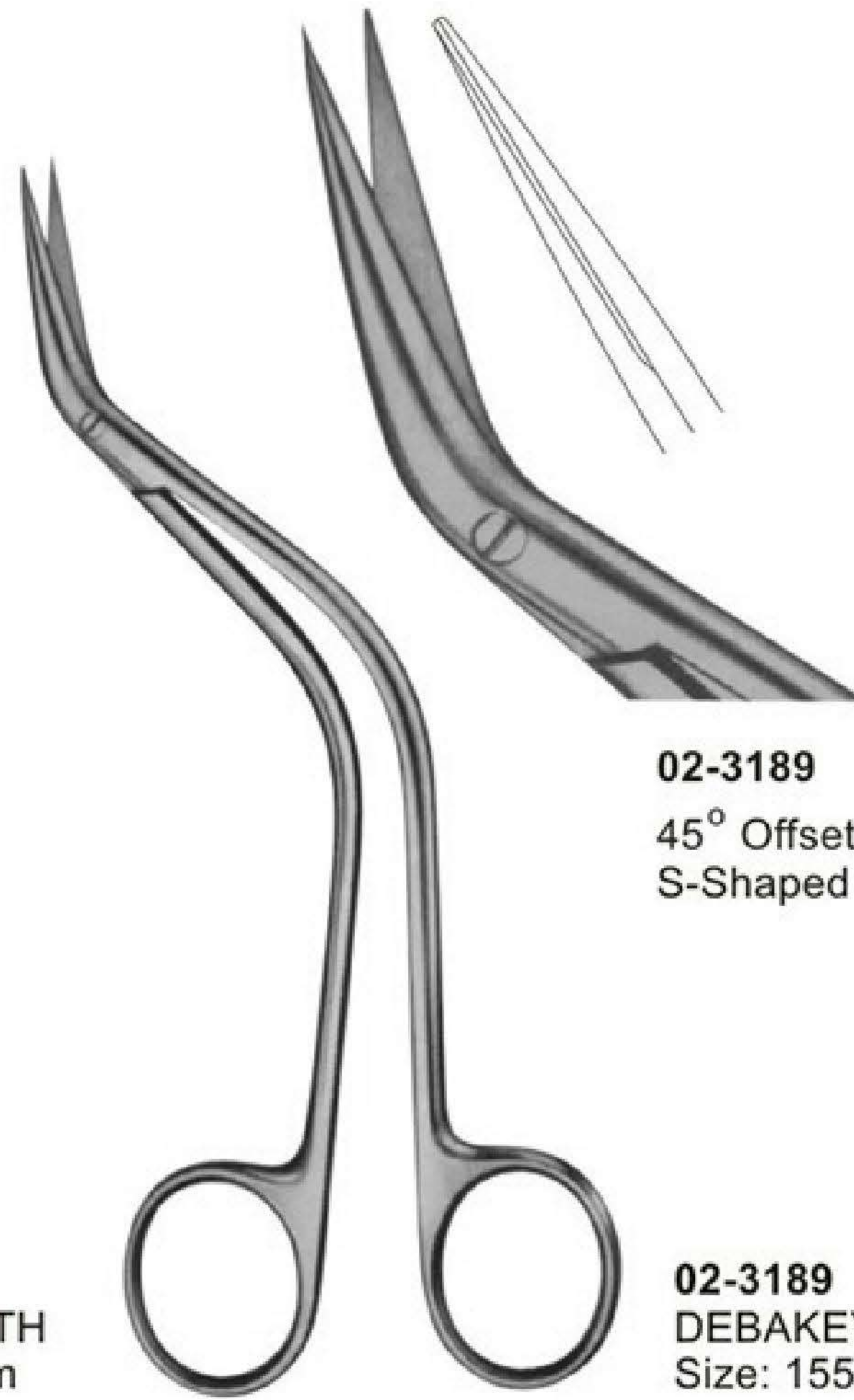

02-3189
 45° Offset Scissors
 S-Shaped

02-3189
 DEBAKEY
 Size: 155 mm



02-3190
55°

02-3190
 FAVOLORO
 Coronary Artery
 Scissors
 Size: 140 mm

Cardiovascular and Neuro-Surgery Scissors

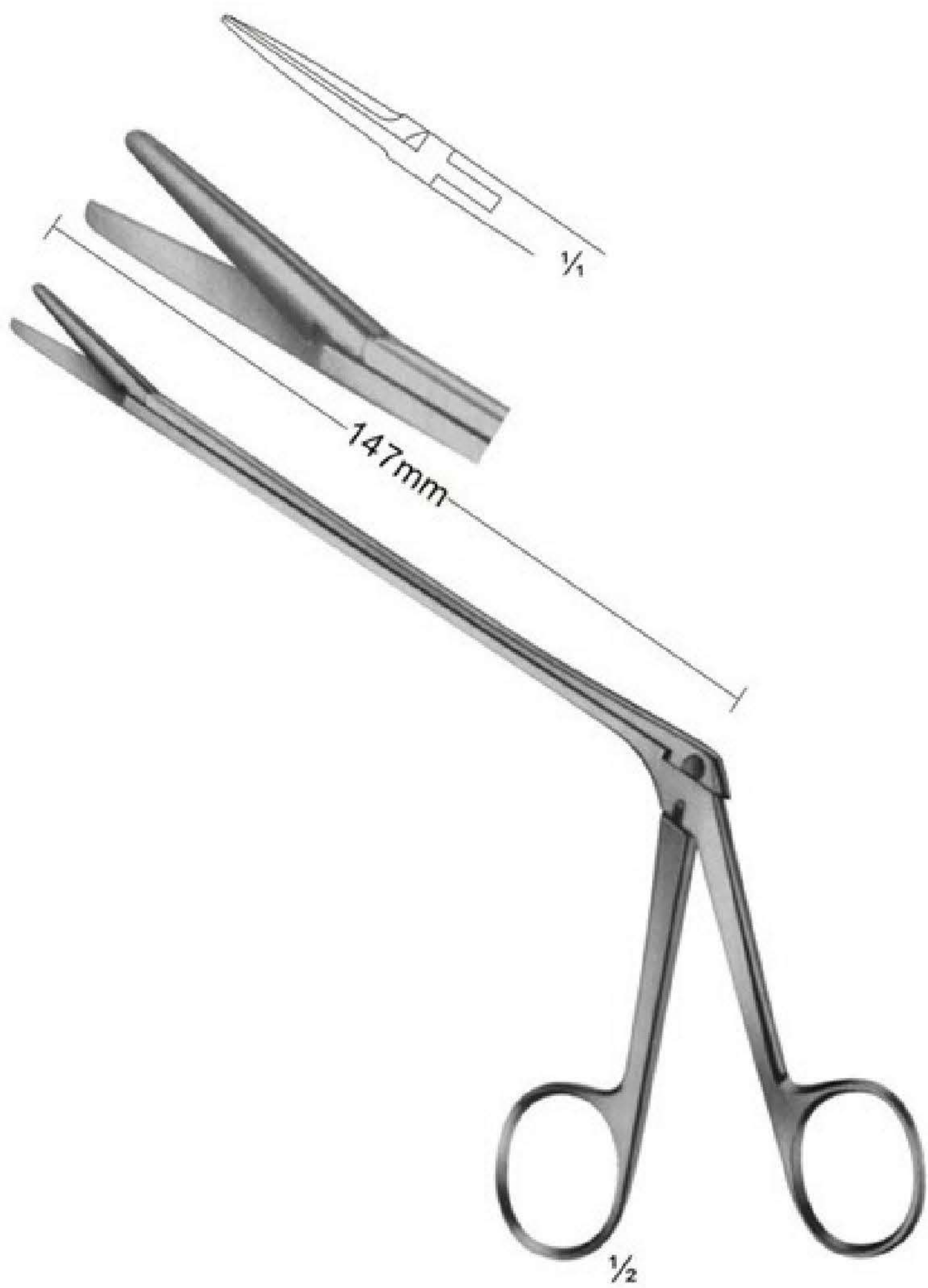

02-3191
 OLIVECRONA
 Dura Scissors

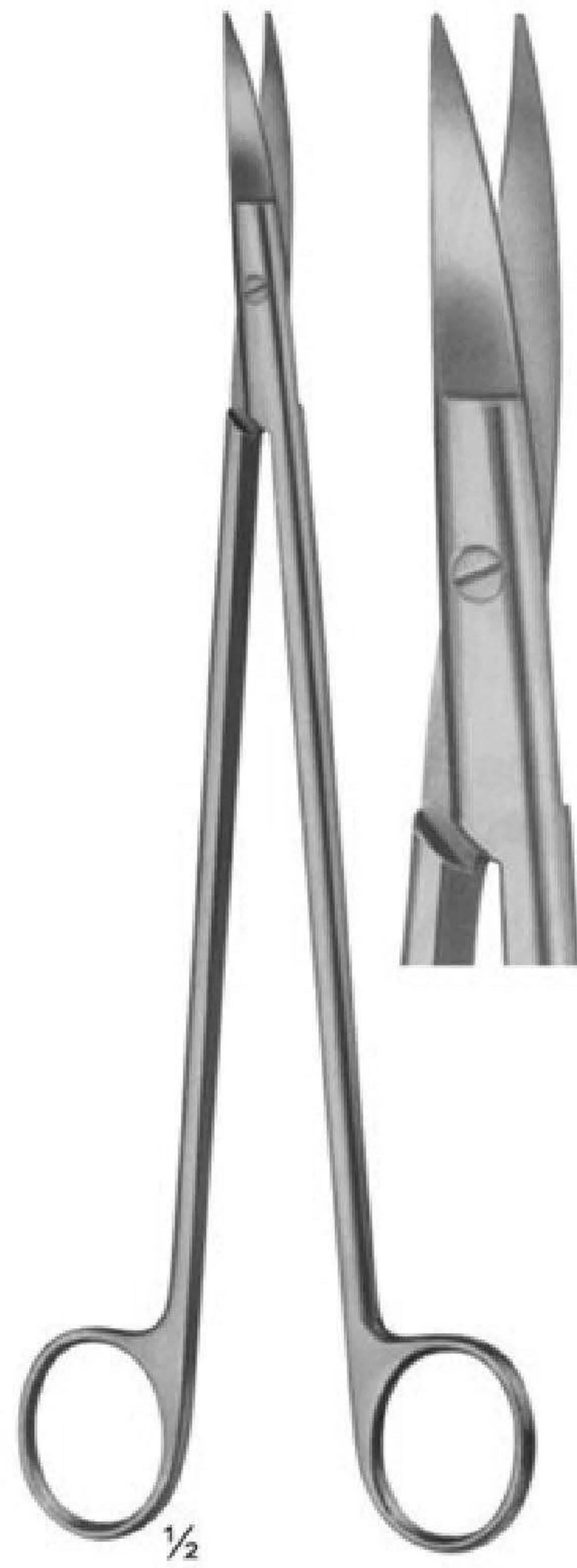

02-3192
 STRULLY
 Pointed
 Size: 220 mm

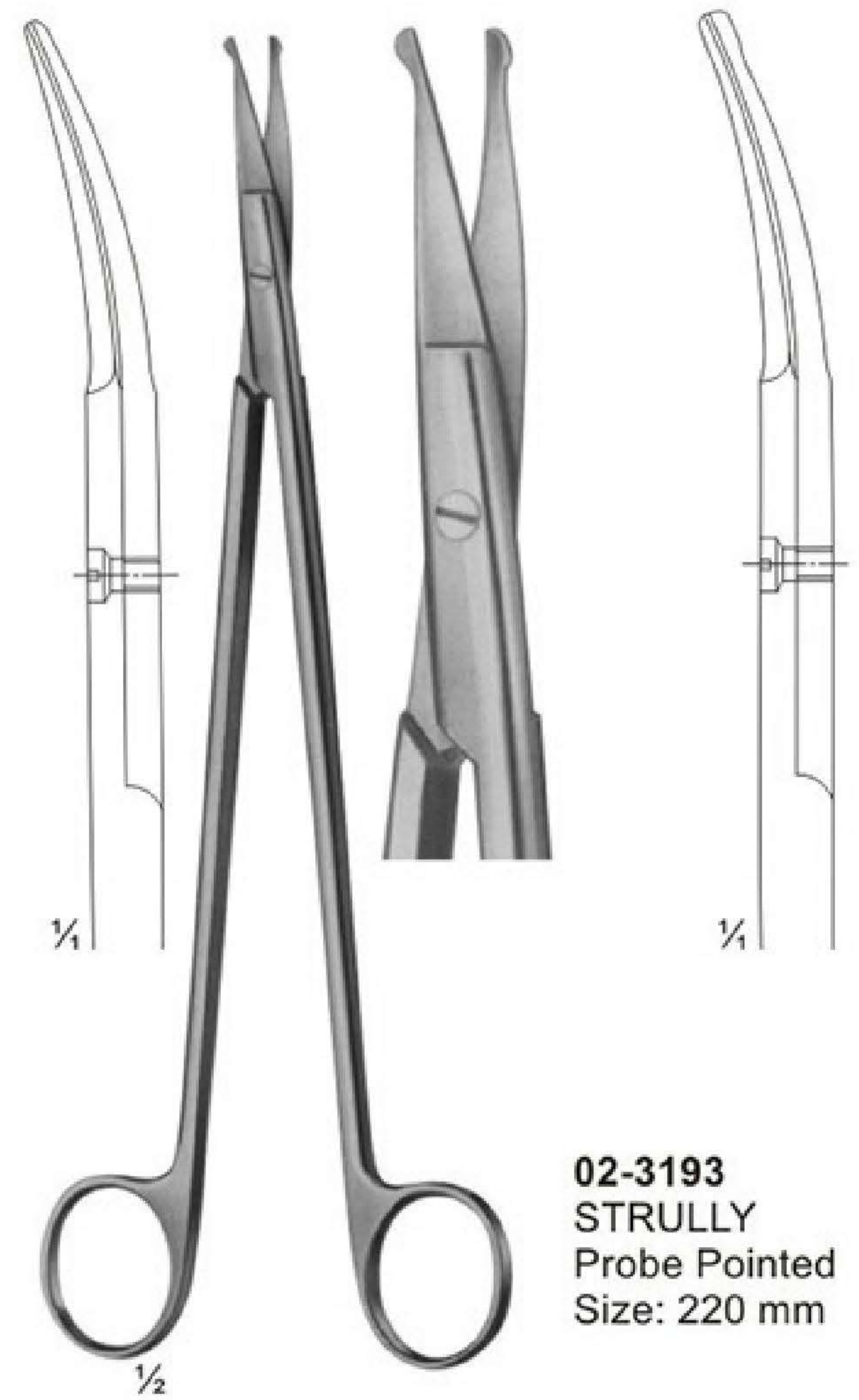

02-3193
 STRULLY
 Probe Pointed
 Size: 220 mm

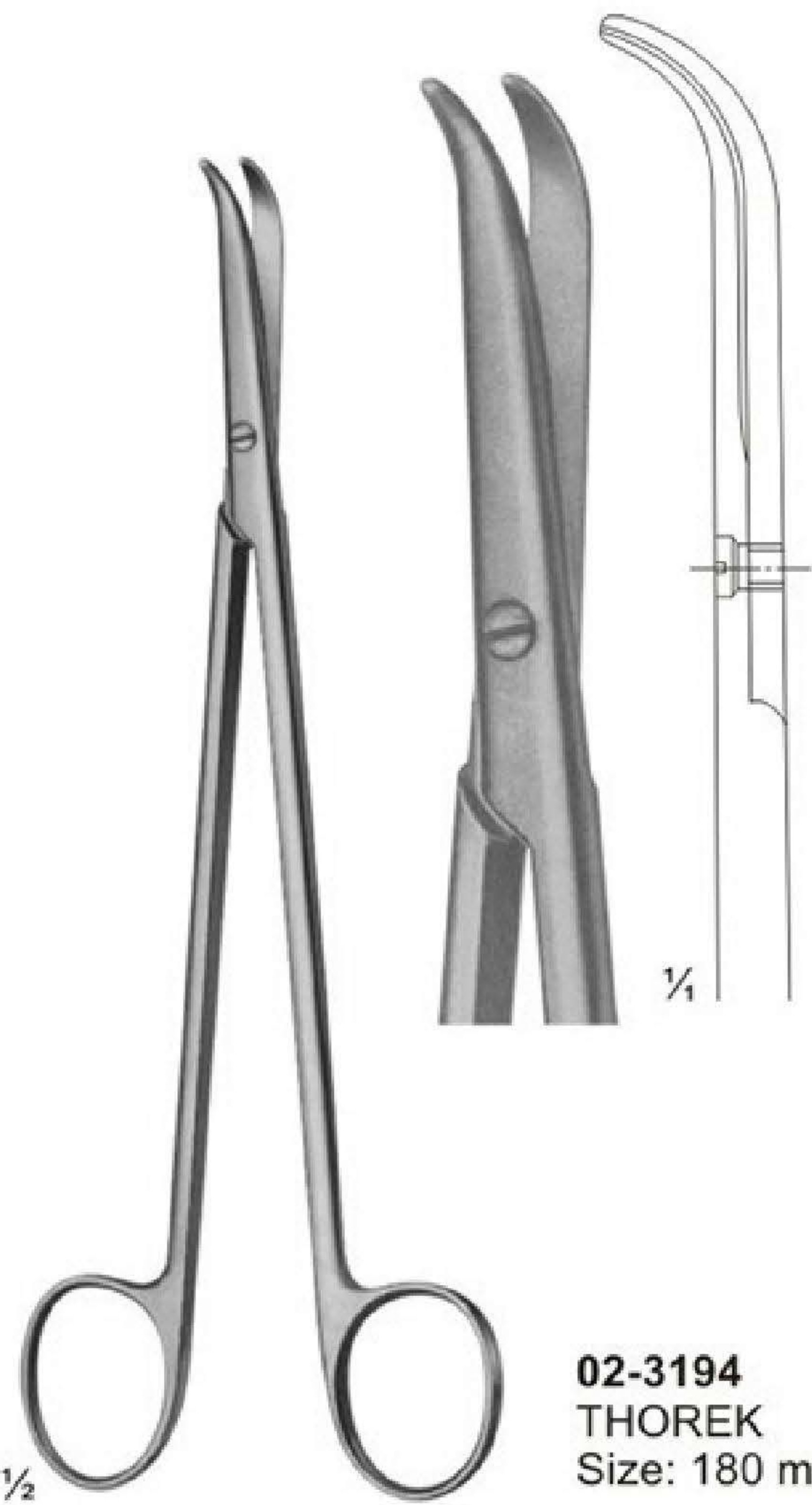

02-3194
 THOREK
 Size: 180 mm

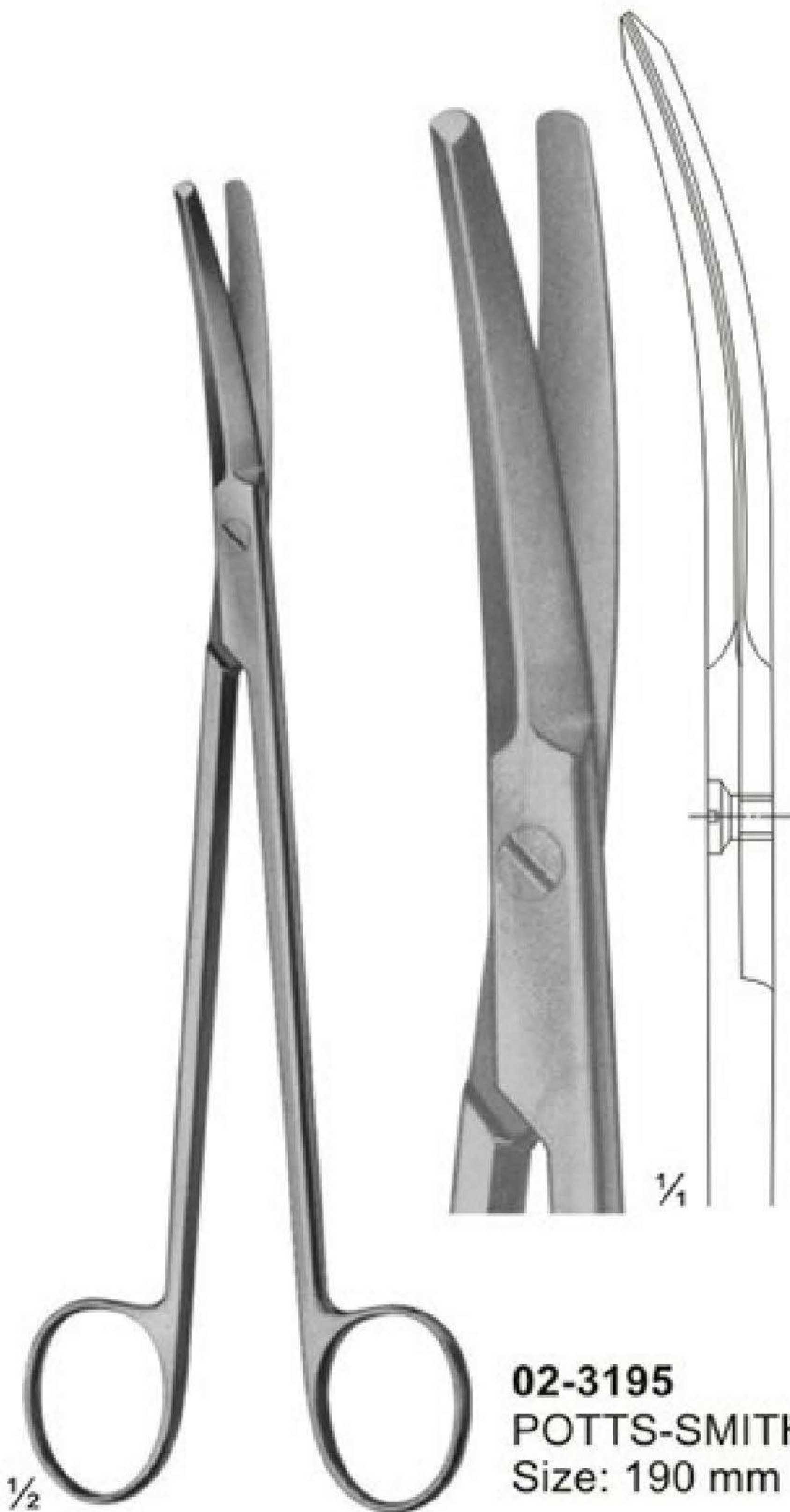

02-3195
 POTTS-SMITH
 Size: 190 mm

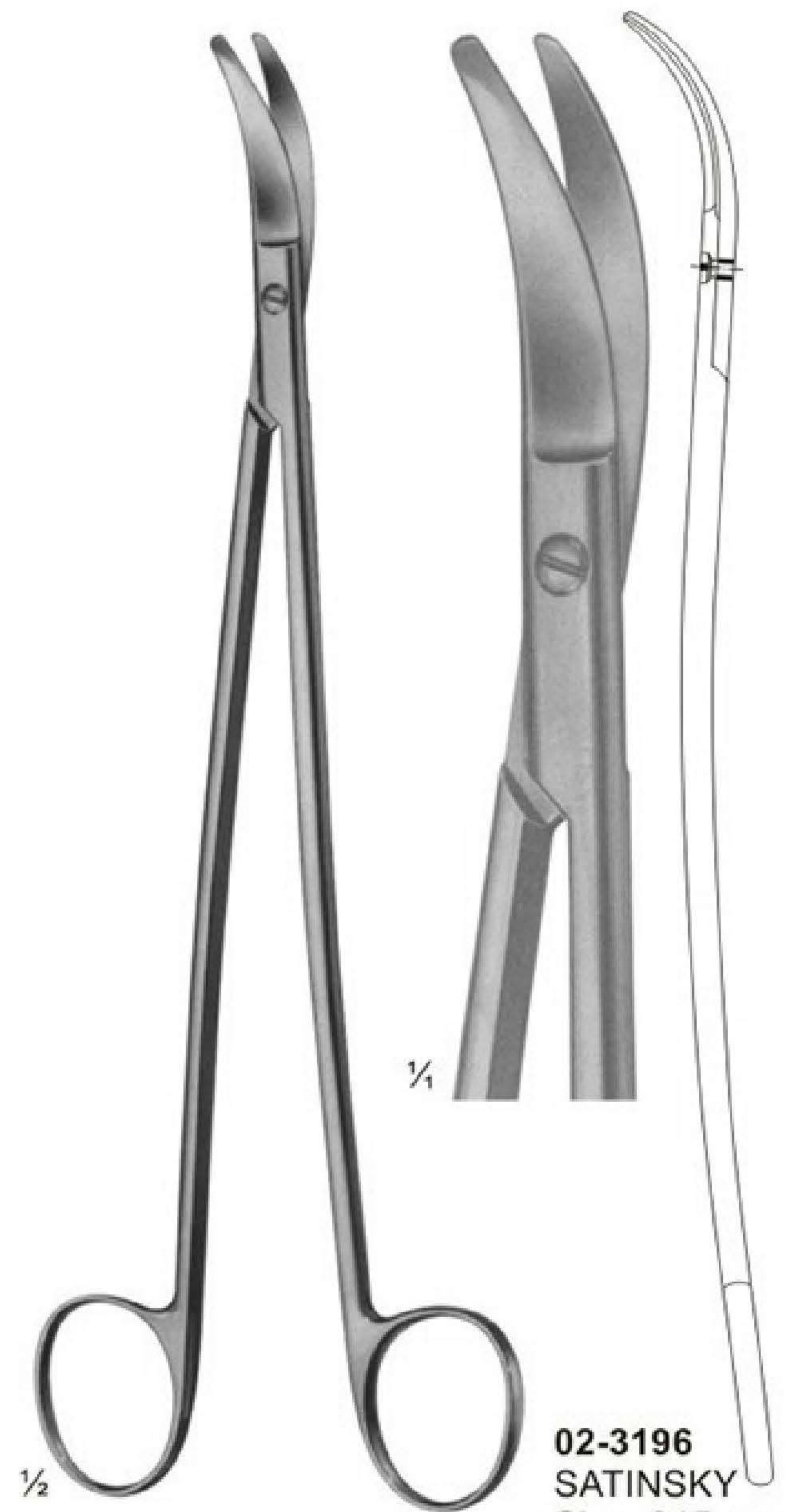

02-3196
 SATINSKY
 Size: 245 mm

Delicate, Nasal and Tonsil Scissors



02-3197
1 Finely Toothed Blade
Size: 130 mm

02-3198
LOCKLIN
Curved Sideways,
1 Toothed Blade
Size: 155 mm

02-3199
FOMON
Blades Serrated
Size: 145 mm

02-3200
COTTLE
Size: 165 mm

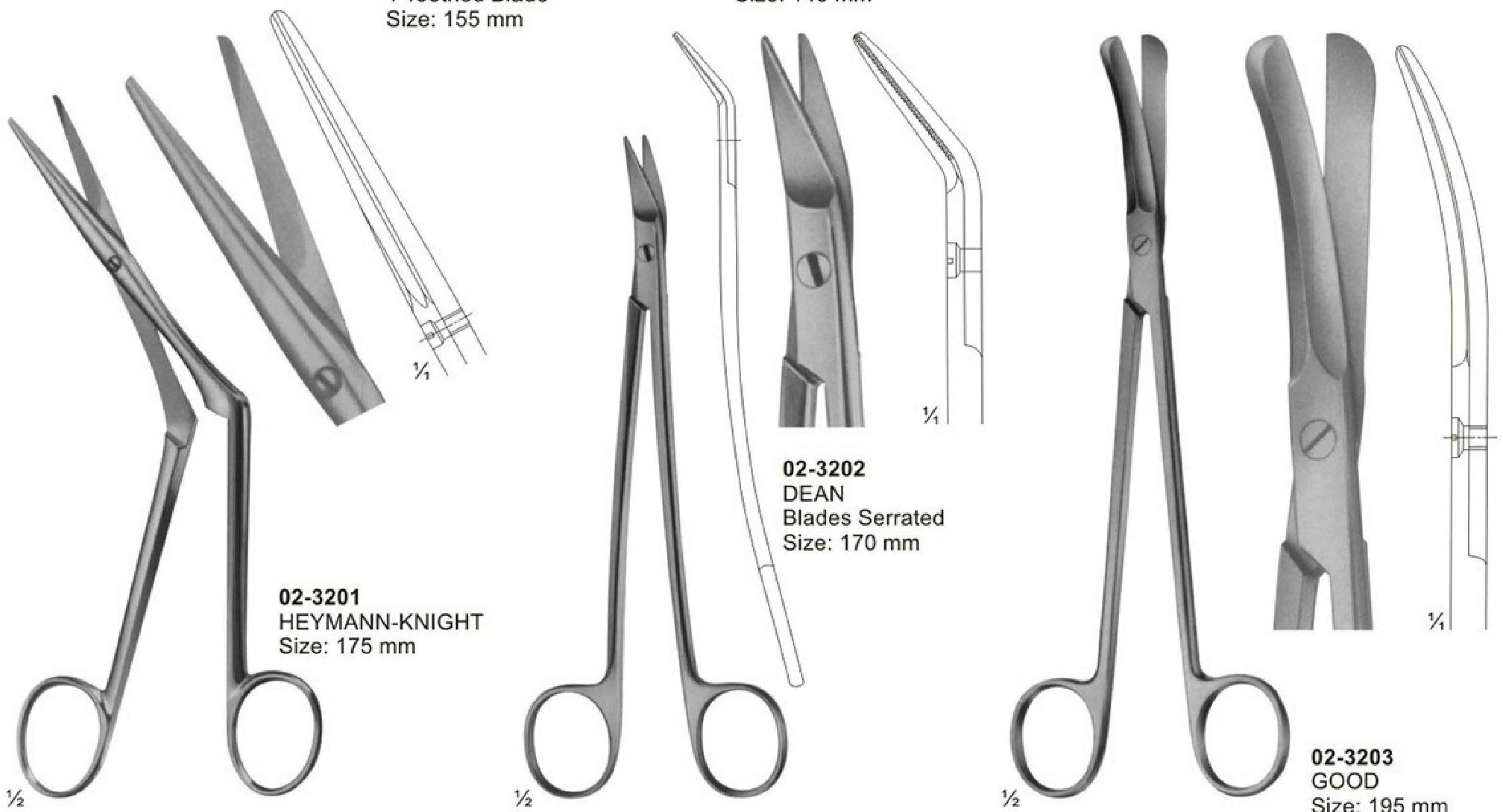

02-3201
HEYMANN-KNIGHT
Size: 175 mm

02-3202
DEAN
Blades Serrated
Size: 170 mm

02-3203
GOOD
Size: 195 mm

Bone Shears



02-3204
 KILLIAN
 Size: 200 mm



02-3205 - 02-3206



02-3205
 195 mm

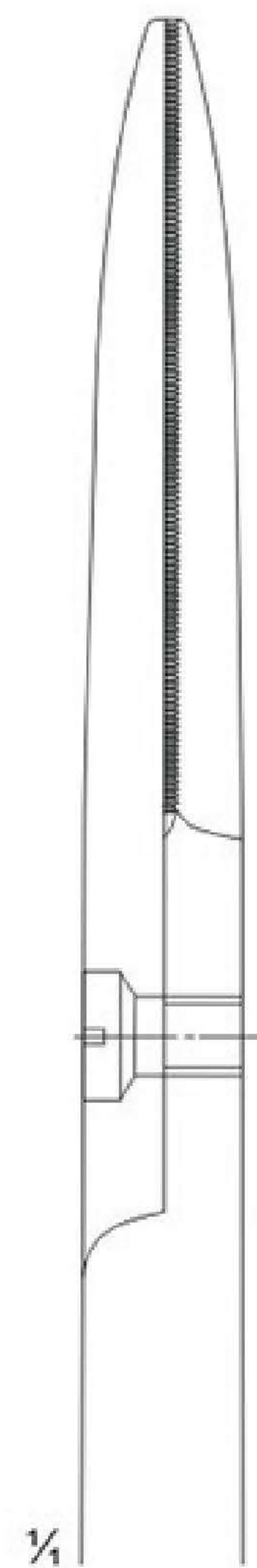

02-3206
 225 mm

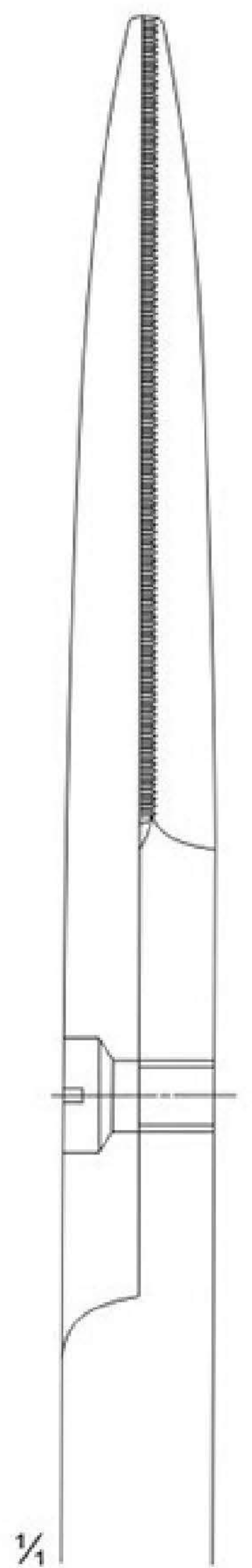

Operating and Gynaecology Scissors

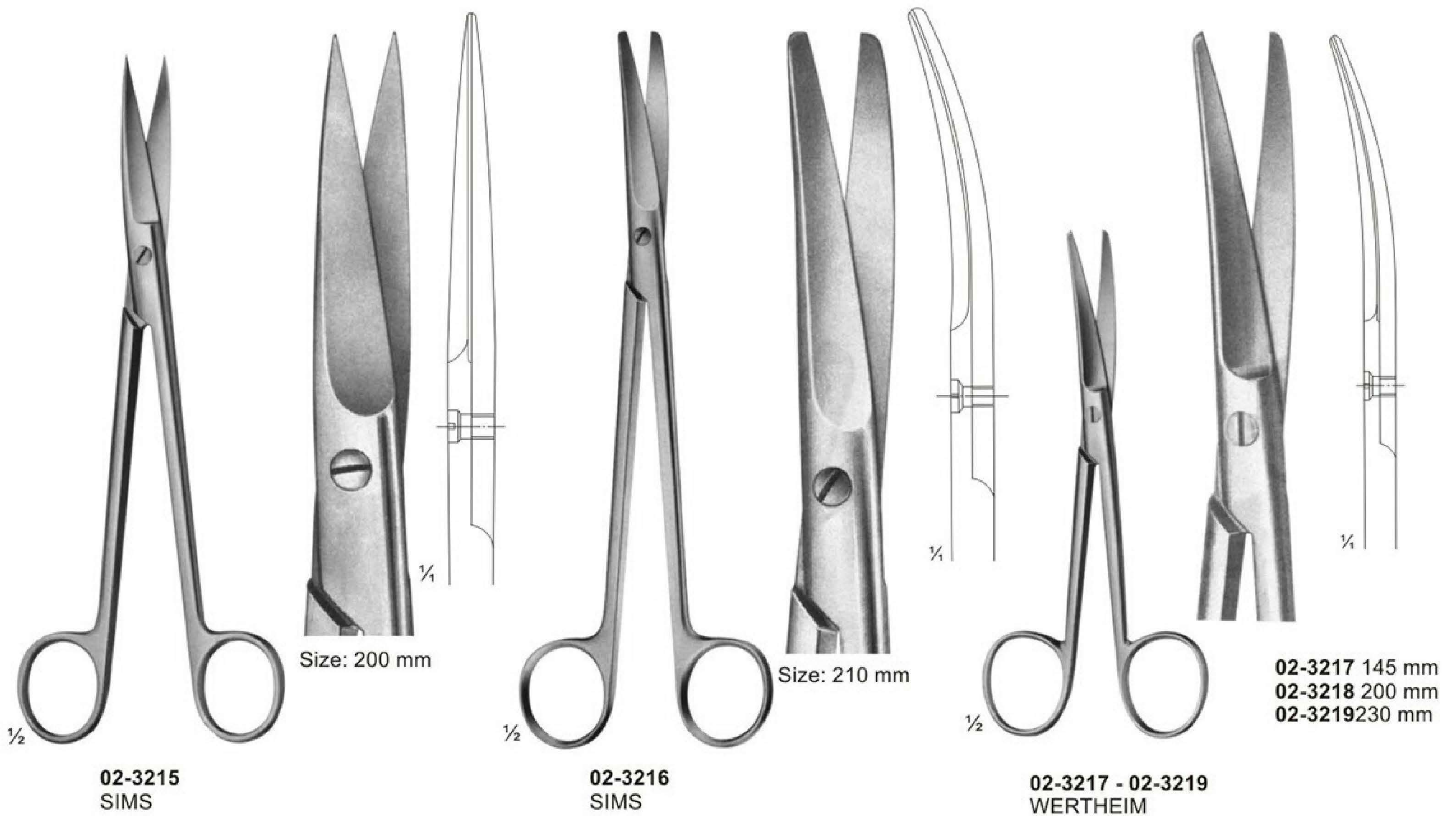
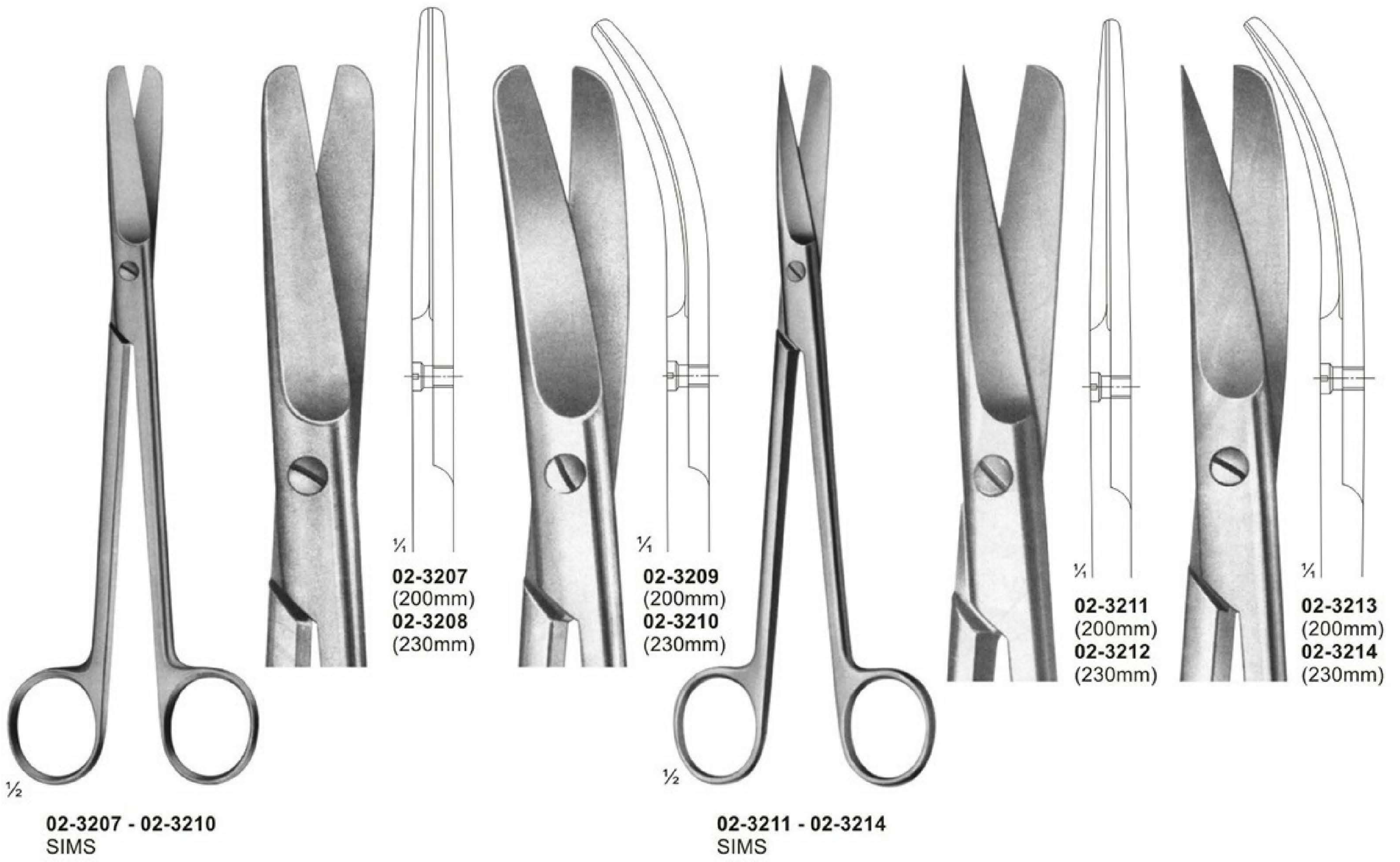

Operating and Gynaecology Scissors

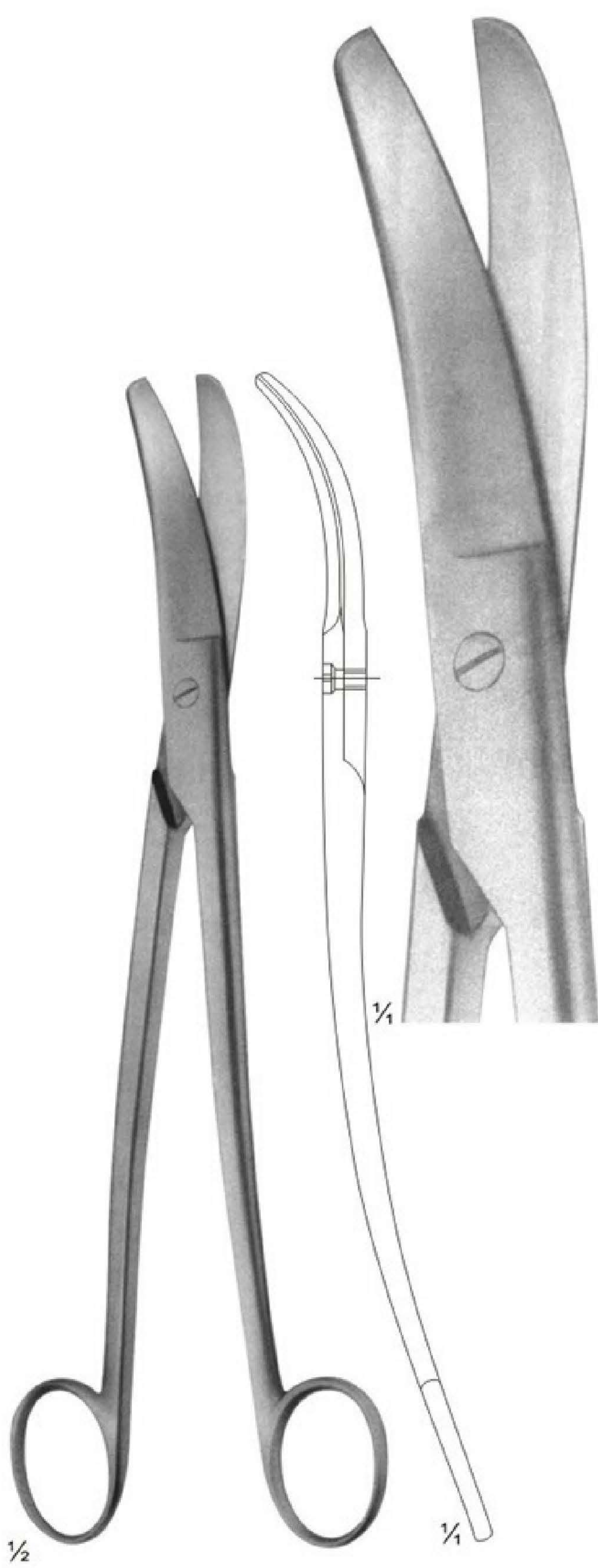

02-3220
 SIEBOLD
 Uterine Scissors
 Size: 245 mm

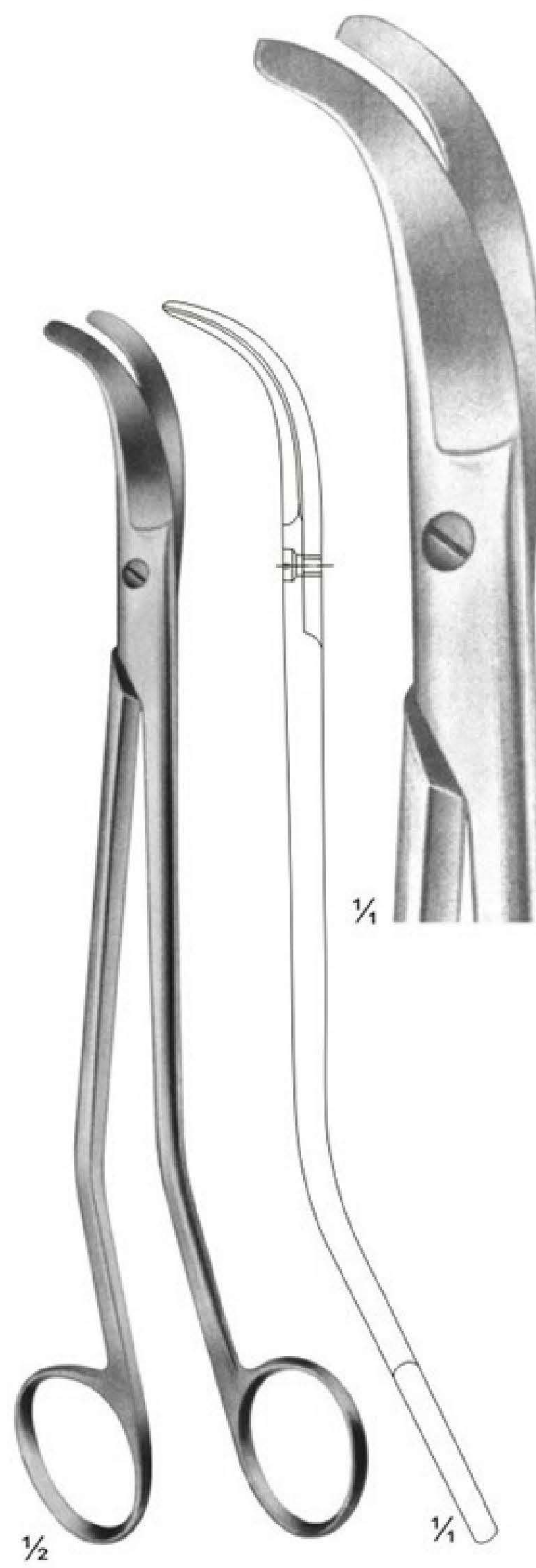

02-3221
 BOZEMANN
 Uterine Scissors
 Size: 220 mm

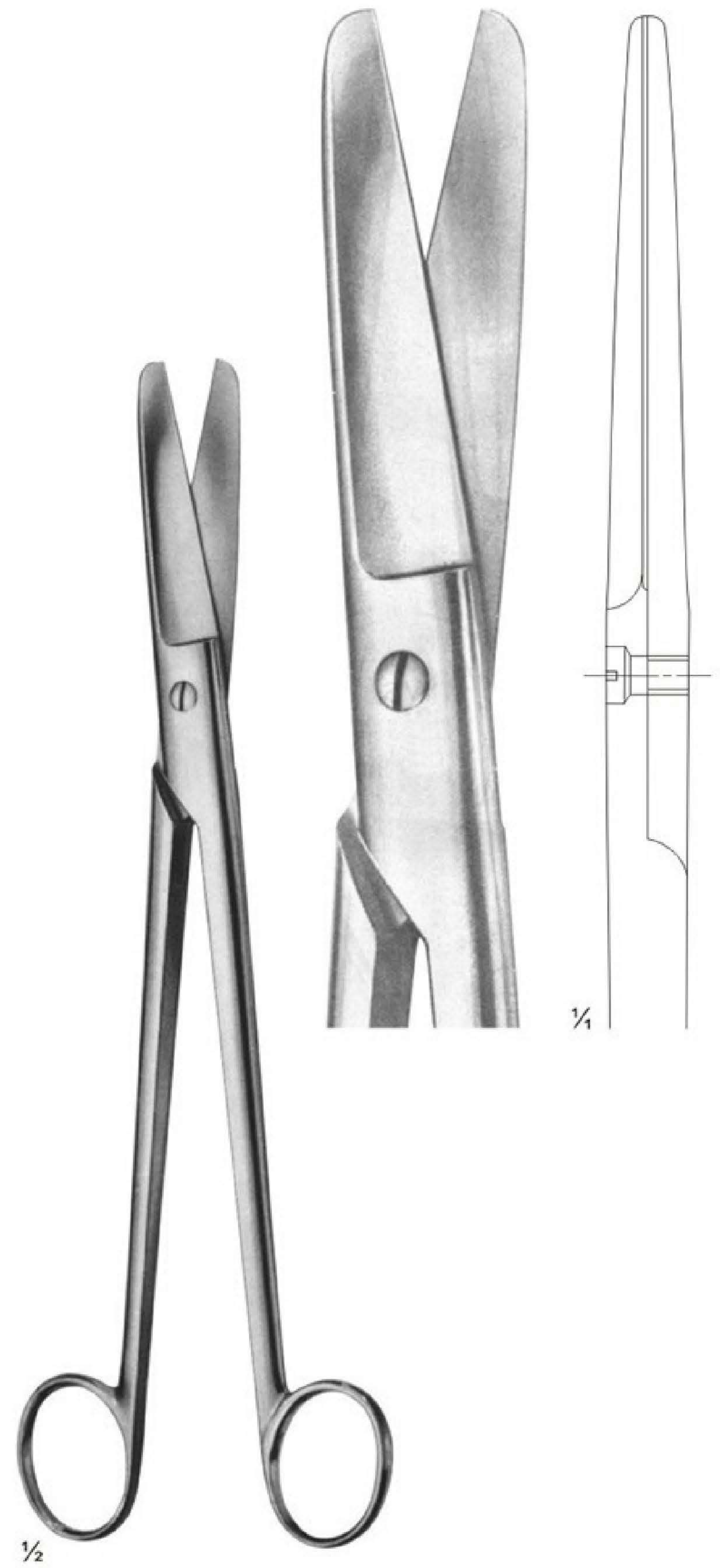

02-3222
 SIMS-SIEBOLD
 Uterine Scissors
 Size: 250 mm

Scissors For Obstetrics



02-3223
 SCHUMACHER
 Umbilical Cord Scissors
 Size: 155 mm



02-3224
 Umbilical Cord Scissors
 Size: 105 mm

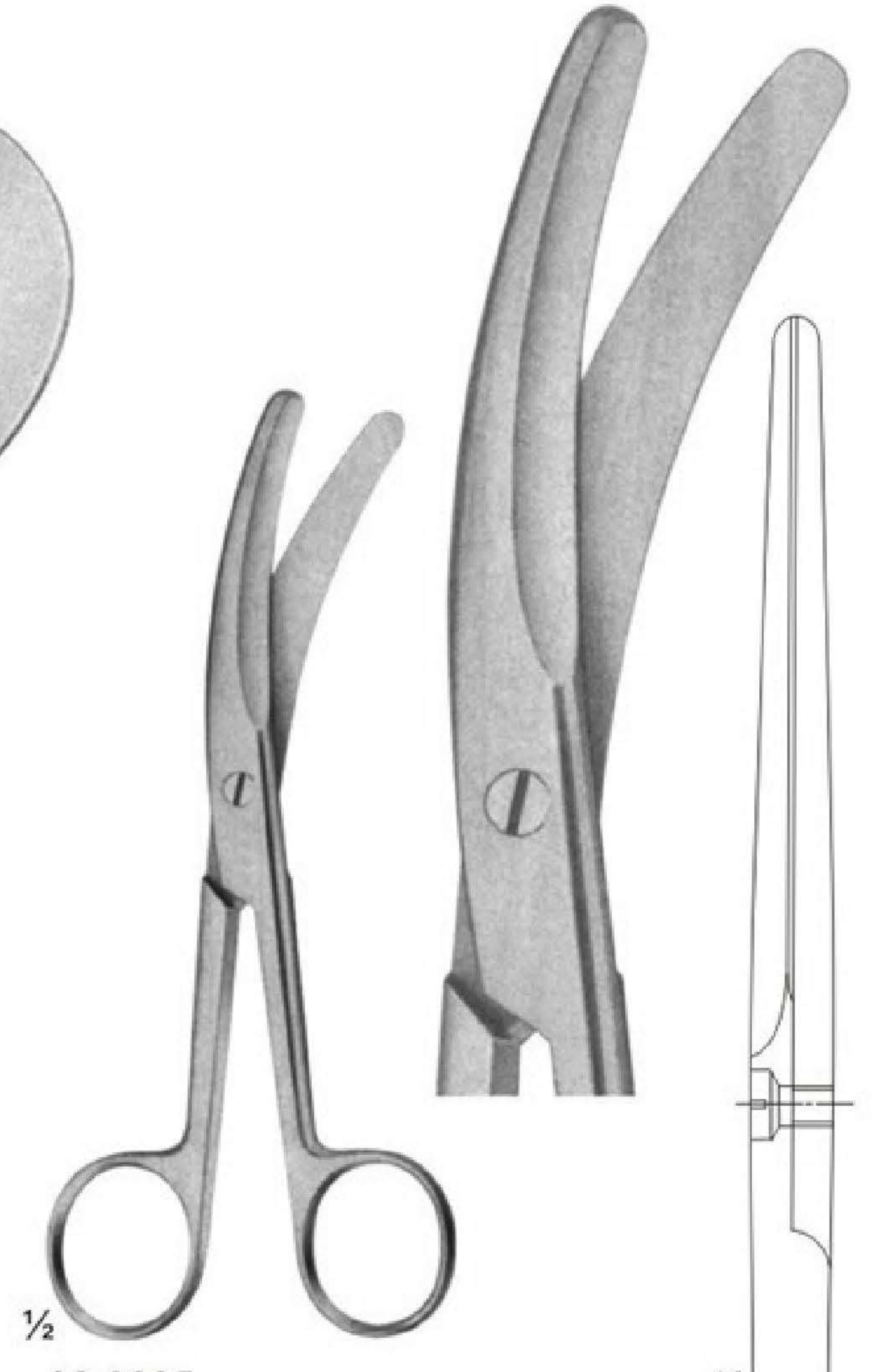

02-3225
 Umbilical Cord Scissors

$\frac{1}{4}$
 135 mm

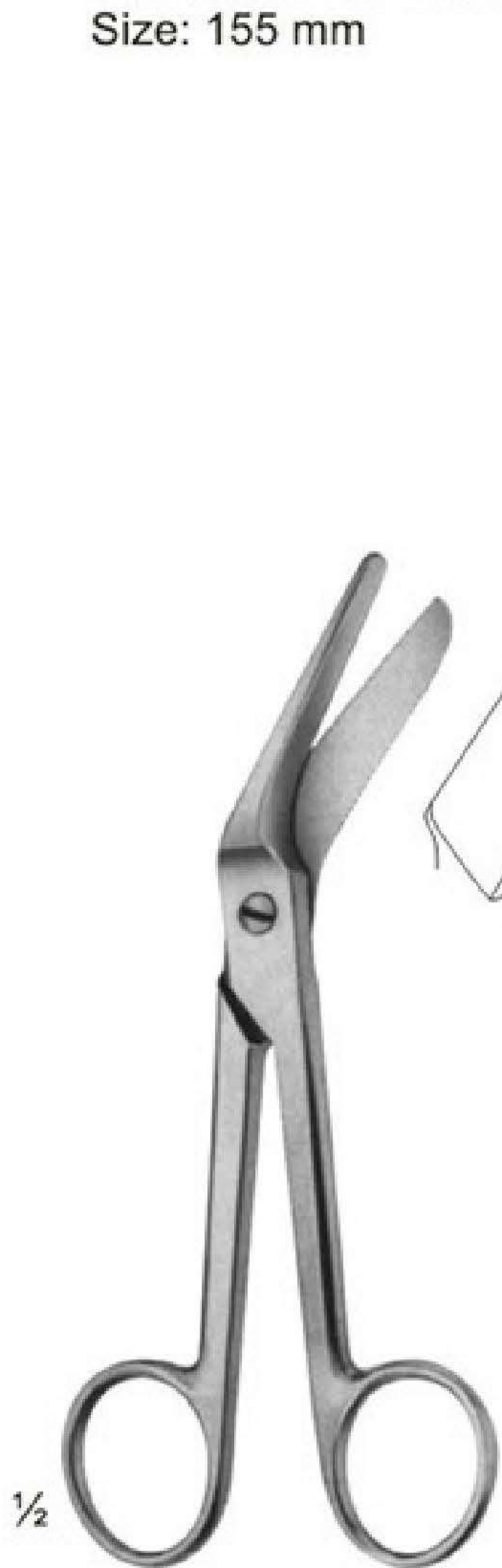

02-3226 - 02-3227
 BRAUN-STADLER
 Episiotomy Scissors

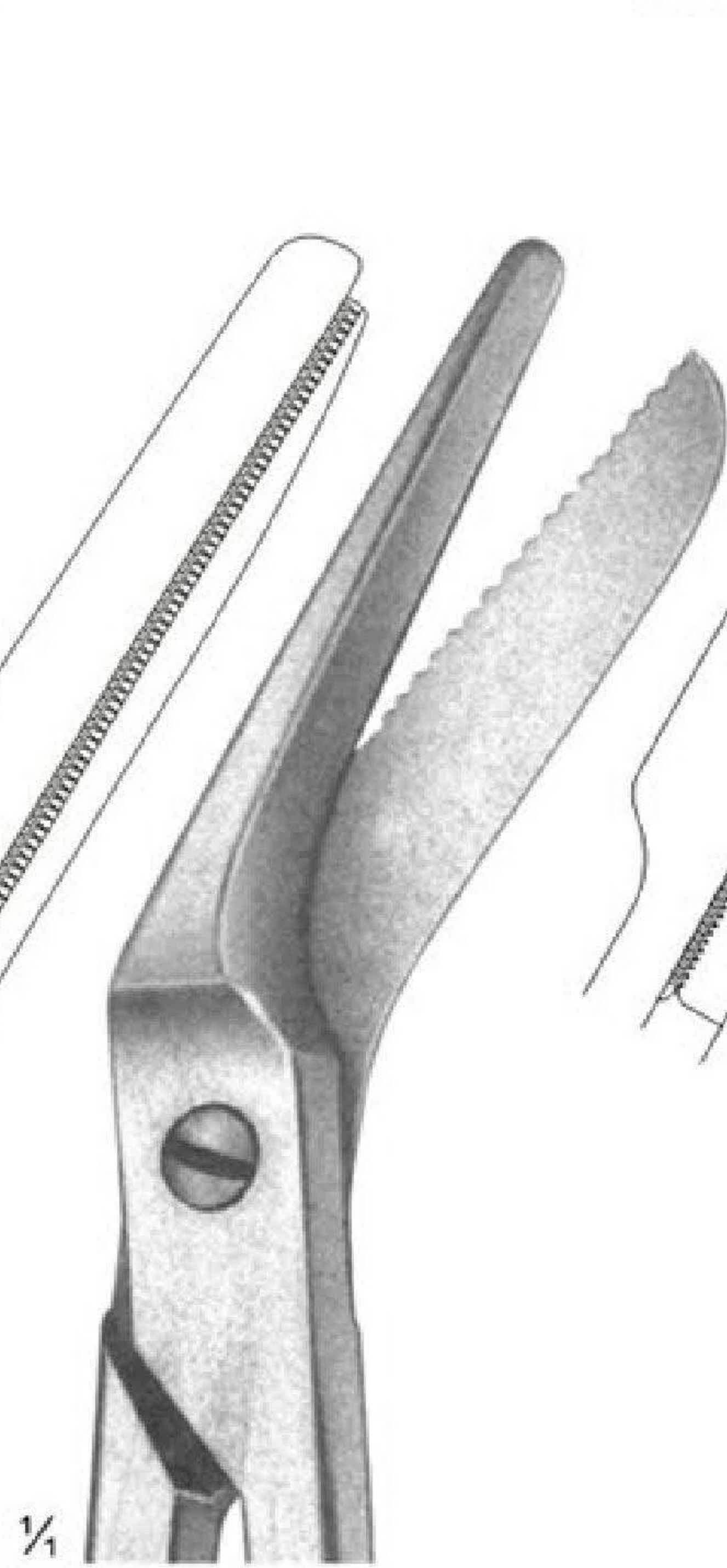

02-3226
 145 mm

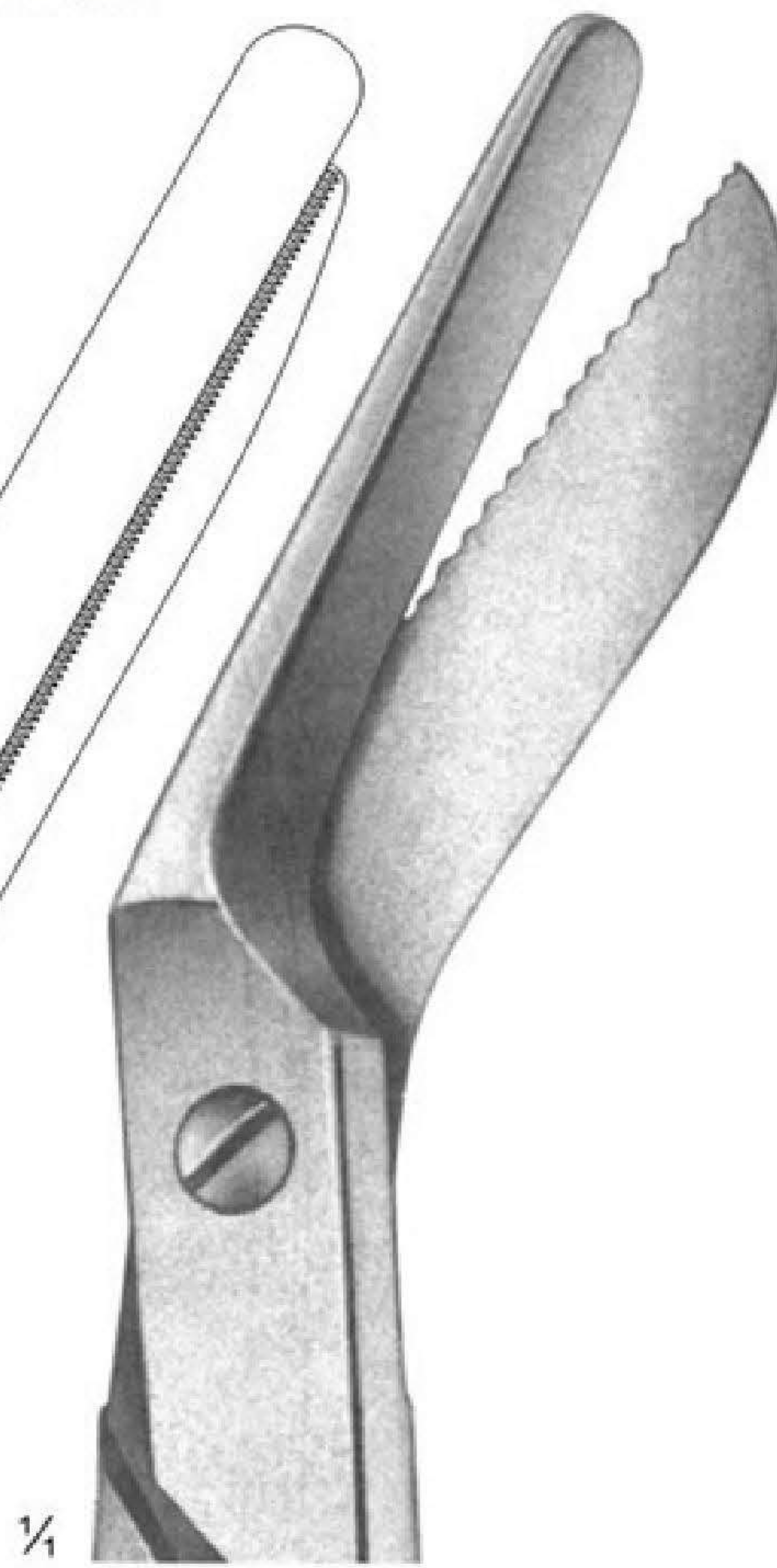

02-3227
 200 mm



02-3228
 Episiotomy Scissors
 240 mm

Bowel Scissors, Rectal Scissors

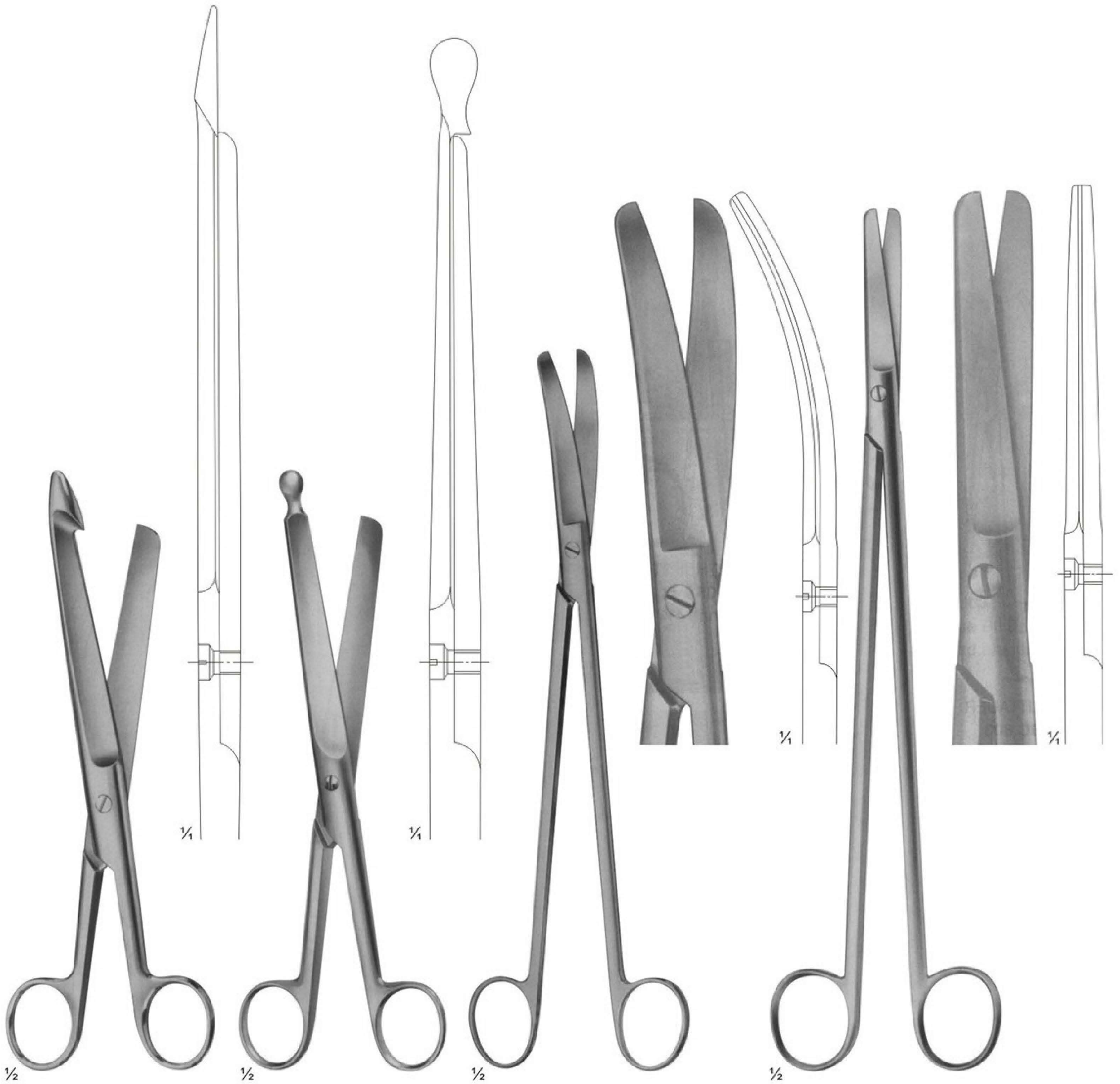

02-3229
 Bowel Scissors
 Size: 210 mm

02-3230
 Bowel Scissors
 Size: 210 mm

02-3231
 LLOYD-DAVIES
 (GOLIGHER'S)
 Rectal Scissors
 Size: 270 mm

02-3232
 STELZNER
 Rectal Scissors
 Size: 310 mm

Ligature Scissors



02-3233 - 02-3234
 SPENCER

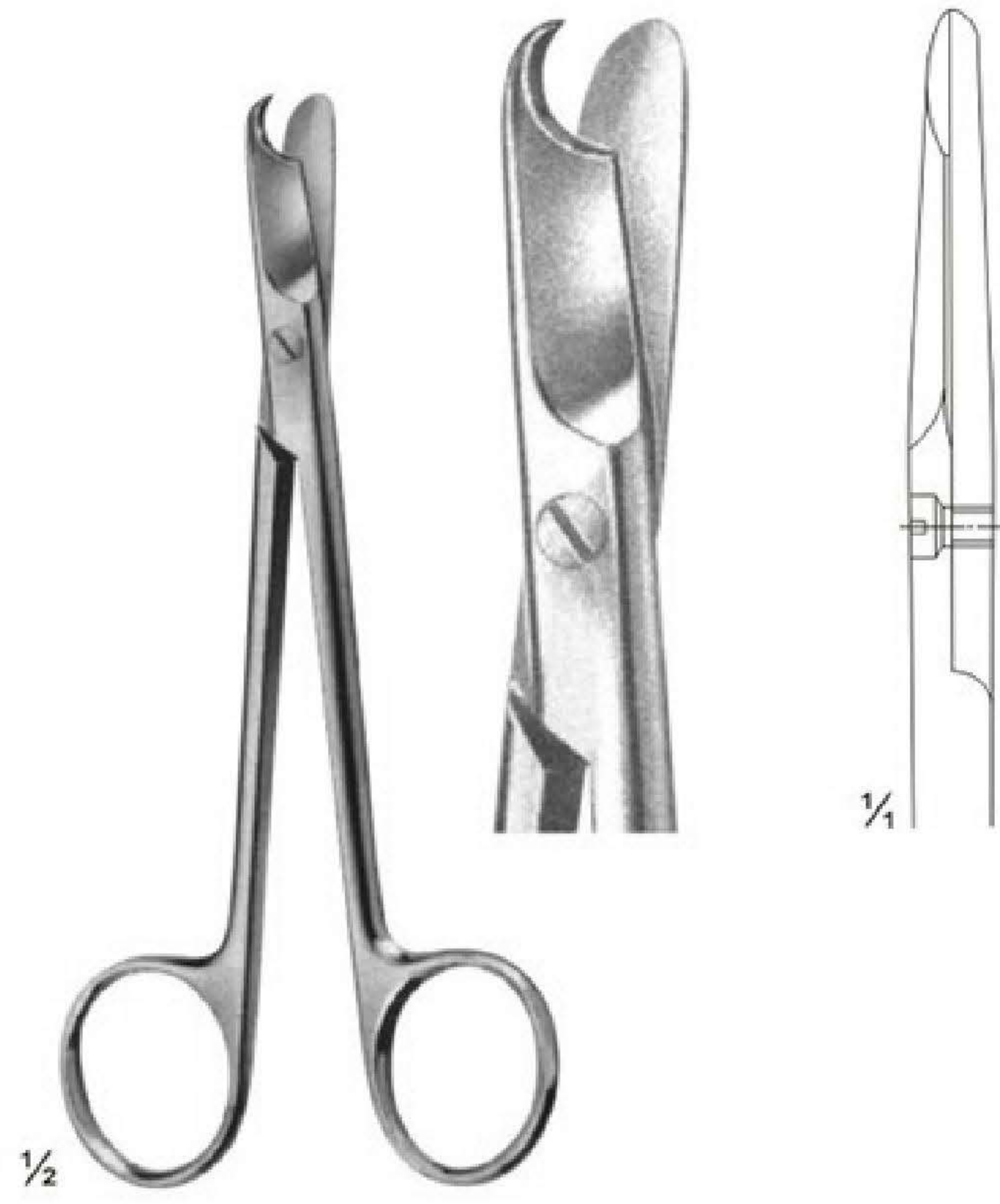

02-3235
 LITTAUER
 Size: 135 mm

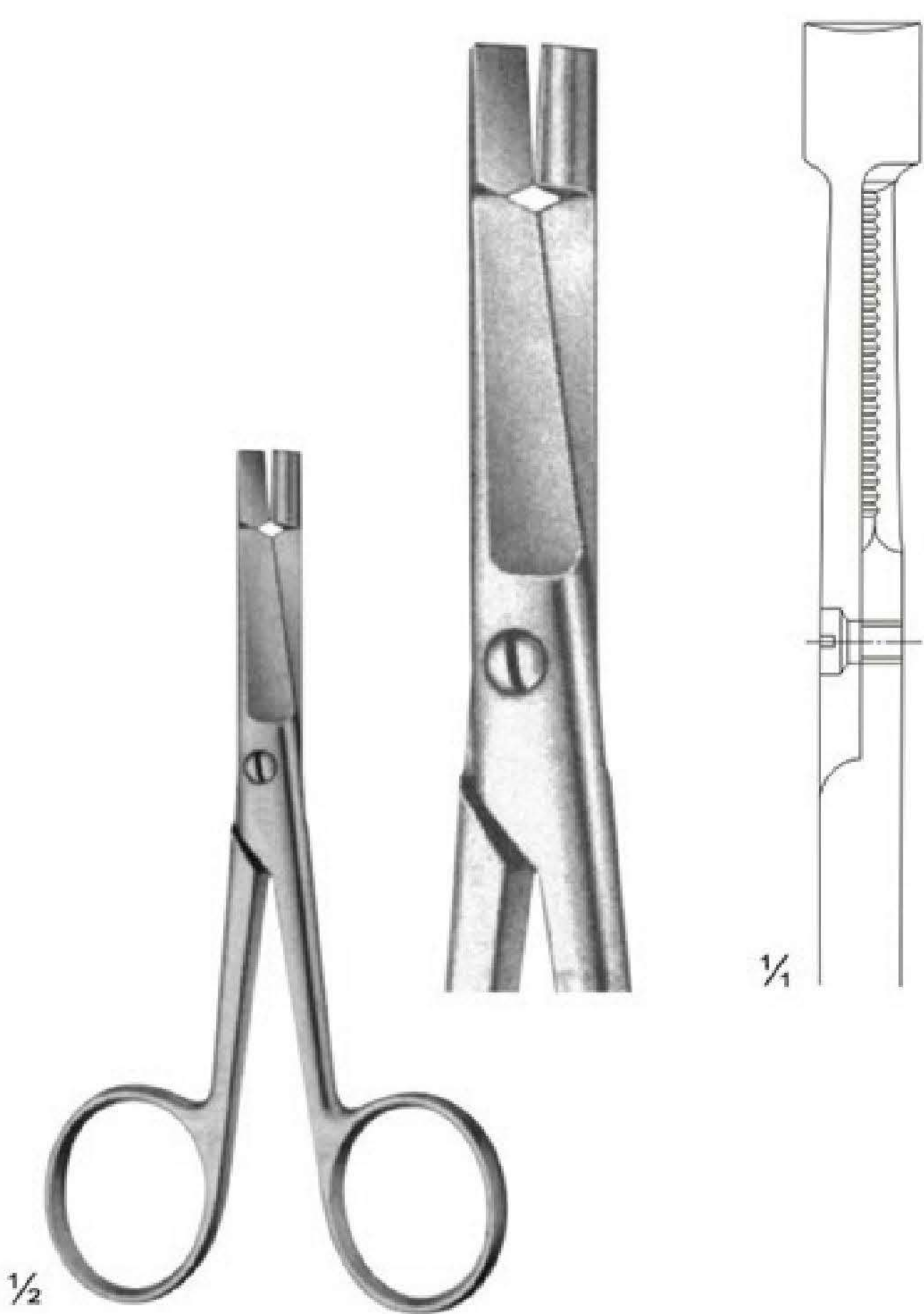

02-3236
 EISELSBERG
 Size: 115 mm

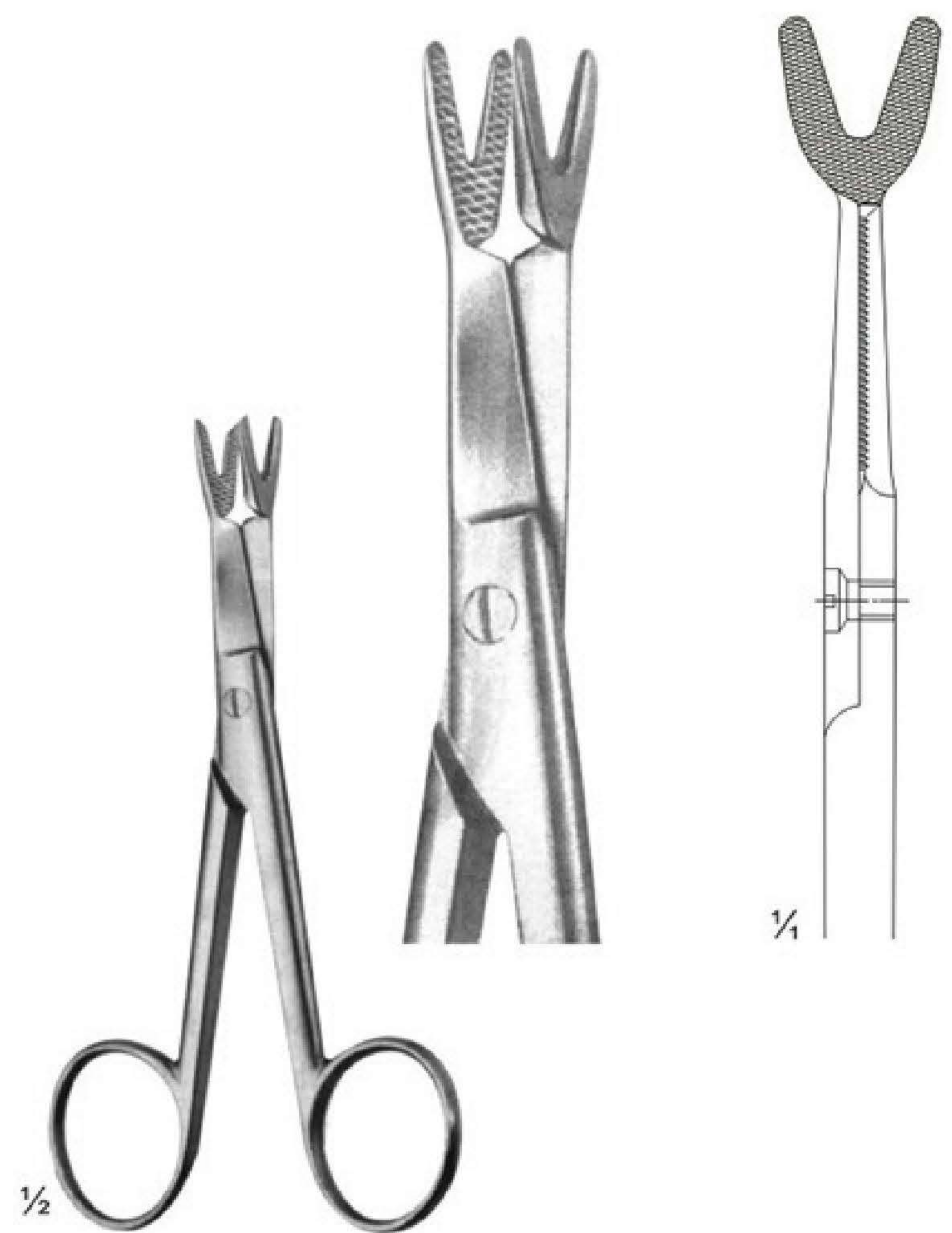

02-3237
 SCHOEMAKER-LOTH
 Size: 125 mm

Wire and Plate Scissors



02-3238

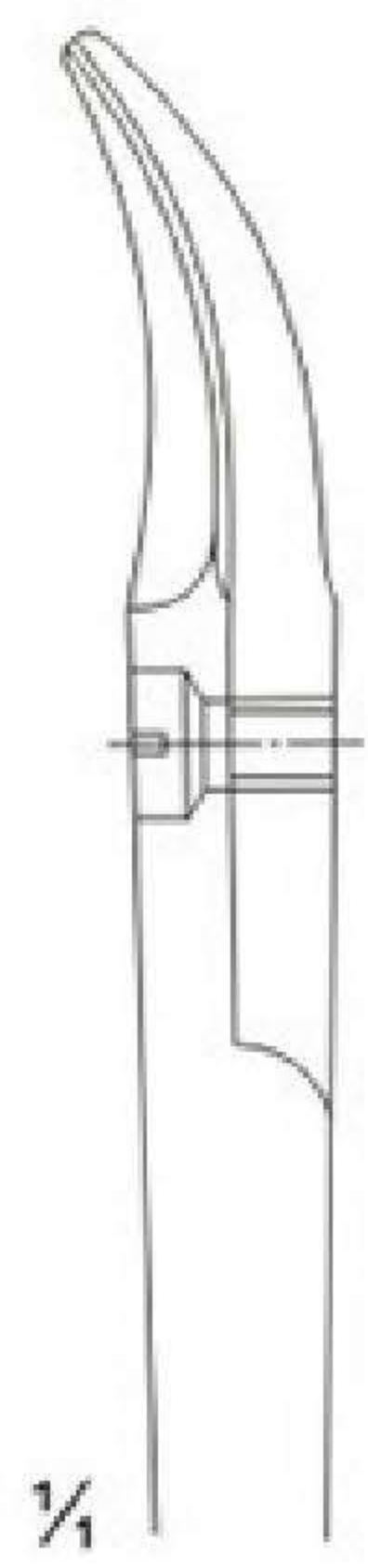

02-3239

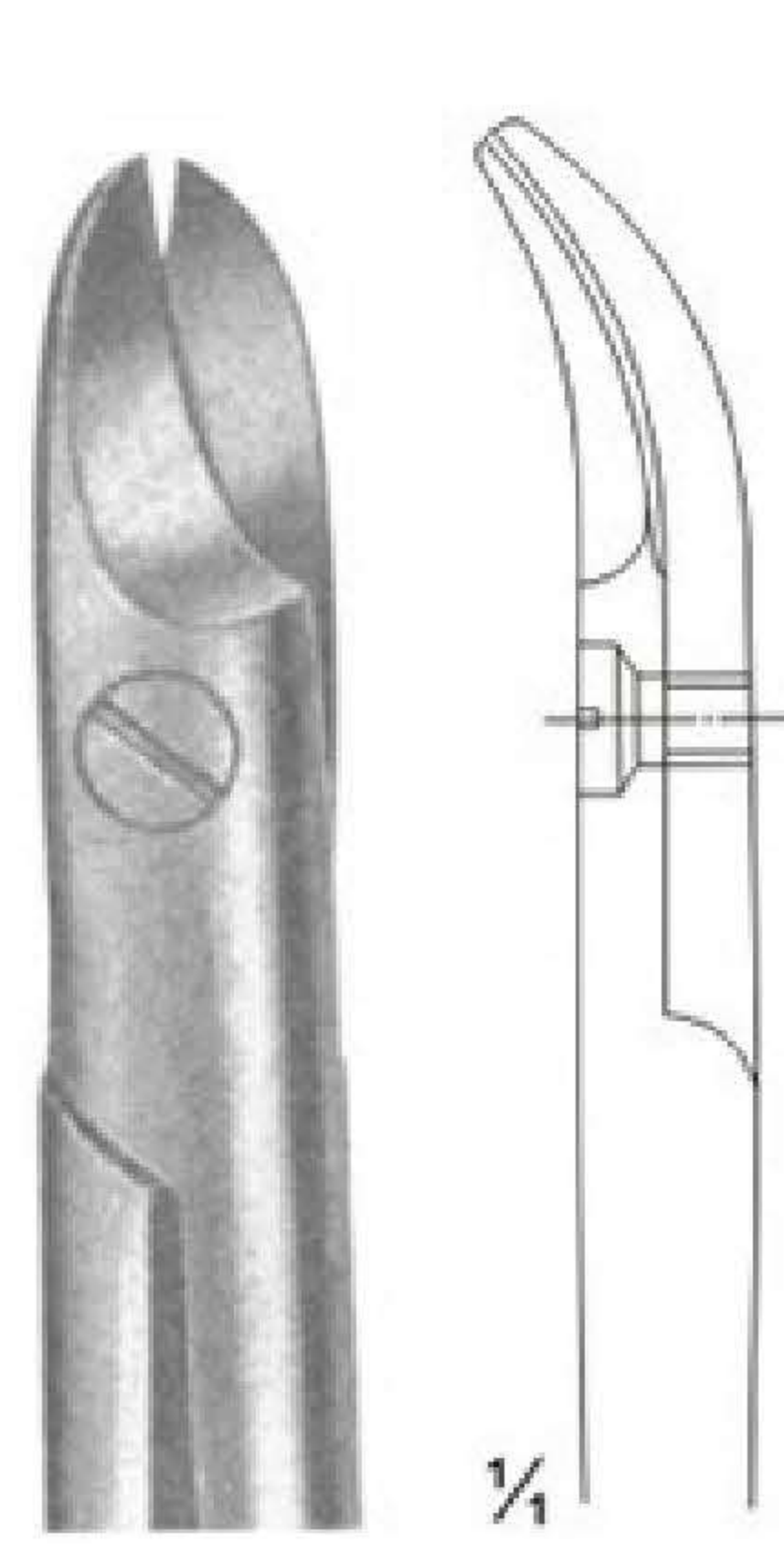

02-3240
 Broad Blades

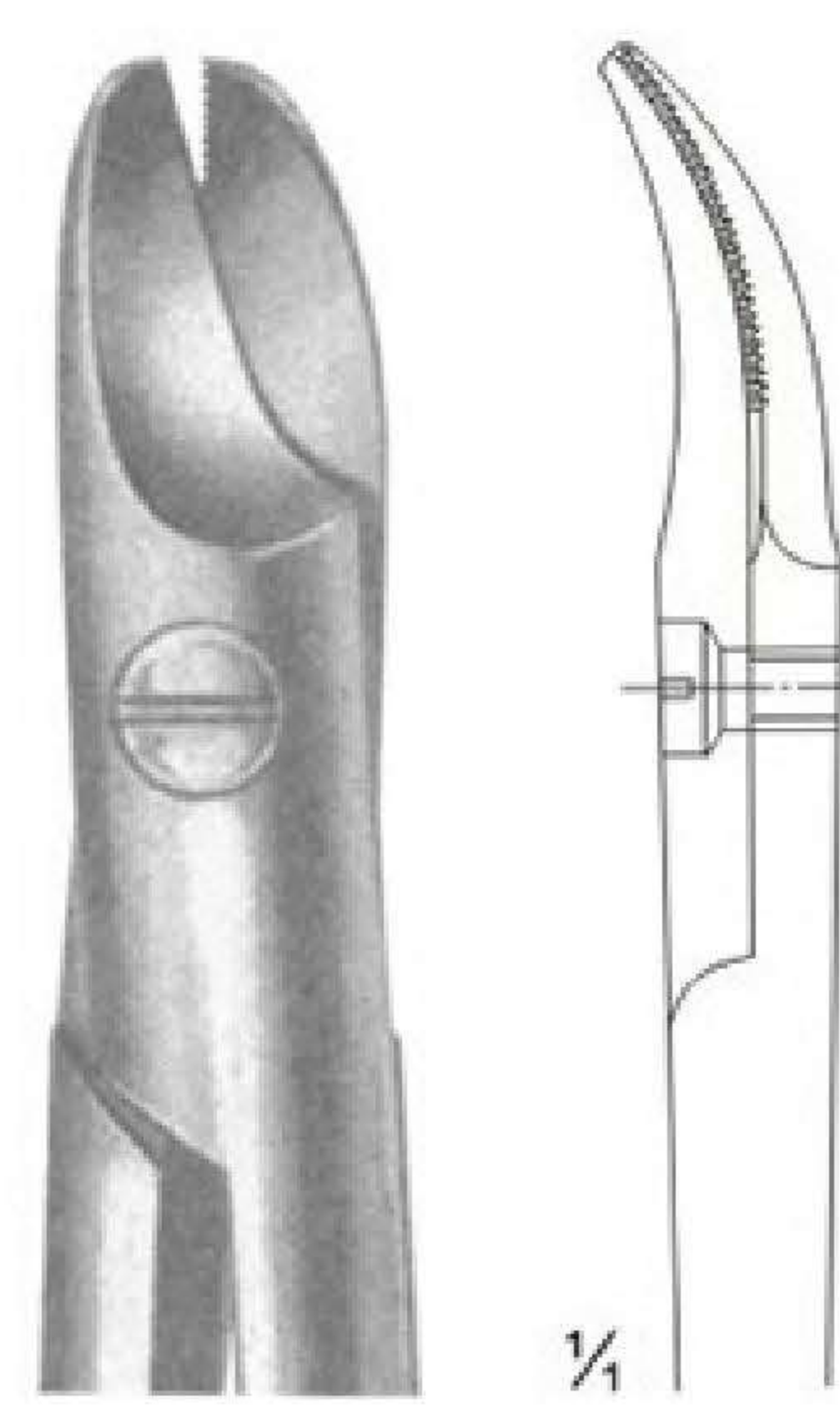

02-3241
 1 Blade Serrated

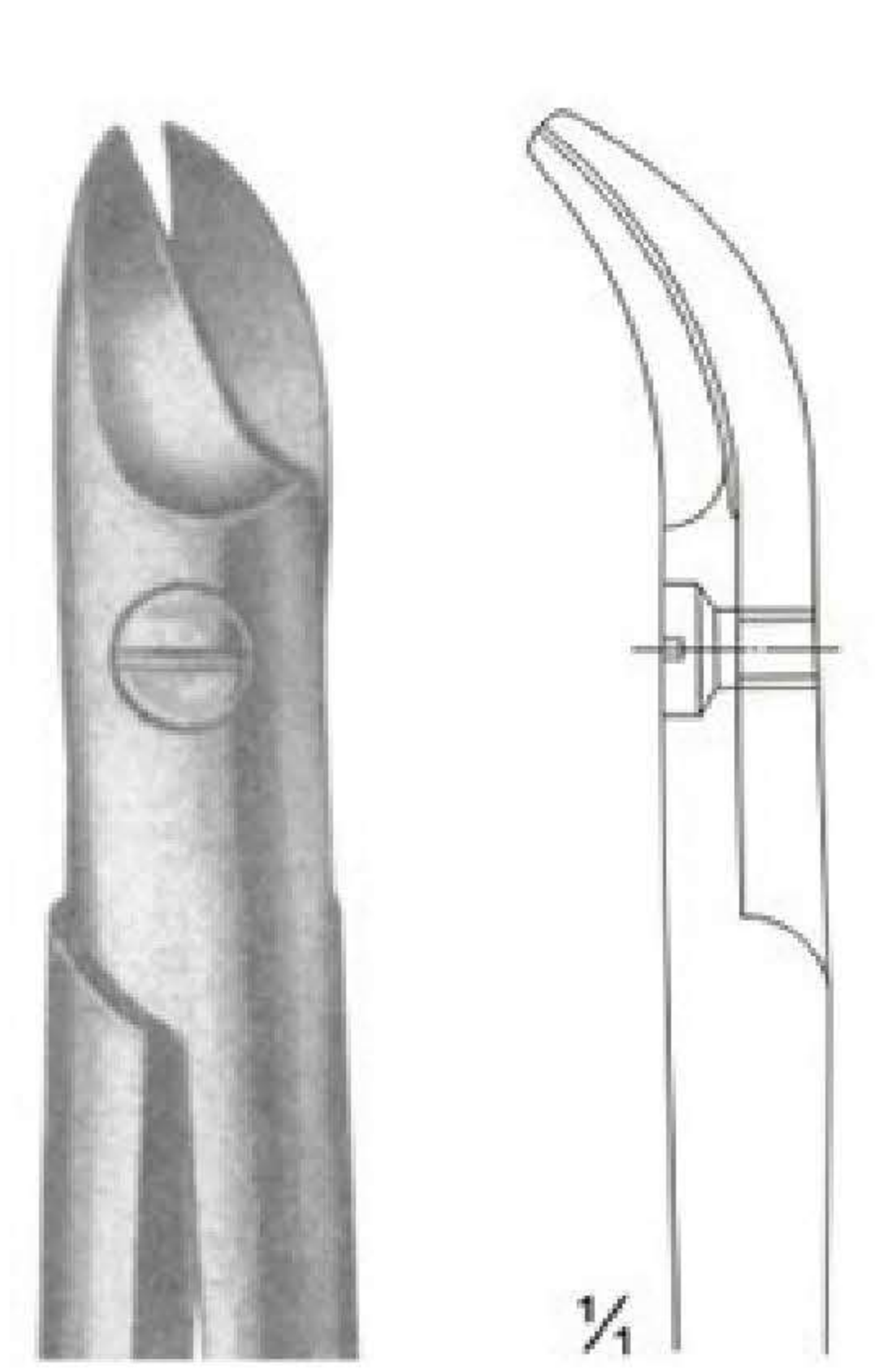

02-3242
 NAUJOKS
 Strongly Curved

02-3238 - 02-3242
 BEEBE
 Size: 110 mm

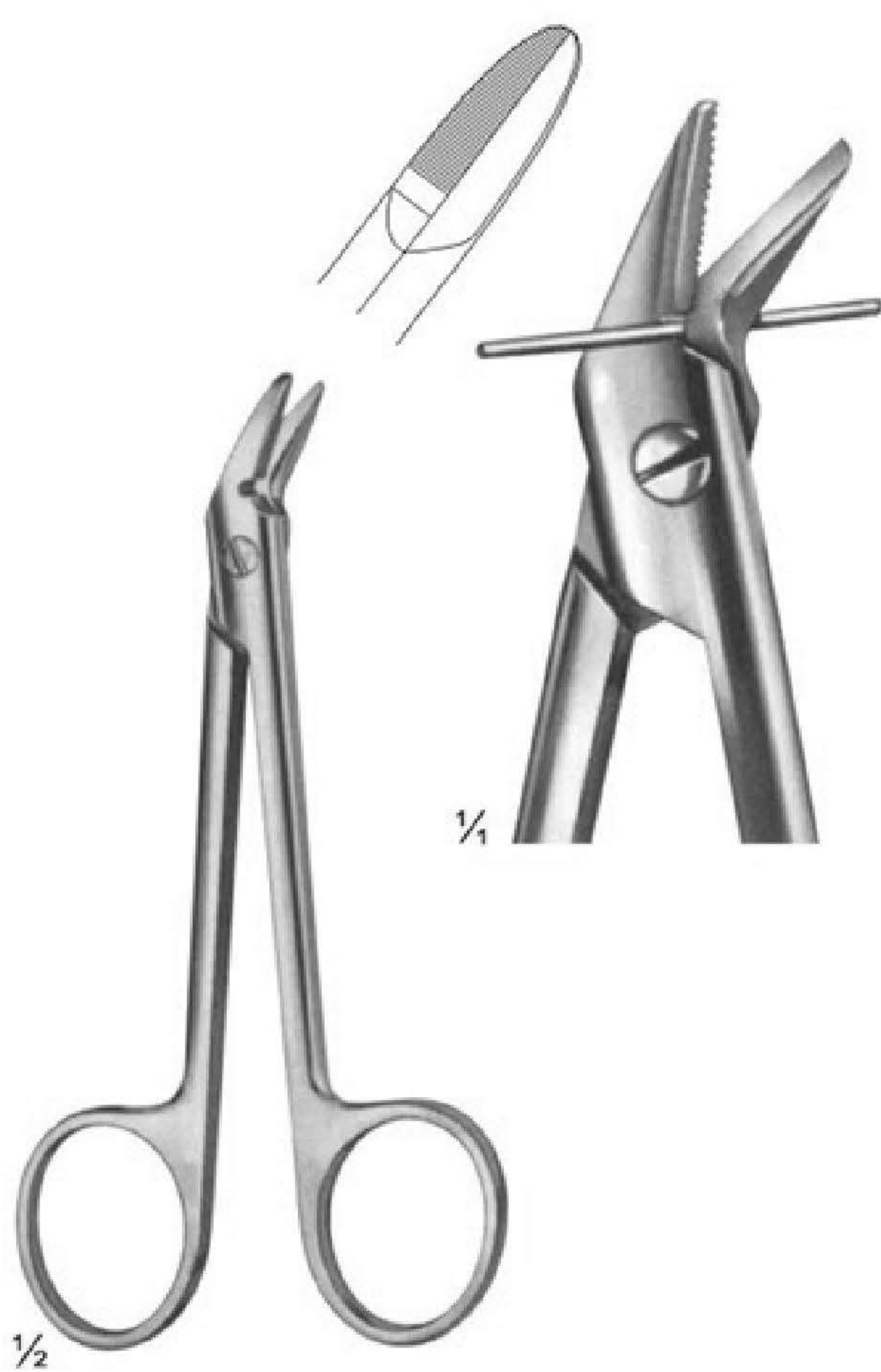

02-3243
 1 Blade Serrated
 Size: 120 mm

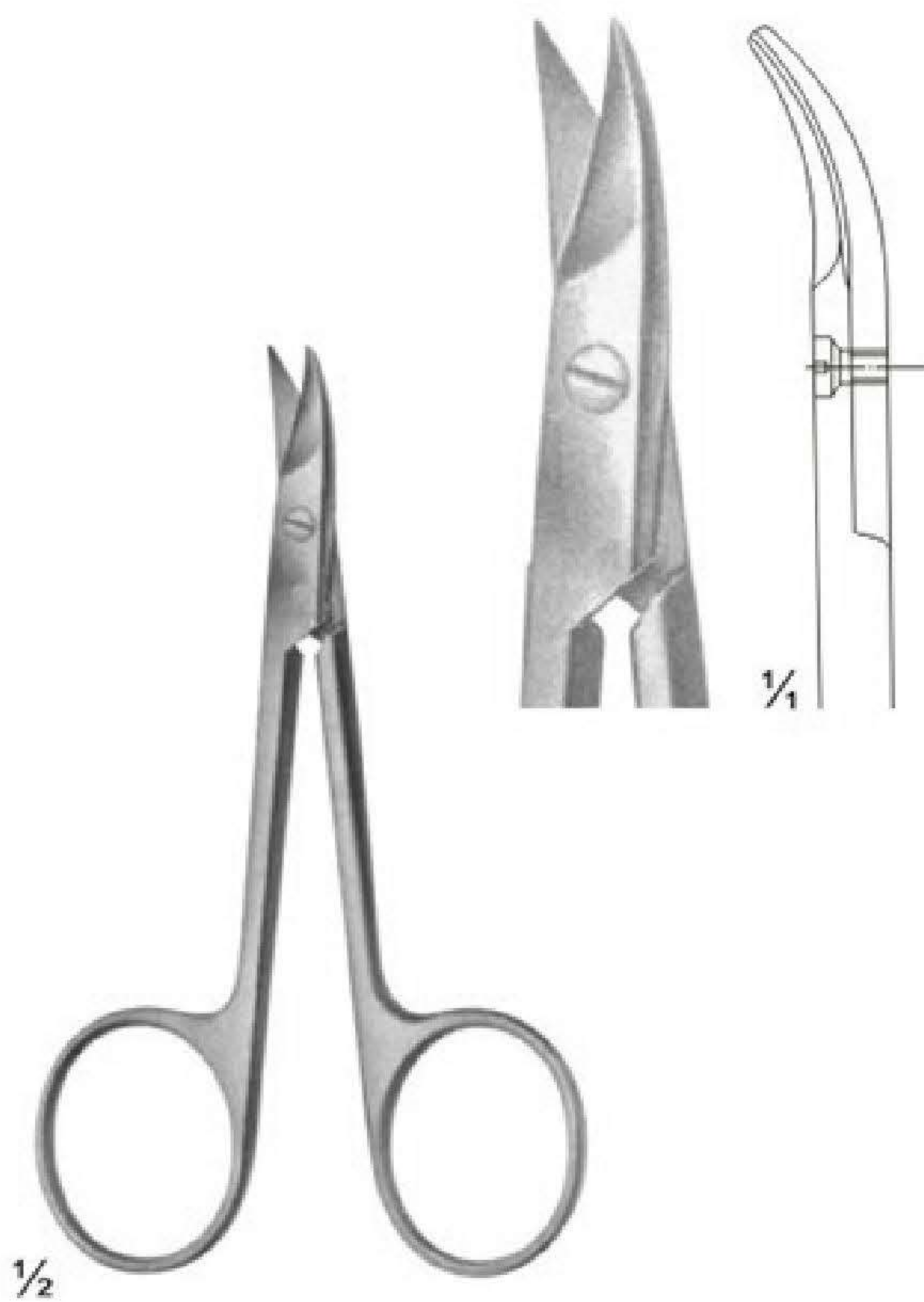

02-3244
 STRACK
 Size: 100 mm

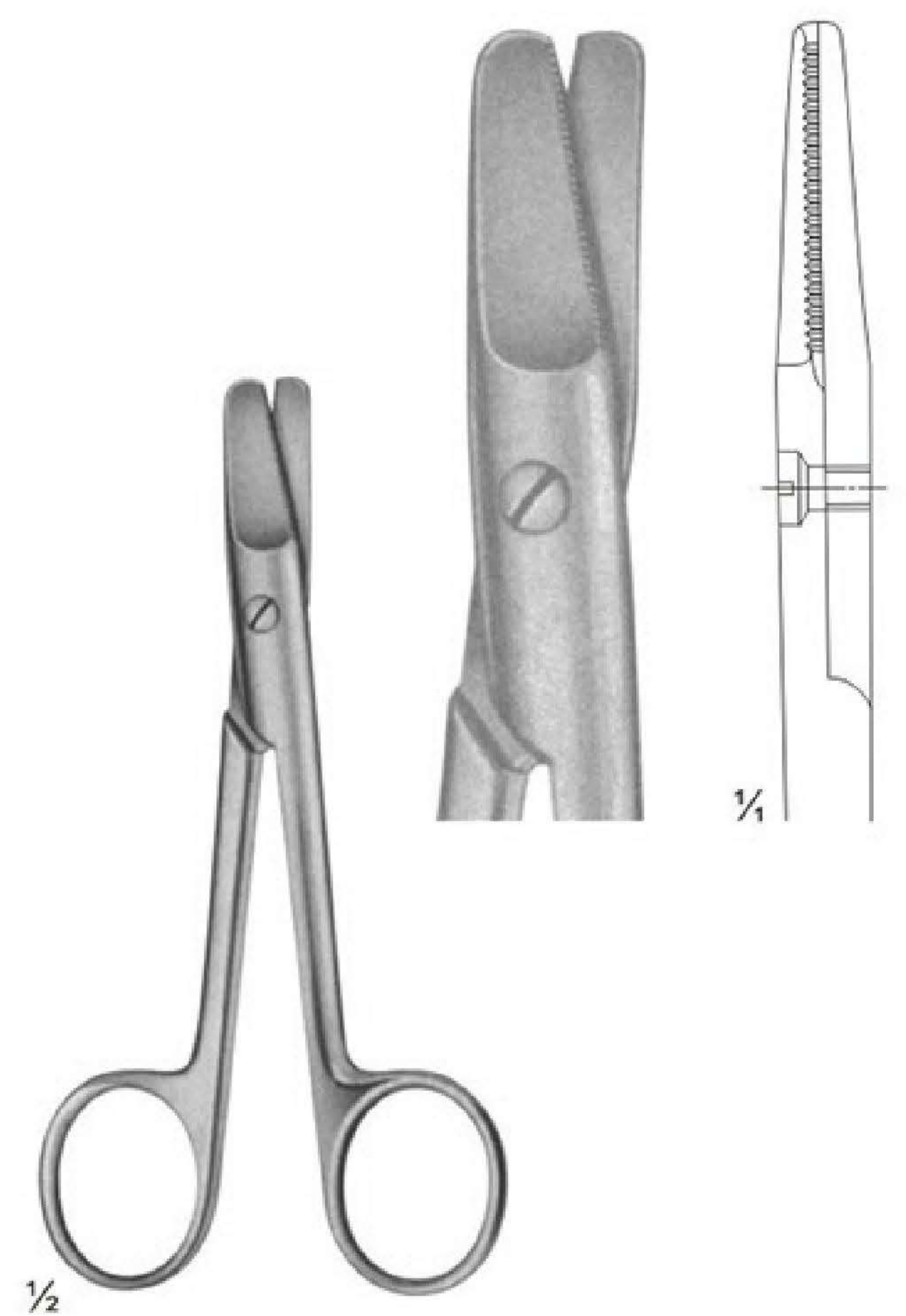

02-3245
 HARVEY
 blades serrated
 Size: 125 mm

Nail and Bandage Scissors

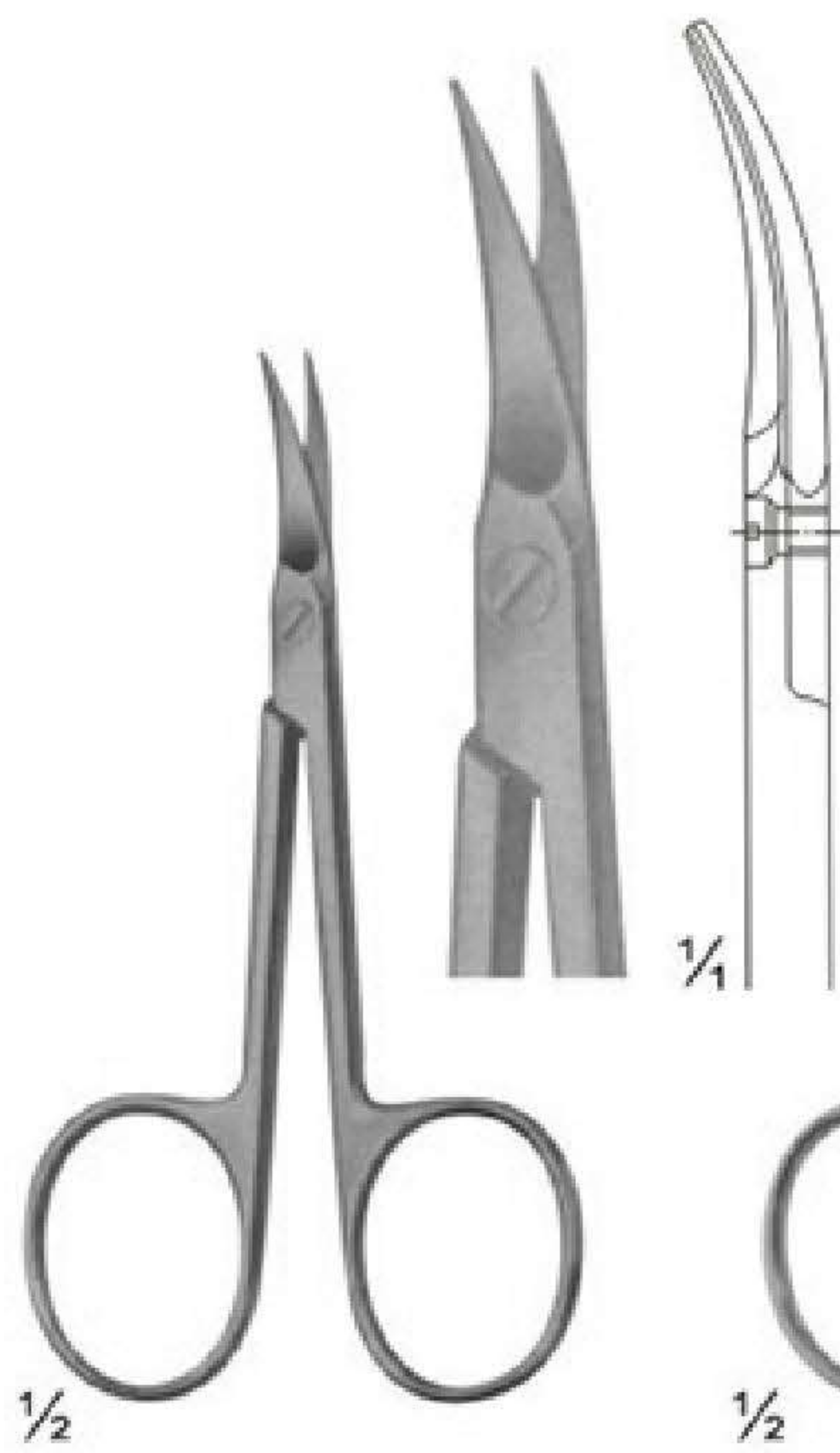

02-3246
 NAIL SCISSORS
 Size: 90 mm

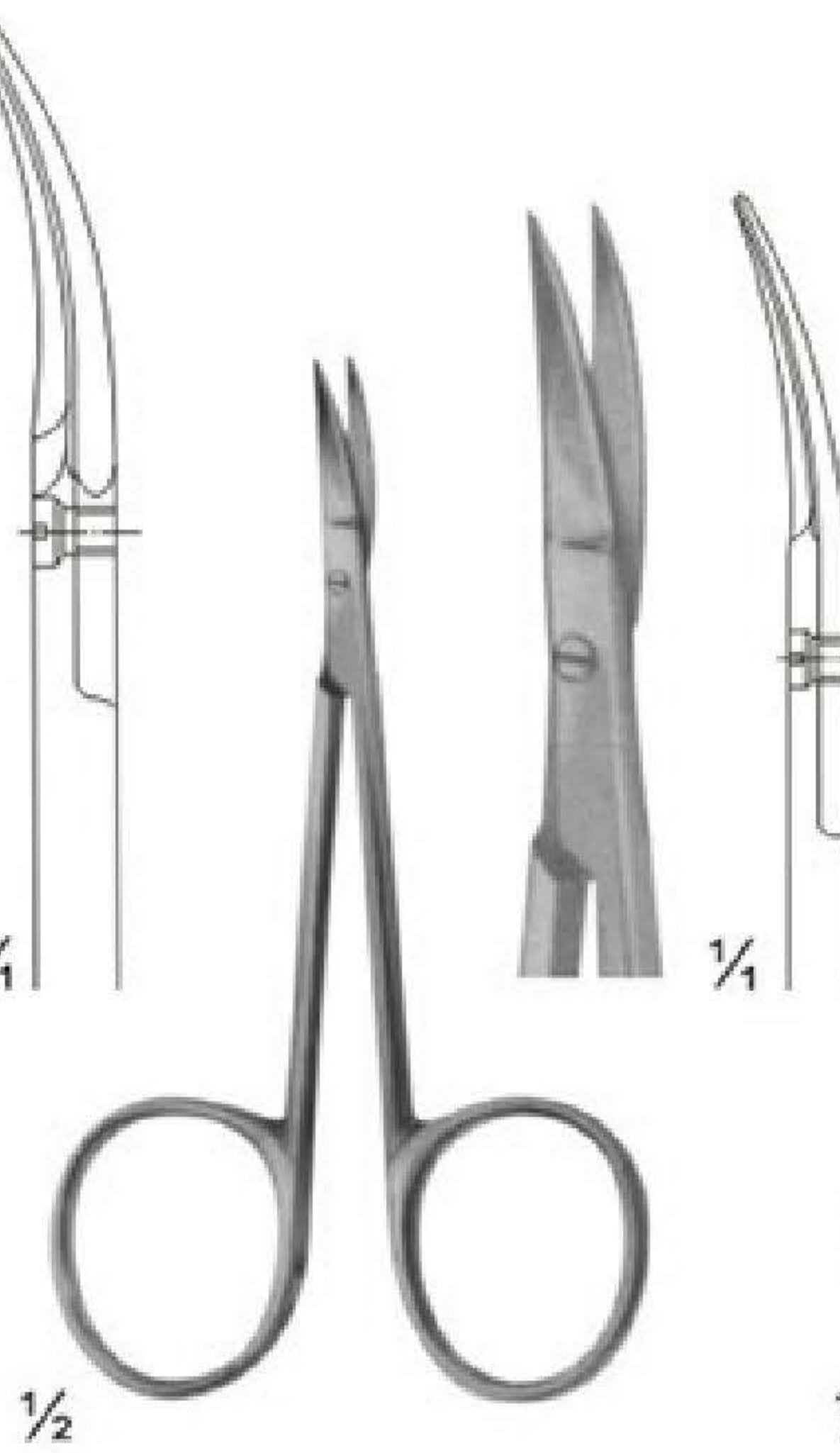

02-3247
 NAIL SCISSORS
 especially fine pattern
 Size: 90 mm

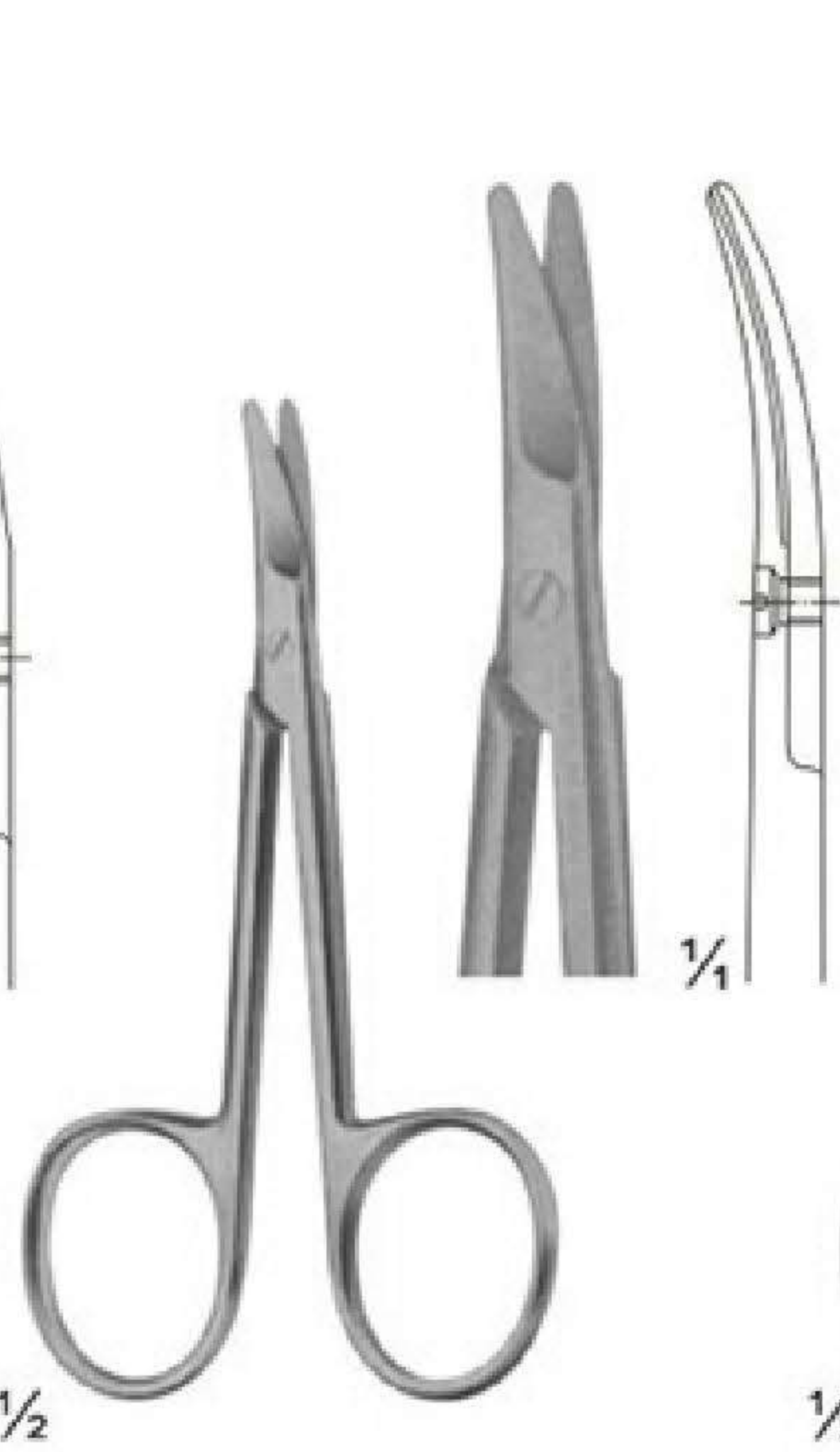

02-3248
 BABY NAIL
 SCISSORS
 Size: 85 mm

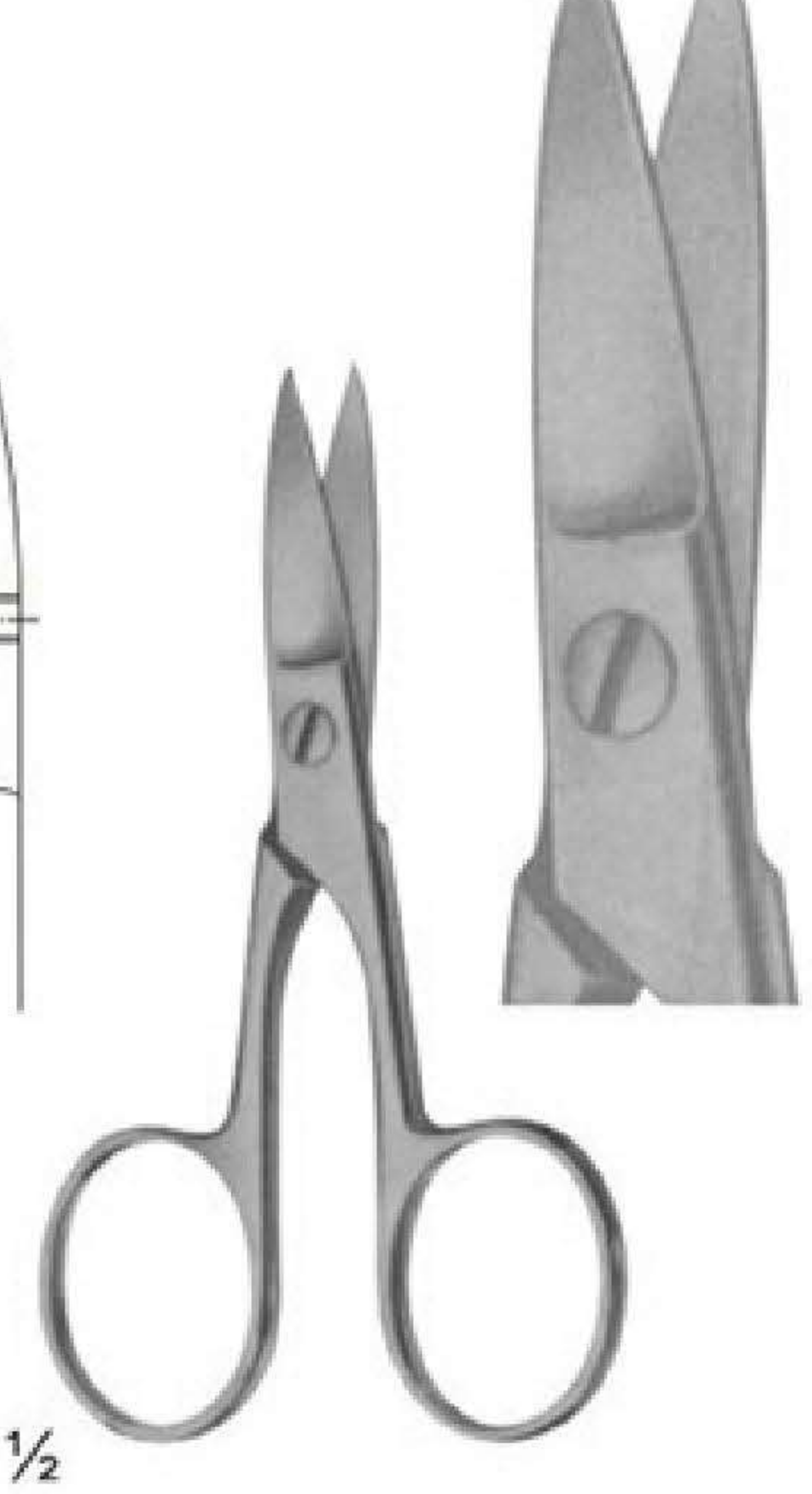

02-3249 - 02-3252
 NAIL SCISSORS
 02-3249(90mm)straight
 02-3250(90mm)curved
 02-3251(100mm)straight
 02-3252(110mm)curved

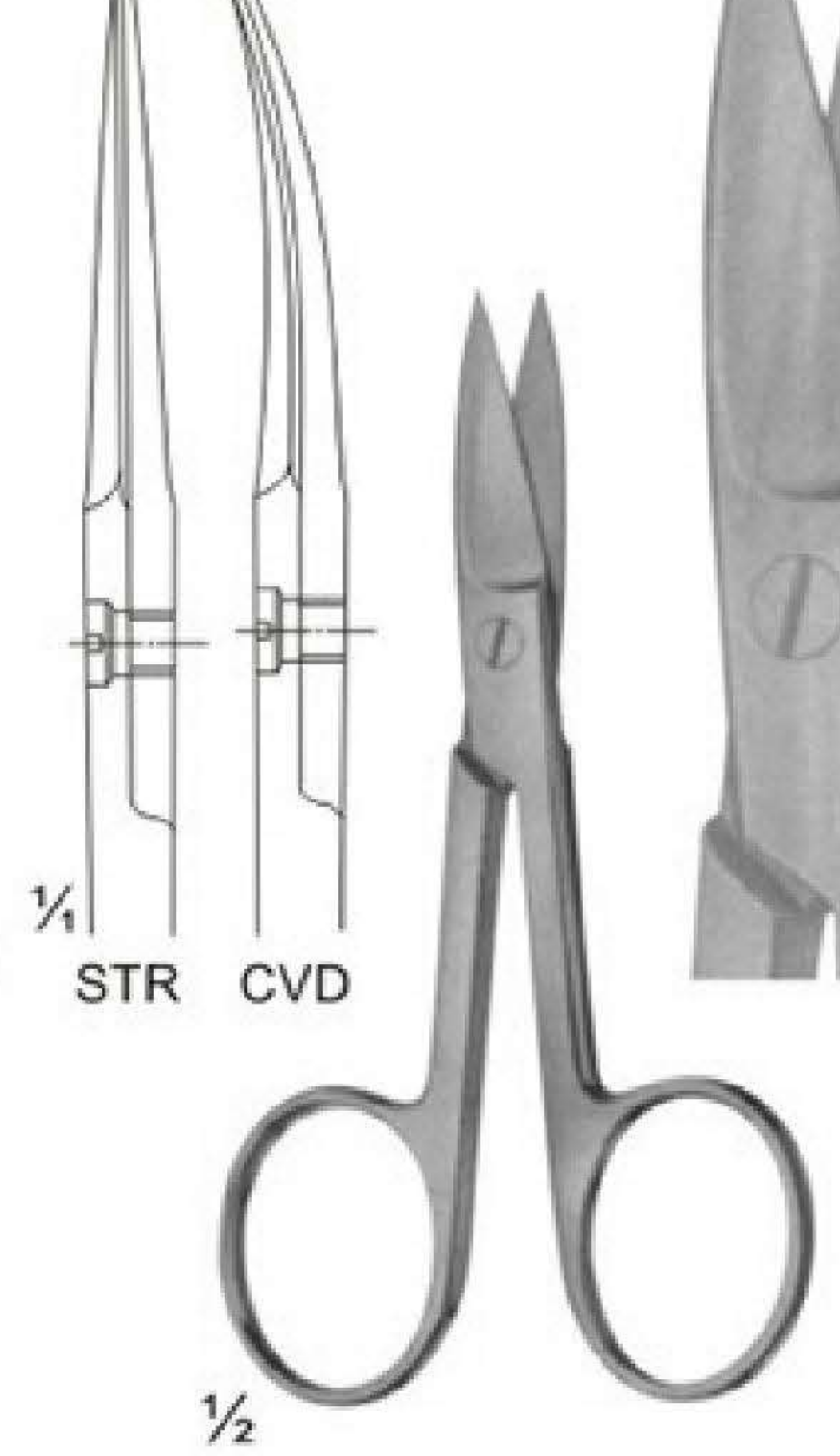

02-3253 - 02-3255
 NAIL SCISSORS
 02-3253(95mm)straight
 02-3254(95mm)curved
 02-3255(105mm)straight

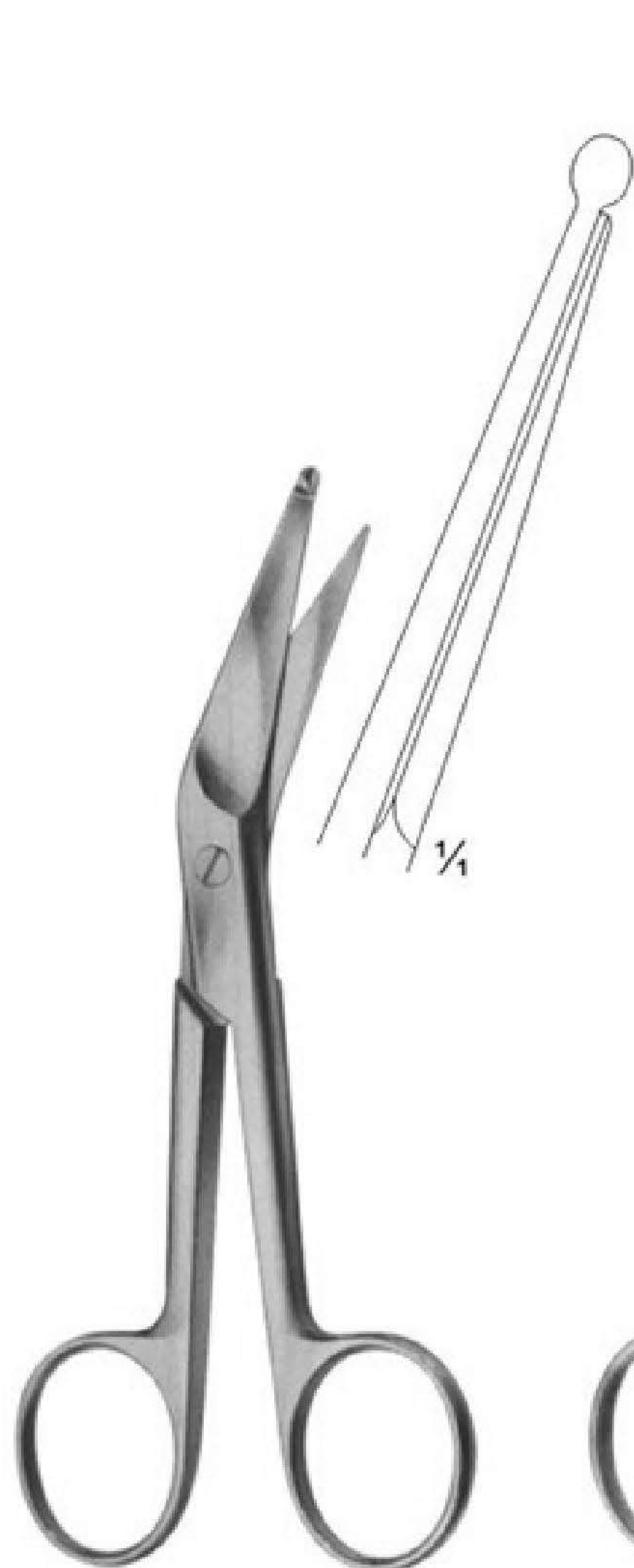

02-3256
 KNOWLES
 Size: 140 mm

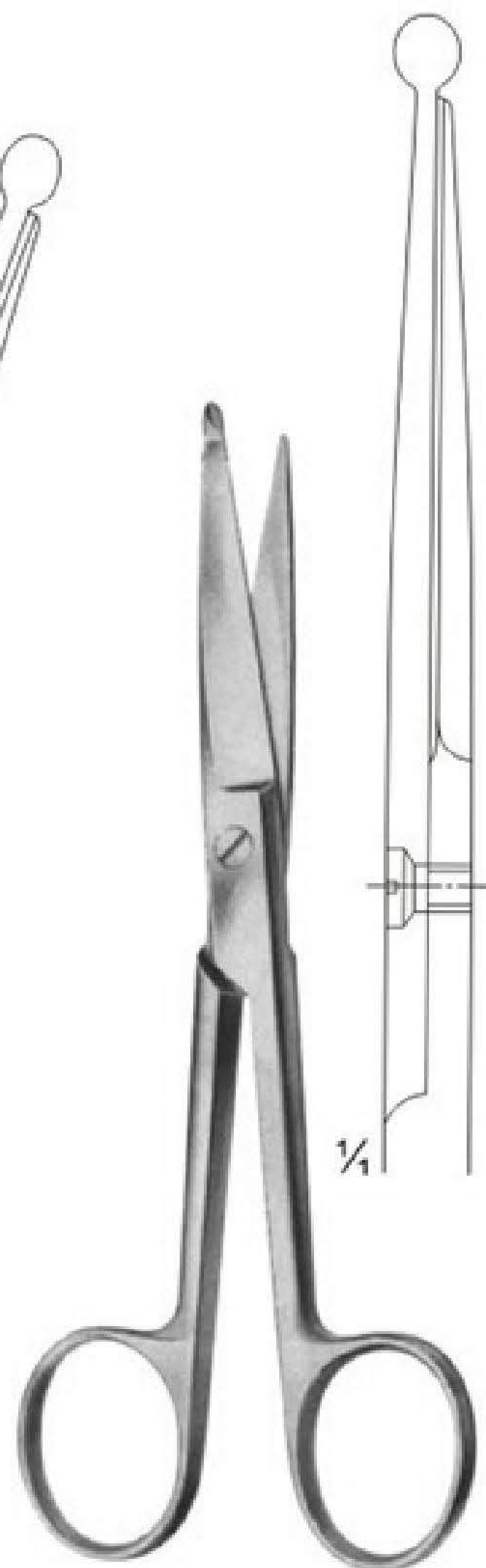

02-3257
 KNOWLES
 Size: 145 mm

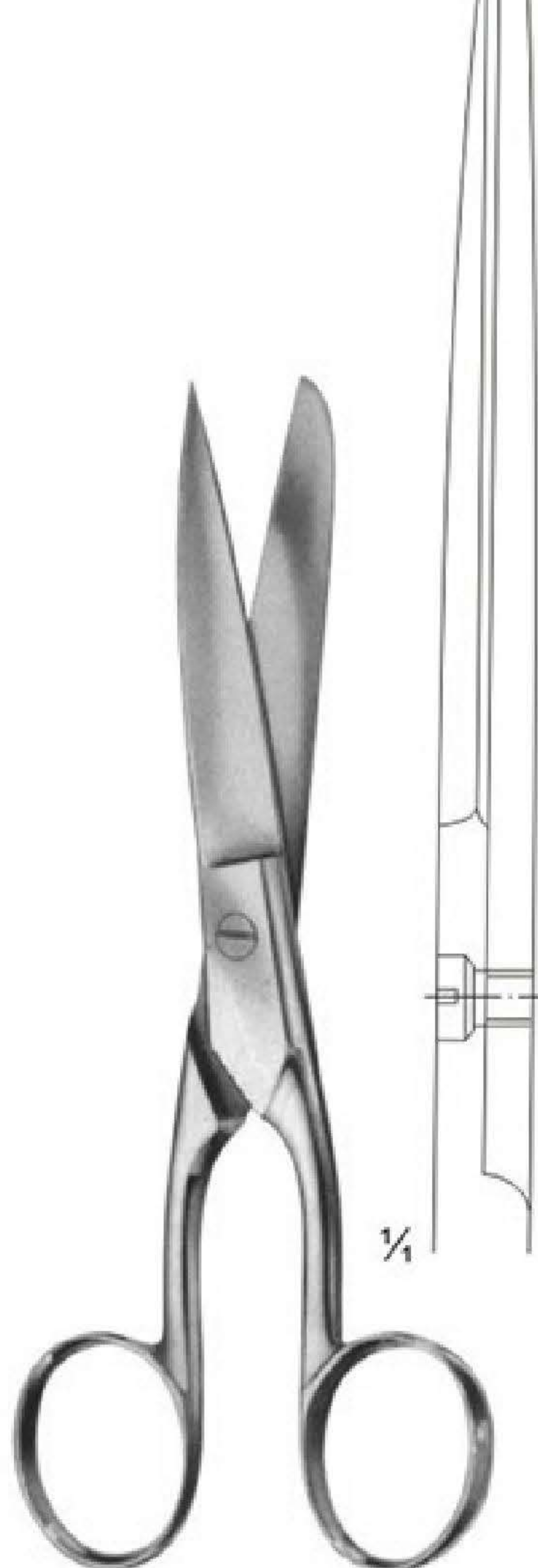

02-3258
 Size: 150 mm

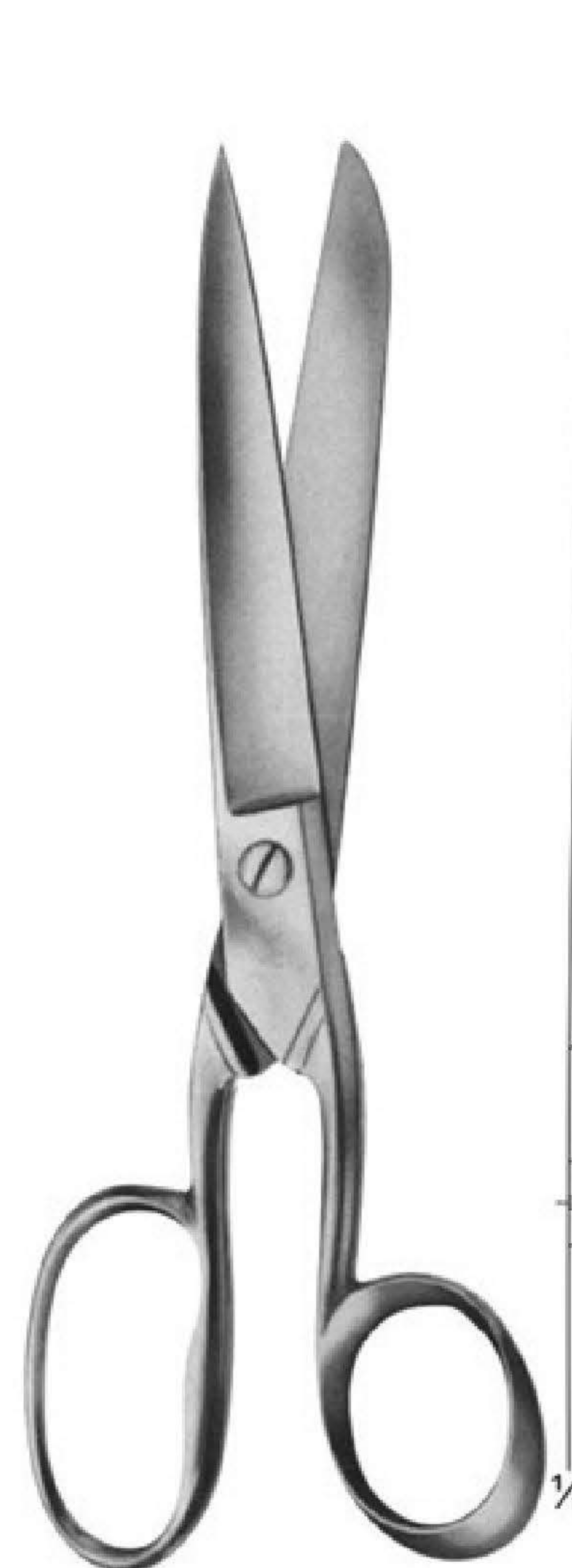

02-3259
 SMITH
 Size: 180 mm

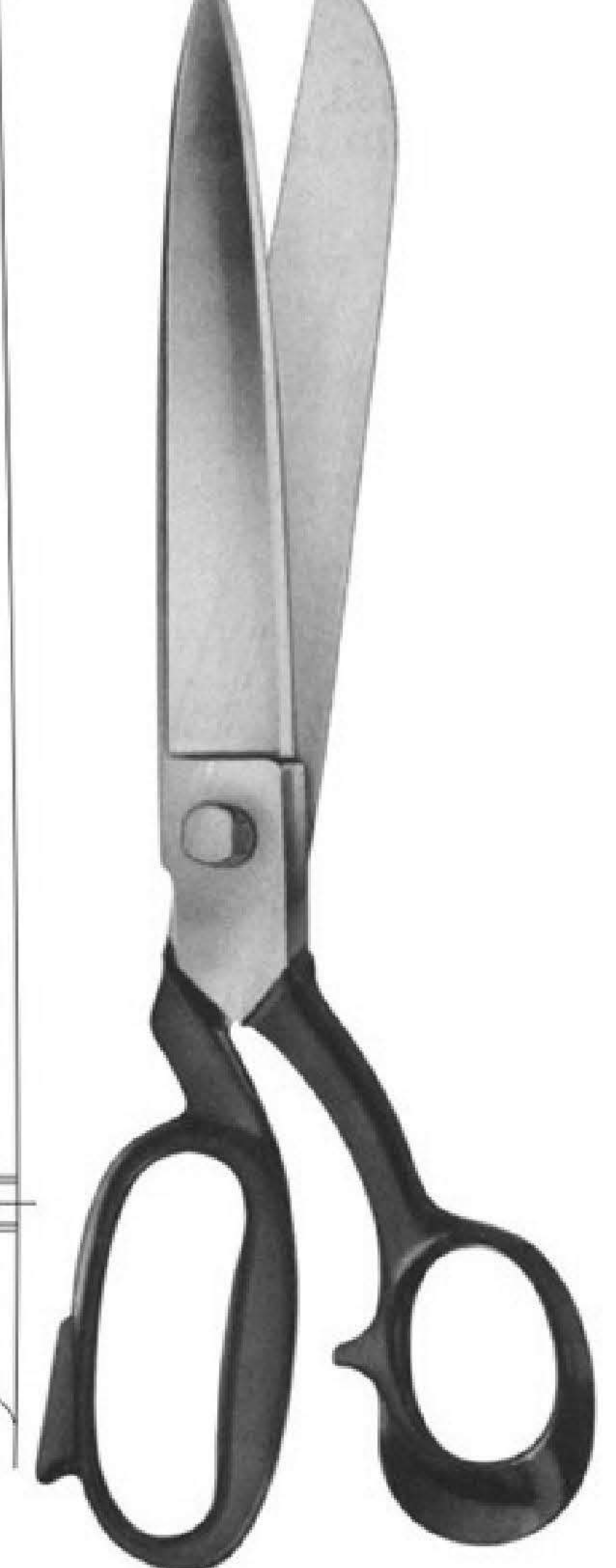

02-3260
 BANDAGE CUTTING
 SCISSORS
 Size: 310 mm

Bandage and Cloth Scissors



$\frac{1}{2}$
02-3261
 UNIVERSAL BANDAGE & CLOTH SCISSORS,
 WITH TOOTHED EDGES, AUTO CLEAVABLE up to 143 °C
 180 mm

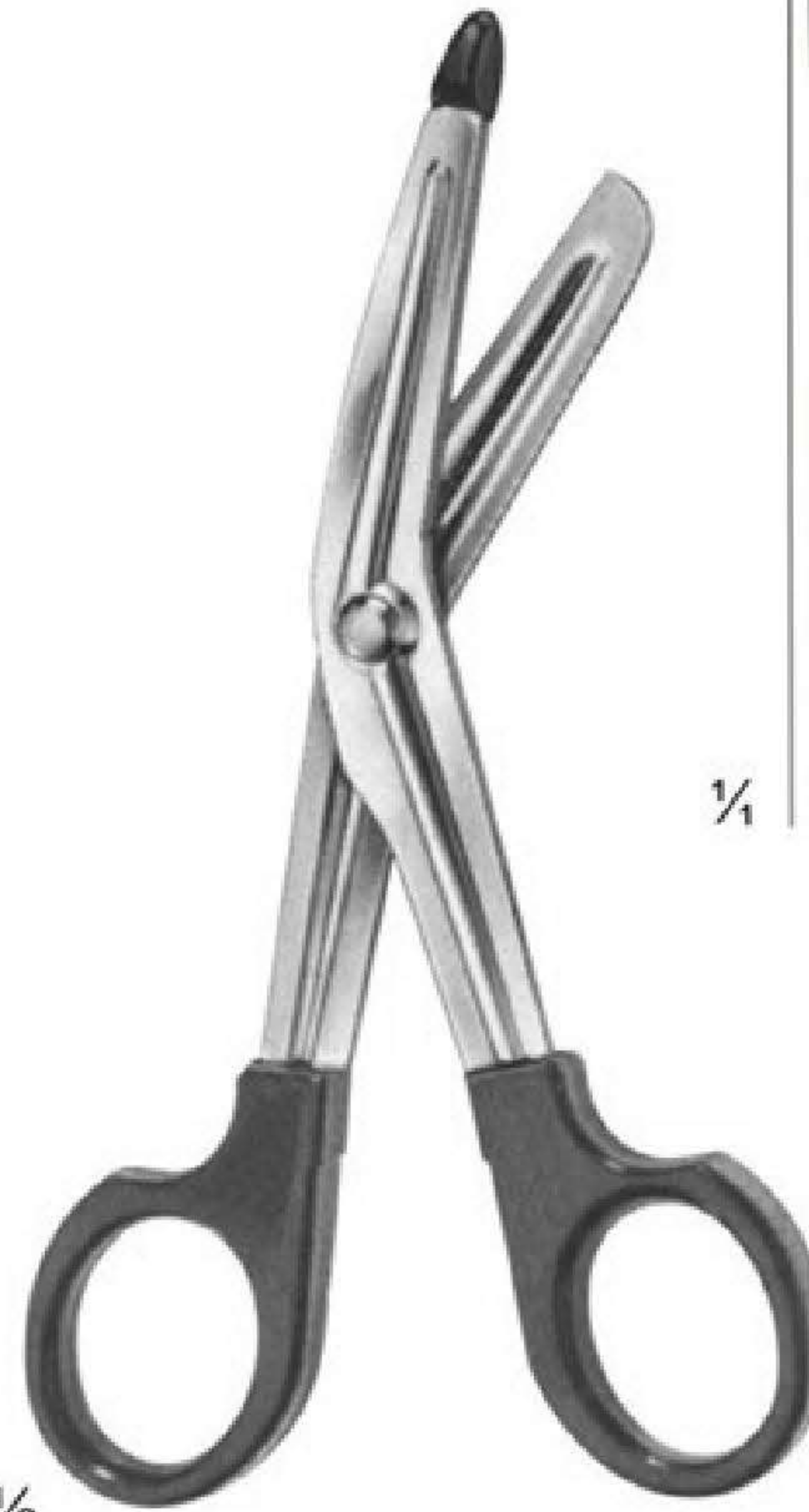
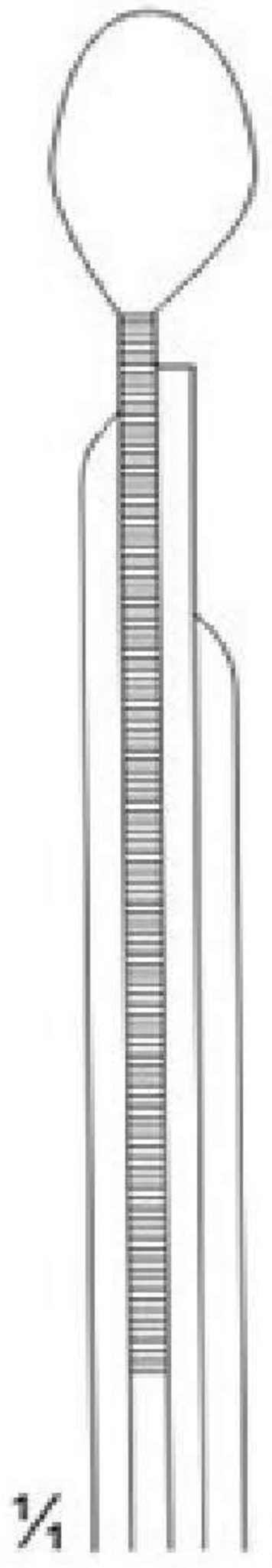

$\frac{1}{2}$
02-3262
 LISTER BANDAGE & CLOTH
 SCISSORS, WITH TOOTHED EDGES,
 AUTO CLEAVABLE up to 143 °C
 Size: 145 mm

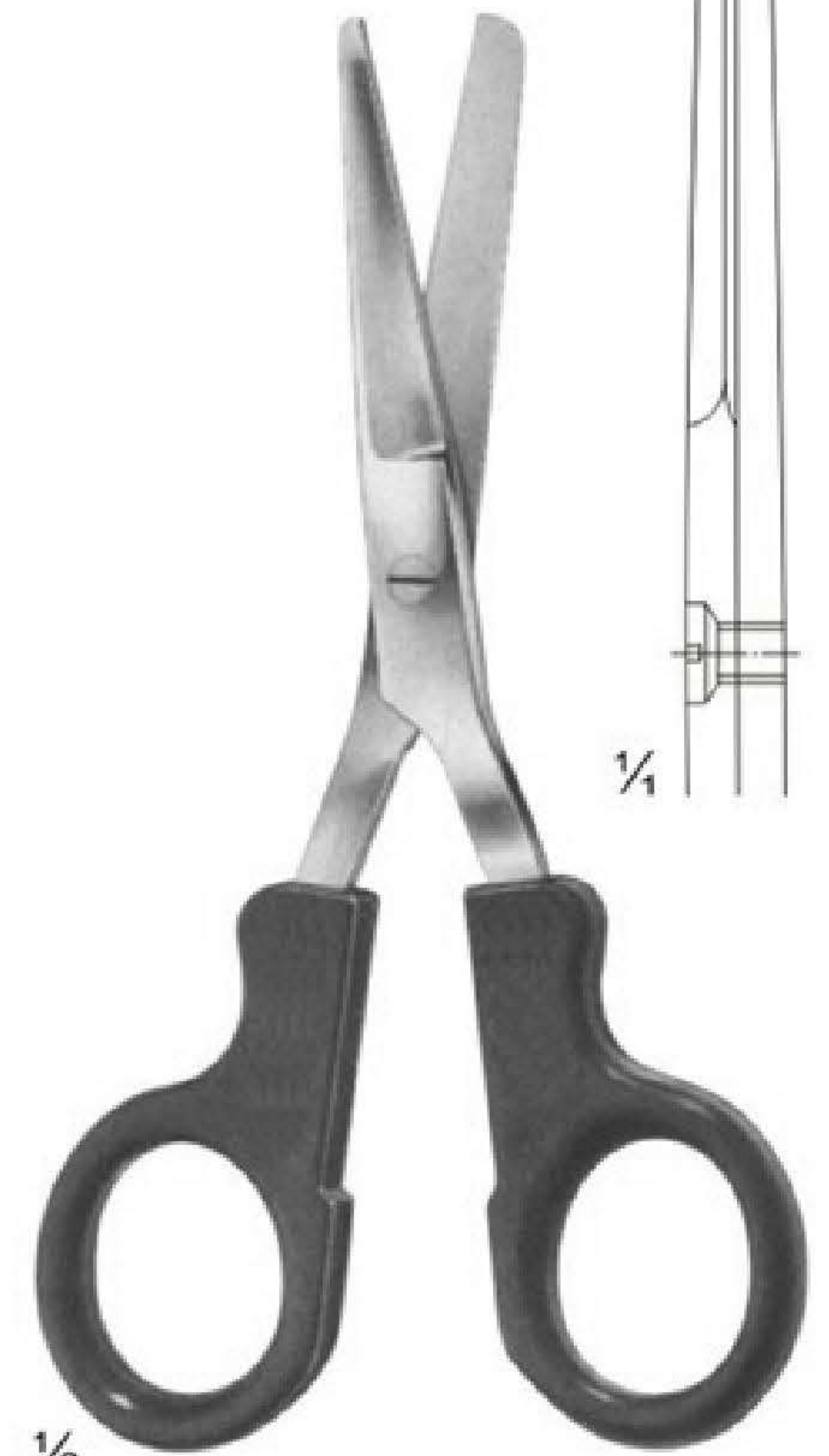
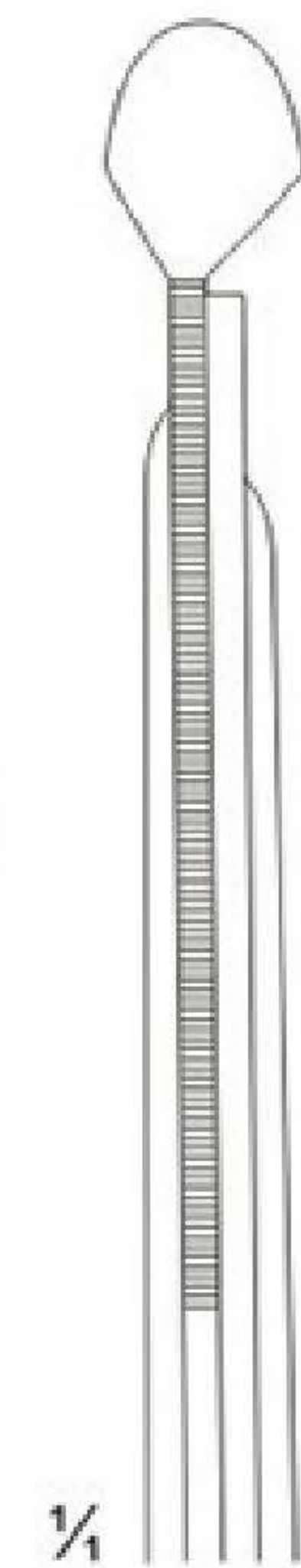

$\frac{1}{2}$
02-3263
 NURSE'S SCISSORS
 Size: 145 mm
 AUTO CLEAVABLE up to 143 °C

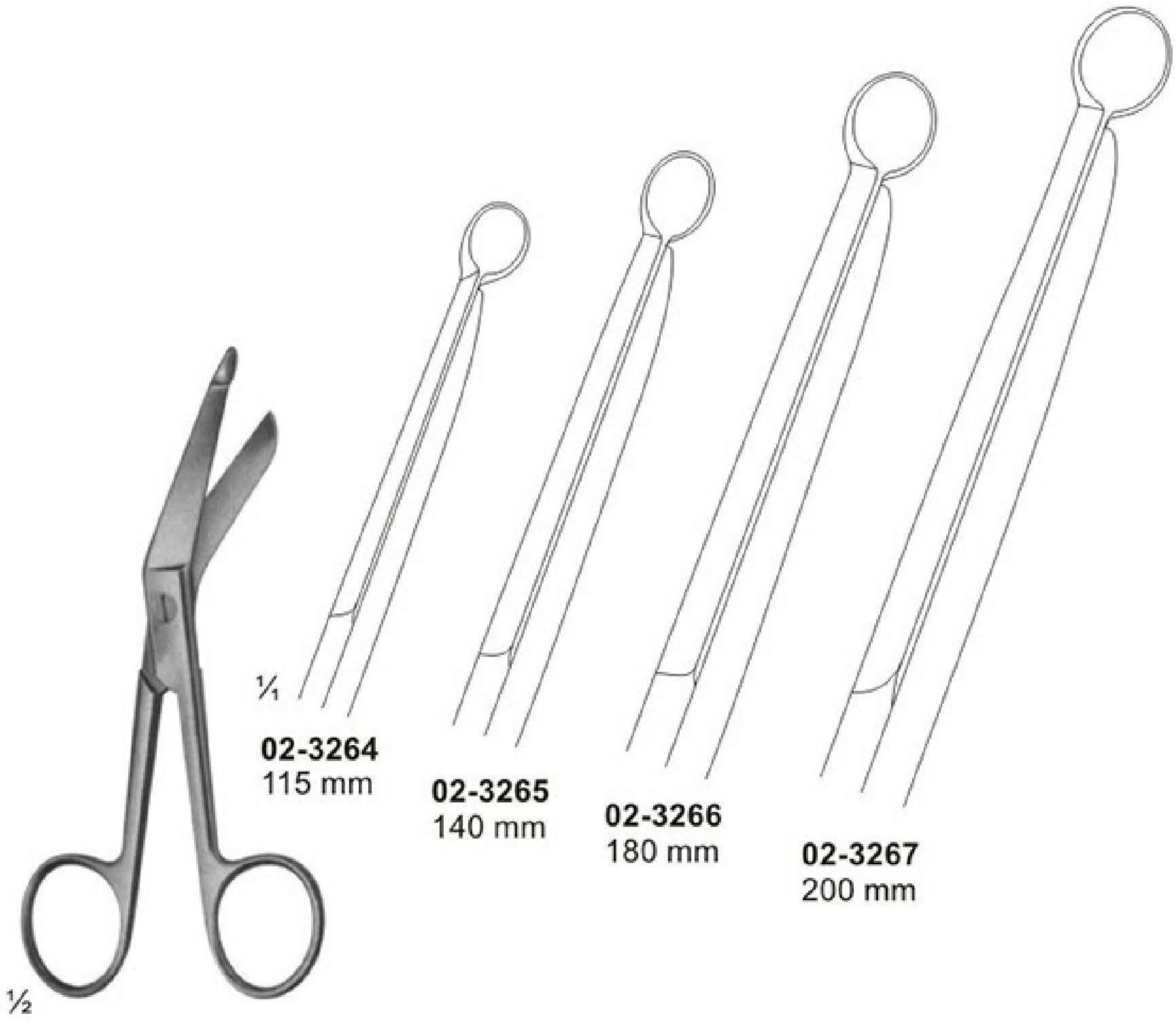
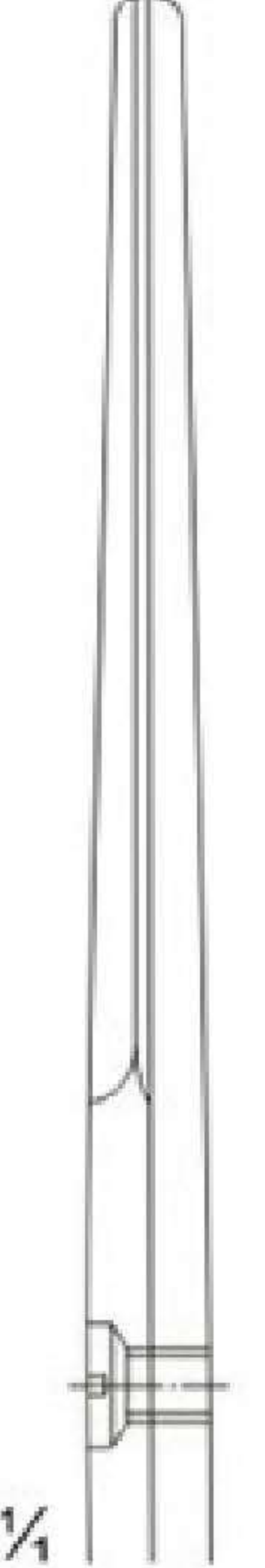

$\frac{1}{2}$
02-3264 - 02-3267
 LISTER

$\frac{1}{4}$
02-3264
 115 mm

02-3265
 140 mm

02-3266
 180 mm

02-3267
 200 mm

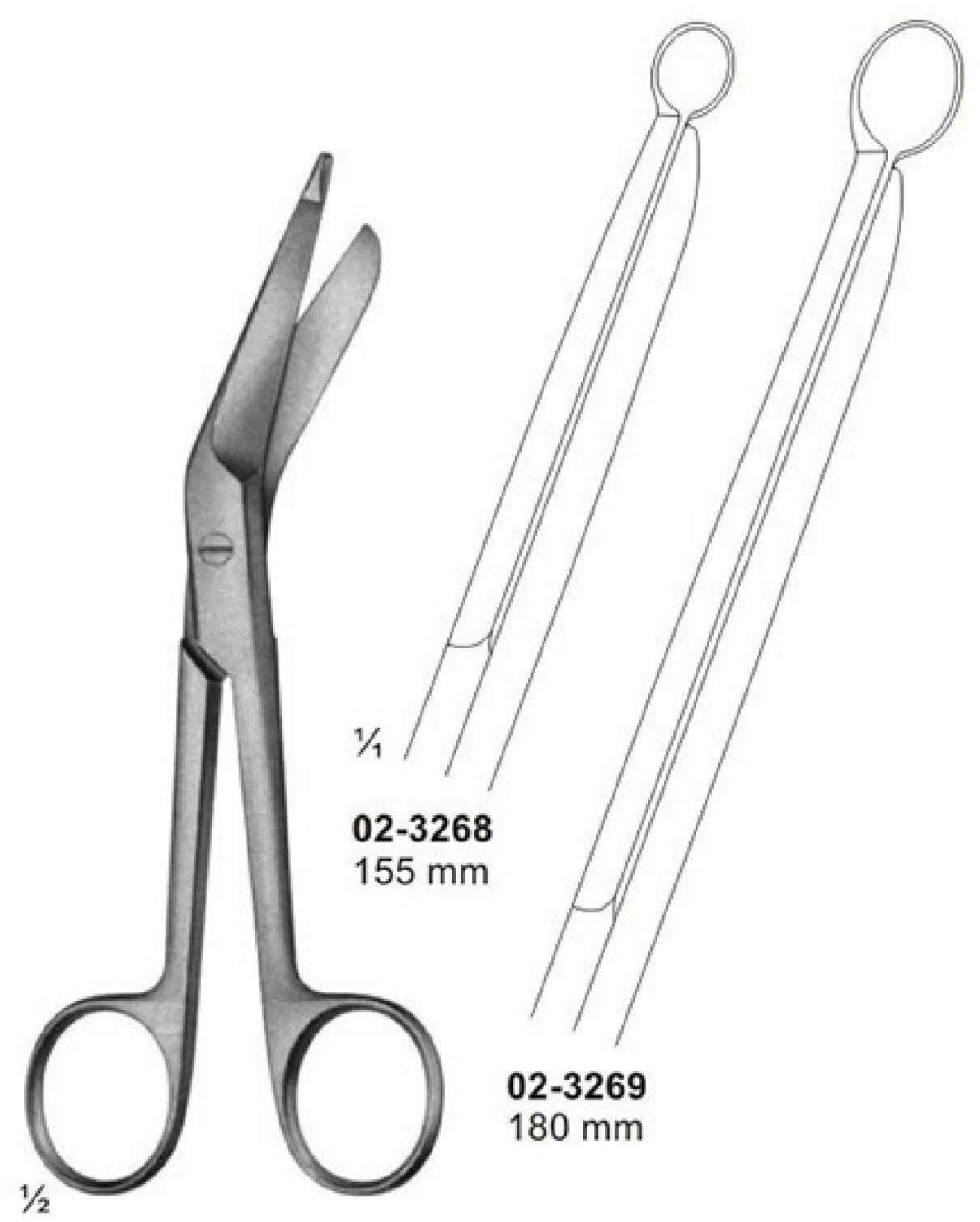

$\frac{1}{2}$
02-3268 - 02-3269
 LISTER

$\frac{1}{4}$
02-3268
 155 mm

02-3269
 180 mm

Bandage, Cloth and Plaster Scissors

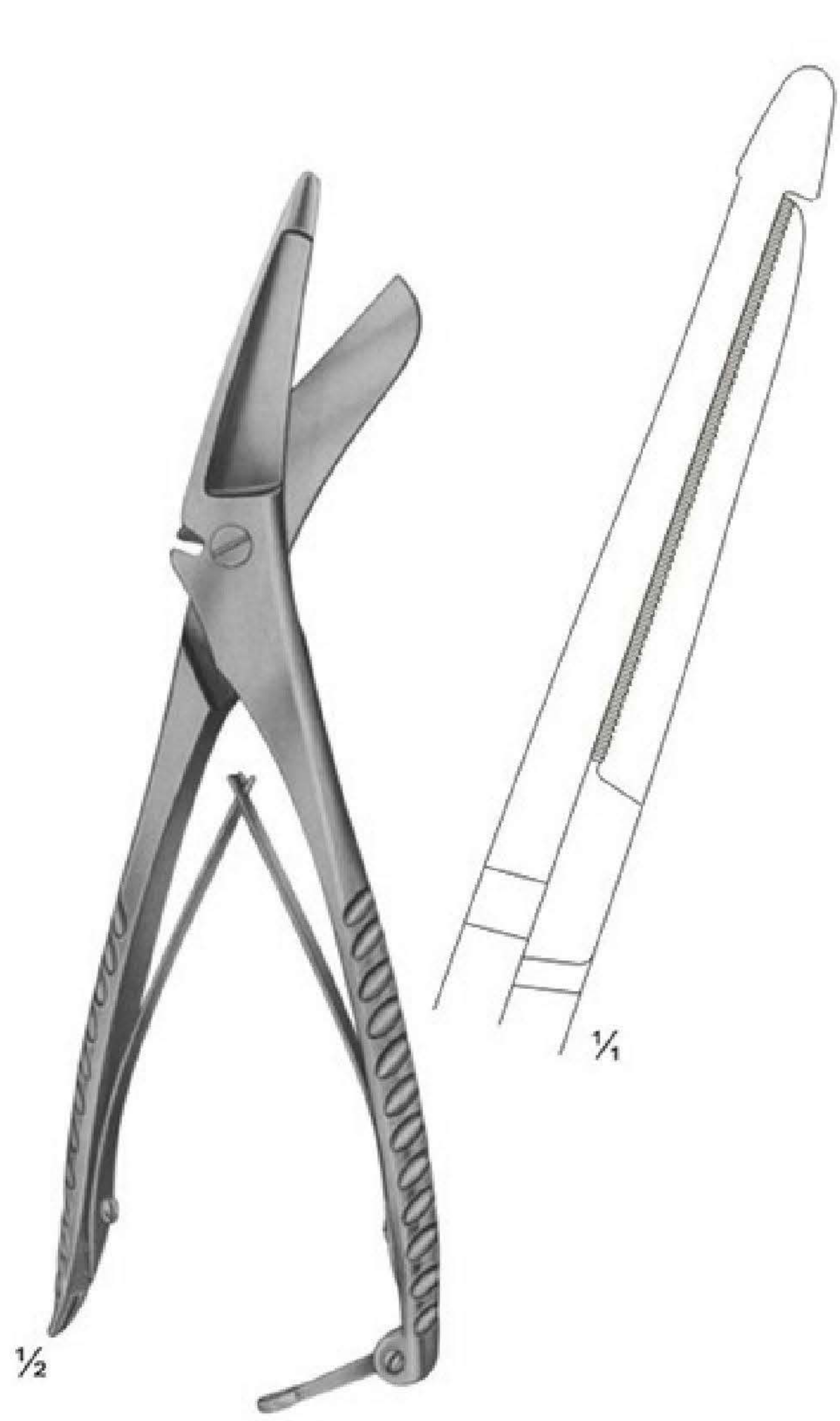

02-3270
 CLOTH SCISSORS
 205 mm

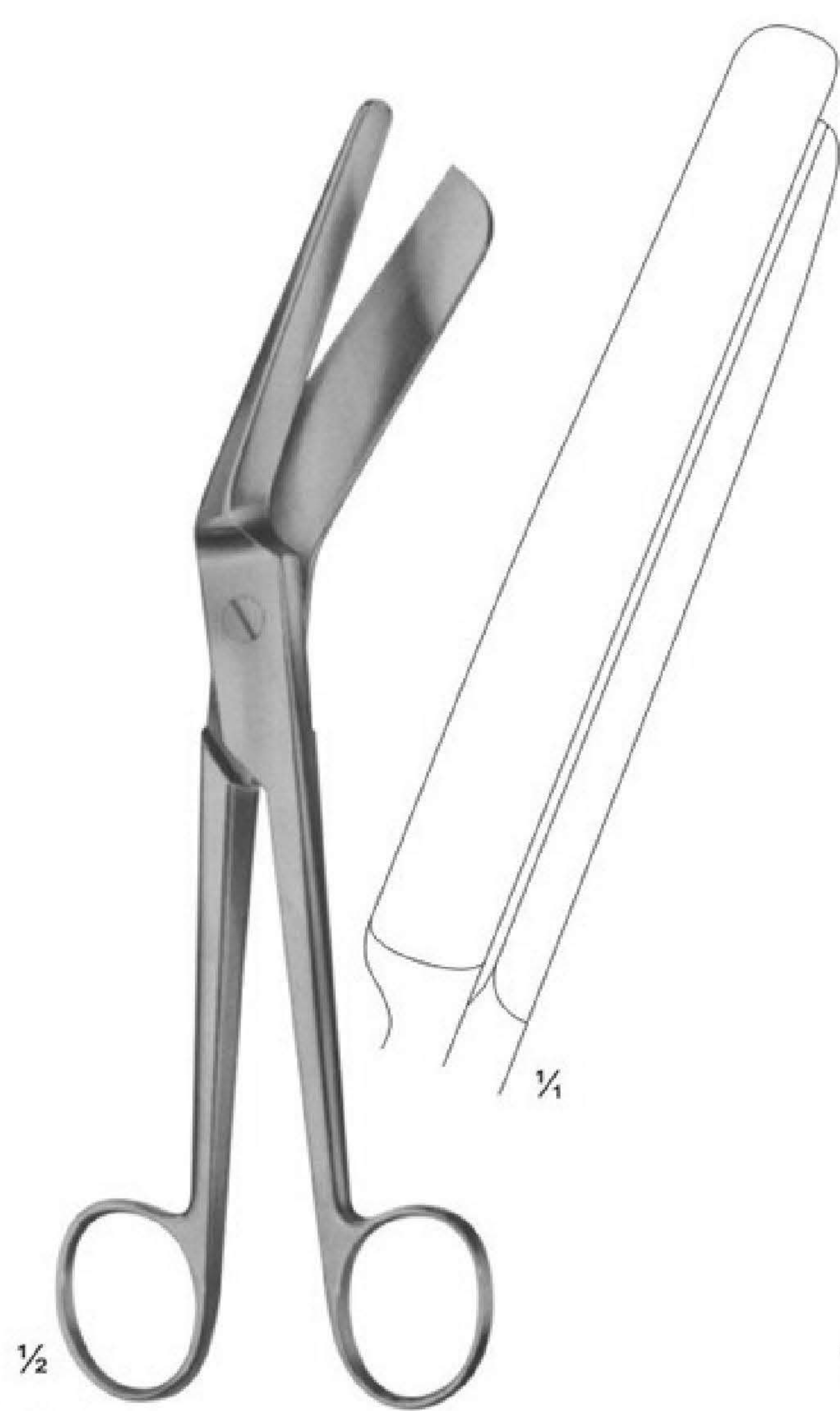

02-3271
 BRAUN-STADLER
 Bandage scissors
 225 mm



02-3272
 SEUTIN
 Plaster scissors
 230 mm

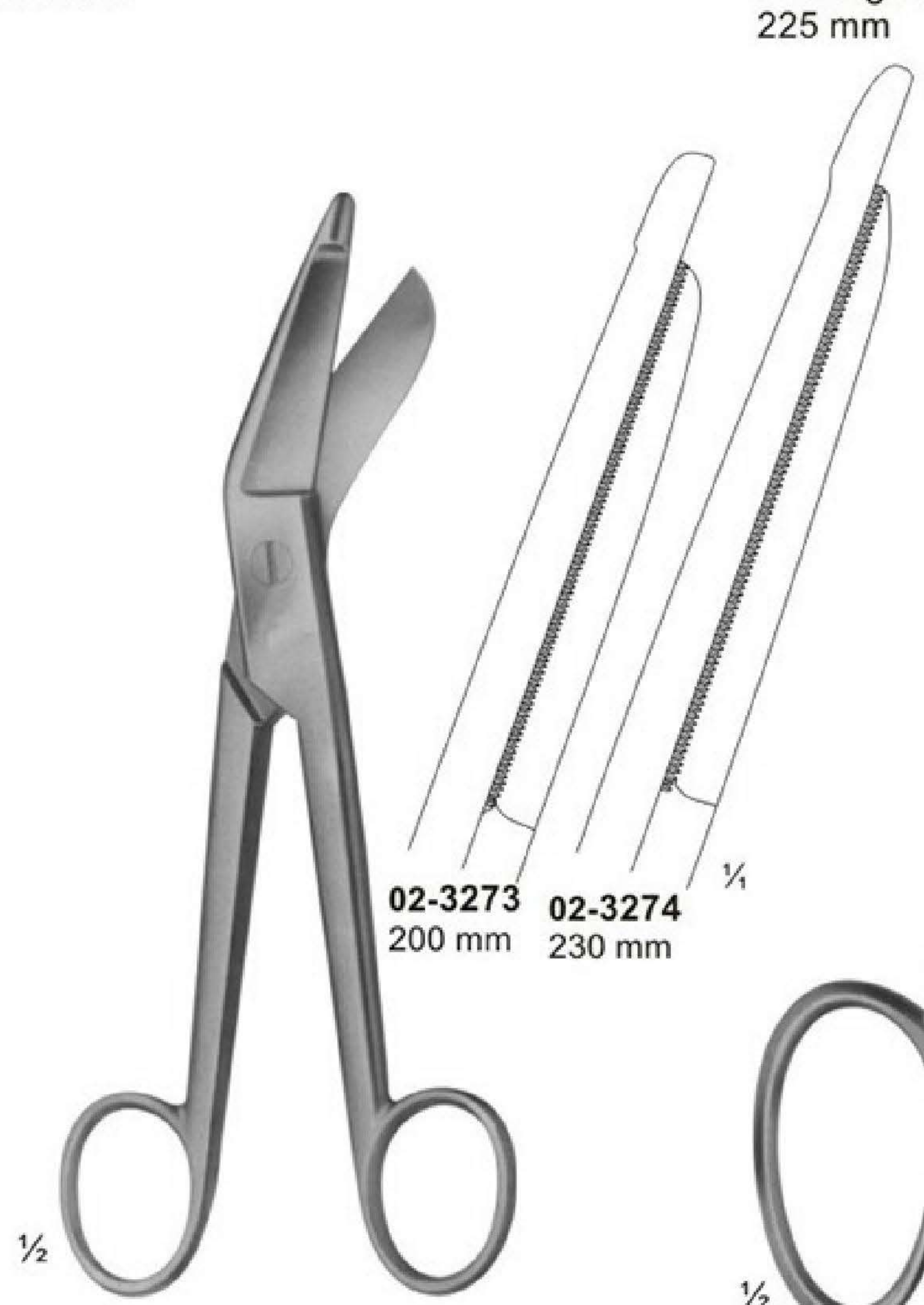

02-3273 200 mm
02-3274 230 mm

02-3273 - 02-3274
 ESMARCH (Plaster scissors)

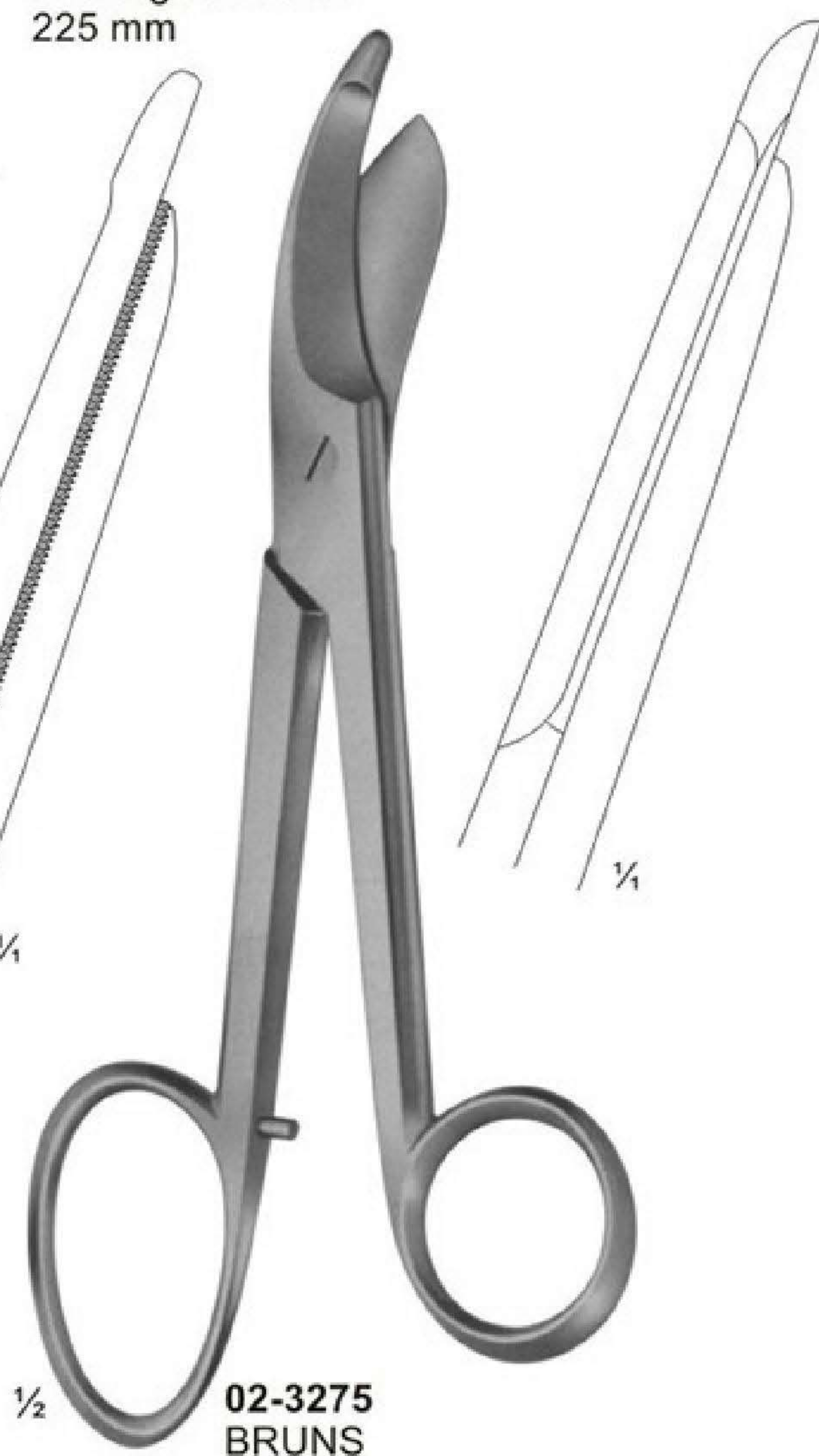

02-3275
 BRUNS
 Plaster scissors
 235 mm

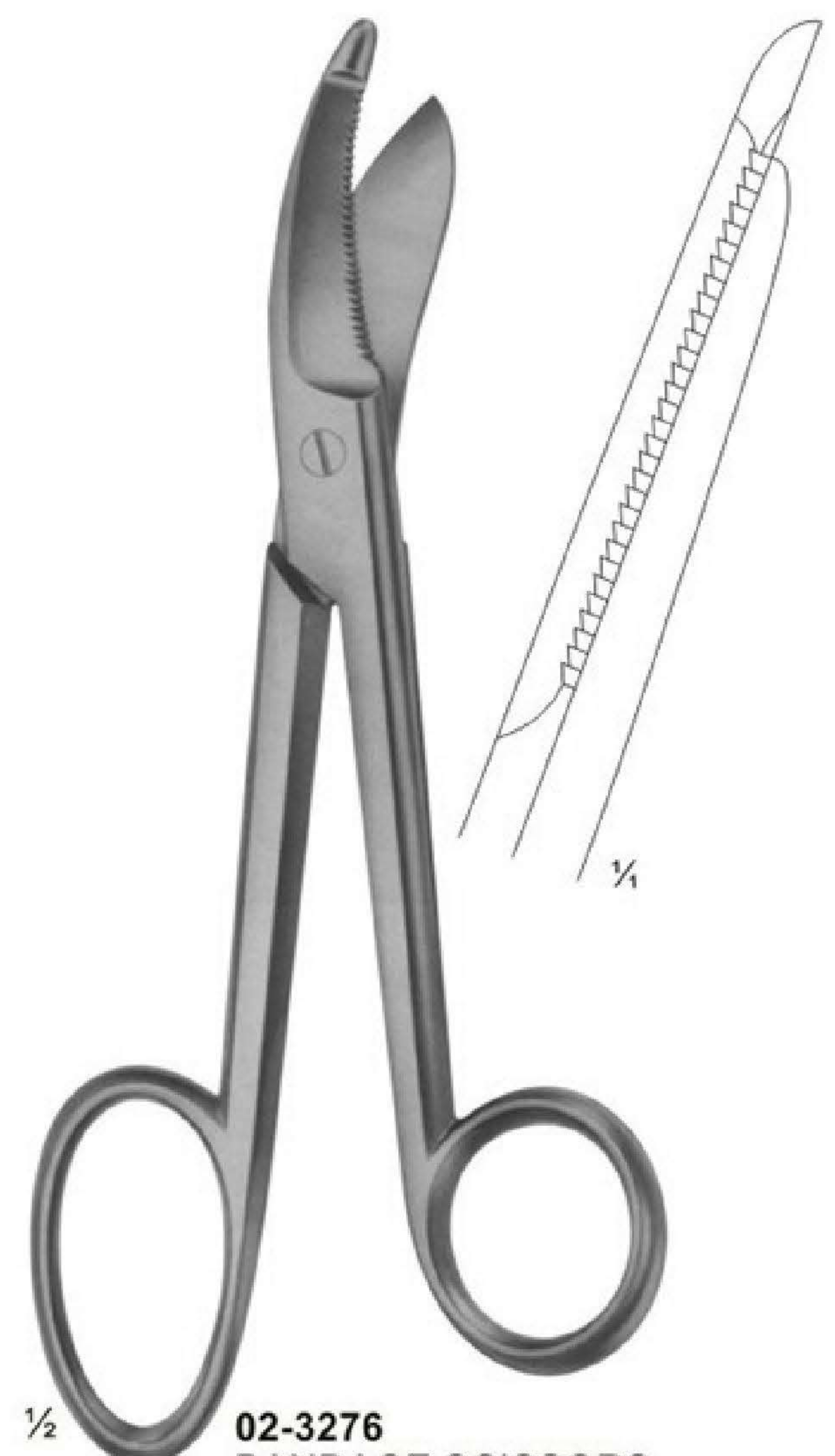

02-3276
 BANDAGE SCISSORS
 235 mm