

# Wire Extension

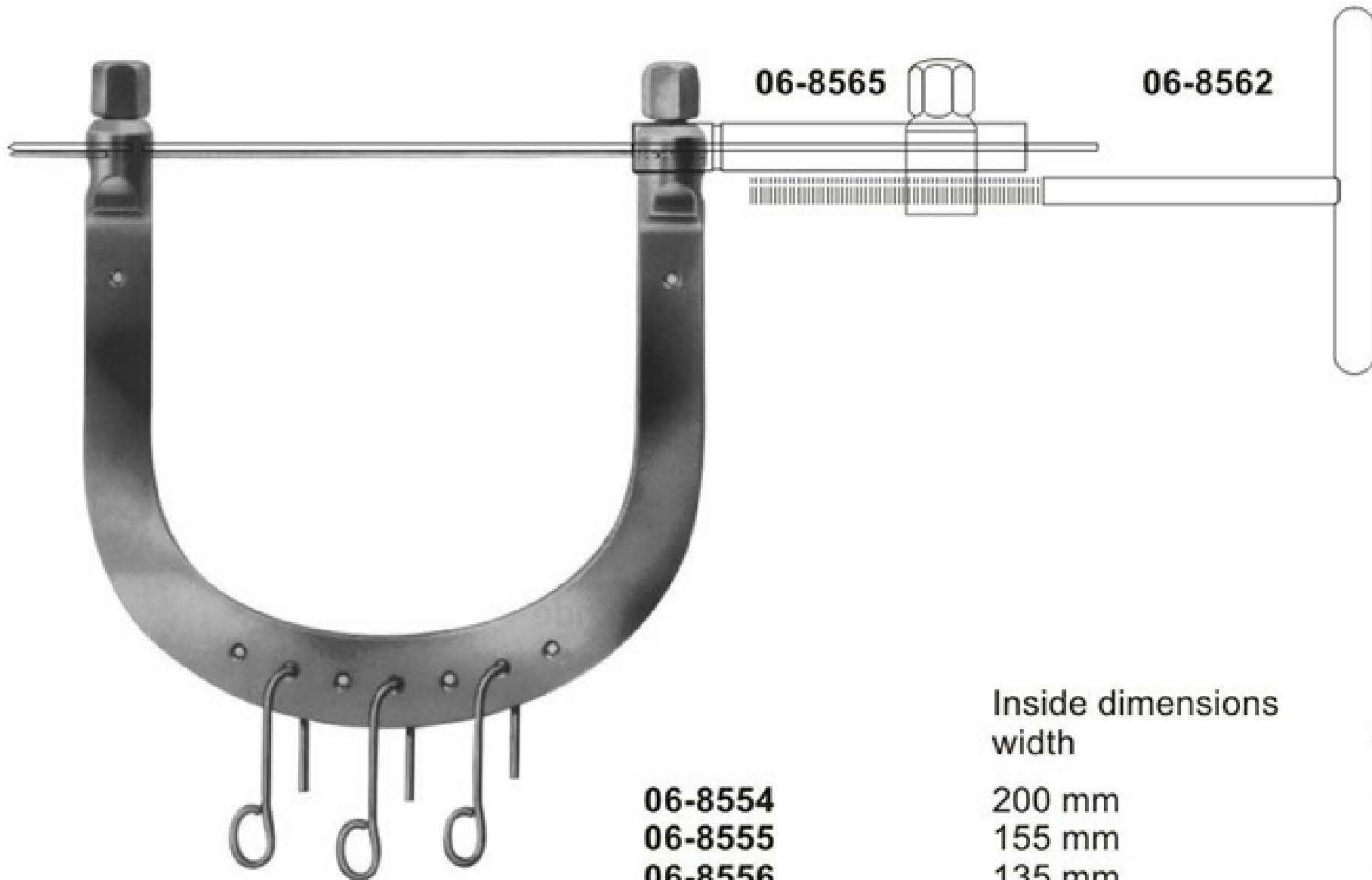

**06-8554 - 06-8560**  
 KIRSCHNER  
 Wire traction bows,  
 to be used with  
 KIRSCHNER-wires  
 up to 2.5 mm diam.,  
 With 3 hooks,  
 stainless steel

**06-8554**  
**06-8555**  
**06-8556**  
**06-8557**  
**06-8558**  
**06-8559**  
**06-8560**

Inside dimensions  
 width

200 mm  
 155 mm  
 135 mm  
 120 mm  
 105 mm  
 95 mm  
 95 mm

depth

155 mm  
 155 mm  
 130 mm  
 120 mm  
 100 mm  
 110 mm  
 70 mm

for the hip  
 for the femur  
 for the knee  
 for the knee  
 for the knee  
 for the calcaneus  
 for the arm and elbow



**06-8561**  
 Wrench, double - ended,  
 for wire traction bows



**06-8562**  
 Wire tightener, with  
 clamping jaws



1/3

**06-8563**  
 Traction hook only,  
 large size



1/3

**06-8564**  
 Traction hook only,  
 small size



1/3

**06-8565**  
 Fixation clamp, to secure clamping  
 jaws of **06-8562** stainless steel

# Wire Extension

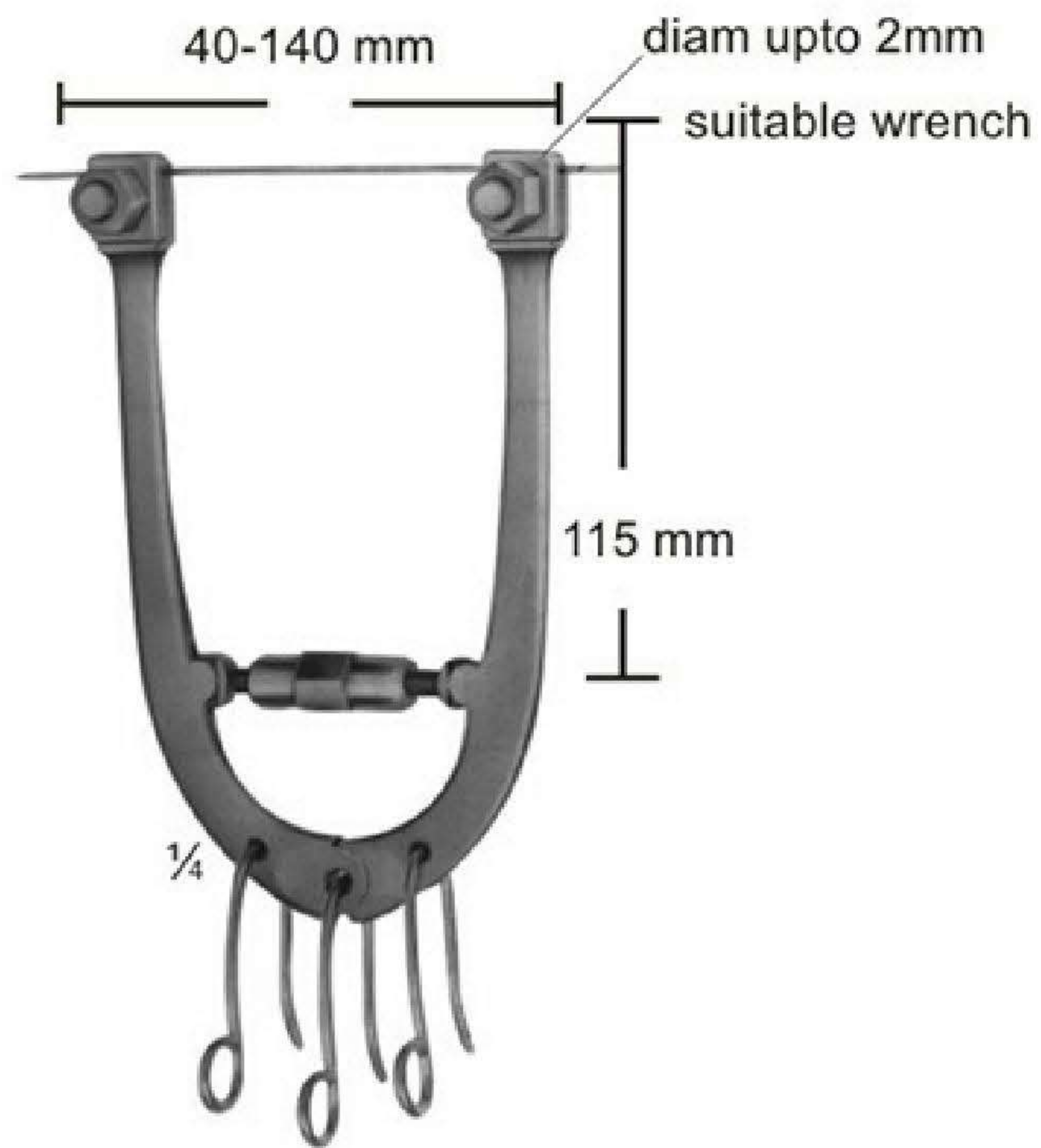

**06-8566**  
Wire traction bow, adjustable,  
with 3 hooks, small size

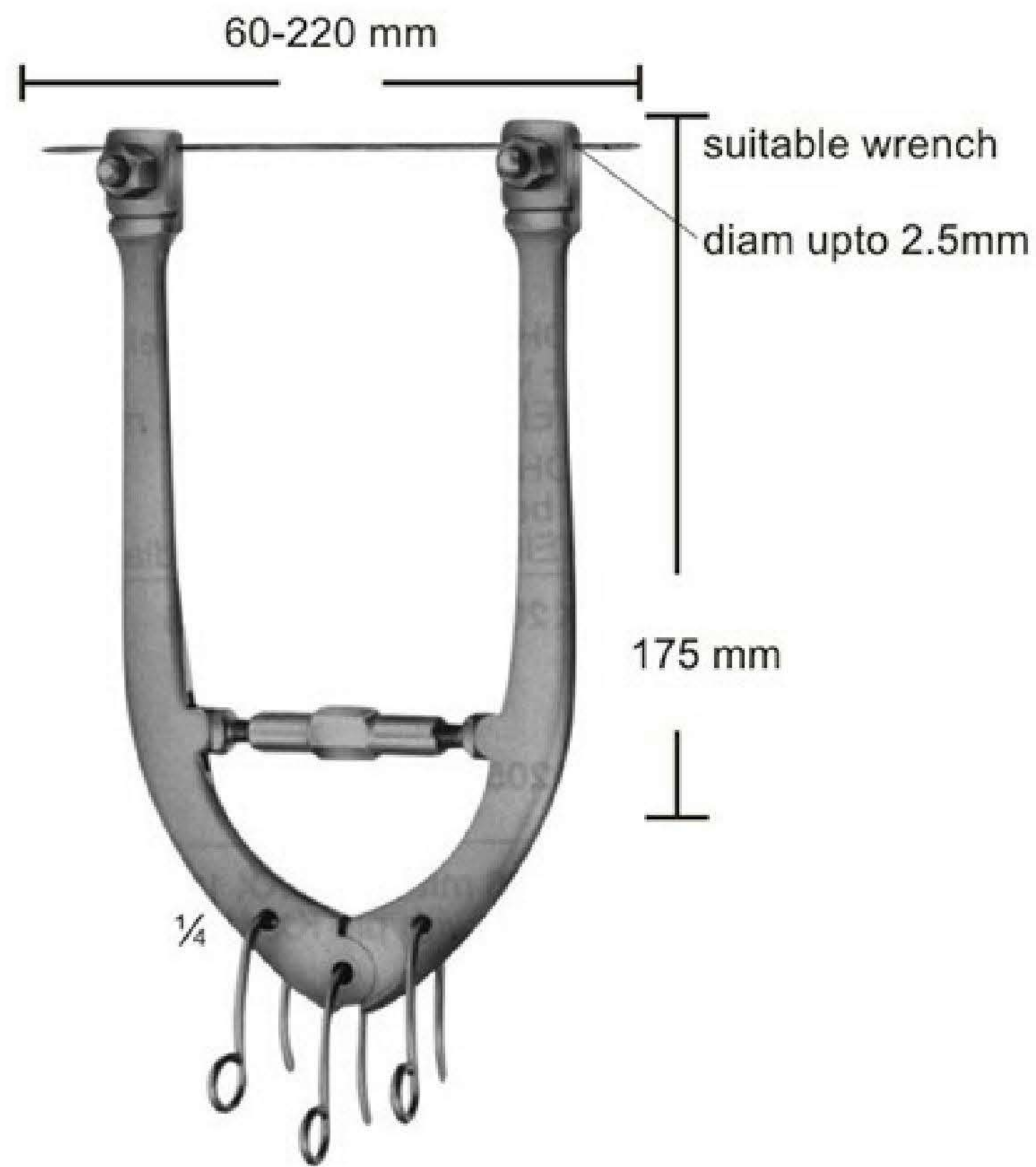

**06-8567**  
Wire traction bow, adjustable,  
with 3 hooks, large size

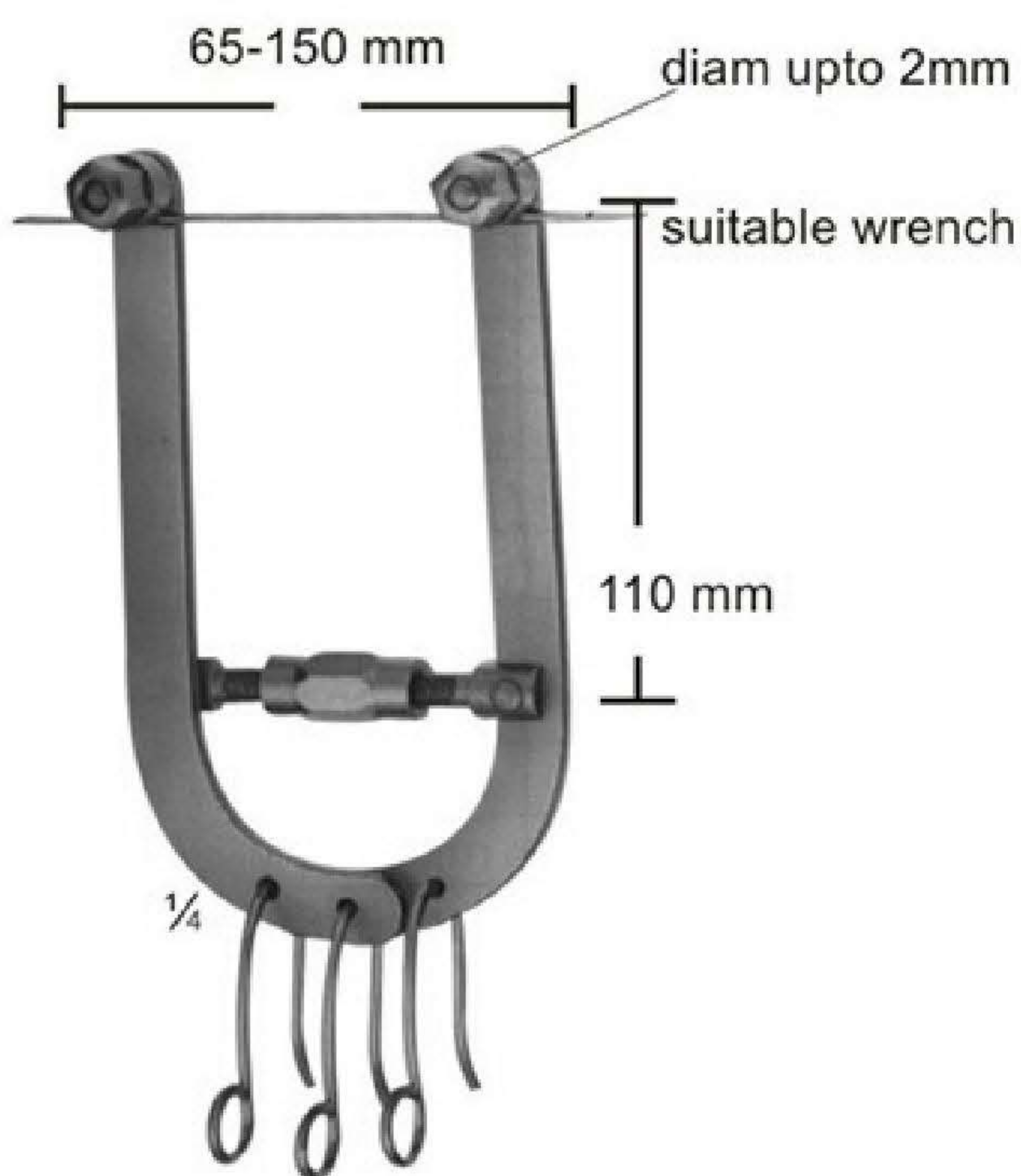

**06-8568**  
Wire traction bow, adjustable,  
with 3 hooks, small size for  
elbow and calcaneus, for  
adolescents

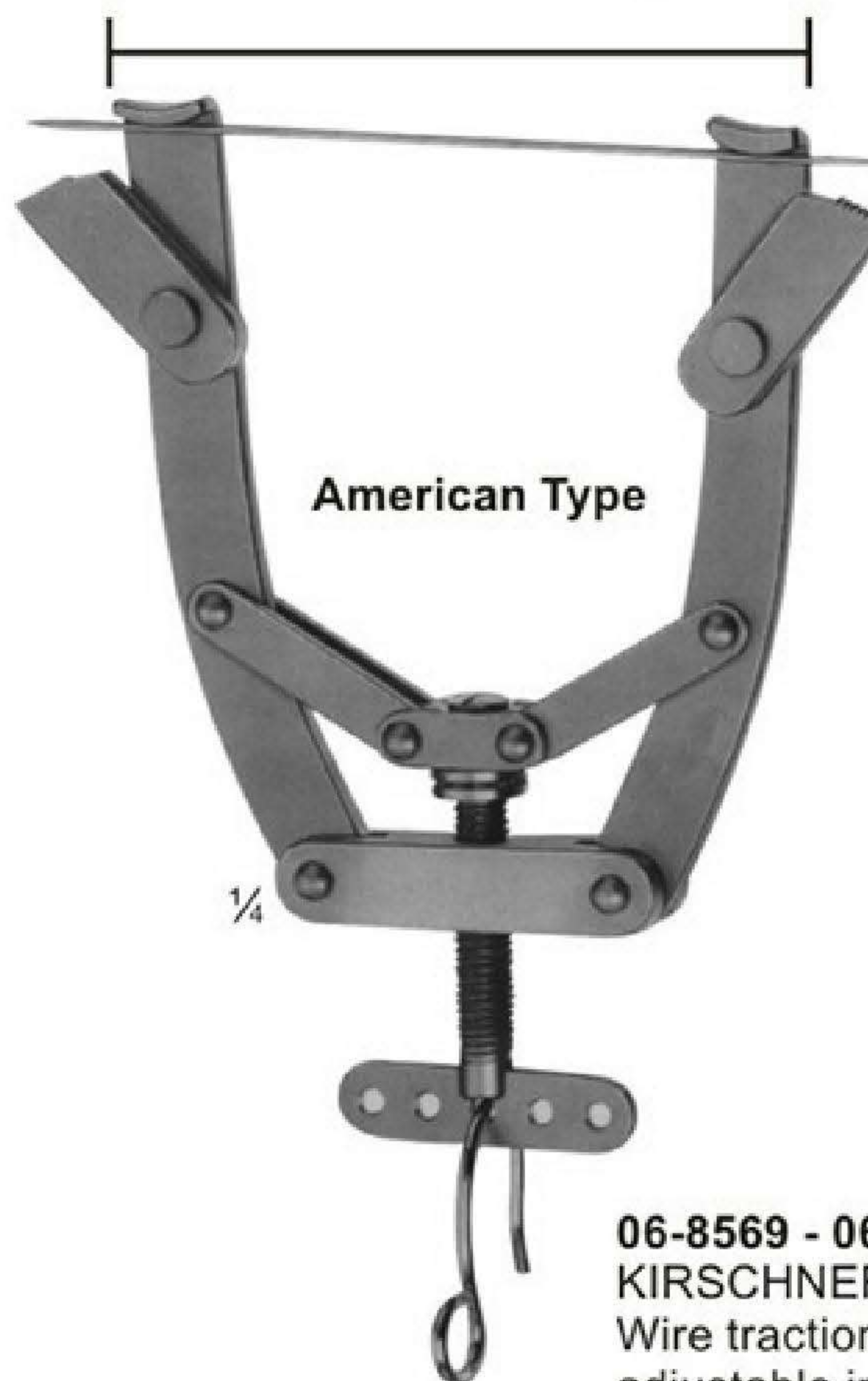

**06-8569** max. 105 mm  
**06-8570** max. 160 mm  
**06-8571** max. 200 mm

**06-8569** 80-95 mm  
**06-8570** 90-120 mm  
**06-8571** 140-170 mm

diam upto  
**06-8569** 1,6 mm  
**06-8570** 2,0 mm  
**06-8571** 2,5 mm

**06-8569 - 06-8571**  
**KIRSCHNER**  
Wire traction bows, modified,  
adjustable in width, holds wire  
securely, with 1 hook



**06-8572**  
Fixation disc, slotted



**06-8574**  
Fixation disc, slotted



**06-8573**  
idem, aluminum, transparent  
to X-rays



**06-8575**  
Screw driver, for above  
fixations discs

# Traction Bows, Distractor



Boehler traction bows, to be used with STEINMANN pins, 4mm diam	Boehler traction bows, to be used with STEINMANN pins, 5mm diam	Inside width	For
<b>06-8576</b> with pin ( <b>09-8588</b> )		16x9cm	Arm
<b>06-8577</b> without pin	<b>06-8582</b> without pin		
<b>06-8578</b> with pin ( <b>09-8590</b> )		21x11cm	Femur and knee
<b>06-8579</b> without pin	<b>06-8583</b> without pin		
<b>06-8580</b> with pin ( <b>09-8592</b> ) <b>06-8581</b> without pin		21x15cm	Femur and knee



**06-8584 - 06-8598**  
STEINMANN  
triangular shaft ended and trocar point

diam $\phi$	4,0 mm	5,0 mm
Length		
80 mm	<b>06-8584</b>	
100 mm	<b>06-8585</b>	
120 mm	<b>06-8586</b>	
140 mm	<b>06-8587</b>	
150 mm	<b>06-8588</b>	<b>06-8594</b>
160 mm	<b>06-8589</b>	
180 mm	<b>06-8590</b>	<b>06-8595</b>
200 mm	<b>06-8591</b>	<b>06-8596</b>
210 mm	<b>06-8592</b>	
250 mm	<b>06-8593</b>	<b>06-8597</b>
300 mm		<b>06-8598</b>



**06-8599**  
SCHWARZ  
Traction bow for fingers,  
to be used with KIRSCHNER-  
wire up to 1.6 mm diam.

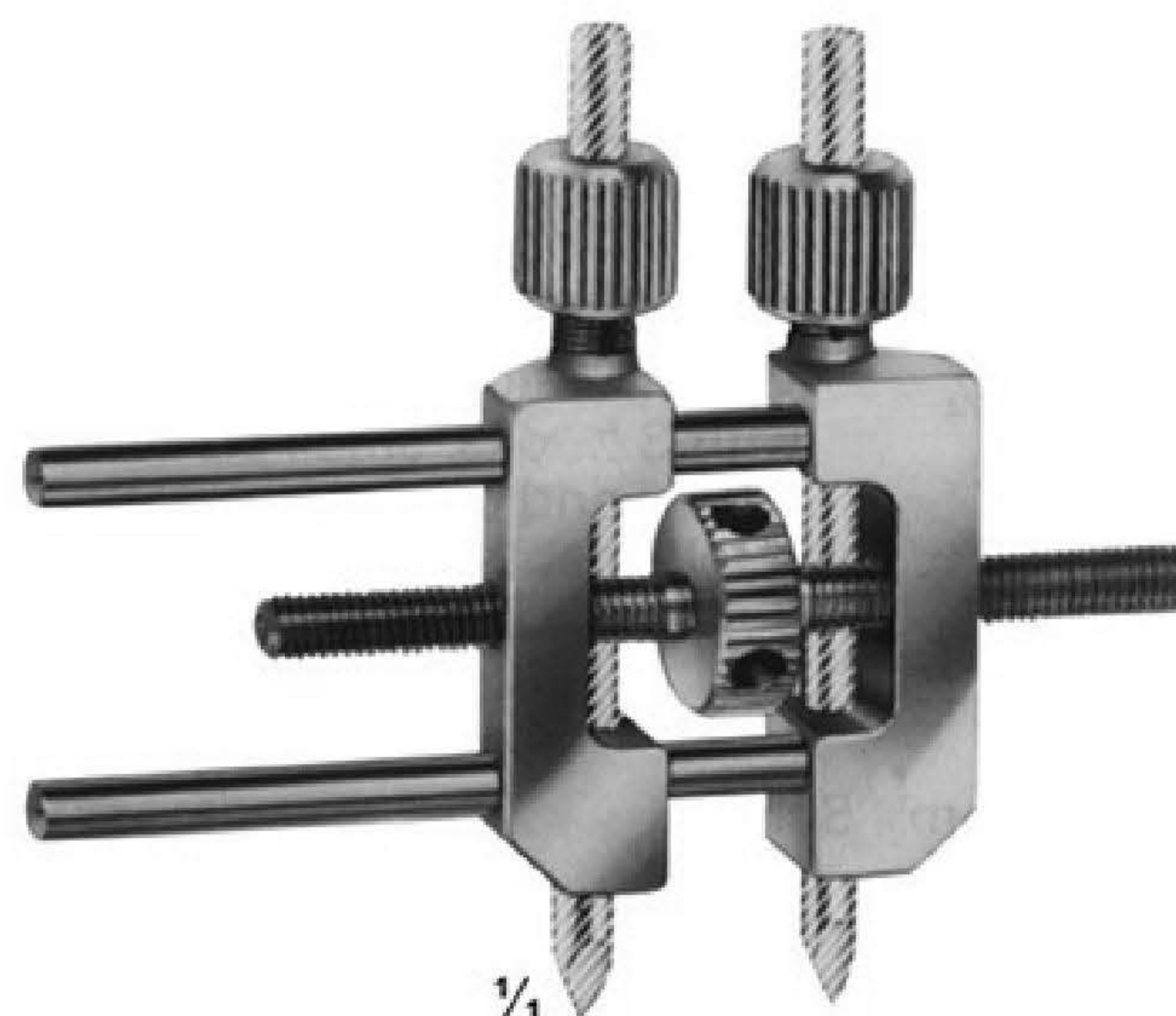

**06-8600**  
Small distractor  
as a repositioning device for  
distraction and compression of small bones,  
for wires with 3.0 mm diam.

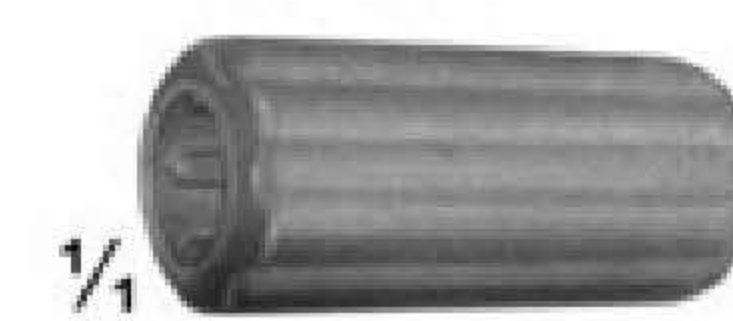

**06-8601**  
Protection cap  
for 4,0 mm STEINMANN Pins



**06-8602**  
Protection cap  
for 5,0 mm STEINMANN Pins

# Drilling Chucks and Cerclage Wire Tightener



1/2

**06-8603**  
REILL  
Drilling chuck, cannulated, for shanks from 2.0 - 2.5 mm diam 115 mm

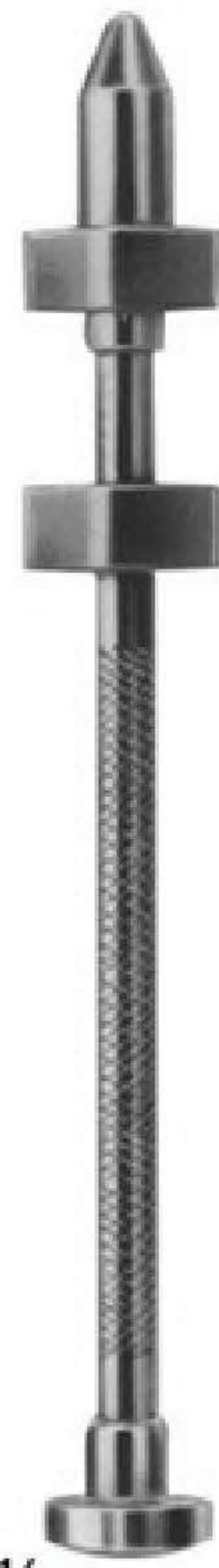

1/2

**06-8604**  
Drilling chuck, cannulated, for shanks from 0.8 - 2.0 mm diam 150 mm



1/2

**06-8605**  
Drilling chuck, cannulated, for shanks up to 4.5 mm diam with key 140 mm

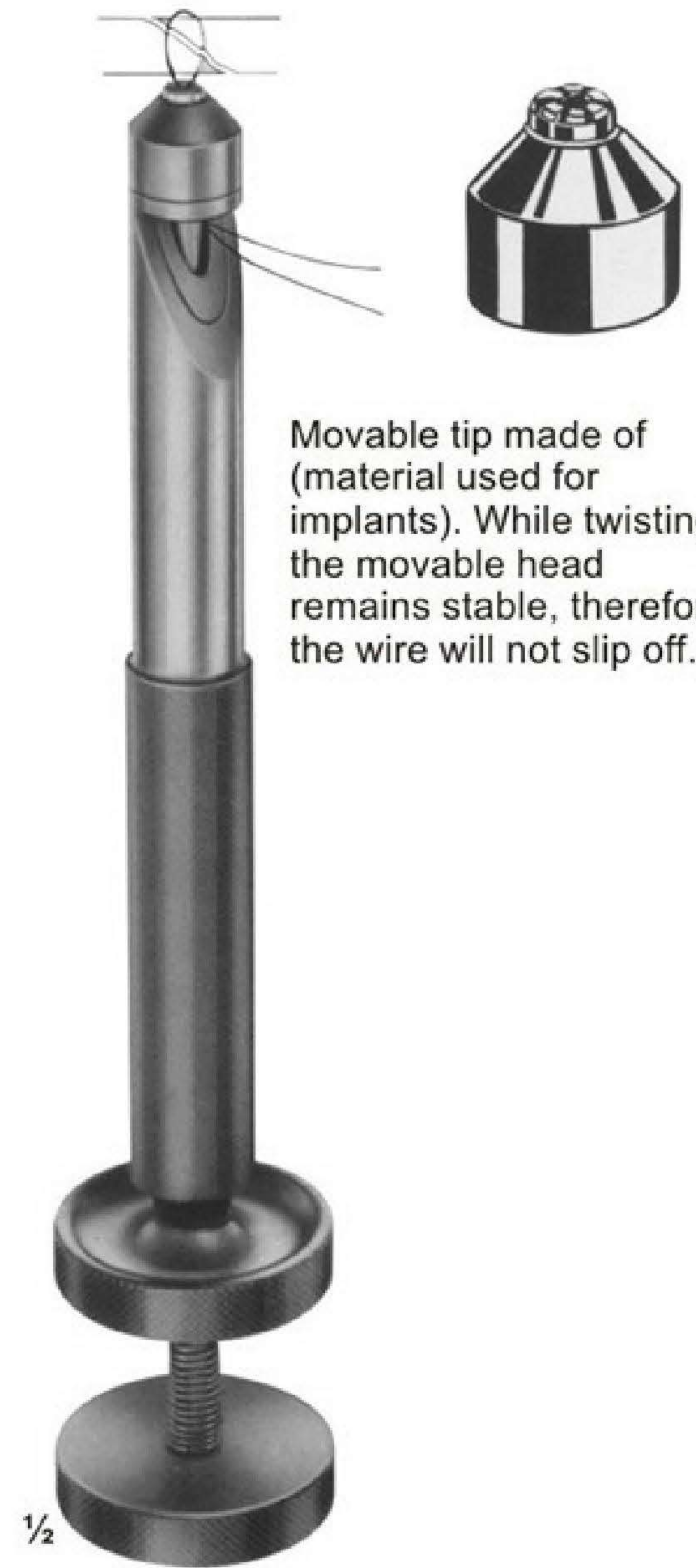

1/2

**06-8606**  
LOUTE  
Wire tightener, improved pattern, with movable tip, for wires up to 1.0 mm diam. 220 mm

Movable tip made of (material used for implants). While twisting the movable head remains stable, therefore the wire will not slip off.

Chuck jaws made of material used for implants



1/2

**06-8607**  
Drilling chuck, cannulated, for shanks up to 6.35 mm diam., To be tightened by hand 100 mm



1/2

**06-8608**  
Drilling chuck, cannulated, for shanks up to 4.5 mm diam., And for triangular shaft width across flats 4.7 mm (schanz screws, steinmann pins). with key **06-8609**

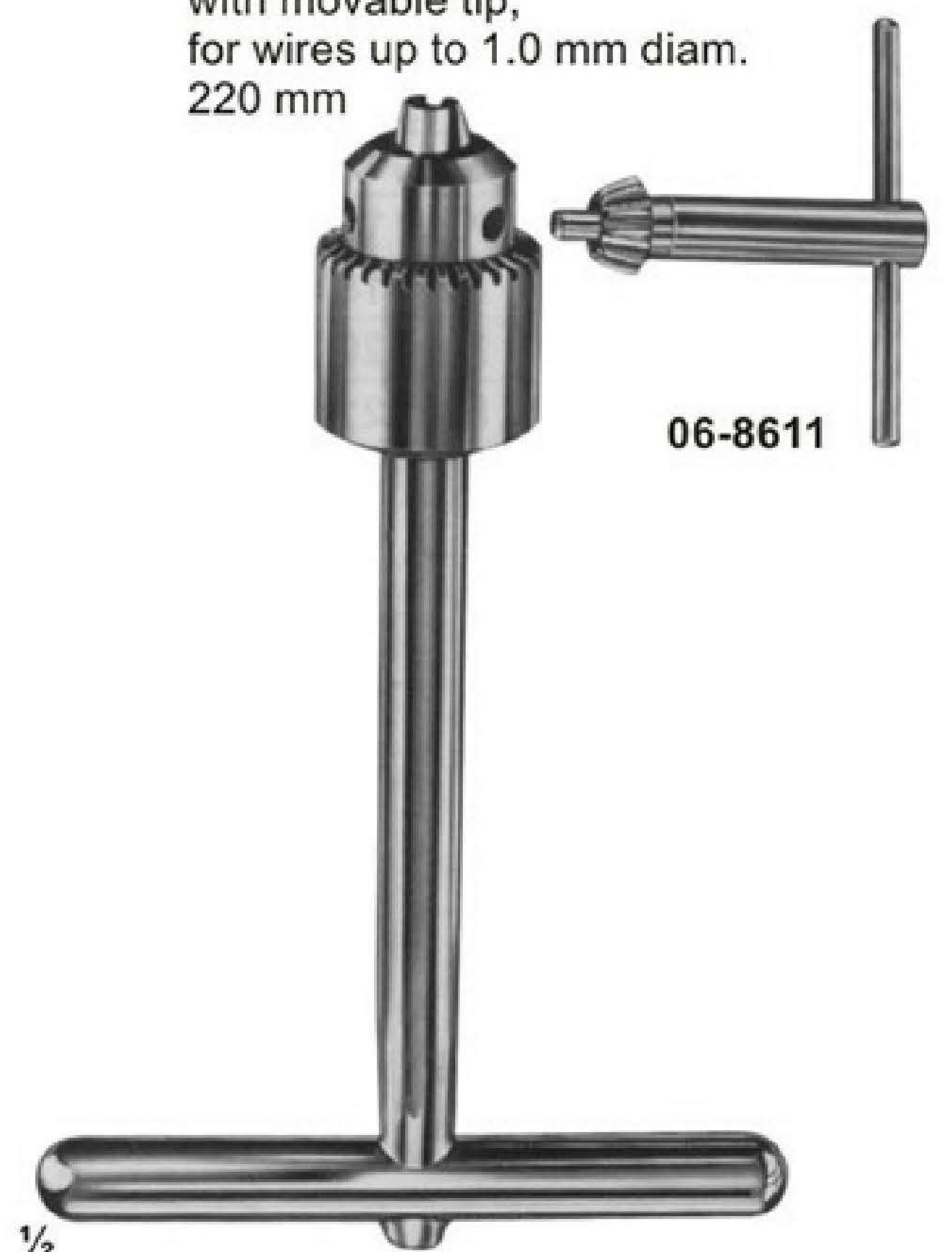

1/2

**06-8610**  
Drilling chuck, cannulated, for shanks up to 6.35 mm diam., With key (**06-8611**) 160 mm

# Cerclage Instruments

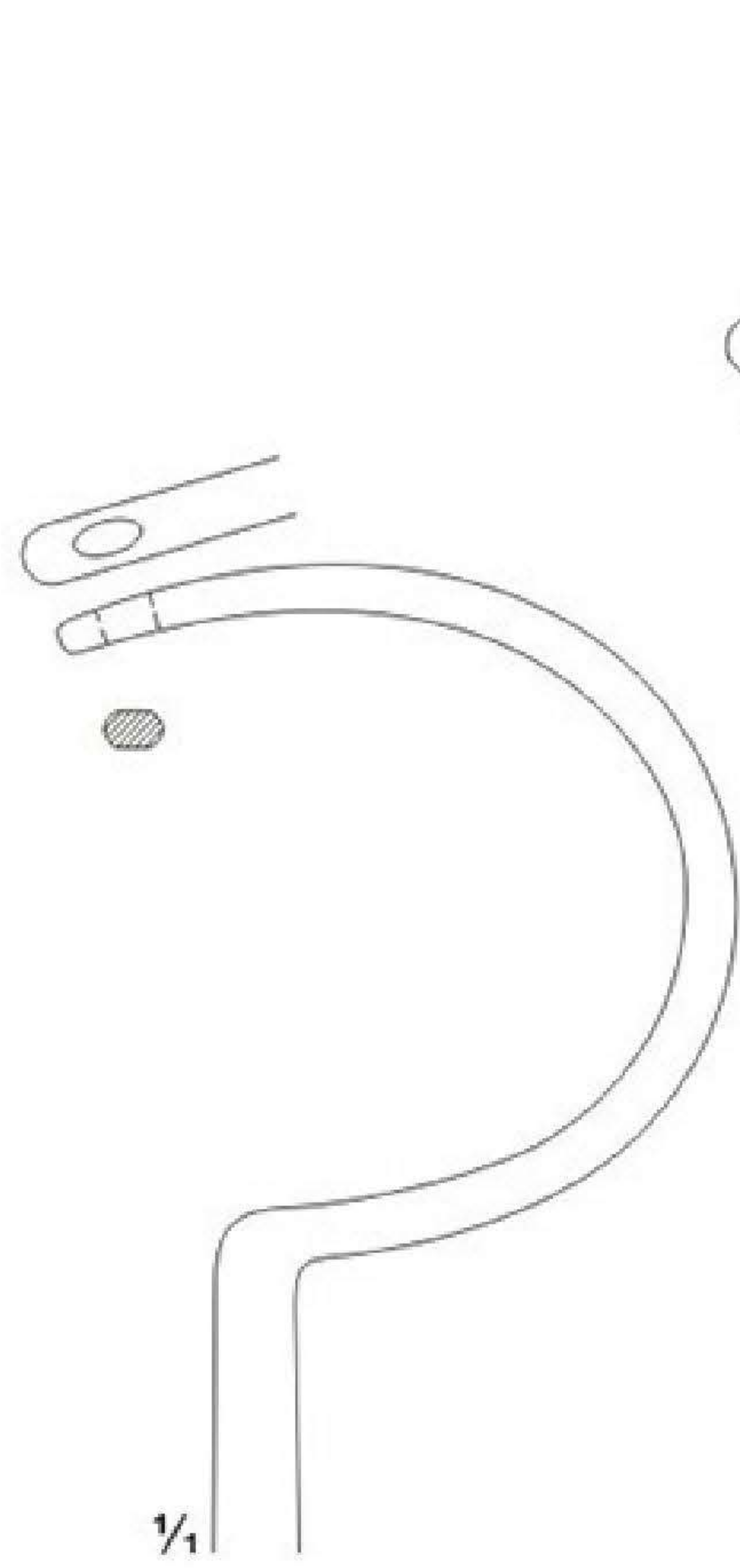

**06-8612**  
 275 mm

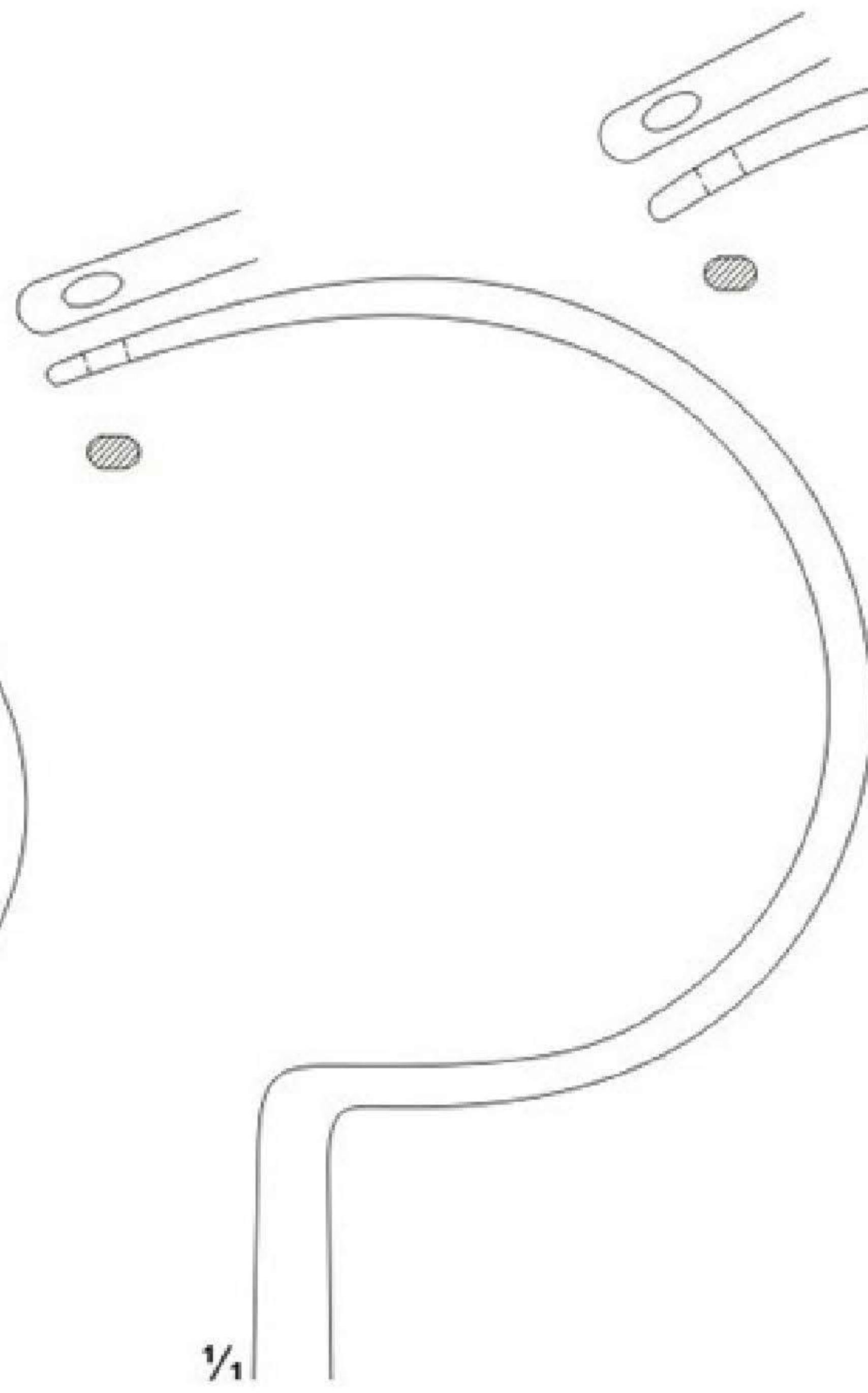

**06-8613**  
 285 mm

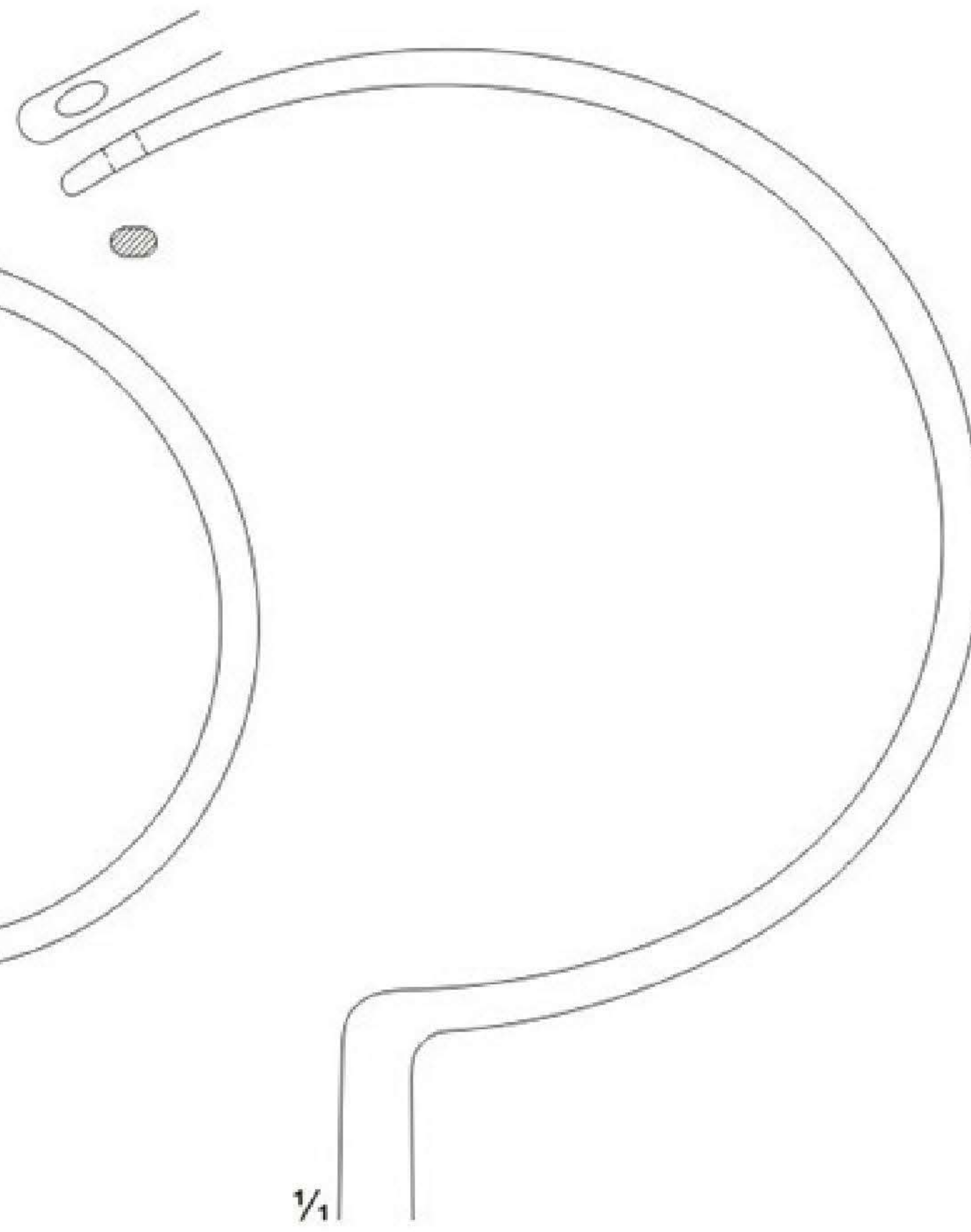

**06-8614**  
 305 mm

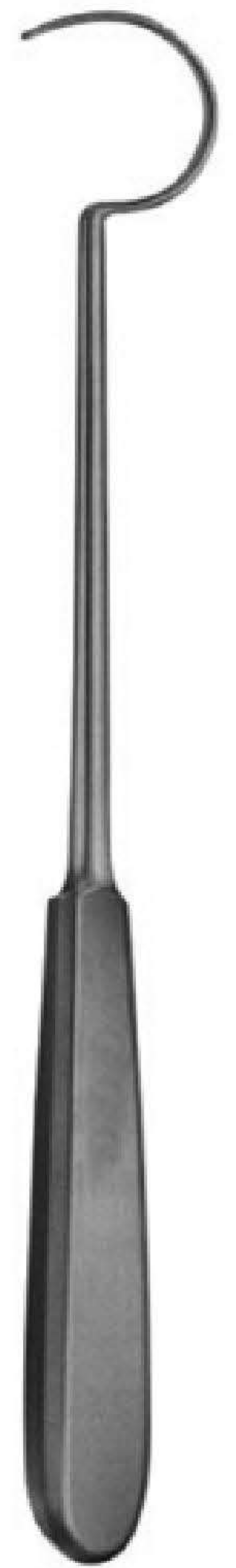

**06-8612 - 06-8614**  
 DEMEL  
 Wire guides

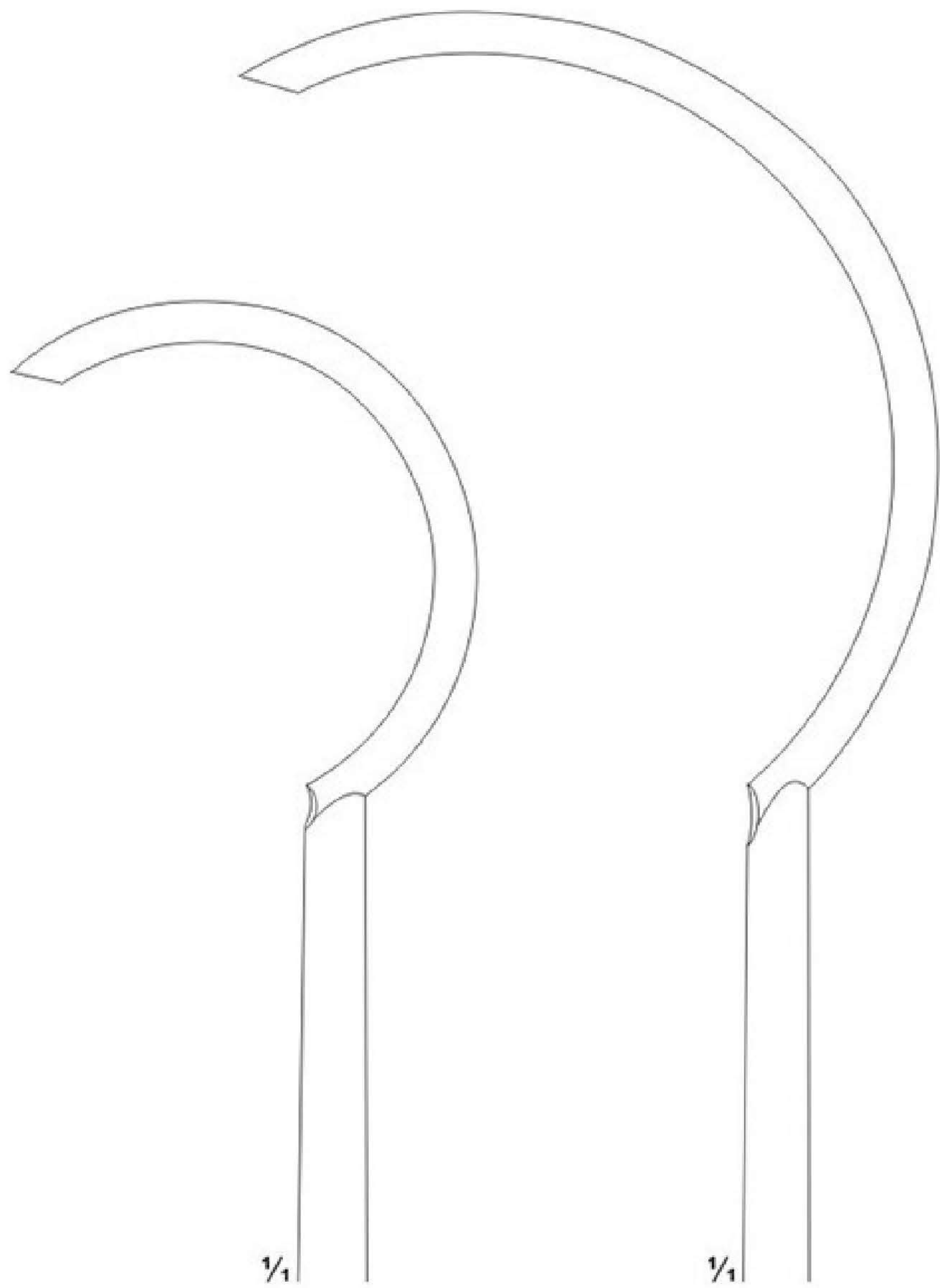

**06-8615**  
 240 mm



**06-8616**  
 270 mm

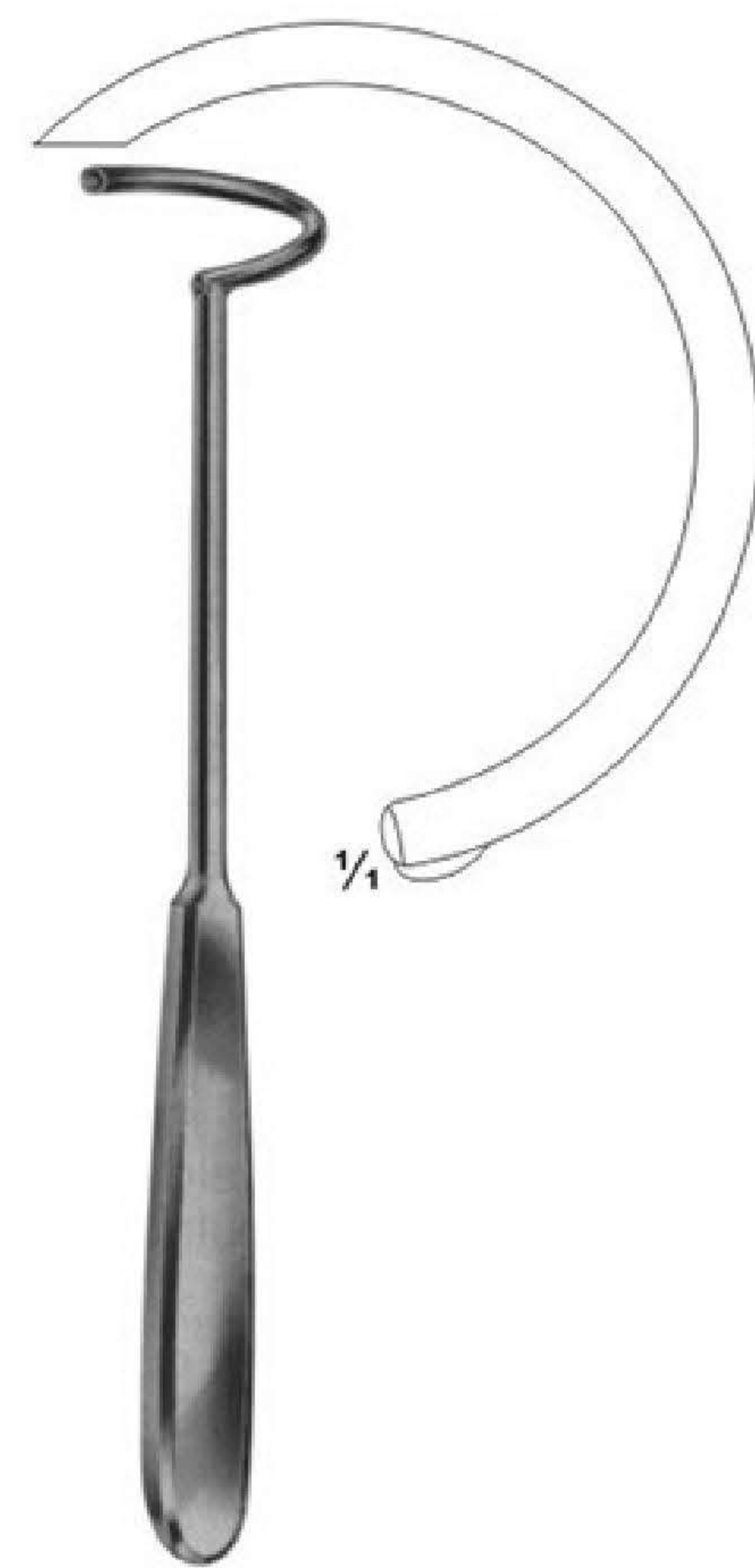

**06-8617**  
 225 mm

# JORDAN instruments for subcutaneous Tibia Cerclage

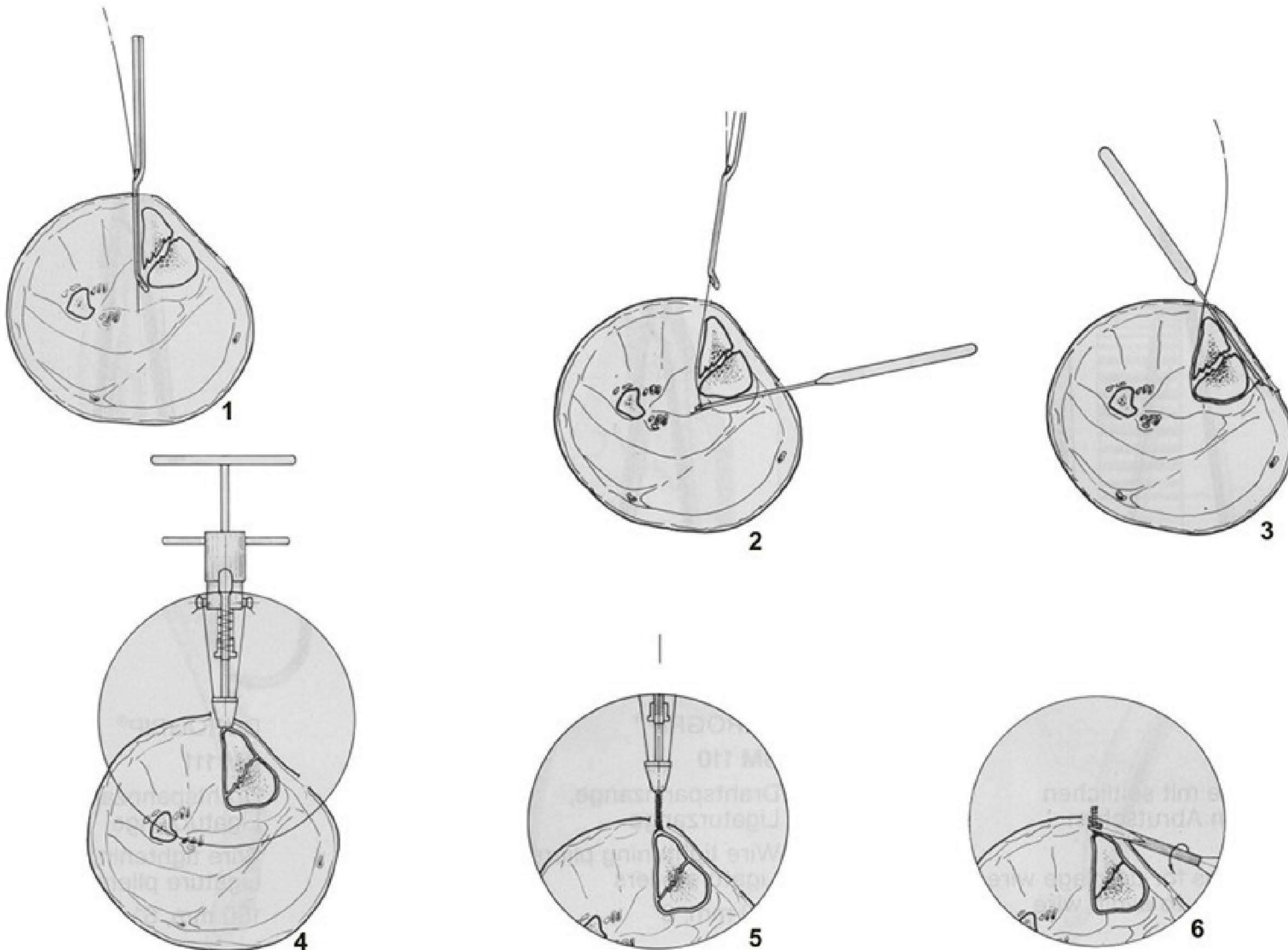

**06-8618**  
JORDAN  
Wire tightener



1/2

**06-8619**  
JORDAN  
Wire twister  
170 mm



1/2

**06-8620**  
JORDAN  
Wire catcher  
180 mm



1/2

**06-8621**  
JORDAN  
Probe, cannulated  
170 mm

# Wire Holding forceps, Wire Tightening Pliers, Flat-nosed Pliers DUROGRIP with Hard Metal Inserts

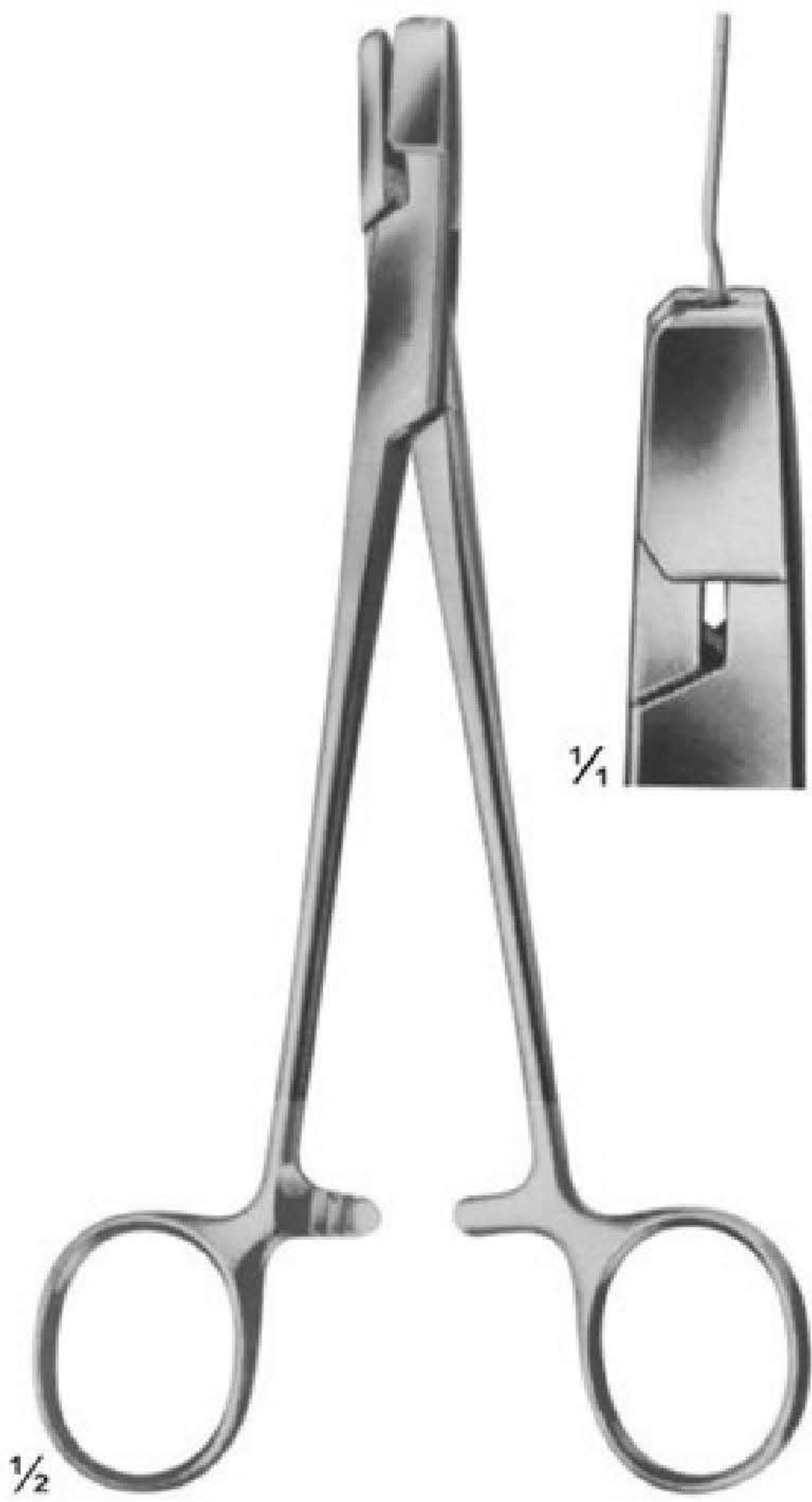

**06-8622**  
DUROGRIP  
Holding forceps for cerclage wire, with lateral jaws to avoid wire slipping off  
170 mm



**06-8623**  
DUROGRIP  
Wire, tightening pliers, Ligature pliers  
150 mm



**06-8624**  
DUROGRIP  
Wire, tightening pliers, Ligature pliers  
150 mm



**06-8625**  
with serrated jaws  
140 mm



**06-8626**  
one jaw smooth, one jaw serrated  
140 mm



**06-8627**  
with serrated jaws  
**06-8628**  
with longitudinal and transversal grooves  
170 mm



**06-8629**  
190 mm

Wire Holding forceps, Flat-nosed Pliers,  
Pliers for bending and cutting wires

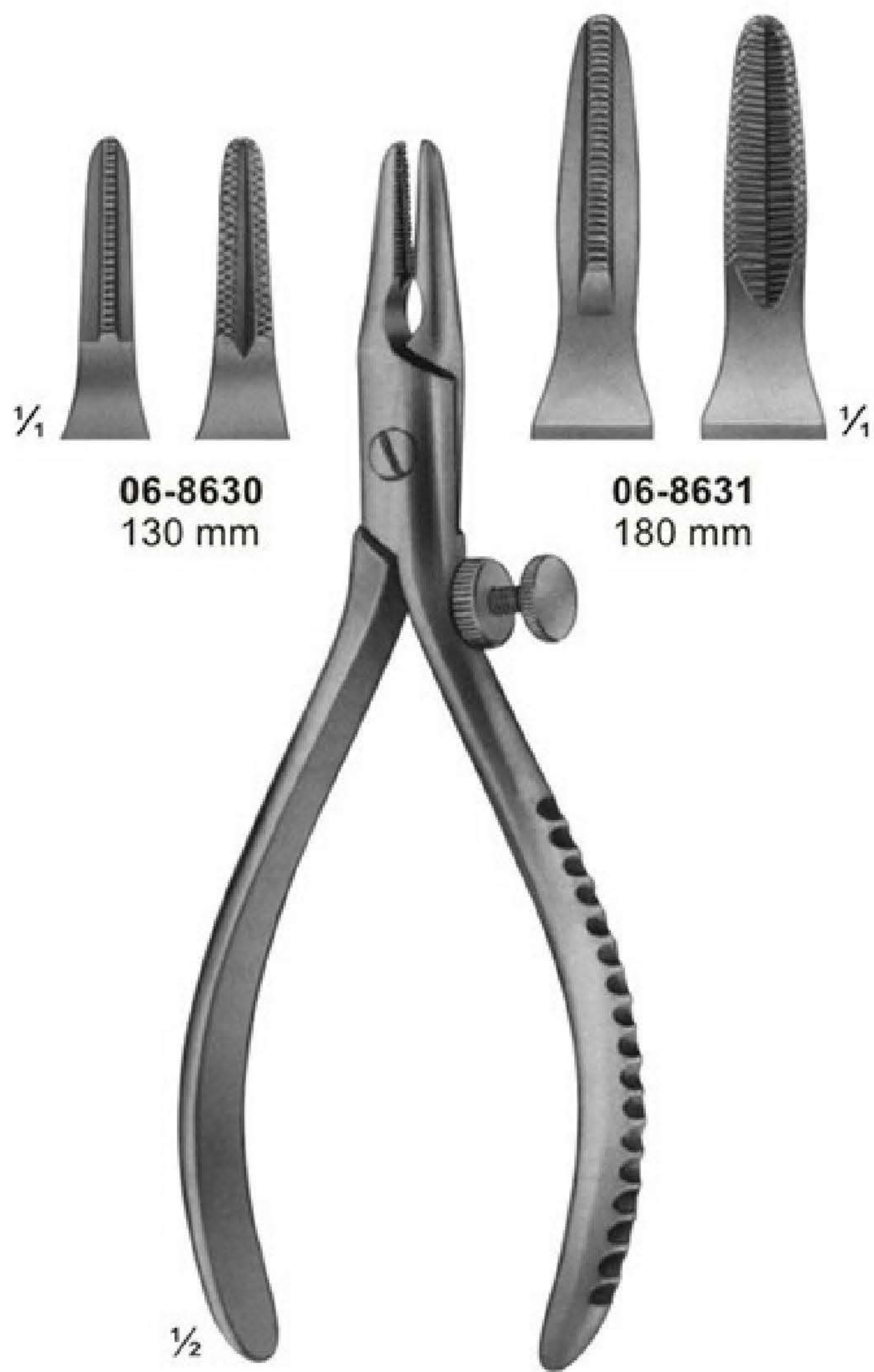

**06-8630**  
130 mm

**06-8631**  
180 mm

**06-8630 - 06-8631**  
Extraction pliers  
for boring wires

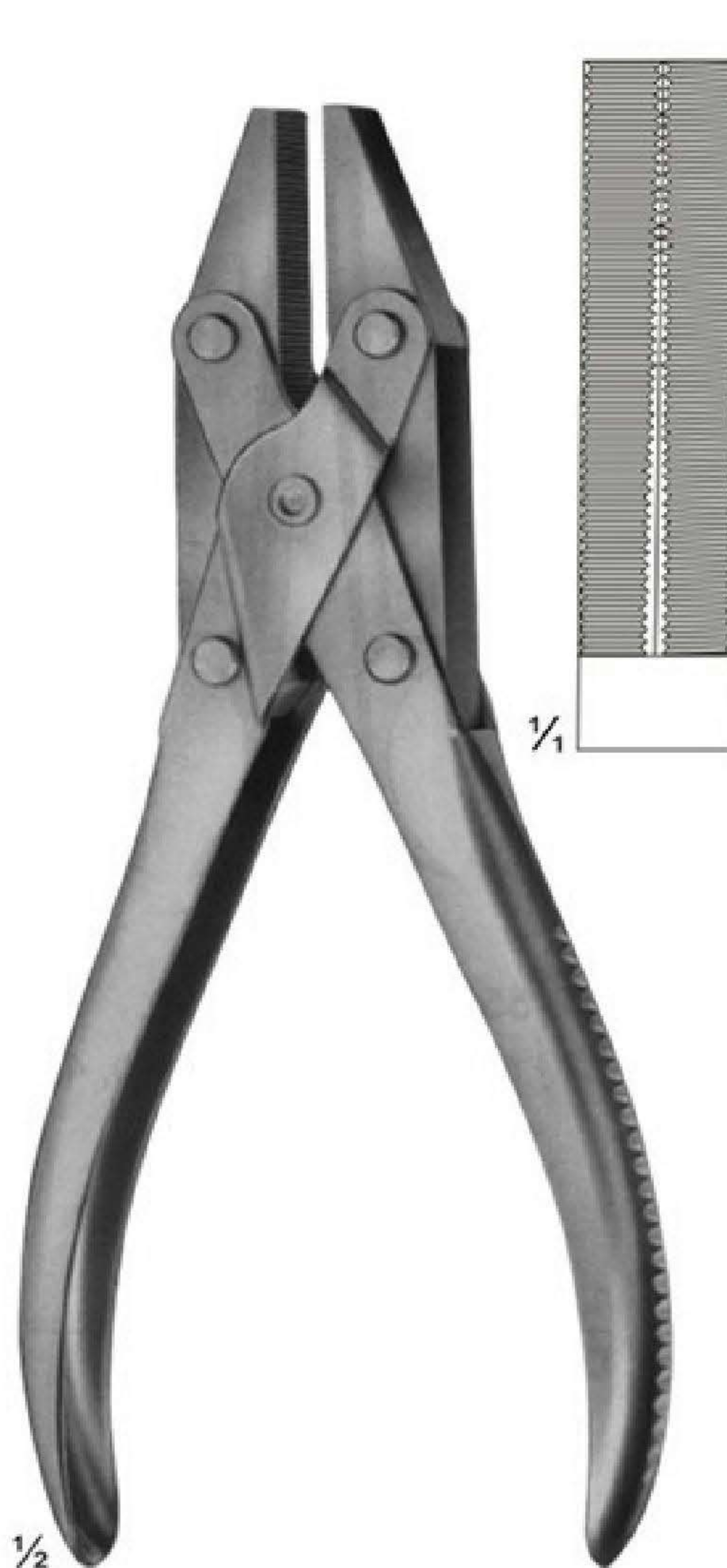

**06-8632**  
Flat-nosed pliers,  
parallel  
185 mm

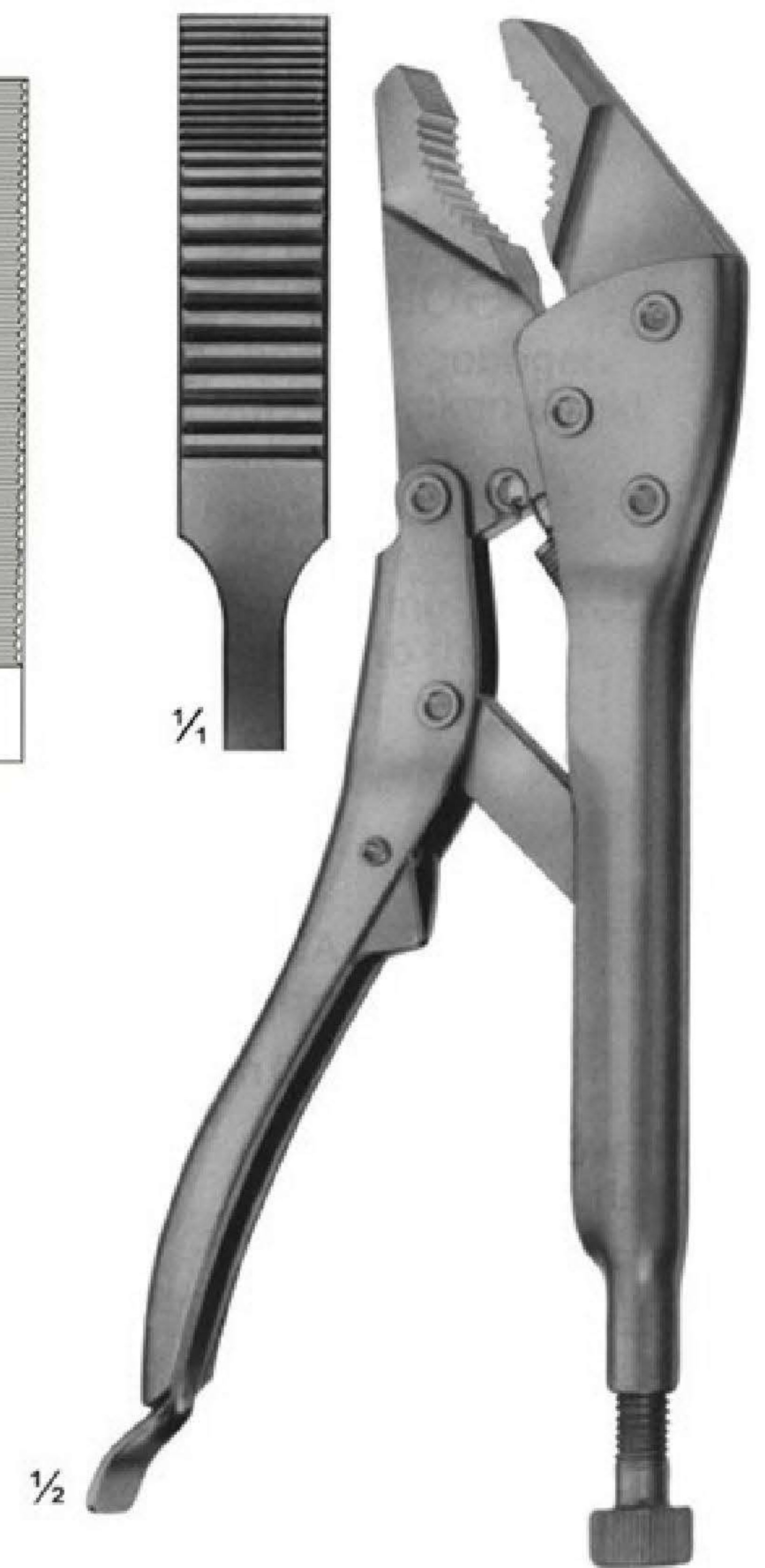

**06-8633**  
Vise grip  
200 mm

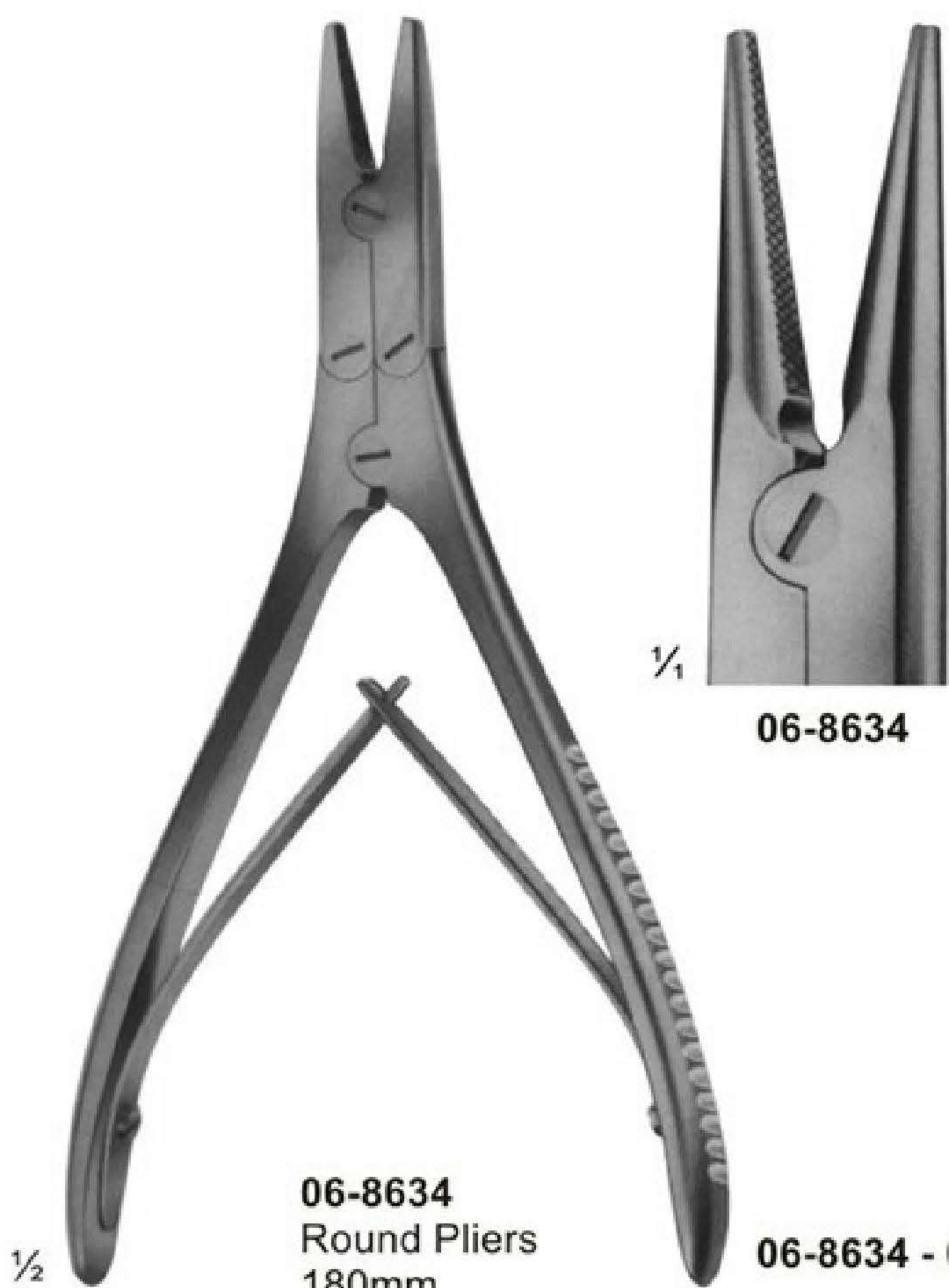

**06-8634**  
Round Pliers  
180mm

**06-8634 - 06-8637**

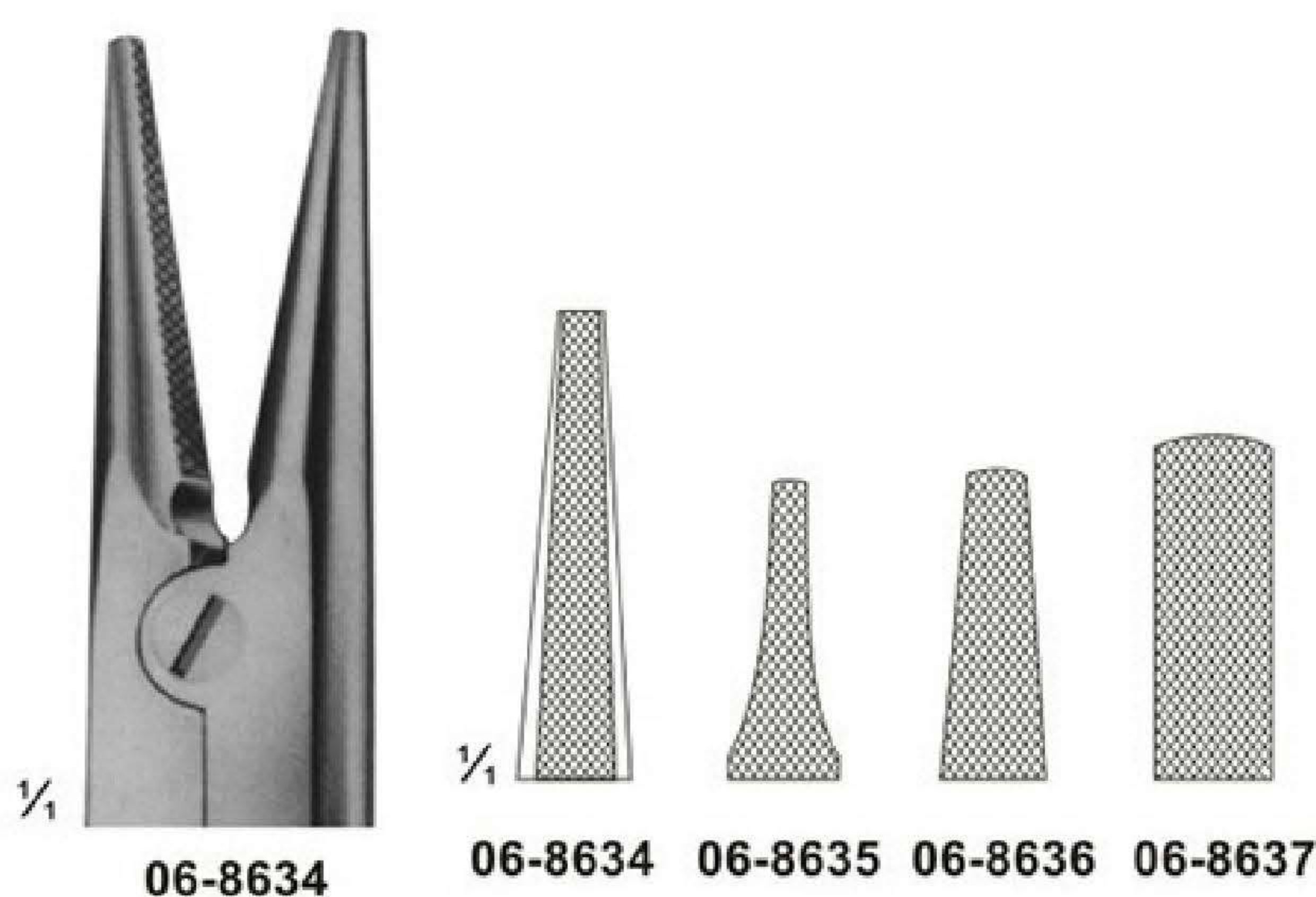

**06-8634**

**06-8634**

**06-8635**

**06-8636**

**06-8637**

**06-8635** 145 mm  
**06-8636** 180 mm  
**06-8637** 180 mm  
Extraction pliers for wires



**06-8638**  
Bending pliers  
for wires up to  
1.8 mm diam.



# Wire Cutters and wire Cutting Scissors DUROTIP with Carbide Cutting Edges



**06-8639**  
ANGLE  
130 mm

**06-8640**  
DUROTIP  
ANGLE  
130 mm

for soft wire  
up to diam. 0,5 mm  
for hard wire  
up to diam. 0,3 mm

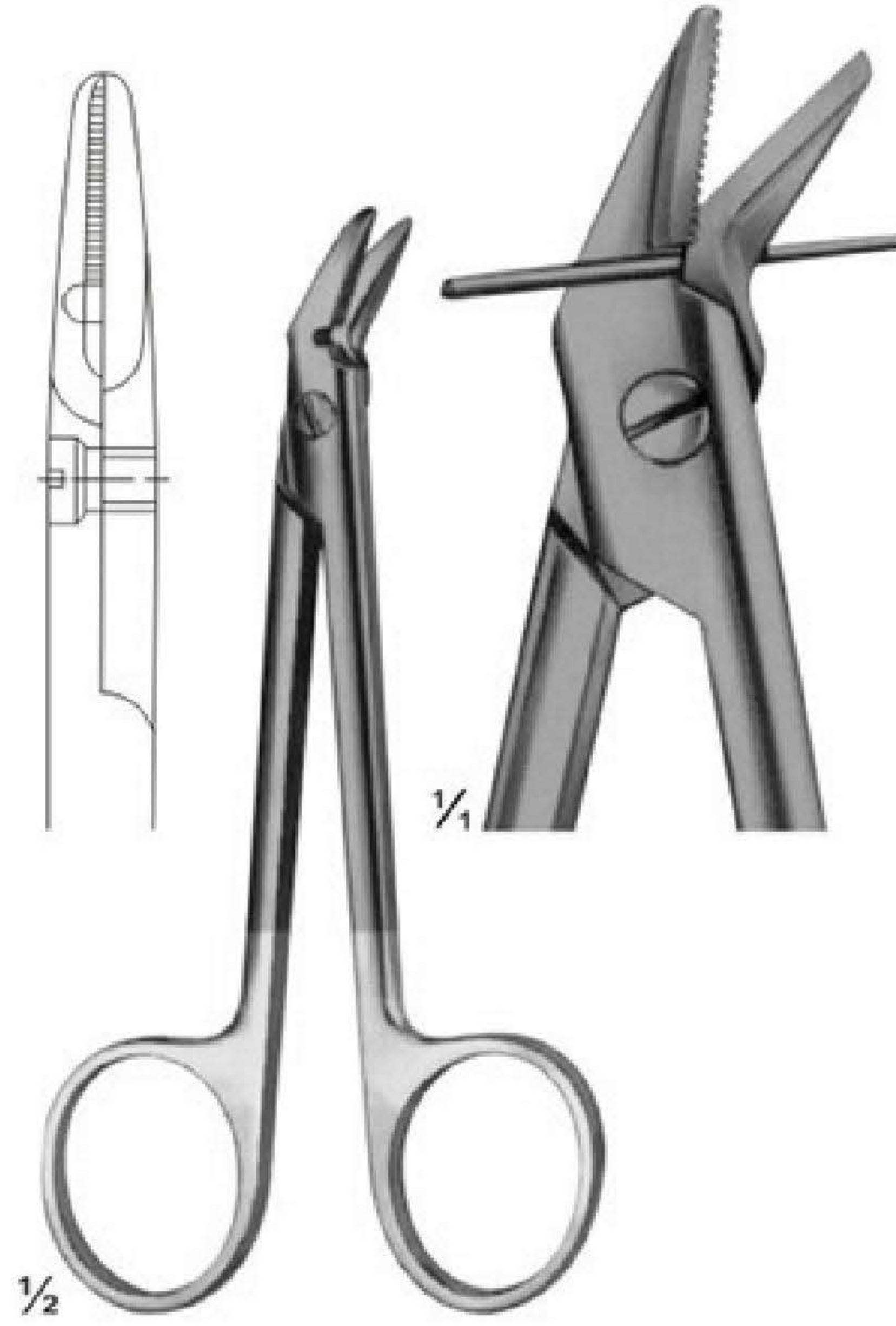

**06-8641**  
120 mm

**06-8642**  
DUROTIP  
120 mm

for soft wire  
up to diam. 1,2 mm  
for hard wire  
up to diam. 0,8 mm

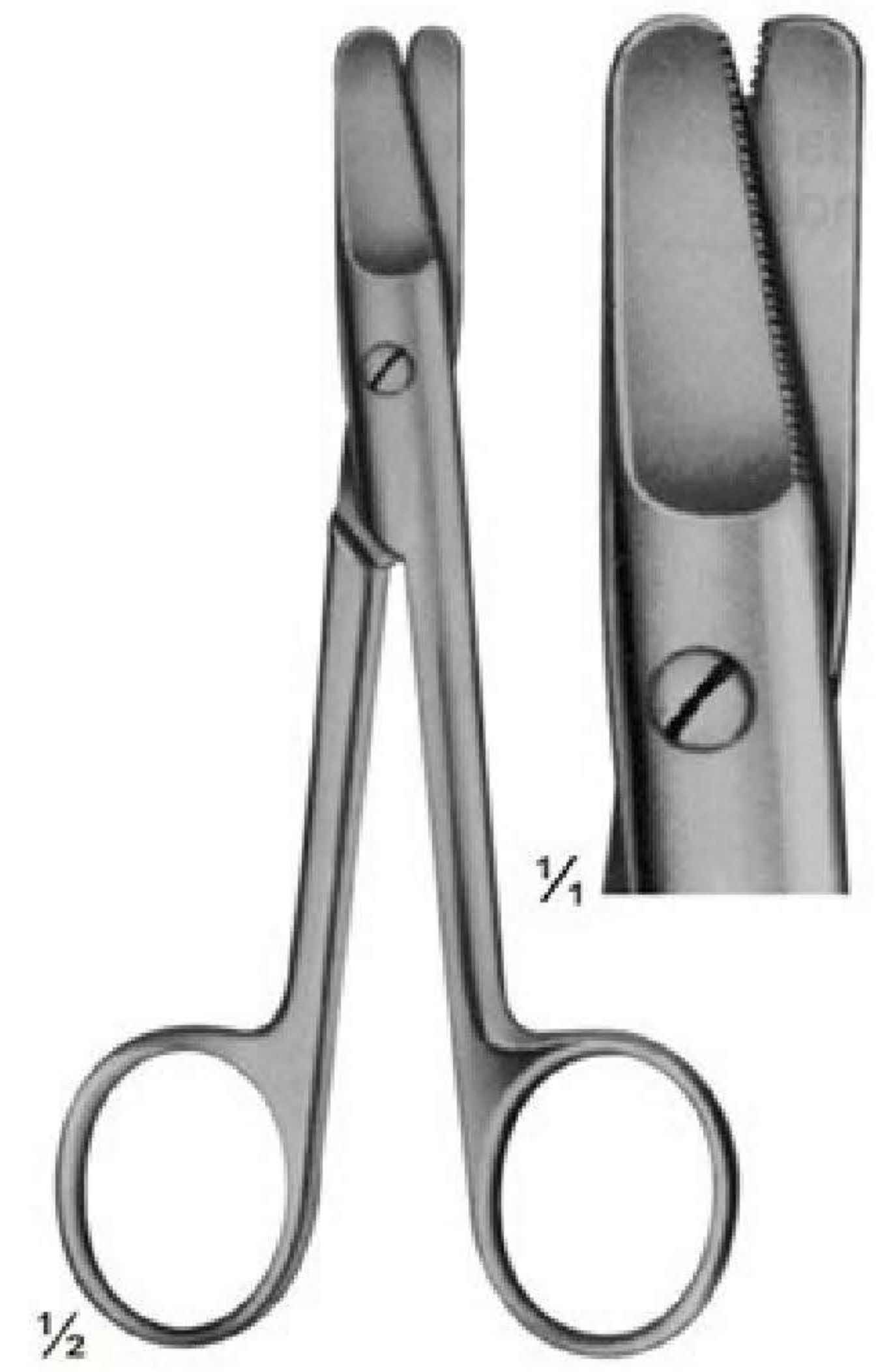

**06-8643**  
HARVEY  
125 mm

0,4 mm  
0,3 mm

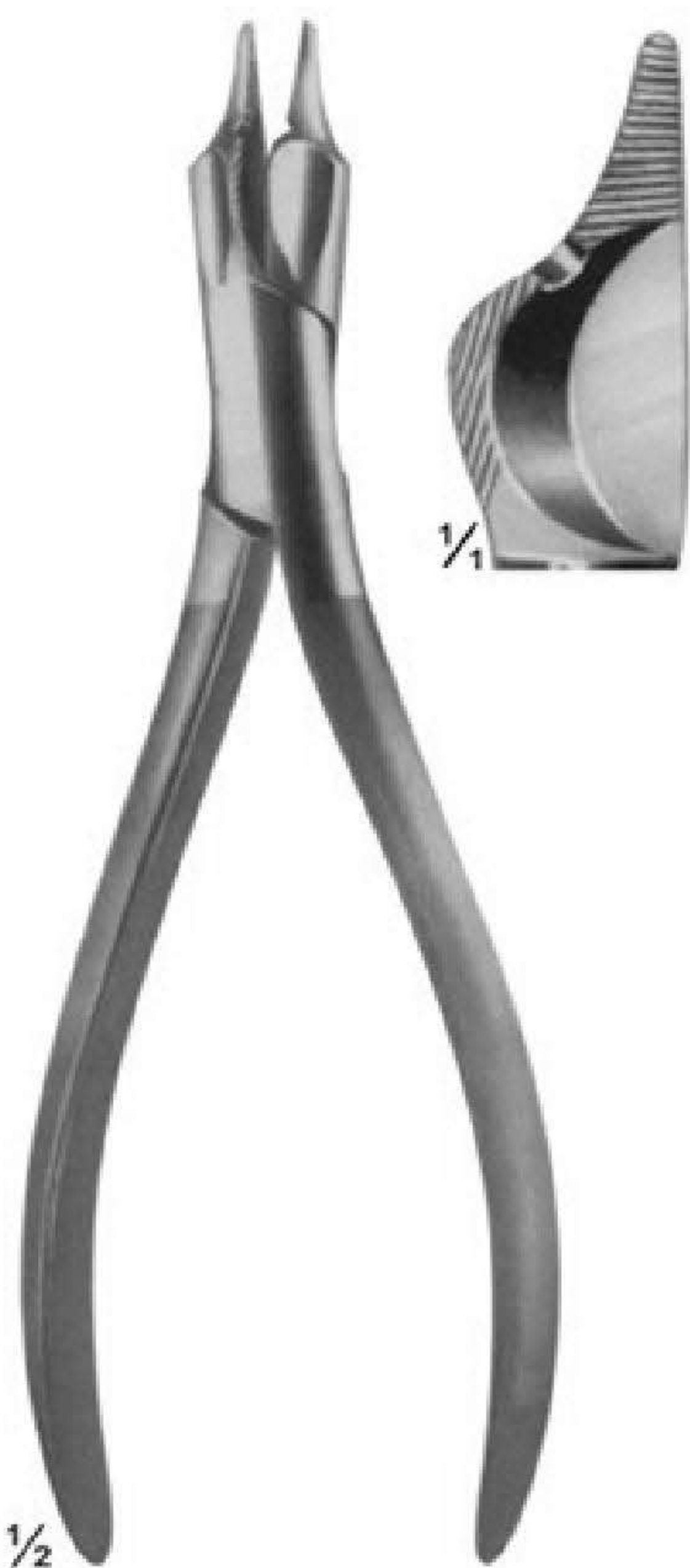

**06-8644**  
150 mm

for soft wire  
up to diam 1,5 mm  
for hard wire  
up to diam 1,0 mm



**06-8645**  
160 mm

1,5 mm  
1,2 mm



**06-8646**  
140 mm  
DUROTIP  
1,5 mm

1,0 mm

# Wire Cutting Pliers, Lateral Cutting Action



**06-8647**  
180 mm

for soft wire  
up to diam. 2,0 mm  
For hard wire 1,5 mm  
up to diam  
specially hardened  
cutting edges, front  
and lateral cutting  
action



**06-8648**  
REILL  
175 mm

for soft wire  
up to diam. 2,0 mm  
For hard wire 1,6 mm  
up to diam  
specially hardened  
cutting edges, for  
cutting off wires close  
to the bone



**DUROTIP**

**06-8649**  
235 mm

for soft wire  
up to diam. 3,0 mm  
For hard wire 2,2 mm  
up to diam

# Wire Cutting Pliers, Lateral and Front Cutting Action



**06-8650**  
240 mm

for soft wire  
up to diam. 2,0 mm  
For hard wire  
up to diam. 1,6 mm



**06-8651**  
145 mm

for soft wire  
up to diam. 1,5 mm  
For hard wire  
up to diam. 1,0 mm

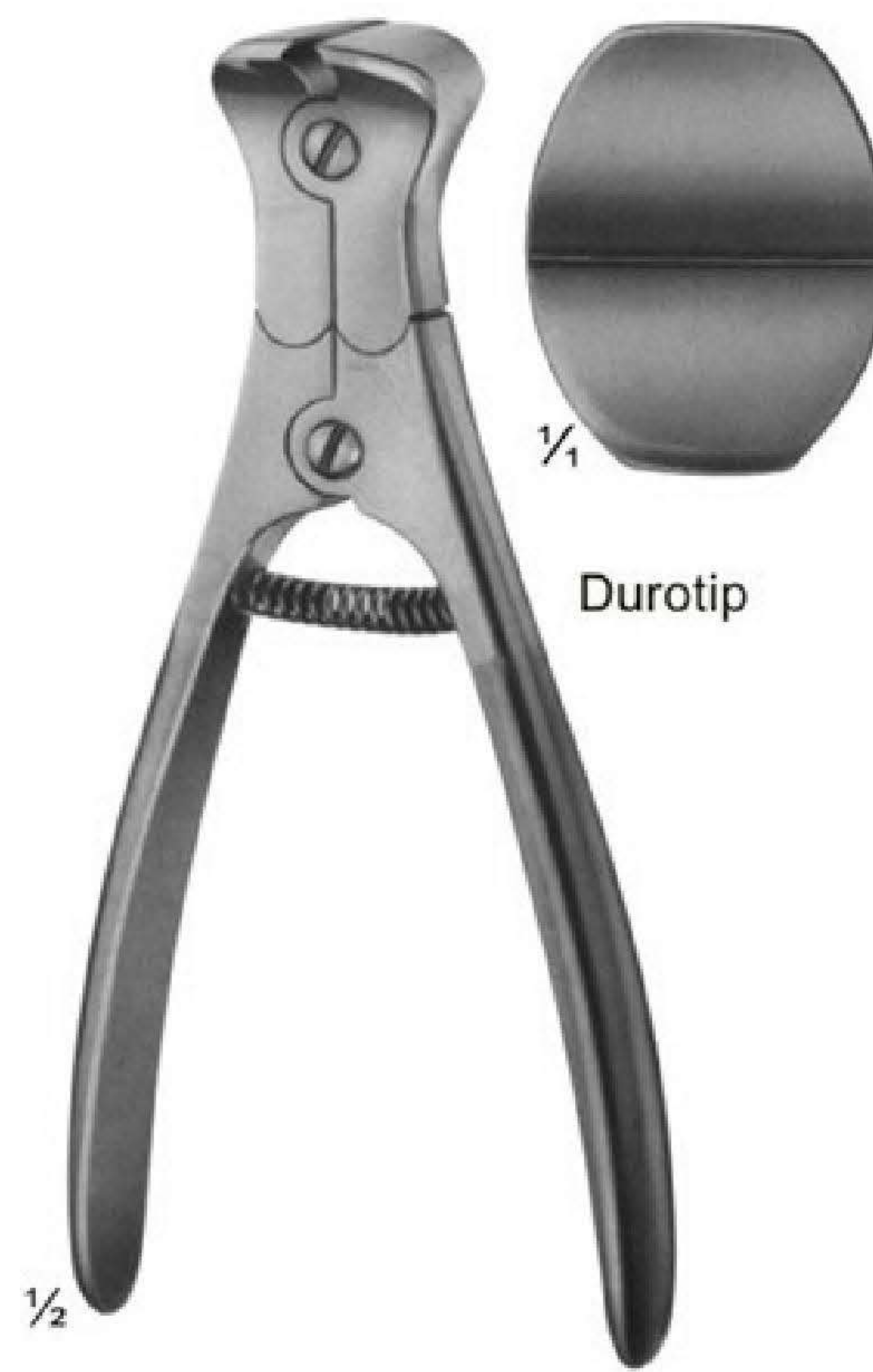

**06-8652**  
145 mm

for soft wire  
up to diam. 2,0 mm  
For hard wire  
up to diam. 1,5 mm



**06-8653**  
220 mm

for soft wire  
up to diam. 3,5 mm  
For hard wire  
up to diam. 2,5 mm

# Wire Cutting Pliers



**06-8654**  
320 mm

for soft wire  
up to diam. 3,0 mm  
For hard wire  
up to diam 3,0 mm

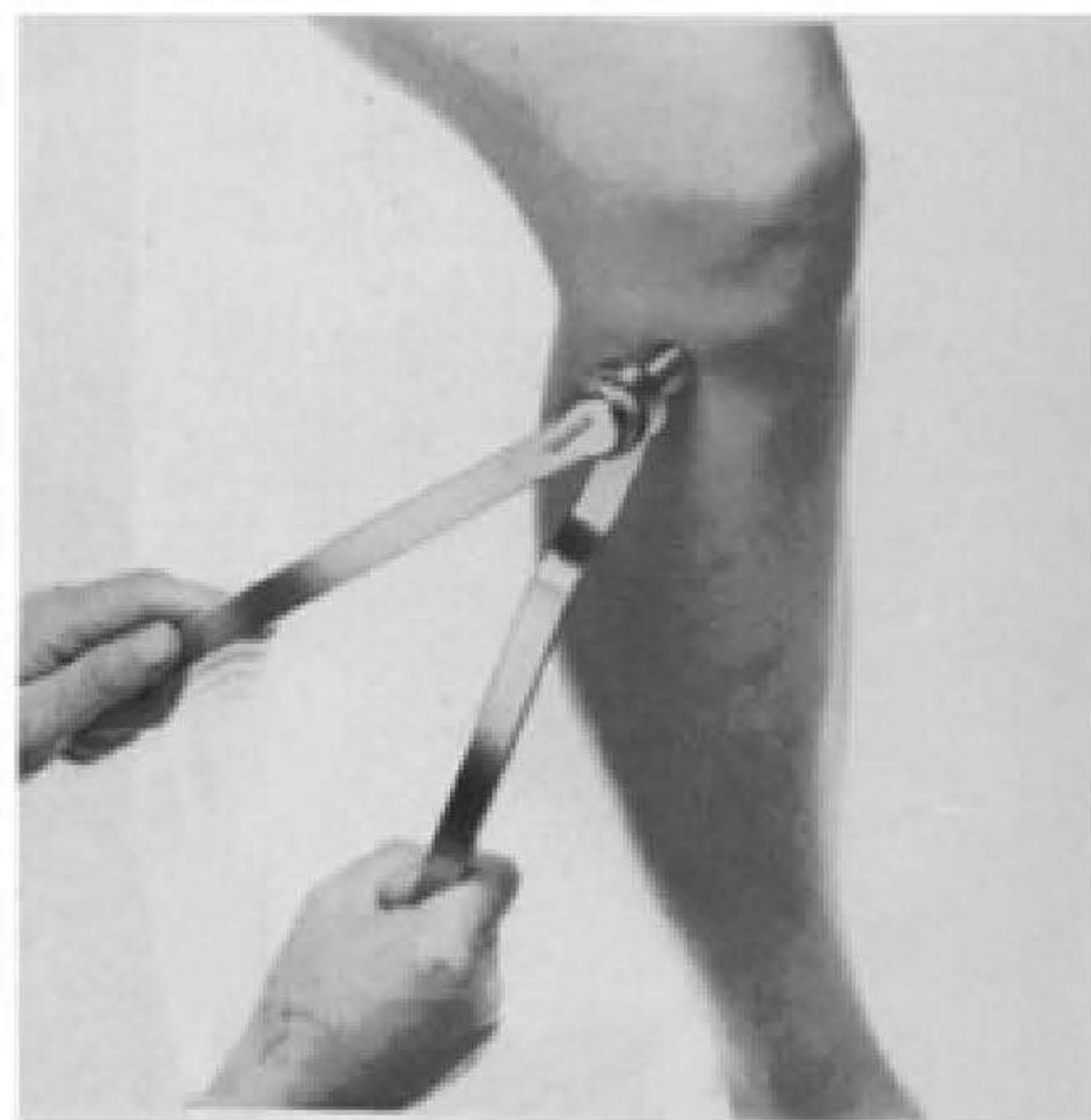

Cutter for cutting off  
KIRSCHNER wires,  
Tibia head screws,  
bolts, pins, up to 3 mm diam.



**DUROTIP**

**06-8655**  
Cutter for cutting off  
KIRSCHNER wires,  
Tibia head screws,  
bolts, pins, up to 6 mm diam.  
470 mm

# Finger Nail Instruments

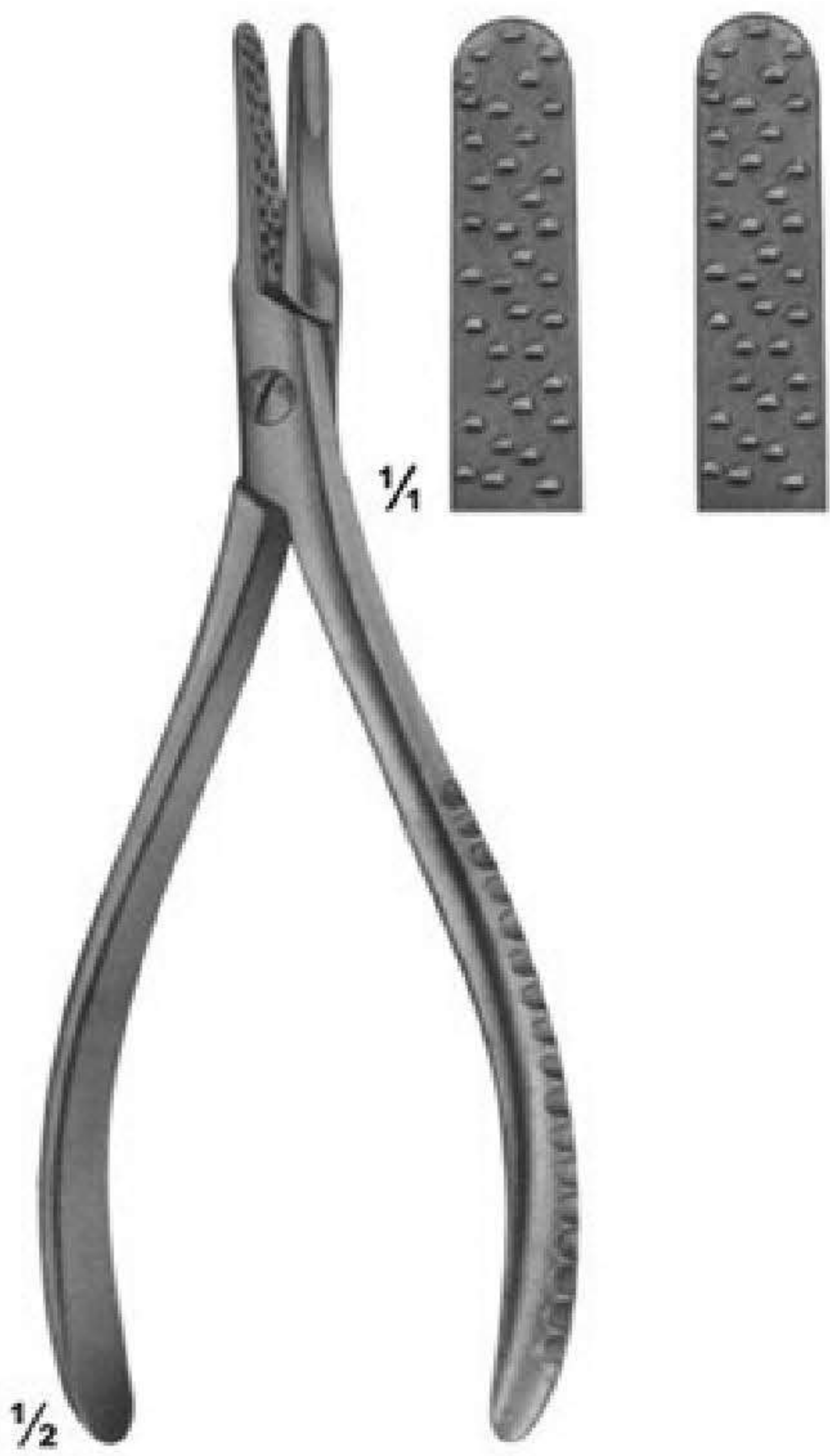

**06-8656**  
 Nail extracting  
 forceps  
 135 mm



**06-8657**  
 Nail extracting  
 forceps  
 145 mm

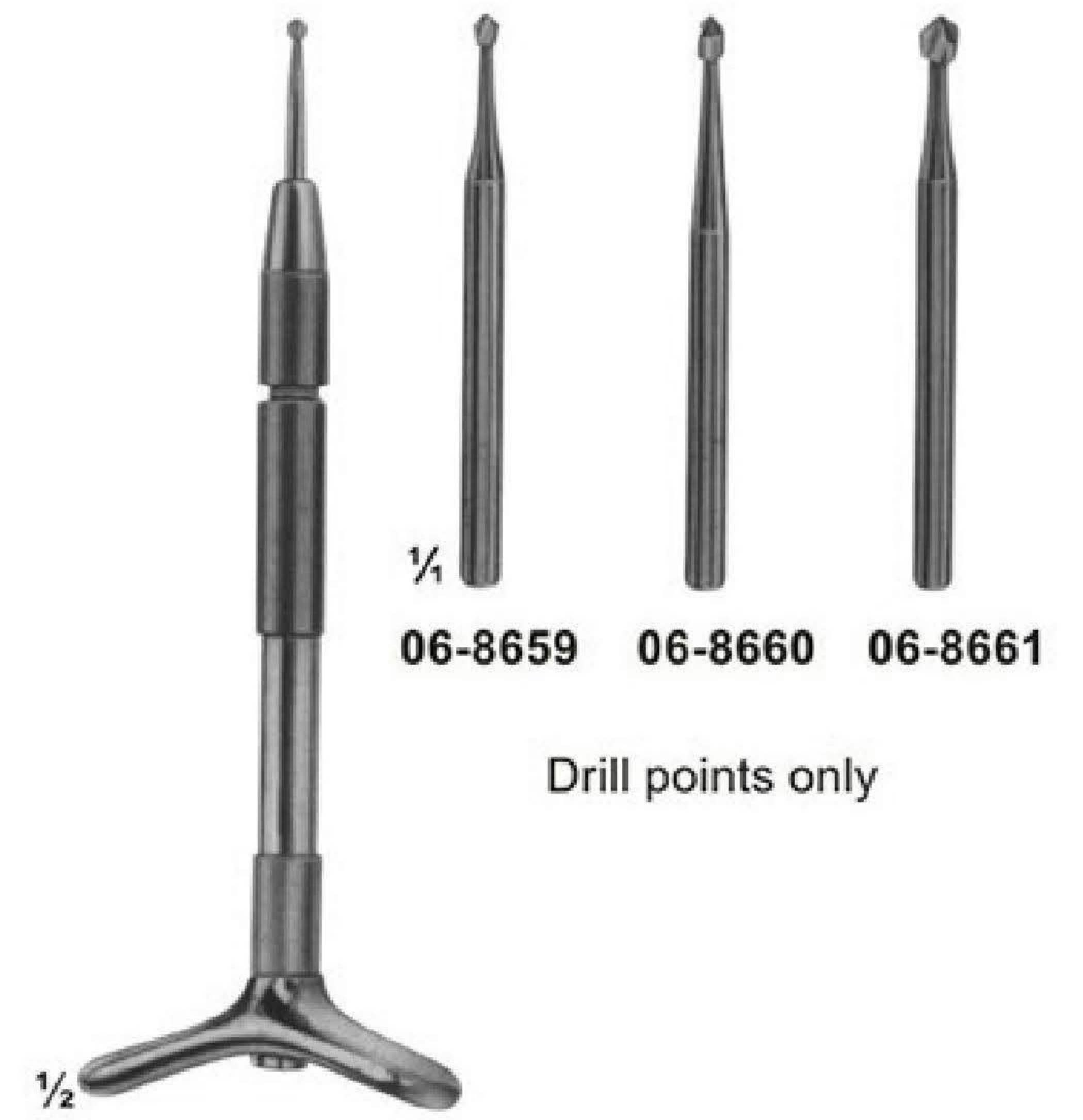

**06-8658**  
 Finger nail drill  
 with 3 drill points

06-8659 06-8660 06-8661  
 Drill points only

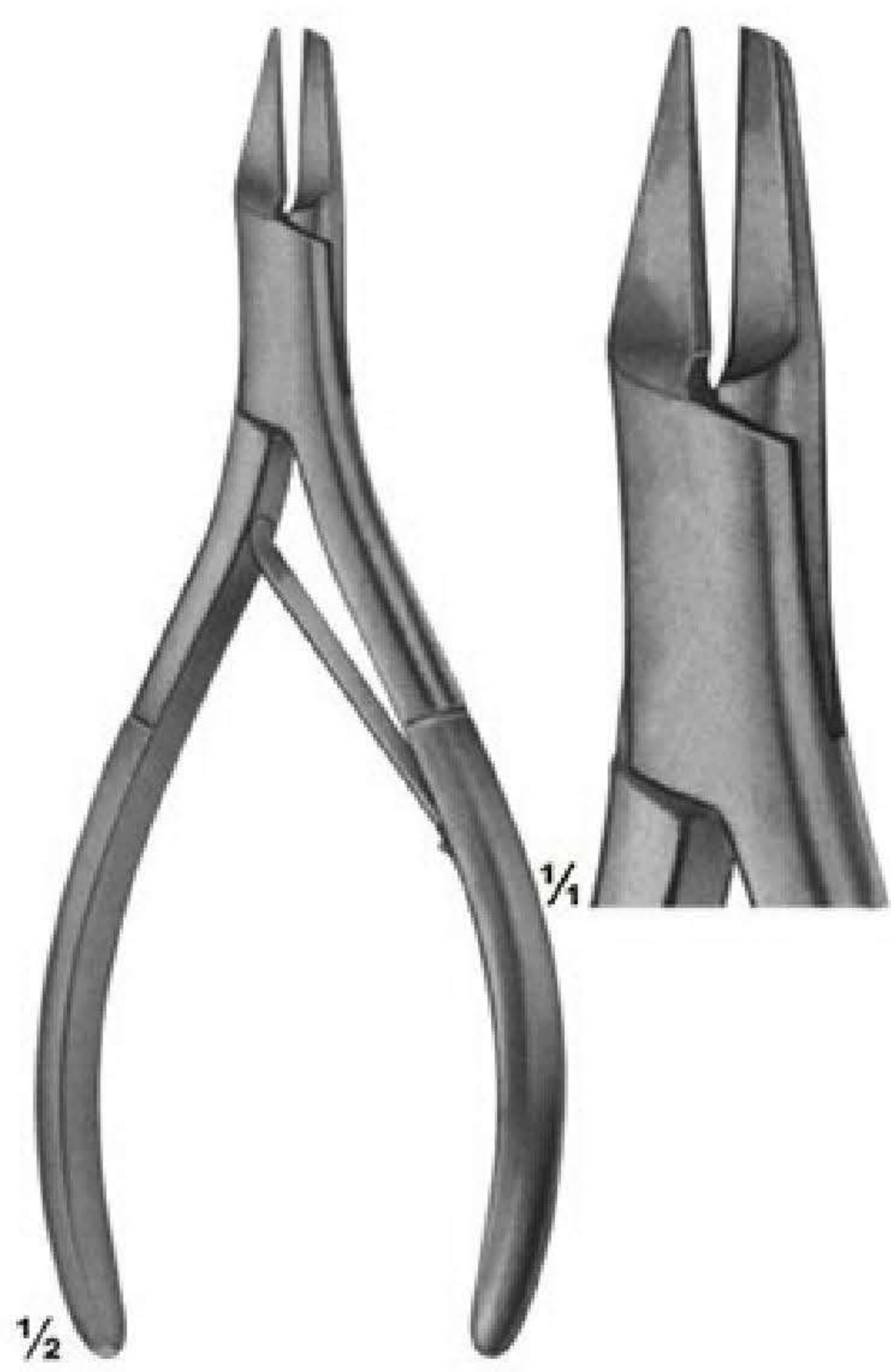

**06-8662**  
 Nail splitting  
 forceps  
 135 mm

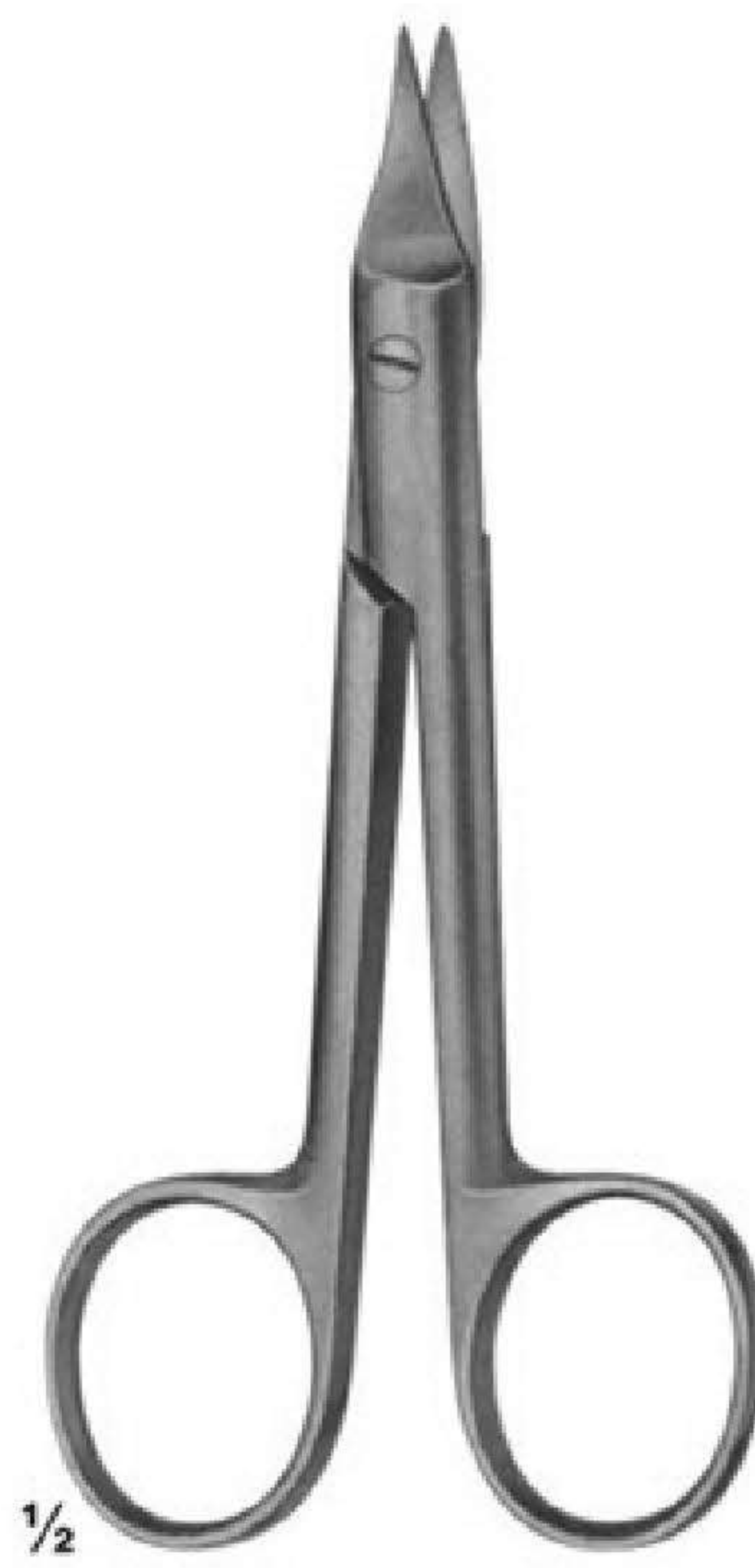

**06-8663**  
 SYSTRUNK  
 Scissors, for splitting  
 finger nails  
 130 mm



**06-8664**  
 Finger ring saw  
 150 mm

Spare blade  
 06-8665